



MC

mid continent.
CABINETS

SIGNATURE SERIES

Price & Specification Guide

August 2024

SUPERSEDES ALL PRIOR VERSIONS

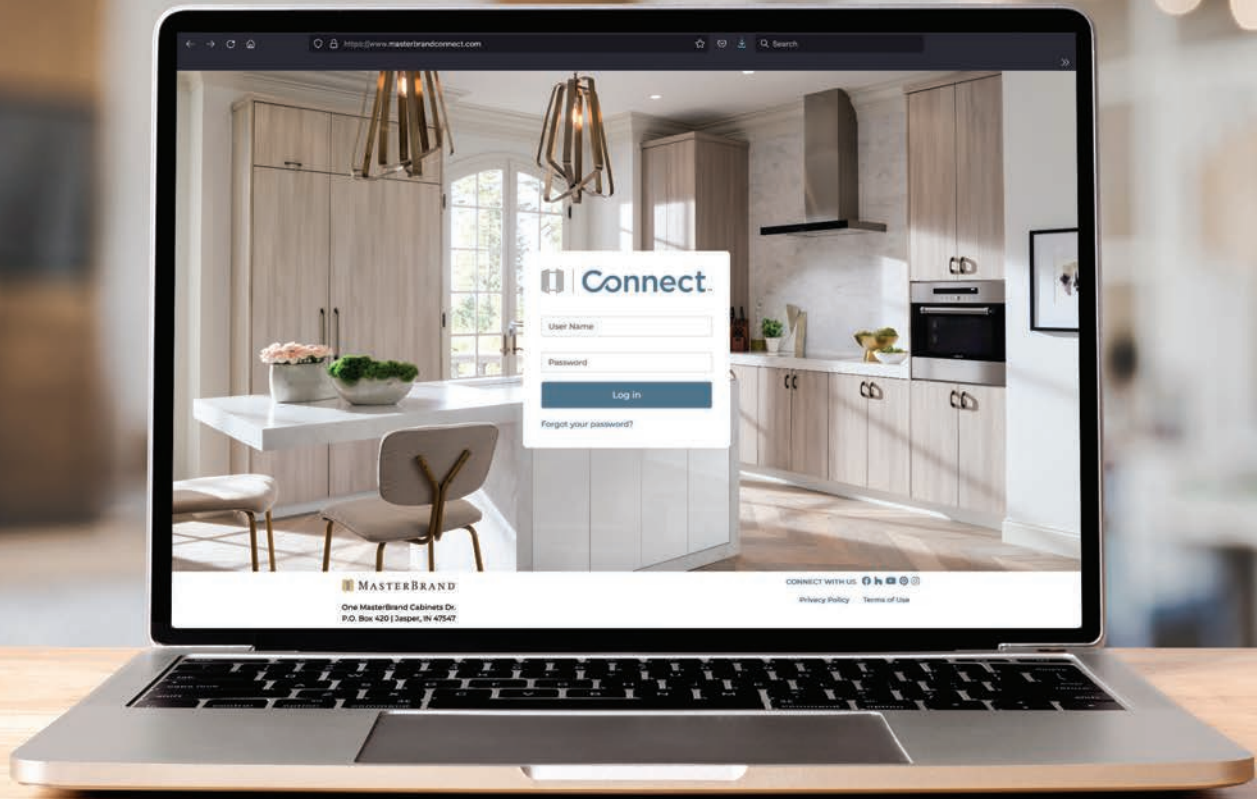

Your Destination for a Next-Level Customer Experience

MasterBrand Connect™ is a one-stop information portal aimed at enabling you to be in the driver's seat of your success. Within Connect, you have access to personalized dashboard content, improved order tracking, customer service case visibility, and much more. The result is an easy to navigate system with must-have information at your fingertips.

Feature Highlights:

- ✓ Mobile-friendly design with improved navigation and easier-to-use interface
- ✓ Unique log-ins per user with personalized content and preferences
- ✓ Improved search capability including POs and acknowledgement numbers
- ✓ Customer Service case visibility
- ✓ More timely order tracking with connected order visibility
- ✓ Communication preference selections
- ✓ Self-service account changes like phone, address and email



Check it out today at masterbrandconnect.com, or scan the code.

If you do not have a MasterBrand Connect account, please contact your Sales Representative to sign up.

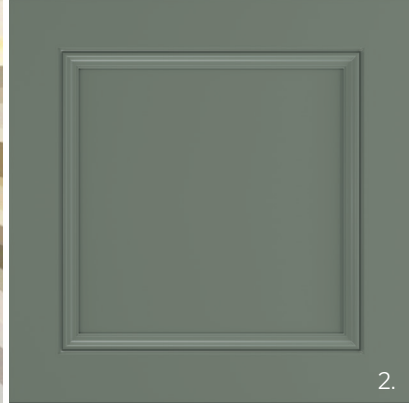
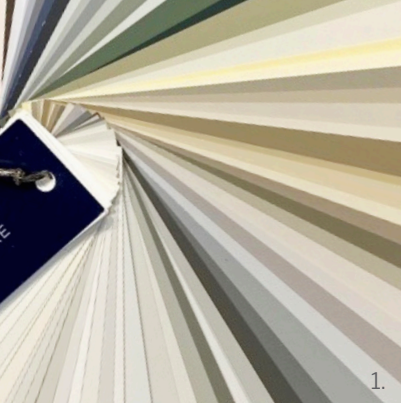

ELEVATE Your Experience

YOUR GUIDE TO WHAT'S JUST IN

AUGUST 2024

Indulge in all that's new for Mid Continent®. You'll find inspiring new finishes, a trend-forward door style, and a variety of new SKUs at your fingertips to bring fashionable and functional designs to life.

LET'S JUMP IN.

COLOR BY NUMBER

1. Achieve the color vision of your mind's eye with Mid Continent's new Color By Number program! This program includes any color in the Sherwin-Williams® and Benjamin Moore® paint families, giving you thousands of choices to create your unique space.

● Signature Series – Maple and MDF

NEW PAINT FINISHES

2. RETREAT PAINT

● Signature Series – Maple

● Pivot Series – Painted Hardwood

(Launched March 2024 in Pivot Series)

3. MARCONA PAINT

● Signature Series – Maple and MDF

NEW STAIN FINISH

4. COASTLINE STAIN

● Pivot Series – Oak and Maple

NEW DOOR STYLE

5. HENRI

● Signature & Pivot Series

(Launched March 2024 in Pivot Series)

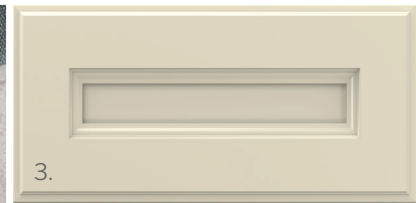



NEW WOOD HOODS

(Launched March 2024 in Pivot Series)

ARTISAN STRAIGHT WOOD HOOD

S **P** Signature & Pivot Series

WATERFALL WOOD HOOD

S **P** Signature & Pivot Series

CRAFTSMAN STRAIGHT WOOD HOOD

S **P** Signature & Pivot Series

SIGNATURE MANTEL WOOD HOOD

S **P** Signature & Pivot Series

NEW SKUS

(Launched March 2024 in Pivot Series)

120" TALL PANELS, SKINS & FILLERS

P Pivot Series

CHANGES TO MAKE NOTE OF:

PAQUETTE DOOR AND DRAWER FRONT CHANGE

S Signature Series

Changed to Flat Panel with DPSRR option and reduced price by 1 price column.
Drawer Front Rail Inside Profile changed to match door inside profile.

CPES MOULDING

S Signature Series – Rustic Hickory

P Pivot Series – Cherry, Maple, Oak, PureStyle and Laminate

RECESSED TOEKICK MODIFICATION AVAILABILITY

REMOVED FROM CORNER CABINET SKUS

S **P** Signature & Pivot Series

FOXHALL GREEN TO HAVE MATCHING

LAMINATE ENDS ON STANDARD CONSTRUCTION

S Signature Series

108" PANEL ADDED INCREASED DEPTH

S **P** Signature & Pivot Series



TABLE OF CONTENTS

Door and Finish OptionsF
 Construction Features1
 Modification/Upgrade Compatibility Chart2
 Construction Upgrades3
 Drawer Front Options4-5
 Door Options6
 Custom Modifications7-23
 Door Modification/Specialty Doors24-28
 Glass Inserts29-34
 Cabinet Dimensions35-44
 Design Checklist45
 NKBA Guidelines46-47
 Innovative Options Reference Chart48
 Wall Cabinets49-110
 Hearths111
 Base Cabinets112-169
 Universal Access Cabinets170-174
 Tall Cabinets175-210
 Office & Furniture Cabinets211-225
 Vanity Cabinets226-254
 Fillers255-262
 Panels & Skins263-272
 Wainscoting273
 Custom Panels, Doors, & Drawer Fronts274-276
 Custom Hinged Doors277-278
 Stacked Moulding Kits279-283
 Moulding284-293
 Valances293-294
 Embellishments294-303
 Contemporary Embellishments304
 Shelves305-306
 Decorative Hardware307-310
 Cabinet Accessories311-316
 Roll Tray Kits317-318
 Stain, Paint, & Touch-up Tools318
 Guide Kits and Parts319
 Hinges320
 Doors, Drawer Fronts, & Drawers321
 Miscellaneous Parts321
 Index by Description322-325
 Index by Code326-327
 Policies/Agreements/Express Response

DOOR AND FINISH OPTIONS

This section contains information regarding the global options you will choose that will apply to your entire order: species/material characteristics, door options, and finish options.

CHARACTERISTICS OF WOOD TYPES

No matter which species you choose for your new kitchen or bath cabinetry, please keep in mind that no two pieces of wood are exactly the same. Stains are likely to exaggerate the difference between open and closed grains and other markings in wood. Grain variation and color change should be expected. As hardwood ages, it will darken when exposed to different types of light. Color differences or changes in wood can also be caused by exposure to harsh chemicals, extreme heat or moisture. Additionally, wood species exhibit other defining characteristics, such as mineral deposits/streaks, knots, sap runs, pin holes and wormholes. These markings make the wood unique and contribute to its enduring beauty.

Cherry is characterized by its red undertones, but may vary in color from white to a deep, rich brown. Cherry is a close-grained wood with fairly uniform texture, revealing pin knots and curly graining. All wood will age with time and the finish will darken. This is especially true for Cherry. This is a sought-after quality in Cherry cabinetry, and those who select it expect this evolution.

Maple is a close-grained hardwood that is predominately white to creamy-white in color, with occasional reddish-brown tones. While Maple typically features uniform graining as compared to other wood species, characteristic markings may include fine brown lines, wavy or curly graining, bird pecks and mineral streaks. These traits are natural and serve to enhance Maple's natural beauty.

Oak is a strong, open-grained hardwood that ranges in color from white to pink and reddish tones. Streaks of green, yellow and even black may appear due to mineral deposits. Oak may also contain wormholes and wild, varying grain patterns. This distinct graining is considered a desirable quality.

CHARACTERISTICS OF RUSTIC WOOD TYPES

***Rustic Alder** is characterized by its light brown and reddish undertones and may contain a variety of pin holes, open and closed knots of various sizes and colors, small cracks, bird pecks, mineral streaks, and grain variation. Some knots may have small holes through the panel. In addition, the wood will contain color difference caused by variations in minerals found in the soil, creating visible mineral tracks. It is slightly softer than Maple and Cherry and stains beautifully, thus its appeal.

***Rustic Hickory** is a strong, heavy hardwood known for distinctive graining patterns. Color will vary from nearly white to dark brown, with wild flowing grain patterns and dramatic color variations. Rustic Hickory can have a fine uniform grain to large knots appearing black and brown in color of various shapes and sizes, sapwood, mineral and some checking.

Sound Closed Knot (not moveable) – Expected up to approximately 3" in diameter

Sound Knot with Cracks – Expect sound knots with open cracks up to approximately 1" in length

Open Knot (through door) – Expected with open area up to approximately 3/4" in diameter

Note: 3/4" diameter is about the size of a penny. Holes created by open knots pass completely through the door and are desirable for this rustic look.

Unsound Knot (moveable core) – Not to be expected

Knot Cluster (cluster of tight sound knots) – To be expected (more prevalent in Rustic Alder)

Worm Holes/Pin Holes (can go through the door) – Can be expected up to approximately 1/4" in diameter

Worm Tracks – Can be expected in sizes up to approximately 1/8" wide by 8" long

*Doors, drawer fronts, and selected trim items will feature rustic characteristics. Other areas of the product will utilize standard Alder or standard Hickory, respectively.

CHARACTERISTICS OF MDF

MDF (Medium Density Fiberboard) is an engineered wood product that is composed of wood fibers and resin that are then compressed to create a smooth uniform surface with a consistent core. Painted MDF eliminates the appearance of naturally occurring wood characteristics such as grain patterns, knots or mineral streaks, and is more resistant to warping, expanding and contracting due to environmental changes than solid hardwoods.

CHARACTERISTICS OF SPECIALTY LAMINATE

Specialty Laminate features design leading, high definition wood grain or high gloss laminates on doors, drawer fronts, overlay fillers, and Premium trim items. The surfaces are laminate based materials with an integrated top coat that provides superior beauty, durability, and performance. The core panel material is made of MDF to ensure a consistent and stable product.

Additional coordinating trim items in the cabinet box color are also available. Grain characteristics will vary across laminated parts to mimic natural wood grain patterns. A heat shield is required to separate all laminate products from heat producing units to be in compliance with cabinet warranty.

CHARACTERISTICS OF PURESTYLE™

PureStyle™ is the process of wrapping durable laminate materials around door frames and select trim and premium mouldings resulting in products with crisp styling features and a surface that provides abrasion resistance. PureStyle™ products are wrapped (versus form pressed onto a Medium Density Fiberboard (MDF) slab like thermofoil) and have a clear, integrated top coat for superior durability. The lineals and core panel material are made of MDF to ensure a consistent and stable product.

These doors offer the durability of a laminate and the beauty of paint and finished wood while bringing peace of mind to those who care about creating a better environment—both inside and outside of their homes.

Textured wood grain PureStyle™ doors feature design leading, high definition wood grain laminates on doors, drawer fronts, overlay fillers, and Premium trim items. The surfaces are laminate based materials with an integrated top coat that provides superior beauty, durability, and performance. The core panel material is made of MDF to ensure a consistent and stable product. Additional coordinating trim items in the cabinet box color are also available.

A heat shield is required to separate all PureStyle™ products from heat producing units to be in compliance with cabinet warranty.

In Species Availability charts and notes throughout book, PureStyle™ will be referred to as Laminate.

In keeping with our practice of continuous product improvement and/or to maximize efficiencies, Mid Continent® Signature™ Cabinetry may adjust specifications in design and materials as it deems necessary. Where differing materials are utilized, they will be of similar or better quality in keeping with Mid Continent Signature Cabinetry's commitment to quality.

Door Style Price Point Reference Chart

Your Mid Continent® Signature™ price guide contains charts with prices for each cabinetry product, arranged according to a numerical code. Use the chart below to determine the price code for your preferred cabinetry style.

	Cherry	Maple	MDF	Oak	Rustic Alder	Rustic Hickory	PureStyle™	Specialty Laminate
Albany								7
Berkley FO		5						
Berkley PO		4						
Brawny FO	7	5	5	4	7	7		
Celina	11	10						
Danielson	9	8	8					
Dapper FO	7	5		4		7		
Dayton								7
Detailed FO	7	5						
Detailed PO	6	4						
Garland	10	9						
Gilmore								7
Glyndon	5	3			5			
Healy	12	11				12		
Henning							9	
Henri 	5	3						
Jasper	9	8						
Paquette	11	10						
Payson	8	6		5	8	8		
Perry FO	7	5						
Rohe	10	9						
Sanford	9	7						
Simple FO	5	3	3	2	5	5		
Simple PO		2		1	4	4		
Slab FO	5	3	3					
Slim FO	5	3		2				
Slim PO	4	2		1				
Stevenson FO	10	9						
Traditional FO	6	4		3				
Traditional PO	5	3		2				
Windsor		6						
Witten FO	8	6		5	8	8		
Witten PO	6	4		3	6	6		

Anywhere you see  will take you directly to this page.

To return to your product page, just click the  button.

FULL OVERLAY DOOR STYLES

F4

DOOR STYLES

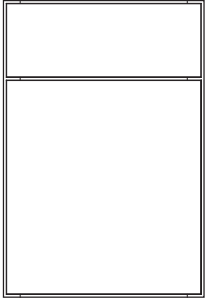

Albany

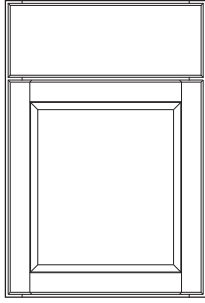

Berkley FO

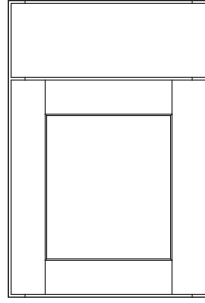

Brawny FO

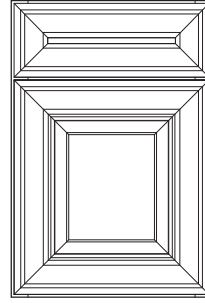

Celina

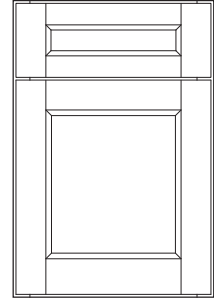

Danielson

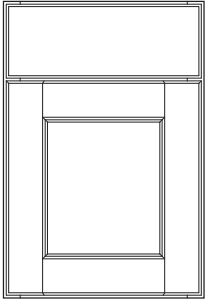

Dapper FO

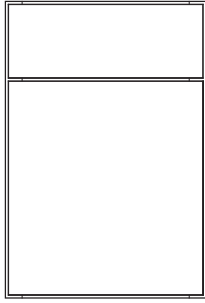

Dayton

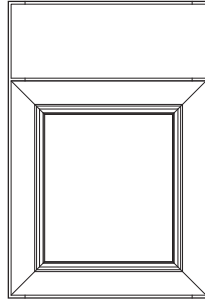

Detailed FO

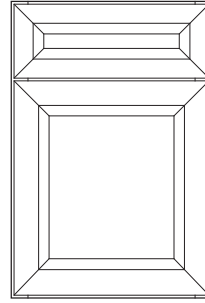

Garland

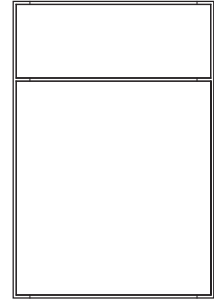

Gilmore

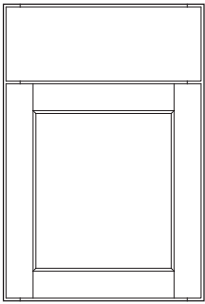

Glyndon

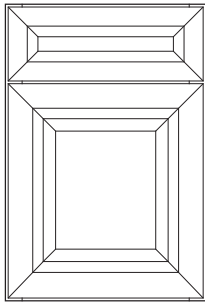

Healy

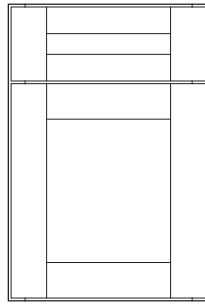

Henning

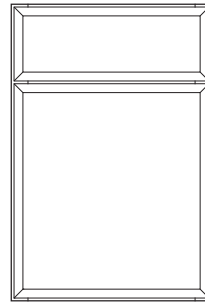

Henri **NEW**

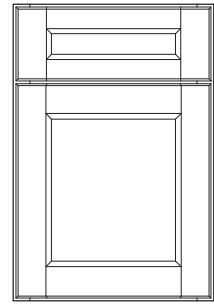

Jasper

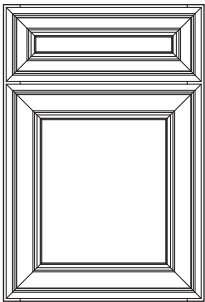

Paquette

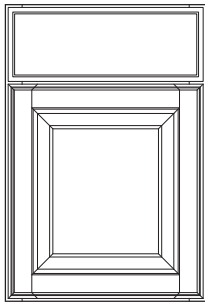

Payson

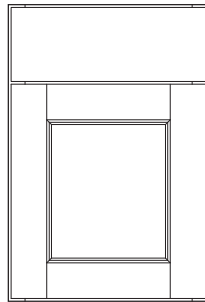

Perry FO

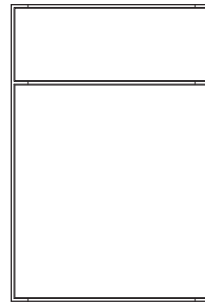

Rohe

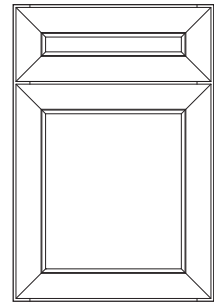

Sanford

FULL OVERLAY DOOR STYLES (cont'd)

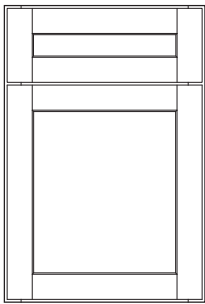

Simple FO

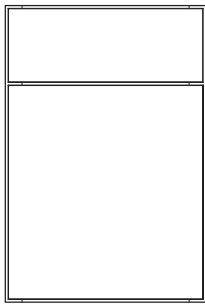

Slab FO

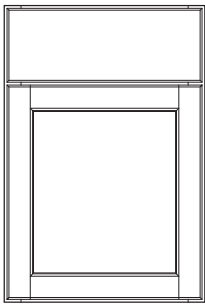

Slim FO

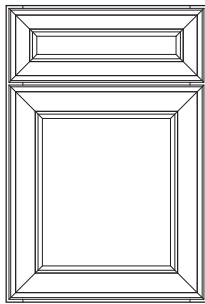

Stevenson FO

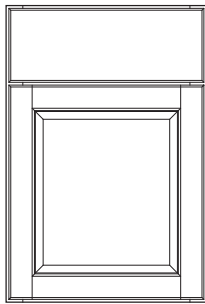

Traditional FO

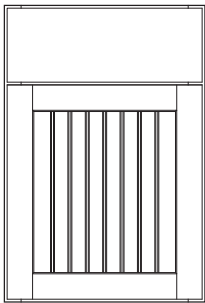

Windsor

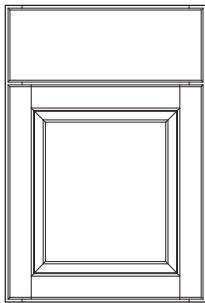

Witten FO

PARTIAL OVERLAY DOOR STYLES

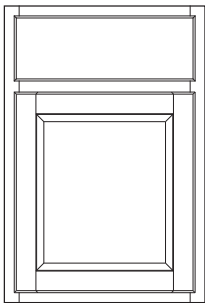

Berkley PO

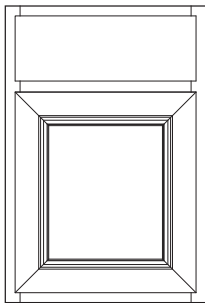

Detailed PO

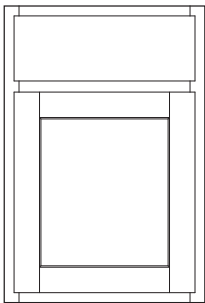

Simple PO

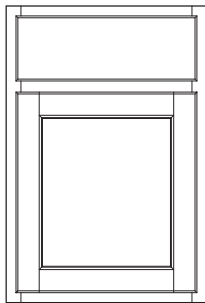

Slim PO

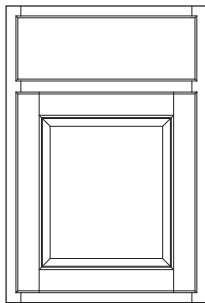

Traditional PO

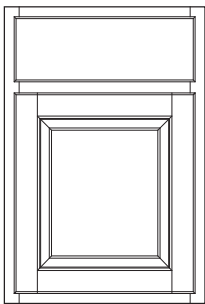

Witten PO

OVERLAY SPECIFICATIONS

F6

DOOR STYLES

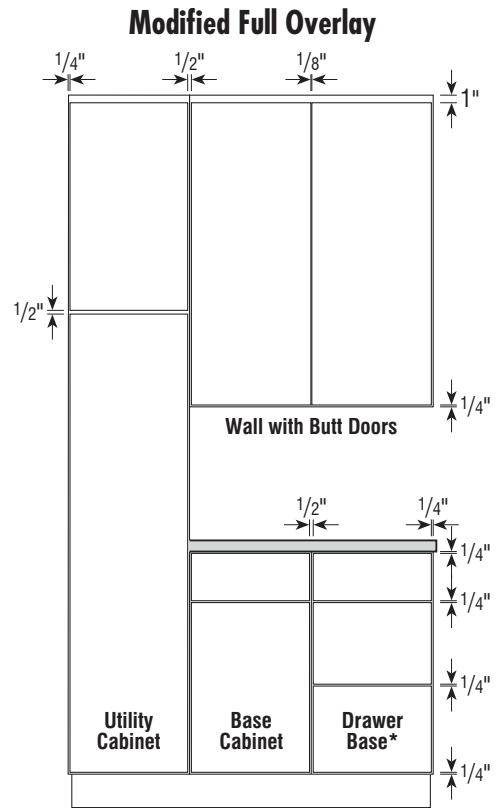
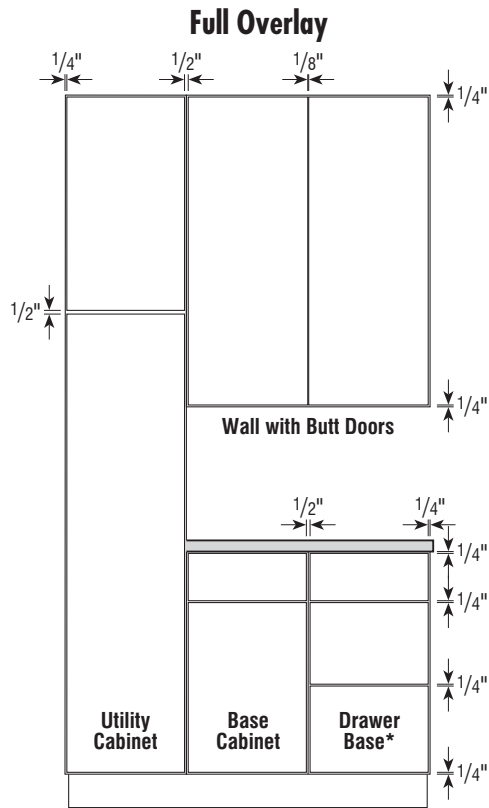

Full Overlay

The door and drawer fronts overlay the frame, exposing 1/4" on the top and bottom rails and right and left stiles of base cabinets. Typical base units with a center stile expose 1/2" of that stile.

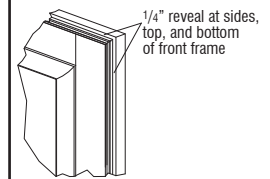

Full Overlay

Modified Full Overlay

Wall and Tall Cabinets: The door and drawer fronts overlay the frame exposing 1/4" on the bottom rail and right and left stile. One full inch is exposed on the top rail of wall and tall cabinets. Typical units with a center stile expose 1/2" of that stile.

Base Cabinets: The door and drawer fronts overlay the frame, exposing 1/4" on the top and bottom rails and right and left stiles of base cabinets. Typical base units with a center stile expose 1/2" of that stile.

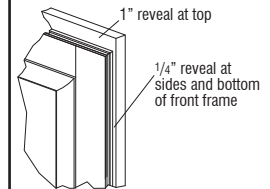

Modified Full Overlay (Wall and Tall)

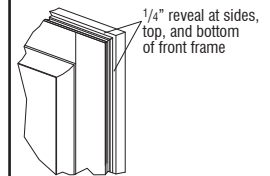

Modified Full Overlay (Base)

*34 1/2" high application shown. On 32" high Full Overlay three drawer applications (drawer bases and sink bases with drawers), the reveal above the bottom drawer front is 1/2".

- One double door center stile cabinet has the same reveal as two single door cabinets.

OVERLAY SPECIFICATIONS (cont'd)

Partial Overlay

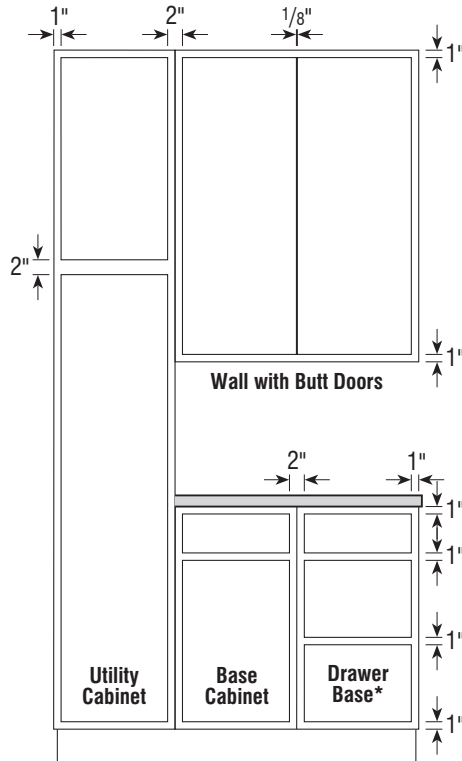

F7

DOOR STYLES

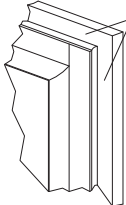
<p>Partial Overlay</p>	<p>The door and drawer fronts overlay the face frame 1/2", exposing 1" of the frame both on the stile and rail members. Typical wall and base cabinets with a center stile expose 2" of that stile.</p>	 <p>1" reveal at sides, top, and bottom of front frame</p>
<p>Exceptions on Face Frame Reveals</p>	<ul style="list-style-type: none"> • Some oven units have 3" stiles and 9" intermediate rails (designed for universal flexibility of cut-out options) that create various reveals. • Blind corner wall and base cabinets expose different center stile reveals. Diagonal corners also vary. • Please see the dimensional charts for oven units and blind bases located in those sections. 	

*On Partial Overlay 2DB__ (Two Drawer Bases), reveal above the bottom drawer front is 2".

DOOR STYLE SPECIFICATIONS

Cherry

- When Cherry door styles are ordered, it is recommended to apply a finished end option or a veneer end panel for exposed ends due to the natural aging of Cherry.

Maple

- When a Paint or Paint with Glaze finish is specified, the door and/or drawer front center panel may be constructed of Medium Density Fiberboard (MDF), except when Windsor door style or Heirlooming are specified. MDF provides a smoother finish when painted, and is more resistant to warping, expansion, and contraction. Doors, drawer fronts, and additional facings may consist of other hardwood components.

MDF

- MDF door styles will use Maple for trim and panels, refer to Maple in the Species Availability charts.

Rustic Alder & Rustic Hickory

- Doors, drawer fronts, and selected trim items will feature rustic characteristics. Other areas of the product will utilize standard Alder or standard Hickory, respectively.

High Gloss

- When Premium Panels are ordered in High Gloss, panels will not have grain.
- When WEP1230P, BEPP, and TEP_P panels are ordered in High Gloss, front of panel will be high gloss, back of panel will be white laminate, and edgbanding on front edge will match door and drawer front edgbanding selection.

All Door Styles

- All doors and drawer fronts are 3/4" thick unless otherwise noted.

Door and Drawer Front Side Profiles

- Veneer and MDF components are shown with gray shading on side profiles. Solid-wood components do not have shading.
- On MDF door styles, all door and drawer front components will be in MDF.

Wood Grain

- Simple FO DFF5PCNR and Windsor have a vertical grain direction on the drawer front center panel.
- See reference images for wood grain direction on all other door styles.

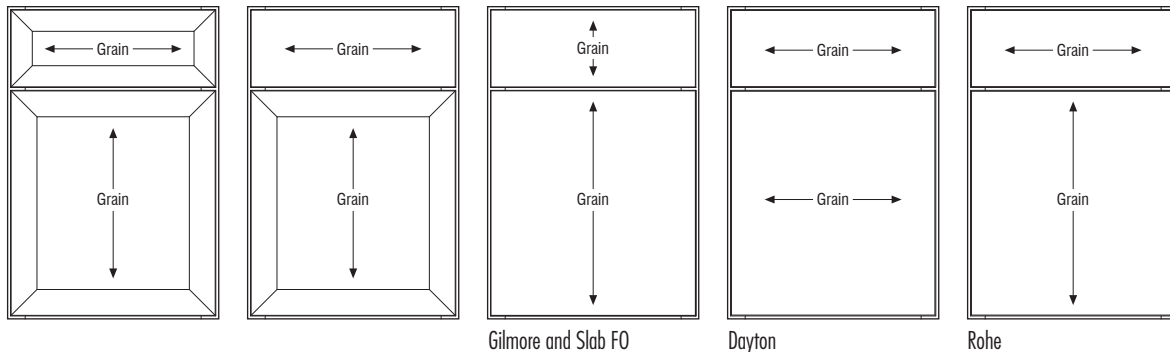

Gilmore and Slab FO

Dayton

Rohe

Wood Grain – Wall Top Hinge (WTH), Wall Vertical-lift (WVL), and Wall Appliance Garage Vertical-lift Door (WAGVLD) Cabinets

- Wall Top Hinge (WTH) Cabinets, 18"-24" Wide
- Wall Appliance Garage Vertical-lift Door (WAGVLD) Cabinets, 15"-24" Wide

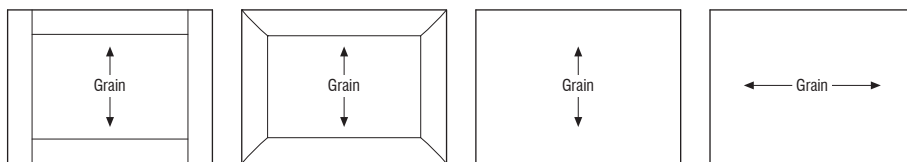

Non-mitered Door Styles

Mitered Door Styles

Gilmore, Rohe, and Slab FO

Dayton

- Wall Top Hinge (WTH) Cabinets, 30"-37" Wide
- Wall Vertical-lift (WVL) Cabinets, 30"-36" Wide

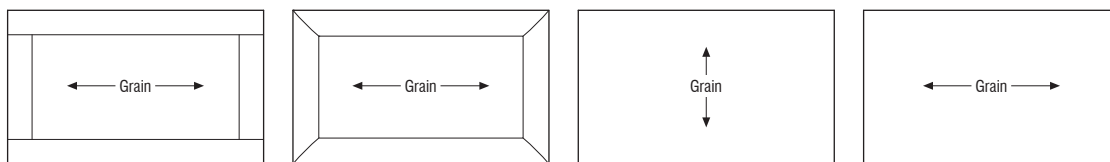

Non-mitered Door Styles

Mitered Door Styles

Gilmore and Slab FO

Dayton and Rohe

DOOR STYLES

Albany		Cherry	Maple	MDF	Oak	Rustic Alder	Rustic Hickory	PureStyle™	Specialty Laminate
	Price Point	—	—	—	—	—	—	—	7

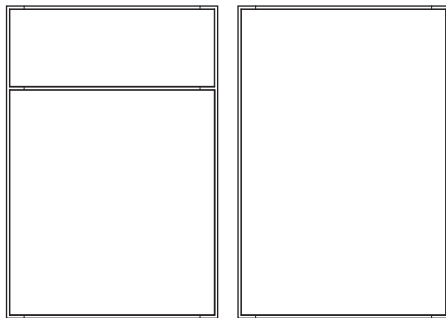

Base

Wall

Door Options

ALF	CG	DPSRR	MD	MFO	SHMD	PRMD
•	•	•	•	•	•	•

Custom Door and Drawer Front Options

DAPNL_/4	DAPNL_/4P	DADOORB	DADOORHG	DOORBL	DOORBR	DOORSLAB	DASPCDF	DASLBDF
•	•	•	•	•	•	•	•	•

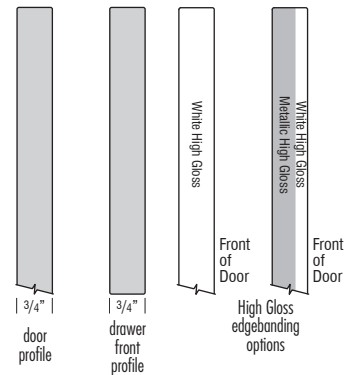

- Slab Door and Drawer Front
- Full Overlay
- Two Edgebanding Options

- Doors, drawer fronts, overlay fillers, and selected premium trim items will be in White High Gloss (see Trim section for availability of premium trim items). Backs of doors, drawer fronts, and Premium panels will be white laminate. All other cabinet components and embellishments will be Painted White.
- A heat shield is required to separate Albany doors, drawer fronts, overlay fillers, and all laminate products from heat producing units to be in compliance with cabinet warranty.

Special Notes:

- VWM_ cabinets are not available with this door style.
- If an Overlay Filler is required with this door style, order OL_P or OL_MFOP.

Berkley FO

	Cherry	Maple*	MDF	Oak	Rustic Alder	Rustic Hickory	PureStyle™	Specialty Laminate
Price Point	—	5	—	—	—	—	—	—

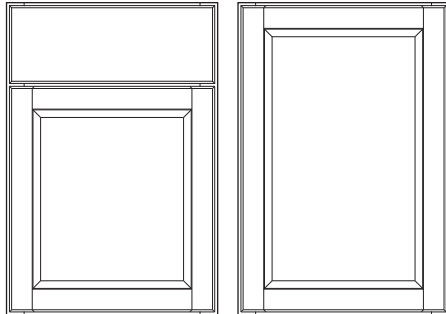

Base

Wall

Optional Drawer Front:

Flat 5-piece (DFF5PC and DFF5PCSLBT)

Door Options

ALF	CG	DPSRR	MD	MFO	SHMD	PRMD
•	•	•	•	•	•	•

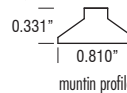

Custom Door and Drawer Front Options

DAPNL_/4	DAPNL_/4P	DADOORB	DADOORHG	DOORBL	DOORBR	DOORSLAB	DASPCDF	DASLBDF
•	•	•	•	•	•	•	•	•

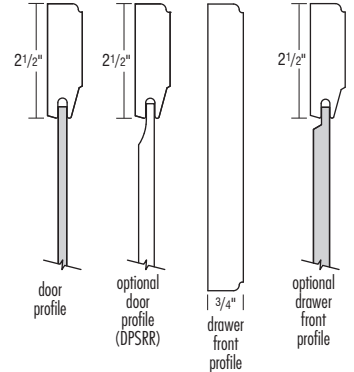

- Flat Center Panel
- Full Overlay
- Profiled Slab Drawer Front

- See chart to the right for 5-piece drawer front dimensions representative of a 9" wide base cabinet when specifying decorative hardware.

*When a Paint or Paint with Glaze finish is specified, the door and/or drawer front center panel may be constructed of Medium Density Fiberboard (MDF), except when Heirlooming is specified. MDF provides a smoother finish when painted, and is more resistant to warping, expansion, and contraction. Doors, drawer fronts, and additional facings may consist of other hardwood components.

5-piece Drawer Front Dimensions

Drawer Front Width	8 1/2"
Drawer Front Height	6 1/4"
Panel Flat Width	3 1/2"
Panel Flat Height	1 1/4"

DOOR STYLES

Berkley PO

	Cherry	Maple*	MDF	Oak	Rustic Alder	Rustic Hickory	PureStyle™	Specialty Laminate
Price Point	—	4	—	—	—	—	—	—

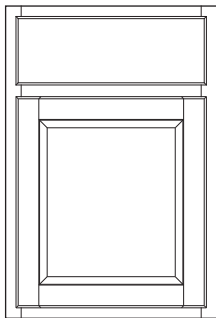

Base

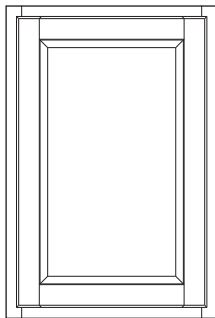

Wall

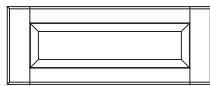

Optional Drawer Front:
Flat 5-piece (DFF5PC and DFF5PCSLBT)

Door Options

ALF	CG	DPSRR	MD	MFO	SHMD	PRMD
•	•	•	•	•	•	•

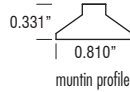

Custom Door and Drawer Front Options

DAPNL /4	DAPNL /4P	DADOORB	DADOORHG	DOORBL	DOORBR	DOORSLAB	DASPCDF	DASLBDF
•	•	•	•	•	•	•	•	•

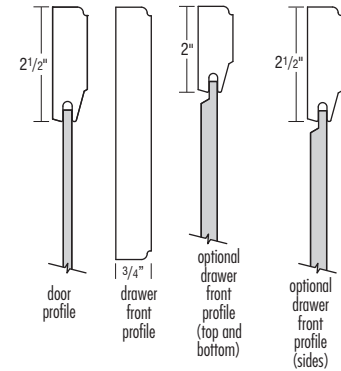

- Flat Center Panel
- Partial Overlay
- Profiled Slab Drawer Front

- See chart to the right for 5-piece drawer front dimensions representative of a 9" wide base cabinet when specifying decorative hardware.

*When a Paint or Paint with Glaze finish is specified, the door and/or drawer front center panel may be constructed of Medium Density Fiberboard (MDF), except when Heirlooming is specified. MDF provides a smoother finish when painted, and is more resistant to warping, expansion, and contraction. Doors, drawer fronts, and additional facings may consist of other hardwood components.

Special Notes:

- CH and CW modifications are not available with this door style.

5-piece Drawer Front Dimensions

Drawer Front Width	7"
Drawer Front Height	5 1/2"
Panel Flat Width	2"
Panel Flat Height	1 1/2"

Brawny FO

	Cherry	Maple*	MDF	Oak	Rustic Alder	Rustic Hickory	PureStyle™	Specialty Laminate
Price Point	7	5	5	4	7	7	—	—

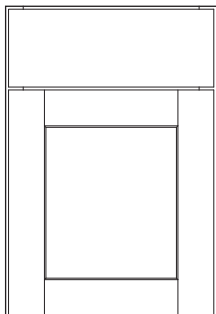

Base

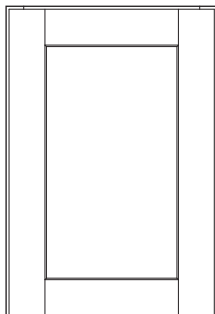

Wall

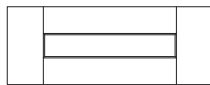

Optional Drawer Front:
Flat 5-piece (DFF5PC and DFF5PCSLBT)

Door Options

ALF	CG	DPSRR	MD	MFO	SHMD	PRMD
•	•	•	•	•	•	•

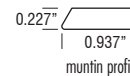

¹Not available on Brawny FO MDF.

Custom Door and Drawer Front Options

DAPNL /4	DAPNL /4P	DADOORB	DADOORHG	DOORBL	DOORBR	DOORSLAB	DASPCDF	DASLBDF
•	•	•	•	•	•	•	•	•

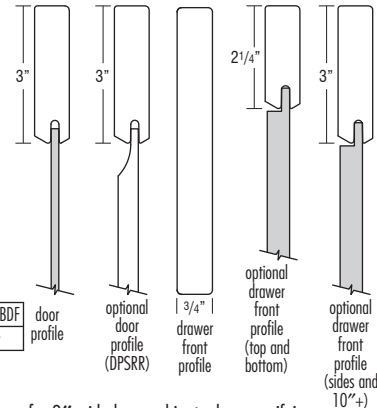

- Veneer** Flat Panel
- Full Overlay
- Slab Drawer Front

- See chart to the right for 5-piece drawer front dimensions representative of a 9" wide base cabinet when specifying decorative hardware.

*When a Paint or Paint with Glaze finish is specified, the door and/or drawer front center panel may be constructed of Medium Density Fiberboard (MDF), except when Heirlooming is specified. MDF provides a smoother finish when painted, and is more resistant to warping, expansion, and contraction. Doors, drawer fronts, and additional facings may consist of other hardwood components.

**When ordered in MDF, all door and drawer front components will be in MDF.

Special Notes:

- CH and CW modifications are not available with this door style in MDF.
- SCPDRW modifications are not available with this door style in MDF.
- SHMD doors in this door style will have "J" configuration for 15" and 30" wide cabinets and all DW cabinets.
- PRMD doors in this door style will have "L" configuration for 15" and 30" wide cabinets and all DW cabinets.
- OS3D_, OSB_, OCS_DD_, OCD_, OMC_, T3DMW_, and TMBWB_ cabinets (3" wide face frame versions) are not available with this door style in MDF.
- OL_ _MFO SKUs are not available with this door style in MDF.

5-piece Drawer Front Dimensions

Drawer Front Width	8 1/2"
Drawer Front Height	6 1/4"
Panel Flat Width	2 1/2"
Panel Flat Height	1 3/4"

F10

DOOR STYLES

DOOR STYLES

Celina

	Cherry	Maple*	MDF	Oak	Rustic Alder	Rustic Hickory	PureStyle™	Specialty Laminate
Price Point	11	10	—	—	—	—	—	—

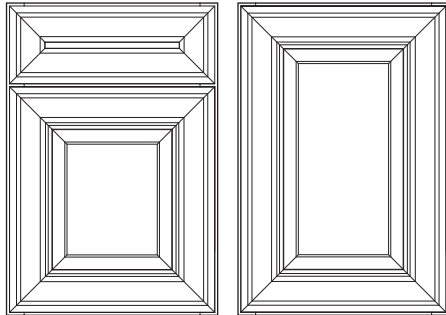

Base

Wall

Door Options

ALF	CG	DPSRR	MD	MFO	SHMD	PRMD
•	•	•	•	•	•	•

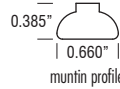

Custom Door and Drawer Front Options

DAPNL_/4	DAPNL_/4P	DADOORB	DADOORHG	DOORBL	DOORBR	DOORSLAB	DA5PCDF	DASLBDF
•	•	•	•	•	•	•	•	•

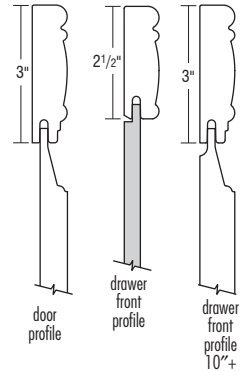

- Solid Raised Panel Mitered Door
- Full Overlay
- 5-piece Drawer Front Mitered to Match Door

- See chart to the right for 5-piece drawer front dimensions representative of a 9" wide base cabinet when specifying decorative hardware.

*When a Paint or Paint with Glaze finish is specified, the door and/or drawer front center panel may be constructed of Medium Density Fiberboard (MDF), except when Heirlooming is specified. MDF provides a smoother finish when painted, and is more resistant to warping, expansion, and contraction. Doors, drawer fronts, and additional facings may consist of other hardwood components.

Special Notes:

- CH and CW modifications are not available with this door style.

5-piece Drawer Front Dimensions

Drawer Front Width	8 1/2"
Drawer Front Height	6 1/4"
Panel Flat Width	3 1/2"
Panel Flat Height	1 1/4"

Danielson

	Cherry	Maple*	MDF	Oak	Rustic Alder	Rustic Hickory	PureStyle™	Specialty Laminate
Price Point	9	8	8	—	—	—	—	—

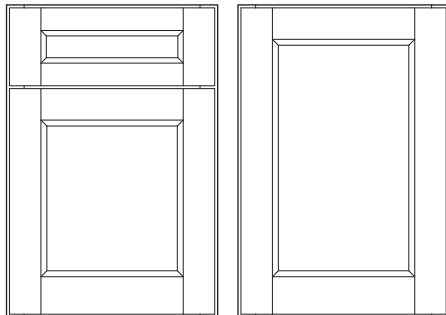

Base

Wall

Optional Drawer Front: Slab (DFSLB and DFSLBT)

Door Options

ALF	CG	DPSRR	MD	MFO	SHMD	PRMD
•	•	•	•	•	•	•

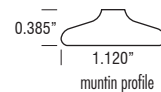

¹Not available on Danielson MDF.

Custom Door and Drawer Front Options

DAPNL_/4	DAPNL_/4P	DADOORB	DADOORHG	DOORBL	DOORBR	DOORSLAB	DA5PCDF	DASLBDF
•	•	•	•	•	•	•	•	•

¹Not available on Danielson MDF.

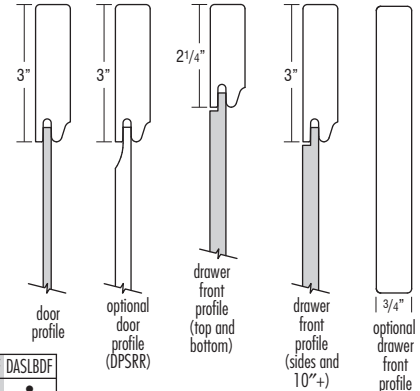

- Veneer** Flat Panel
- Full Overlay
- 5-piece Drawer Front

- See chart to the right for 5-piece drawer front dimensions representative of a 9" wide base cabinet when specifying decorative hardware.

*When a Paint finish is specified, the door and/or drawer front center panel may be constructed of Medium Density Fiberboard (MDF), except when Heirlooming is specified. MDF provides a smoother finish when painted, and is more resistant to warping, expansion, and contraction. Doors, drawer fronts, and additional facings may consist of other hardwood components.

**When ordered in MDF, all door and drawer front components will be in MDF.

Special Notes:

- CH and CW modifications are not available with this door style in MDF.
- SCPDRW modifications are not available with this door style in MDF.
- OS3D_, OSB_, OCS_DD, OCD_, OMC_, T3DMW_, and TMBWB_ cabinets (3" wide face frame versions) are not available with this door style in MDF.
- OL_ _MFO SKUs are not available with this door style in MDF.

5-piece Drawer Front Dimensions

Drawer Front Width	8 1/2"
Drawer Front Height	6 1/4"
Panel Flat Width	2 1/2"
Panel Flat Height	1 3/4"

F11

DOOR STYLES

DOOR STYLES

Dapper FO

	Cherry	Maple*	MDF	Oak	Rustic Alder	Rustic Hickory	PureStyle™	Specialty Laminate
Price Point	7	5	—	4	—	7	—	—

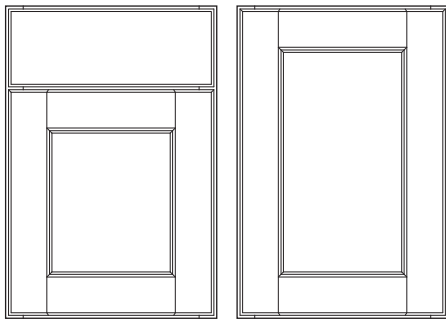

Base Wall

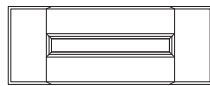

Optional Drawer Front:
Flat 5-piece (DFF5PC and DFF5PCSLBT)

Door Options

ALF	CG	DPSRR	MD	MFO	SHMD	PRMD
•	•	•	•	•	•	•

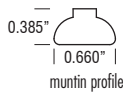

Custom Door and Drawer Front Options

DAPNL_ /4	DAPNL_ /4P	DADOORB	DADOORHG	DOORB	DOORBR	DOORSLAB	DASPCDF	DASLDBF
•	•	•	•	•	•	•	•	•

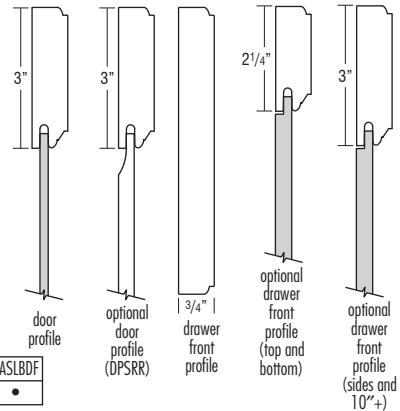

- Veneer Flat Panel
- Full Overlay
- Profiled Slab Drawer Front

- See chart to the right for 5-piece drawer front dimensions representative of a 9" wide base cabinet when specifying decorative hardware.

*When a Paint or Paint with Glaze finish is specified, the door and/or drawer front center panel may be constructed of Medium Density Fiberboard (MDF), except when Heirlooming is specified. MDF provides a smoother finish when painted, and is more resistant to warping, expansion, and contraction. Doors, drawer fronts, and additional facings may consist of other hardwood components.

5-piece Drawer Front Dimensions

Drawer Front Width	8 1/2"
Drawer Front Height	6 1/4"
Panel Flat Width	2 1/2"
Panel Flat Height	1 3/4"

F12

DOOR STYLES

Dayton

	Cherry	Maple	MDF	Oak	Rustic Alder	Rustic Hickory	PureStyle™	Specialty Laminate
Price Point	—	—	—	—	—	—	—	7

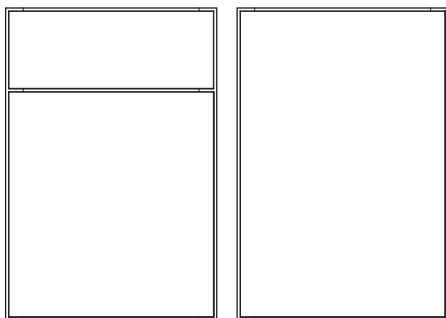

Base Wall

Door Options

ALF	CG	DPSRR	MD	MFO	SHMD	PRMD
•	•	•	•	•	•	•

Custom Door and Drawer Front Options

DAPNL_ /4	DAPNL_ /4P	DAPNL_ /4HG	DADOORB	DADOORHG	DOORB	DOORBR	DOORSLAB	DASPCDF	DASLDBF
•	•	•	•	•	•	•	•	•	•

Finishes Cabinet Box Color Options

	Icy				
	Black	Cloud	Avalanche	Storm	White
Arctic	•	•	•	•	•
Obsidian	•	•	•	•	•

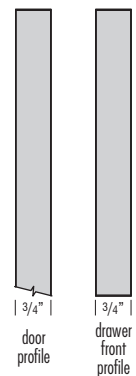

- Laminate Slab Door and Drawer Front with Matching Edgebanding
- Arctic and Obsidian feature a textured surface.
- Horizontal Grain Pattern for Contemporary Styling
- Full Overlay
- Doors, drawer fronts, overlay fillers, and selected premium trim items will be in the selected laminate. All other cabinet components and trim items will be in the selected cabinet box color.

- Doors and overlay fillers greater than 48" high will be two pieces. Doors will be doweled together with zinc connector pins and black plastic spacers. Replacement doors will be drilled and doweled but require field assembly.
- A heat shield is required to separate Dayton doors, drawer fronts, overlay fillers, and all textured laminate products from heat producing units to be in compliance with cabinet warranty.
- Storm box color will have visible vertical grain matching end panels.

Special Notes:

- VWM_ cabinets are not available with this door style.
- On tall cabinets, horizontal grain doors greater than 48" high will be two doors doweled together.
- When a panel is required, order Horizontal Grain Premium models 14PANEL_P and 34PANEL_P.
- If an Overlay Filler is required with this door style, order OL_P or OL_MFOP. Premium, horizontal grain, overlay fillers greater than 48" high will be comprised of two segments and require field assembly (allow 3/16" gap between overlays for alignment with adjacent doors).

DOOR STYLES

Detailed FO

	Cherry	Maple*	MDF	Oak	Rustic Alder	Rustic Hickory	PureStyle™	Specialty Laminate
Price Point	7	5	—	—	—	—	—	—

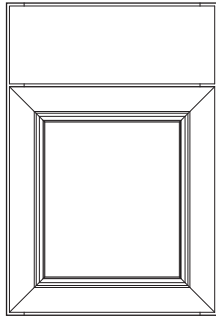

Base

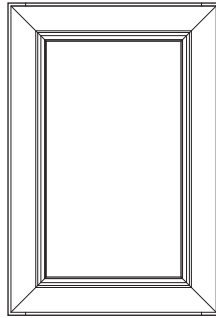

Wall

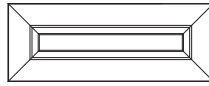

Optional Drawer Front:
Flat 5-piece (DFF5PC and DFF5PCSLBT)

Door Options

ALF	CG	DPSRR	MD	MFO	SHMD	PRMD
•	•	•	•	•	•	•

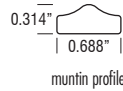

Custom Door and Drawer Front Options

DAPNL_ /4	DAPNL_ /4P	DADOORB	DADOORHG	DOORBL	DOORBR	DOORSLAB	DA5PCDF	DASLBDF
•	•	•	•	•	•	•	•	•

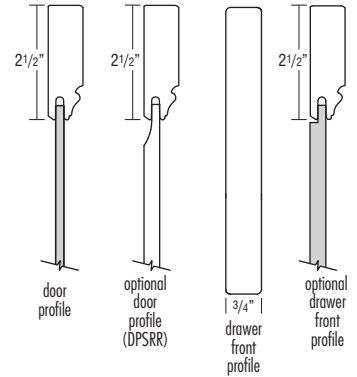

- Veneer Flat Panel Mitered Door
- Full Overlay
- Slab Drawer Front

- See chart to the right for 5-piece drawer front dimensions representative of a 9" wide base cabinet when specifying decorative hardware.

*When a Paint or Paint with Glaze finish is specified, the door and/or drawer front center panel may be constructed of Medium Density Fiberboard (MDF), except when Heirlooming is specified. MDF provides a smoother finish when painted, and is more resistant to warping, expansion, and contraction. Doors, drawer fronts, and additional facings may consist of other hardwood components.

Special Notes:

- CH and CW modifications are not available with this door style.
- Silhouette glass is not recommended for use with this door style.

5-piece Drawer Front Dimensions

Drawer Front Width	8 1/2"
Drawer Front Height	6 1/4"
Panel Flat Width	3 1/2"
Panel Flat Height	1 1/4"

Detailed PO

	Cherry	Maple*	MDF	Oak	Rustic Alder	Rustic Hickory	PureStyle™	Specialty Laminate
Price Point	6	4	—	—	—	—	—	—

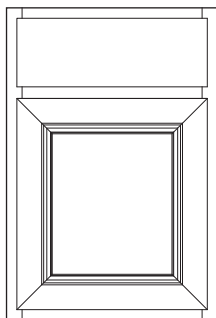

Base

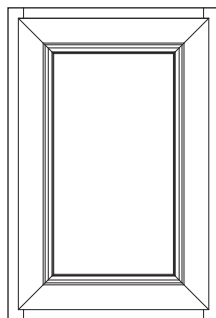

Wall

Door Options

ALF	CG	DPSRR	MD	MFO	SHMD	PRMD
•	•	•	•	•	•	•

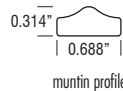

Custom Door and Drawer Front Options

DAPNL_ /4	DAPNL_ /4P	DADOORB	DADOORHG	DOORBL	DOORBR	DOORSLAB	DA5PCDF	DASLBDF
•	•	•	•	•	•	•	•	•

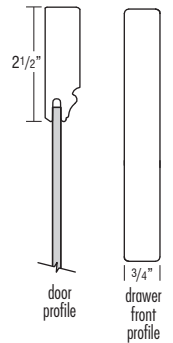

- Veneer Flat Panel Mitered Door
- Partial Overlay
- Slab Drawer Front

*When a Paint or Paint with Glaze finish is specified, the door center panel may be constructed of Medium Density Fiberboard (MDF), except when Heirlooming is specified. MDF provides a smoother finish when painted, and is more resistant to warping, expansion, and contraction. Doors, drawer fronts, and additional facings may consist of other hardwood components.

Special Notes:

- CH and CW modifications are not available with this door style.
- Silhouette glass is not recommended for use with this door style.

DOOR STYLES

Garland

	Cherry	Maple*	MDF	Oak	Rustic Alder	Rustic Hickory	PureStyle™	Specialty Laminate
Price Point	10	9	—	—	—	—	—	—

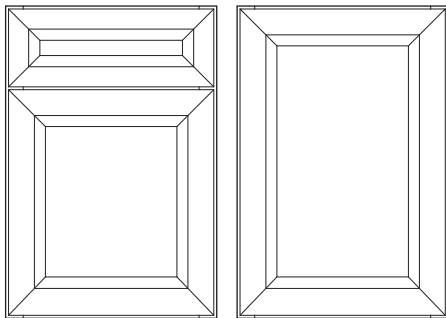

Base Wall



Optional Drawer Front:
Slab (DFSLB and DFSLBT)

Door Options

ALF	CG	DPSRR	MD	MFO	SHMD	PRMD
•	•	•	•	•	•	•

Custom Door and Drawer Front Options

DAPNL_ /4	DAPNL_ /4P	DADOORB	DADOORHG	DOORBL	DOORBR	DOORSLAB	DASPCDF	DASLBDF
•	•	•	•	•	•	•	•	•

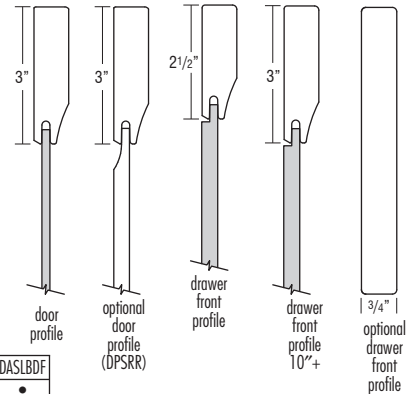

- Veneer Flat Panel Mitered Door
- Full Overlay
- 5-piece Drawer Front Mitered to Match Door

- See chart to the right for 5-piece drawer front dimensions representative of a 9" wide base cabinet when specifying decorative hardware.

*When a Paint or Paint with Glaze finish is specified, the door and/or drawer front center panel may be constructed of Medium Density Fiberboard (MDF), except when Heirlooming is specified. MDF provides a smoother finish when painted, and is more resistant to warping, expansion, and contraction. Doors, drawer fronts, and additional facings may consist of other hardwood components.

5-piece Drawer Front Dimensions

Drawer Front Width	8 1/2"
Drawer Front Height	6 1/4"
Panel Flat Width	3 1/2"
Panel Flat Height	1 1/4"

Special Notes:

- CH and CW modifications are not available with this door style.

Gilmore

	Cherry	Maple	MDF	Oak	Rustic Alder	Rustic Hickory	PureStyle™	Specialty Laminate
Price Point	—	—	—	—	—	—	—	7

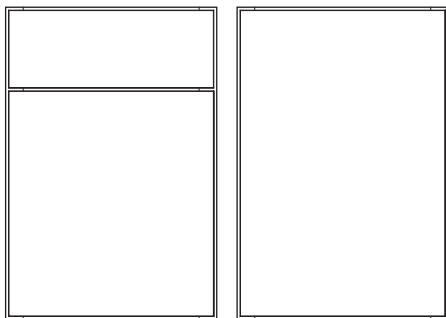

Base Wall

Door Options

ALF	CG	DPSRR	MD	MFO	SHMD	PRMD
•	•	•	•	•	•	•

Custom Door and Drawer Front Options

DAPNL_ /4	DAPNL_ /4P	DADOORB	DADOORHG	DOORBL	DOORBR	DOORSLAB	DASPCDF	DASLBDF
•	•	•	•	•	•	•	•	•

Finishes

Cabinet Box Color Options

	Boardwalk	Chocolate	Cloud	Avalanche	Morel	Seal	Thatch	White
Antler	•		•		•			•
Elk	•					•	•	
Gunstock		•					•	
Icy Avalanche Linea Nightfall				•				
Wharf								•

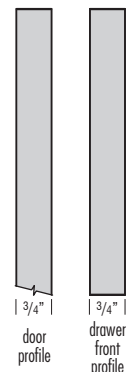

- Laminate Slab Door and Drawer Front with Matching Edgebanding
- Elk, Gunstock, and Wharf feature a textured surface. Antler and Icy Avalanche Linea Nightfall are non-textured.
- Vertical Grain Pattern
- Full Overlay

- Doors, drawer fronts, overlay fillers, and selected premium trim items will be in the selected laminate. All other cabinet components and trim items will be in the selected cabinet box color.
- A heat shield is required to separate Gilmore doors, drawer fronts, overlay fillers, and all laminate products from heat producing units to be in compliance with cabinet warranty.
- Wood Tone Stain box colors will have visible vertical grain matching end panels.

Special Notes:

- VWM_ cabinets are not available with this door style.
- If an Overlay Filler is required with this door style, order OL_P or OL_MFOP.
- DASLBDF grain direction is vertical on this door style.

F14

DOOR STYLES

DOOR STYLES

Glyndon

	Cherry	Maple*	MDF	Oak	Rustic Alder	Rustic Hickory	PureStyle™	Specialty Laminate
Price Point	5	3	—	—	5	—	—	—

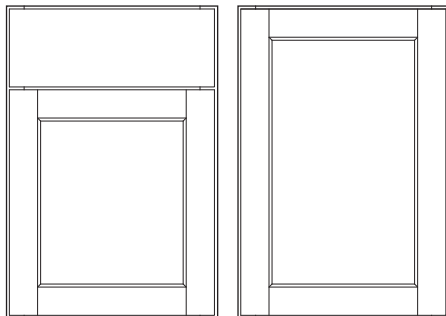

Base

Wall

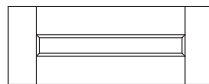

Optional Drawer Front:
Flat 5-piece (DFF5PC and DFF5PCSLBT)

Door Options

ALF	CG	DPSRR	MD	MFO	SHMD	PRMD
•	•	•	•	•	•	•

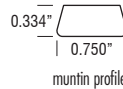

Custom Door and Drawer Front Options

DAPNL /4	DAPNL /4P	DADOORB	DADOORHG	DOORBL	DOORBR	DOORSLAB	DA5PCDF	DASLBDF
•	•	•	•	•	•	•	•	•

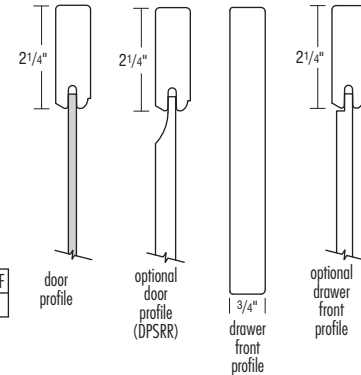

- Veneer Flat Panel
- Full Overlay
- Slab Drawer Front

- See chart to the right for 5-piece drawer front dimensions representative of a 9" wide base cabinet when specifying decorative hardware.

*When a Paint or Paint with Glaze finish is specified, the door and/or drawer front center panel may be constructed of Medium Density Fiberboard (MDF), except when Heirlooming is specified. MDF provides a smoother finish when painted, and is more resistant to warping, expansion, and contraction. Doors, drawer fronts, and additional facings may consist of other hardwood components.

5-piece Drawer Front Dimensions

Drawer Front Width	8 1/2"
Drawer Front Height	6 1/4"
Panel Flat Width	4"
Panel Flat Height	1 3/4"

Healy

	Cherry	Maple*	MDF	Oak	Rustic Alder	Rustic Hickory	PureStyle™	Specialty Laminate
Price Point	12	11	—	—	—	12	—	—

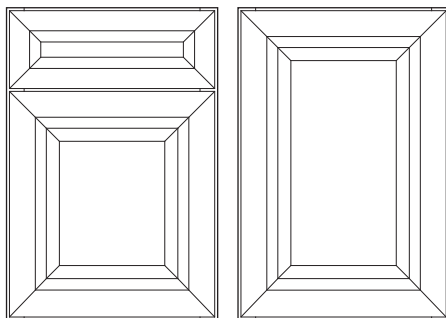

Base

Wall



Optional Drawer Front:
Slab (DFSLB and DFSLBT)

Door Options

ALF	CG	DPSRR	MD	MFO	SHMD	PRMD
•	•	•	•	•	•	•

Custom Door and Drawer Front Options

DAPNL /4	DAPNL /4P	DADOORB	DADOORHG	DOORBL	DOORBR	DOORSLAB	DA5PCDF	DASLBDF
•	•	•	•	•	•	•	•	•

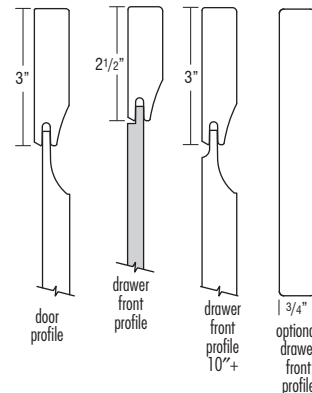

- Solid Raised Panel Mitered Door
- Full Overlay
- 5-piece Drawer Front Mitered to Match Door

- See chart to the right for 5-piece drawer front dimensions representative of a 9" wide base cabinet when specifying decorative hardware.

*When a Paint or Paint with Glaze finish is specified, the door and/or drawer front center panel may be constructed of Medium Density Fiberboard (MDF), except when Heirlooming is specified. MDF provides a smoother finish when painted, and is more resistant to warping, expansion, and contraction. Doors, drawer fronts, and additional facings may consist of other hardwood components.

Special Notes:

- CH and CW modifications are not available with this door style.

5-piece Drawer Front Dimensions

Drawer Front Width	8 1/2"
Drawer Front Height	6 1/4"
Panel Flat Width	3 1/2"
Panel Flat Height	1 1/4"

DOOR STYLES

Henning

	Cherry	Maple	MDF	Oak	Rustic Alder	Rustic Hickory	PureStyle™	Specialty Laminate
Price Point	—	—	—	—	—	—	9	—

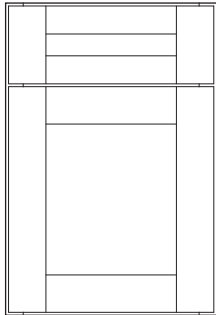

Base

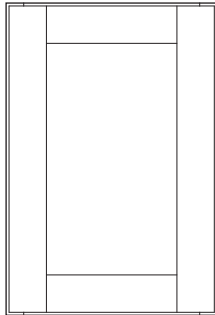

Wall

Door Options

ALF	CG	DPSRR	MD	MFO	SHMD	PRMD
•						

Custom Door and Drawer Front Options

DAPNL_/4	DAPNL_/4P	DADOORB	DADOORHG	DOORBL	DOORBR	DOORSLAB	DASPCDF	DASLBDF
•	•							

Finishes

Cabinet Box Color Options

	Boardwalk	Chocolate	Icy Avalanche	Seal	Thatch
Elk	•			•	•
Gunstock		•			•
Icy Avalanche Linea Nightfall			•		

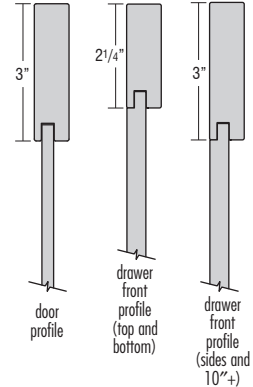

- Laminate Wrapped MDF Door and Drawer Rails
- Full Overlay
- 5-piece Drawer Front
- Doors, drawer fronts, overlay fillers, and selected premium trim items will be in the selected laminate. All other cabinet components and embellishments will be in selected cabinet box color and species.

- A heat shield is required to separate Henning doors, drawer fronts, overlay fillers, and all laminate products from heat producing units to be in compliance with cabinet warranty.
- See chart to the right for 5-piece drawer front dimensions representative of a 9" wide base cabinet when specifying decorative hardware.
- Wood Tone Stain box colors will have visible vertical grain matching end panels.

Special Notes:

- CH and CW modifications are not available with this door style.
- SCPDRW modifications are not available with this door style.
- PWT_ cabinets are not available with this door style.
- OS3D_, OSB_, OCS_DD, OCD_, OMC_, T3DMW_, and TMBWB_ cabinets (3" wide face frame versions) are not available with this door style.
- VWM_ cabinets are not available with this door style.
- OL_ _MFO SKUs are not available with this door style.
- If an Overlay Filler is required with this door style, order OL_P.

5-piece Drawer Front Dimensions

Drawer Front Width	8 1/2"
Drawer Front Height	6 1/4"
Panel Flat Width	2 1/2"
Panel Flat Height	1 3/4"

Henri

	Cherry	Maple*	MDF	Oak	Rustic Alder	Rustic Hickory	PureStyle™	Specialty Laminate
Price Point	5	3	—	—	—	—	—	—

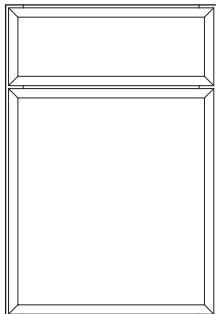

Base

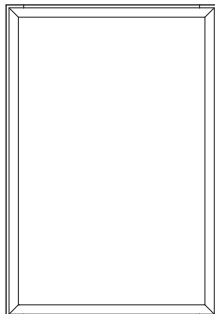

Wall

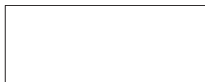

Optional Drawer Front:
Slab (DFSLB and DFSLBT)

Door Options

ALF	CG	DPSRR	MD	MFO	SHMD	PRMD
•						

Custom Door and Drawer Front Options

DAPNL_/4	DAPNL_/4P	DADOORB	DADOORHG	DOORBL	DOORBR	DOORSLAB	DASPCDF	DASLBDF
•	•	•	•	•	•	•	•	•

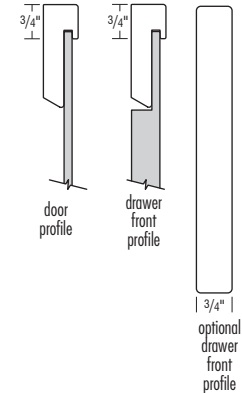

- Veneer Flat Panel Mitered Door
- Full Overlay
- 5-piece Drawer Front Mitered to Match Door

- See chart to the right for 5-piece drawer front dimensions representative of a 9" wide base cabinet when specifying decorative hardware.
- *When a Paint or Paint with Glaze finish is specified, the door and/or drawer front center panel may be constructed of Medium Density Fiberboard (MDF), except when Heirlooming is specified. MDF provides a smoother finish when painted, and is more resistant to warping, expansion, and contraction. Doors, drawer fronts, and additional facings may consist of other hardwood components.

Special Notes:

- CH and CW modifications are not available with this door style.
- If 3CDB36 cabinet is ordered in this door style, drawer fronts on that cabinet will always be slab even if other options are selected.

5-piece Drawer Front Dimensions

Drawer Front Width	8 1/2"
Drawer Front Height	6 1/4"
Panel Flat Width	7"
Panel Flat Height	4 3/4"

F16

DOOR STYLES

DOOR STYLES

Jasper

	Cherry	Maple*	MDF	Oak	Rustic Alder	Rustic Hickory	PureStyle™	Specialty Laminate
Price Point	9	8	—	—	—	—	—	—

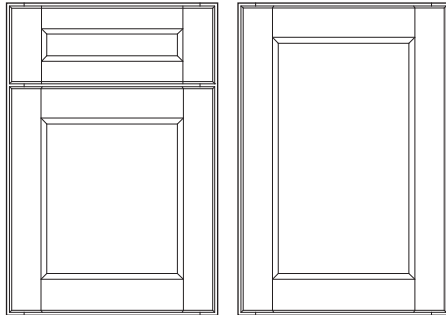

Base

Wall



Optional Drawer Front Slab (DFSLB and DFSLBT)

Door Options

ALF	CG	DPSRR	MD	MFO	SHMD	PRMD
•	•	•	•	•	•	•

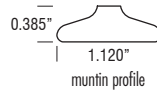

muntin profile

Custom Door and Drawer Front Options

DAPNL_/4	DAPNL_/4P	DADOORB	DADOORHG	DOORBL	DOORBR	DOORSLAB	DASPCDF	DASLBDF
•	•	•	•	•	•	•	•	•

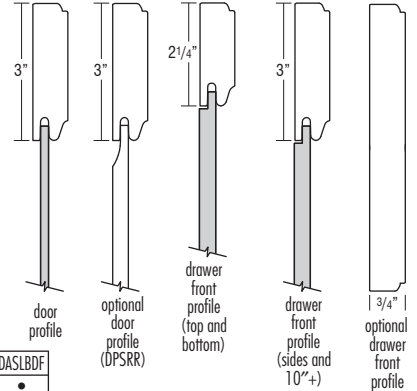

- Veneer Flat Panel
- Full Overlay
- 5-piece Drawer Front

- See chart to the right for 5-piece drawer front dimensions representative of a 9" wide base cabinet when specifying decorative hardware.

*When a Paint finish is specified, the door and/or drawer front center panel may be constructed of Medium Density Fiberboard (MDF), except when Heirlooming is specified. MDF provides a smoother finish when painted, and is more resistant to warping, expansion, and contraction. Doors, drawer fronts, and additional facings may consist of other hardwood components.

5-piece Drawer Front Dimensions

Drawer Front Width	8 1/2"
Drawer Front Height	6 1/4"
Panel Flat Width	2 1/2"
Panel Flat Height	1 3/4"

Paquette

	Cherry	Maple*	MDF	Oak	Rustic Alder	Rustic Hickory	PureStyle™	Specialty Laminate
Price Point	11	10	—	—	—	—	—	—

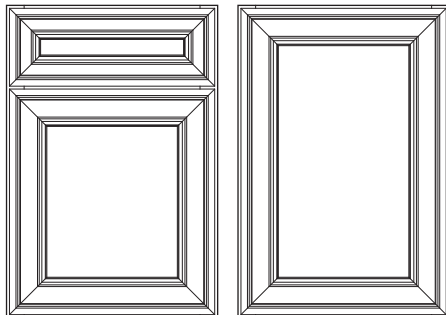

Base

Wall

Door Options

ALF	CG	DPSRR	MD	MFO	SHMD	PRMD
•	•	•	•	•	•	•

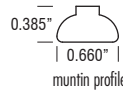

muntin profile

Custom Door and Drawer Front Options

DAPNL_/4	DAPNL_/4P	DADOORB	DADOORHG	DOORBL	DOORBR	DOORSLAB	DASPCDF	DASLBDF
•	•	•	•	•	•	•	•	•

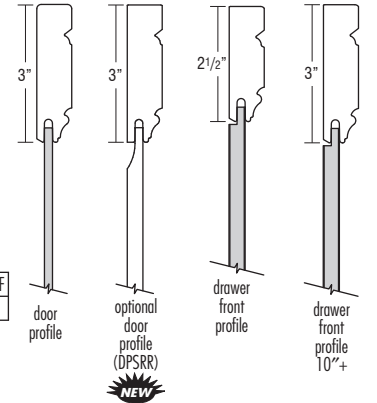

- Veneer Flat Panel Mitered Door
- Full Overlay
- 5-piece Drawer Front Mitered to Match Door
- Faux Inset Design

- See chart to the right for 5-piece drawer front dimensions representative of a 9" wide base cabinet when specifying decorative hardware.

*When a Paint or Paint with Glaze finish is specified, the door and/or drawer front center panel may be constructed of Medium Density Fiberboard (MDF), except when Heirlooming is specified. MDF provides a smoother finish when painted, and is more resistant to warping, expansion, and contraction. Doors, drawer fronts, and additional facings may consist of other hardwood components.

Special Notes:

- CH and CW modifications are not available with this door style.

5-piece Drawer Front Dimensions

Drawer Front Width	8 1/2"
Drawer Front Height	6 1/4"
Panel Flat Width	3 1/2"
Panel Flat Height	1 1/4"

DOOR STYLES

Payson

	Cherry	Maple*	MDF	Oak	Rustic Alder	Rustic Hickory	PureStyle™	Specialty Laminate
Price Point	8	6	—	5	8	8	—	—

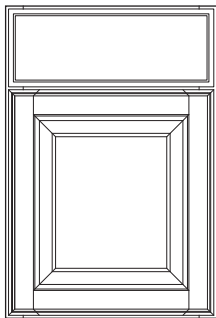

Base

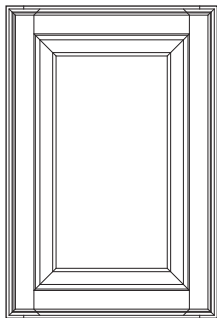

Wall

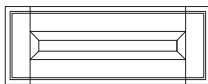

Optional Drawer Front:
Flat 5-piece (DFF5PC and DFF5PCSLBT)

Door Options

ALF	CG	DPSRR	MD	MFO	SHMD	PRMD
•	•	•	•	•	•	•

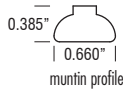

0.385" | 0.660" |
muntin profile

Custom Door and Drawer Front Options

DAPNL /4	DAPNL /4P	DADOORB	DADOORHG	DOORBL	DOORBR	DOORSLAB	DA5PCDF	DASLBDF
•	•	•	•	•	•	•	•	•



- Solid Raised Panel
- Full Overlay
- Profiled Slab Drawer Front

- See chart to the right for 5-piece drawer front dimensions representative of a 9" wide base cabinet when specifying decorative hardware.

*When a Paint or Paint with Glaze finish is specified, the door and/or drawer front center panel may be constructed of Medium Density Fiberboard (MDF), except when Heirlooming is specified. MDF provides a smoother finish when painted, and is more resistant to warping, expansion, and contraction. Doors, drawer fronts, and additional facings may consist of other hardwood components.

Special Notes:

- Silhouette glass is not recommended for use with this door style.

5-piece Drawer Front Dimensions

Drawer Front Width	8 1/2"
Drawer Front Height	6 1/4"
Panel Flat Width	3 1/2"
Panel Flat Height	1 1/4"

F18

DOOR STYLES

Perry FO

	Cherry	Maple*	MDF	Oak	Rustic Alder	Rustic Hickory	PureStyle™	Specialty Laminate
Price Point	7	5	—	—	—	—	—	—

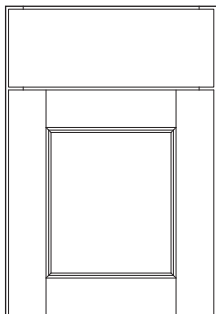

Base

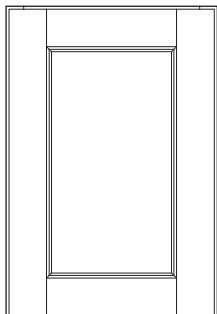

Wall

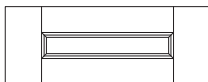

Optional Drawer Front:
Flat 5-piece (DFF5PC and DFF5PCSLBT)

Door Options

ALF	CG	DPSRR	MD	MFO	SHMD	PRMD
•	•	•	•	•	•	•

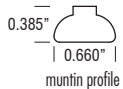

0.385" | 0.660" |
muntin profile

Custom Door and Drawer Front Options

DAPNL /4	DAPNL /4P	DADOORB	DADOORHG	DOORBL	DOORBR	DOORSLAB	DA5PCDF	DASLBDF
•	•	•	•	•	•	•	•	•

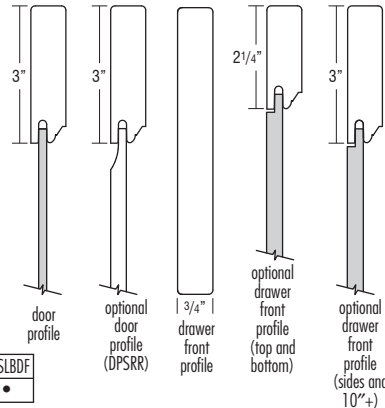

- Veneer Flat Panel
- Full Overlay
- Slab Drawer Front

- See chart to the right for 5-piece drawer front dimensions representative of a 9" wide base cabinet when specifying decorative hardware.

*When a Paint or Paint with Glaze finish is specified, the door and/or drawer front center panel may be constructed of Medium Density Fiberboard (MDF), except when Heirlooming is specified. MDF provides a smoother finish when painted, and is more resistant to warping, expansion, and contraction. Doors, drawer fronts, and additional facings may consist of other hardwood components.

5-piece Drawer Front Dimensions

Drawer Front Width	8 1/2"
Drawer Front Height	6 1/4"
Panel Flat Width	2 1/2"
Panel Flat Height	1 3/4"

DOOR STYLES

Rohe

	Cherry	Maple	MDF	Oak	Rustic Alder	Rustic Hickory	PureStyle™	Specialty Laminate
Price Point	10	9	—	—	—	—	—	—

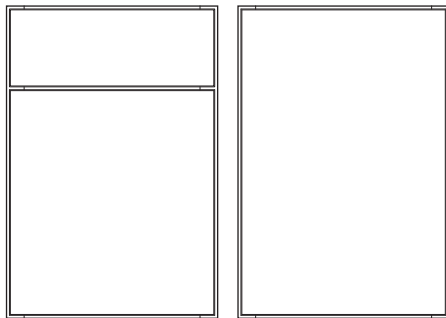

Base

Wall

Door Options

ALF	CG	DPSRR	MD	MFO	SHMD	PRMD
•						

Custom Door and Drawer Front Options

DAPNL_ /4	DAPNL_ /4P	DADOORB	DADOORHG	DOORBL	DOORBR	DOORSLAB	DA5PCDF	DASLBDF
•								

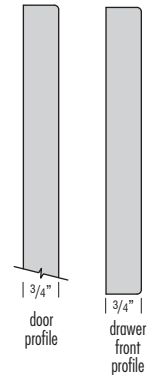

- Slab Door and Drawer Front
- Veneer Face and Back
- Wood Edging on All Edges

- Furniture Board Core
- Full Overlay
- Grain direction is vertical on doors and horizontal on drawer fronts.

Special Notes:

- CH and CW modifications are not available with this door style.
- PWT_ cabinets are not available with this door style.
- VWM_ cabinets are not available with this door style.
- OL_ _ MFO SKUs are not available with this door style.

Sanford

	Cherry	Maple*	MDF	Oak	Rustic Alder	Rustic Hickory	PureStyle™	Specialty Laminate
Price Point	9	7	—	—	—	—	—	—

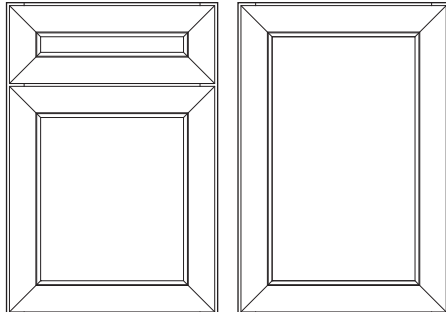

Base

Wall

Optional Drawer Front:
Slab (DFSLB and DFSLBT)

Door Options

ALF	CG	DPSRR	MD	MFO	SHMD	PRMD
•	•	•	•	•	•	•

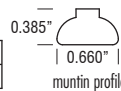

Custom Door and Drawer Front Options

DAPNL_ /4	DAPNL_ /4P	DADOORB	DADOORHG	DOORBL	DOORBR	DOORSLAB	DA5PCDF	DASLBDF
•								

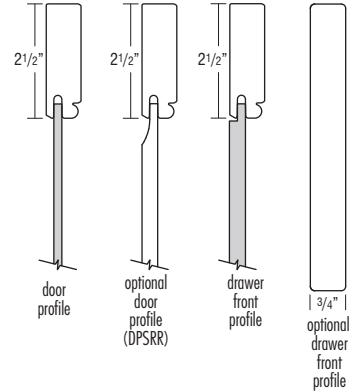

- Veneer Flat Panel Mitered Door
- Full Overlay
- 5-piece Drawer Front Mitered to Match Door

- See chart to the right for 5-piece drawer front dimensions representative of a 9" wide base cabinet when specifying decorative hardware.

*When a Paint or Paint with Glaze finish is specified, the door and/or drawer front center panel may be constructed of Medium Density Fiberboard (MDF), except when Heirlooming is specified. MDF provides a smoother finish when painted, and is more resistant to warping, expansion, and contraction. Doors, drawer fronts, and additional facings may consist of other hardwood components.

Special Notes:

- CH and CW modifications are not available with this door style.
- Silhouette glass is not recommended for use with this door style.

5-piece Drawer Front Dimensions

Drawer Front Width	8 1/2"
Drawer Front Height	6 1/4"
Panel Flat Width	3 1/2"
Panel Flat Height	1 1/4"

F19

DOOR STYLES

DOOR STYLES

Simple FO

	Cherry	Maple*	MDF	Oak	Rustic Alder	Rustic Hickory	PureStyle™	Specialty Laminate
Price Point	5	3	3	2	5	5	—	—

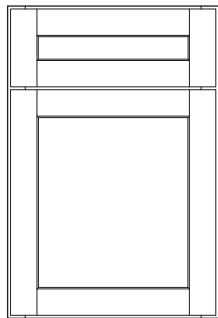

Base

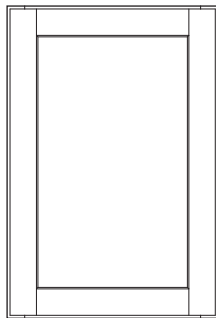

Wall



Optional Drawer Front: Slab (DFS LB and DFS LBT)



Optional Drawer Front: Flat 5-piece Narrow Rails (DFF5PCNR and DFF5PCNRST)***

Door Options

ALF	CG	DPSRR	MD	MFO	SHMD	PRMD
•	•	•	•	•	•	•

¹ Not available on Simple FO MDF.

Custom Door and Drawer Front Options

DAPNL	/4	DAPNL	/4P	DADOORB	DADOORHG	DOORBL	DOORBR	DOORSLAB	DA5PCDF	DASLBDF
•	•	•	•	•	•	•	•	•	•	•

¹ Not available on Simple FO MDF.

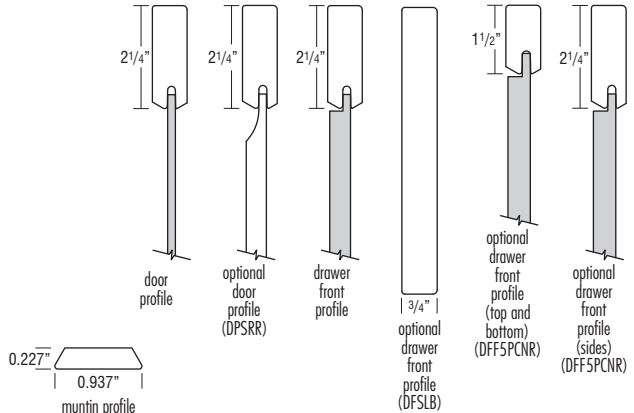

F20

DOOR STYLES

- Veneer** Flat Panel
- Full Overlay
- 5-piece Drawer Front

- See chart to the right for 5-piece drawer front dimensions representative of a 9" wide base cabinet when specifying decorative hardware.
- *When a Paint or Paint with Glaze finish is specified, the door and/or drawer front center panel may be constructed of Medium Density Fiberboard (MDF), except when Heirlooming is specified. MDF provides a smoother finish when painted, and is more resistant to warping, expansion, and contraction. Doors, drawer fronts, and additional facings may consist of other hardwood components.
- **When ordered in MDF, all door and drawer front components will be in MDF.
- ***DFF5PCNR not available in Oak. DFF5PCNR drawer front center panel grain direction is vertical.

Special Notes:

- CH and CW modifications are not available with this door style in MDF.
- SCPDRW modifications are not available with this door style in MDF.
- OS3D_, OSB_, OCS_DD, OCD_, OMC_, T3DMW_, and TMBWB_ cabinets (3" wide face frame versions) are not available with this door style in MDF.
- OL_ _MFO SKUs are not available in this door style in MDF.
- DA5PCDF grain direction is vertical on this door style when used with DFF5PCNR.

5-piece Drawer Front Dimensions

	DFF5PC	DFF5PCNR
Drawer Front Width	8 1/2"	8 1/2"
Drawer Front Height	6 1/4"	6 1/4"
Panel Flat Width	4"	4"
Panel Flat Height	1 3/4"	3 1/4"

DOOR STYLES

Simple PO

	Cherry	Maple*	MDF	Oak	Rustic Alder	Rustic Hickory	PureStyle™	Specialty Laminate
Price Point	—	2	—	1	4	4	—	—

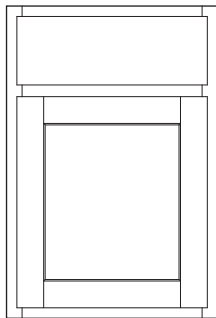

Base

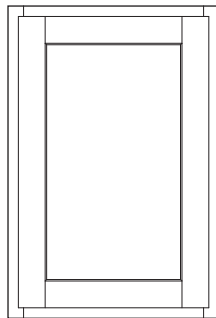

Wall

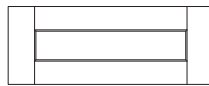

Optional Drawer Front:
Flat 5-piece (DFF5PC and DFF5PCSLBT)

Door Options

ALF	CG	DPSRR	MD	MFO	SHMD	PRMD
•			•			

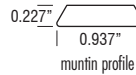

Custom Door and Drawer Front Options

DAPNL_/4	DAPNL_/4P	DADOORB	DADOORHG	DOORBL	DOORBR	DOORSLAB	DA5PCDF	DASLBDF
•							•	•

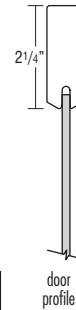

door profile



3/4" drawer front profile



optional drawer front profile (top and bottom)

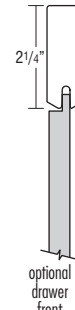

optional drawer front profile (sides)

- Veneer Flat Panel
- Partial Overlay
- Slab Drawer Front

- See chart to the right for 5-piece drawer front dimensions representative of a 9" wide base cabinet when specifying decorative hardware.

*When a Paint or Paint with Glaze finish is specified, the door center panel may be constructed of Medium Density Fiberboard (MDF), except when Heirlooming is specified. MDF provides a smoother finish when painted, and is more resistant to warping, expansion, and contraction. Doors, drawer fronts, and additional facings may consist of other hardwood components.

Special Notes:

- CH and CW modifications are not available with this door style.

5-piece Drawer Front Dimensions

Drawer Front Width	7"
Drawer Front Height	5 1/2"
Panel Flat Width	2 1/2"
Panel Flat Height	1 1/2"

Slab FO

	Cherry	Maple	MDF	Oak	Rustic Alder	Rustic Hickory	PureStyle™	Specialty Laminate
Price Point	5	3	3	—	—	—	—	—

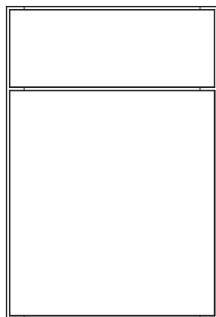

Base

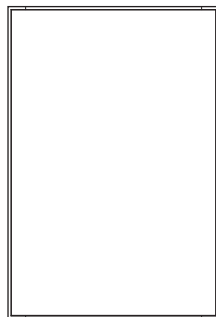

Wall

Door Options

ALF	CG	DPSRR	MD	MFO	SHMD	PRMD
•				•		

Custom Door and Drawer Front Options

DAPNL_/4	DAPNL_/4P	DADOORB	DADOORHG	DOORBL	DOORBR	DOORSLAB	DA5PCDF	DASLBDF
•							•	•



3/4" door profile



3/4" drawer front profile

- Slab Door and Drawer Front
- Veneer Face and Back
- Veneer Edging on all Edges
- Furniture Board Core

- Vertical Grain Pattern
- Full Overlay
- When ordered in MDF, all door and drawer front components will be in MDF.

Special Notes:

- VWM_ cabinets are not available with this door style.
- DASLBDF grain direction is vertical on this door style.

DOOR STYLES

Slim FO

	Cherry	Maple*	MDF	Oak	Rustic Alder	Rustic Hickory	PureStyle™	Specialty Laminate
Price Point	5	3	—	2	—	—	—	—

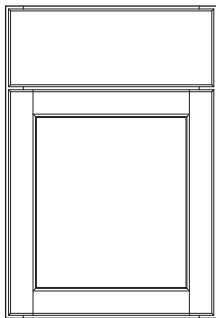

Base

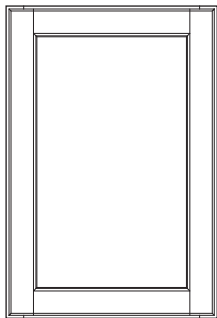

Wall

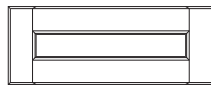

Optional Drawer Front:
Flat 5-piece (DFF5PC and DFF5PCSLBT)

Door Options

ALF	CG	DPSRR	MD	MFO	SHMD	PRMD
•	•	•	•	•	•	•

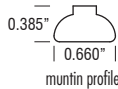

Custom Door and Drawer Front Options

DAPNL /4	DAPNL /4P	DADOORB	DADOORHG	DOORBL	DOORBR	DOORSLAB	DASPCDF	DASLBDF
•	•	•	•	•	•	•	•	•

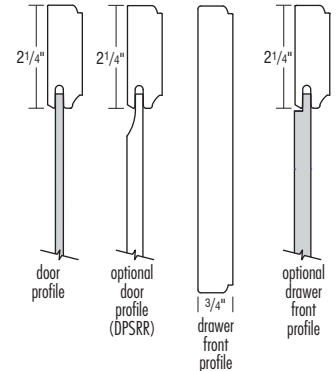

- Veneer Flat Panel
- Full Overlay
- Profiled Slab Drawer Front

- See chart to the right for 5-piece drawer front dimensions representative of a 9" wide base cabinet when specifying decorative hardware.

*When a Paint or Paint with Glaze finish is specified, the door and/or drawer front center panel may be constructed of Medium Density Fiberboard (MDF), except when Heirlooming is specified. MDF provides a smoother finish when painted, and is more resistant to warping, expansion, and contraction. Doors, drawer fronts, and additional facings may consist of other hardwood components.

5-piece Drawer Front Dimensions

Drawer Front Width	8 1/2"
Drawer Front Height	6 1/4"
Panel Flat Width	4"
Panel Flat Height	1 3/4"

Slim PO

	Cherry	Maple*	MDF	Oak	Rustic Alder	Rustic Hickory	PureStyle™	Specialty Laminate
Price Point	4	2	—	1	—	—	—	—

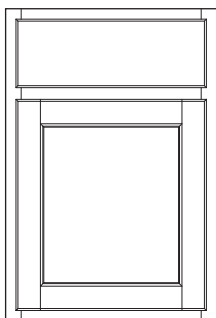

Base

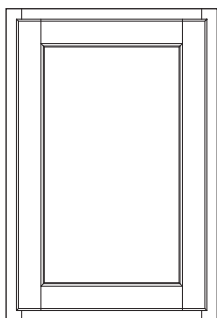

Wall

Door Options

ALF	CG	DPSRR	MD	MFO	SHMD	PRMD
•	•	•	•	•	•	•

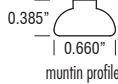

Custom Door and Drawer Front Options

DAPNL /4	DAPNL /4P	DADOORB	DADOORHG	DOORBL	DOORBR	DOORSLAB	DASPCDF	DASLBDF
•	•	•	•	•	•	•	•	•

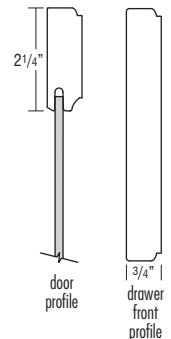

- Veneer Flat Panel
- Partial Overlay
- Profiled Slab Drawer Front

*When a Paint or Paint with Glaze finish is specified, the door center panel may be constructed of Medium Density Fiberboard (MDF), except when Heirlooming is specified. MDF provides a smoother finish when painted, and is more resistant to warping, expansion, and contraction. Doors, drawer fronts, and additional facings may consist of other hardwood components.

Special Notes:

- CH and CW modifications are not available with this door style.

DOOR STYLES

Stevenson FO

	Cherry	Maple*	MDF	Oak	Rustic Alder	Rustic Hickory	PureStyle™	Specialty Laminate
Price Point	10	9	—	—	—	—	—	—

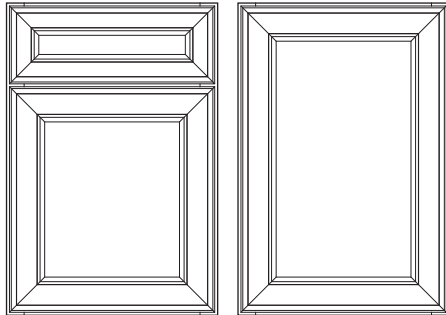

Base

Wall

Door Options

ALF	CG	DPSRR	MD	MFO	SHMD	PRMD
•	•	•	•	•	•	•

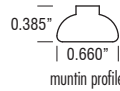

Custom Door and Drawer Front Options

DAPNL_ /4	DAPNL_ /4P	DADOORB	DADOORHG	DOORBL	DOORBR	DOORSLAB	DA5PCDF	DASLBDF
•	•	•	•	•	•	•	•	•

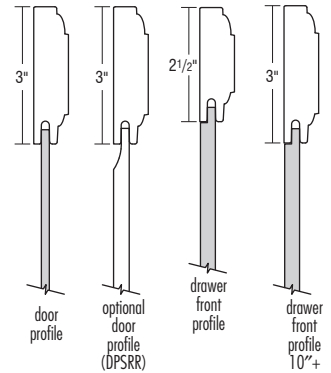

- Veneer Flat Panel Mitered Door
- Full Overlay
- 5-piece Drawer Front Mitered to Match Door

- See chart to the right for 5-piece drawer front dimensions representative of a 9" wide base cabinet when specifying decorative hardware.

*When a Paint or Paint with Glaze finish is specified, the door and/or drawer front center panel may be constructed of Medium Density Fiberboard (MDF), except when Heirlooming is specified. MDF provides a smoother finish when painted, and is more resistant to warping, expansion, and contraction. Doors, drawer fronts, and additional facings may consist of other hardwood components.

Special Notes:

- CH and CW modifications are not available with this door style.
- Silhouette glass is not recommended for use with this door style.

5-piece Drawer Front Dimensions

Drawer Front Width	8 1/2"
Drawer Front Height	6 1/4"
Panel Flat Width	3 1/2"
Panel Flat Height	1 1/4"

Traditional FO

	Cherry	Maple*	MDF	Oak	Rustic Alder	Rustic Hickory	PureStyle™	Specialty Laminate
Price Point	6	4	—	3	—	—	—	—

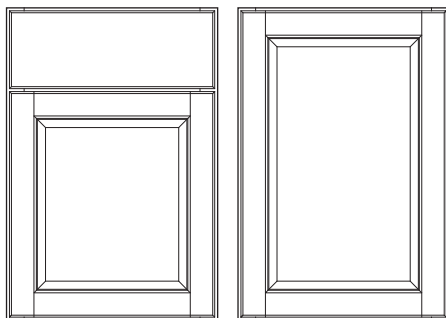

Base

Wall

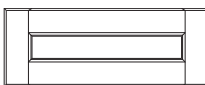

Optional Drawer Front:
Flat 5-piece (DFF5PC and DFF5PCSLBT)

Door Options

ALF	CG	DPSRR	MD	MFO	SHMD	PRMD
•	•	•	•	•	•	•

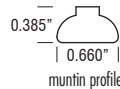

Custom Door and Drawer Front Options

DAPNL_ /4	DAPNL_ /4P	DADOORB	DADOORHG	DOORBL	DOORBR	DOORSLAB	DA5PCDF	DASLBDF
•	•	•	•	•	•	•	•	•

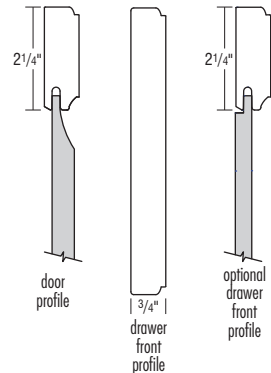

- Veneer Raised Panel
- Full Overlay
- Profiled Slab Drawer Front

- See chart to the right for 5-piece drawer front dimensions representative of a 9" wide base cabinet when specifying decorative hardware.

*When a Paint or Paint with Glaze finish is specified, the door and/or drawer front center panel may be constructed of Medium Density Fiberboard (MDF). MDF provides a smoother finish when painted, and is more resistant to warping, expansion, and contraction. Doors, drawer fronts, and additional facings may consist of other hardwood components.

5-piece Drawer Front Dimensions

Drawer Front Width	8 1/2"
Drawer Front Height	6 1/4"
Panel Flat Width	4"
Panel Flat Height	1 3/4"

DOOR STYLES

Traditional PO

	Cherry	Maple*	MDF	Oak	Rustic Alder	Rustic Hickory	PureStyle™	Specialty Laminate
Price Point	5	3	—	2	—	—	—	—

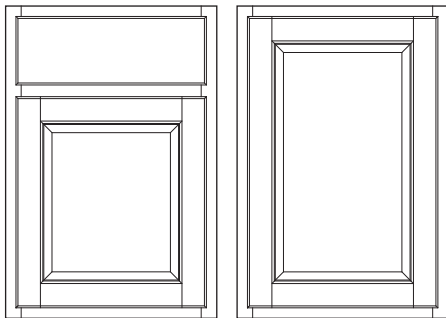

Base Wall

Door Options

ALF	CG	DPSRR	MD	MFO	SHMD	PRMD
•	•	•	•	•	•	•

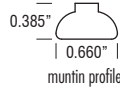

Custom Door and Drawer Front Options

DAPNL /4	DAPNL /4P	DADOORB	DADOORHG	DOORBL	DOORBR	DOORSLAB	DA5PCDF	DASLBDF
•	•	•	•	•	•	•	•	•

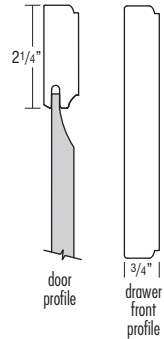

- Veneer Raised Panel
- Partial Overlay
- Profiled Slab Drawer Front

*When a Paint or Paint with Glaze finish is specified, the door center panel may be constructed of Medium Density Fiberboard (MDF). MDF provides a smoother finish when painted, and is more resistant to warping, expansion, and contraction. Doors, drawer fronts, and additional facings may consist of other hardwood components.

Special Notes:

- CH and CW modifications are not available with this door style.

Windsor

	Cherry	Maple	MDF	Oak	Rustic Alder	Rustic Hickory	PureStyle™	Specialty Laminate
Price Point	—	6	—	—	—	—	—	—

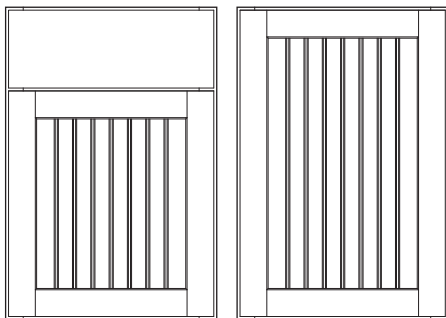

Base Wall

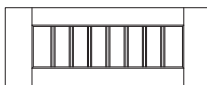

Optional Drawer Front:
Flat 5-piece (DFF5PC and DFF5PCSLBT)

Door Options

ALF	CG	DPSRR	MD	MFO	SHMD	PRMD
•	•	•	•	•	•	•

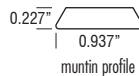

Custom Door and Drawer Front Options

DAPNL /4	DAPNL /4P	DADOORB	DADOORHG	DOORBL	DOORBR	DOORSLAB	DA5PCDF	DASLBDF
•	•	•	•	•	•	•	•	•

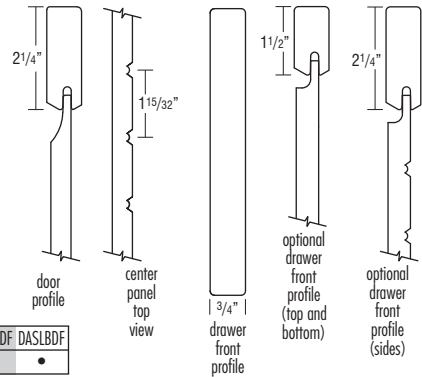

- Solid Reverse Raised Beaded Panel
- Full Overlay
- Slab Drawer Front
- Will not use MDF center panel on Paint finishes. See Door Style Specifications page for more details.
- Beaded center panel on 5-piece drawer fronts will not align with doors when used on cabinets with double doors and a full width drawer.

- See chart to the right for 5-piece drawer front dimensions representative of a 9" wide base cabinet when specifying decorative hardware.

Special Notes:

- CH and CW modifications are not available with this door style.
- WTH_ and WVL_ cabinets are not available with this door style.
- BP_VG SKUs do not match spacing on this door style.
- DADOORB in this door style has a maximum width of 23 1/2" for a single width center panel; doors between 23 9/16" and 35 3/4" wide have a center mullion between the center panels.
- DA5PCDF grain direction is vertical on this door style. Maximum width for DA5PCDF on this door style is 23 1/2".
- When DFF5PC is selected with this door style on a 2DB48, drawer front will have a vertical cross rail with two center panels.

5-piece Drawer Front Dimensions

Drawer Front Width	8 1/2"
Drawer Front Height	6 1/4"
Panel Flat Width	4"
Panel Flat Height	3 1/4"

DOOR STYLES

Witten FO

	Cherry	Maple*	MDF	Oak	Rustic Alder	Rustic Hickory	PureStyle™	Specialty Laminate
Price Point	8	6	—	5	8	8	—	—

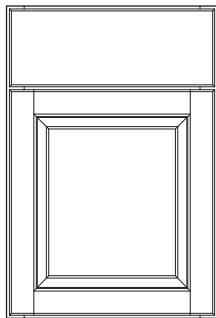

Base

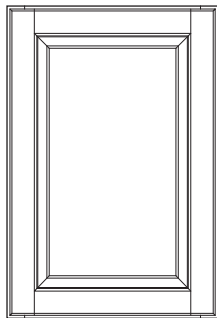

Wall

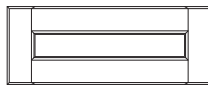

Optional Drawer Front:
Flat 5-piece (DFF5PC and DFF5PCSLBT)

Door Options

ALF	CG	DPSRR	MD	MFO	SHMD	PRMD
•	•	•	•	•	•	•

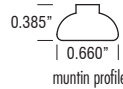

Custom Door and Drawer Front Options

DAPNL_	/4	DAPNL_	/4P	DADOORB	DADOORHG	DOORBL	DOORBR	DOORSLAB	DA5PCDF	DASLBDF
•	•	•	•	•	•	•	•	•	•	•

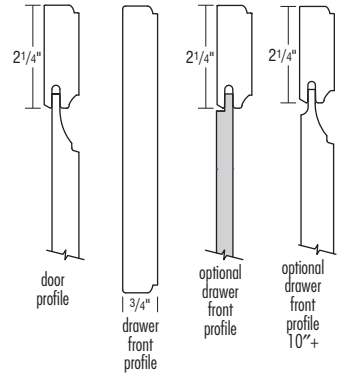

- Solid Raised Panel
- Full Overlay
- Profiled Slab Drawer Front

- See chart to the right for 5-piece drawer front dimensions representative of a 9" wide base cabinet when specifying decorative hardware.

*When a Paint or Paint with Glaze finish is specified, the door and/or drawer front center panel may be constructed of Medium Density Fiberboard (MDF), except when Heirlooming is specified. MDF provides a smoother finish when painted, and is more resistant to warping, expansion, and contraction. Doors, drawer fronts, and additional facings may consist of other hardwood components.

5-piece Drawer Front Dimensions

Drawer Front Width	8 1/2"
Drawer Front Height	6 1/4"
Panel Flat Width	4"
Panel Flat Height	1 3/4"

Witten PO

	Cherry	Maple*	MDF	Oak	Rustic Alder	Rustic Hickory	PureStyle™	Specialty Laminate
Price Point	6	4	—	3	6	6	—	—

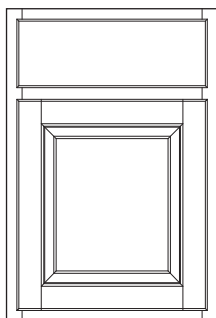

Base

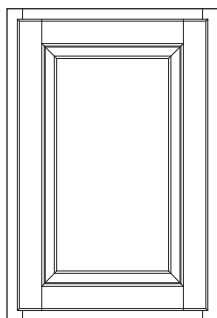

Wall

Door Options

ALF	CG	DPSRR	MD	MFO	SHMD	PRMD
•	•	•	•	•	•	•

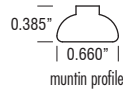

Custom Door and Drawer Front Options

DAPNL_	/4	DAPNL_	/4P	DADOORB	DADOORHG	DOORBL	DOORBR	DOORSLAB	DA5PCDF	DASLBDF
•	•	•	•	•	•	•	•	•	•	•

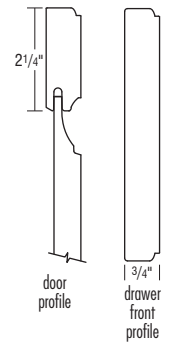



- Solid Raised Panel
- Partial Overlay
- Profiled Slab Drawer Front

*When a Paint or Paint with Glaze finish is specified, the door center panel may be constructed of Medium Density Fiberboard (MDF), except when Heirlooming is specified. MDF provides a smoother finish when painted, and is more resistant to warping, expansion, and contraction. Doors, drawer fronts, and additional facings may consist of other hardwood components.

Special Notes:

- CH and CW modifications are not available with this door style.

PREMIUM COLOR PALETTE

	OPTION NAME	DESCRIPTION	MATCHING LAMINATE ENDS [▲]	UPCHARGE**	HEIRLOOMING AVAILABILITY	MATTE SHEEN AVAILABILITY
Stains	Storm	A semi translucent stone gray finish that allows the natural tones and characteristics of the wood to show through.	Maple ✓ Cherry N/A	15%	N/A	✓
	Amaretto Crème	A dark spicy brown glaze that defines style profile features with high contrast.	✓	15%	N/A	✓
Panned Glazes for Stains	Charcoal	A dusty black glaze that establishes a dark, defining shadow in profile details for added interest.	✓	15%	N/A	✓
	Toasted Almond	A medium, nutty brown glaze that lends richness to style details.	✓	15%	N/A	✓
	Black	True black	✓	15%	✓	N/A
Paints*	Brightest White	Brightest, purest white	✓	10%	N/A	N/A
	Cloud	Medium gray	✓	10%	N/A	N/A
	Coconut	Creamy off white	✓	10%	N/A	N/A
	Foxhall Green	Deep green	✓	15%	✓	N/A
	Icy Avalanche	Cool white with gray undertones	✓	10%	N/A	N/A
	Marcona 	Soft, creamy off-white	✓	10%	N/A	N/A
	Maritime	Dark navy with gray/green undertones	✓	10%	✓	N/A
	Moonstone	Cool dark gray	✓	10%	✓	N/A
	Naval	Classic navy	✓	15%	✓	N/A
	Retreat 	Medium gray color with blue green undertones	✓	10%	N/A	N/A
	Steam	Pale, milky white	✓	10%	N/A	N/A
	White	Pure white	✓	10%	N/A	N/A
	Panned Glazes for Paints*	Amaretto Crème	A dark spicy brown glaze that defines style profile features with high contrast.	✓	15%	N/A
Charcoal		A dusty black glaze that establishes a dark, defining shadow in profile details for added interest.	✓	15%	N/A	N/A
Grey Stone		A softer, muted gray glaze that subtly highlights and draws attention to profile features.	✓	15%	N/A	N/A
Toasted Almond		A medium, nutty brown glaze that lends richness to style details.	✓	15%	N/A	N/A

[▲]In Standard construction, cabinets will have matching laminate ends. Where not available, ends will be Natural Maple laminate and a finished end treatment would be needed for an exposed end.

*On wood products, normal movement is typical due to change in climatic conditions. This will cause hairline cracks at stile, rail and panel joints. This hairline cracking is a normal characteristic of painted finishes and will not be considered a reason for product replacement. Finish agreement required, see Policies section at the end of the book.

**Cabinet list includes cabinet price plus any modifications except APC, ET, and PE.

F26

PREMIUM COLOR PALETTE

COLOR BY NUMBER PROGRAM

Mid Continent® Signature™ has partnered with Sherwin-Williams® and Benjamin Moore® to bring thousands of paint color options to our customers in search of the perfect option to suit their vision. The Sherwin-Williams® and Benjamin Moore® Paint Palettes offer paint colors found at stores or online and these broad palettes are available on Maple and MDF.

Your satisfaction is important to Mid Continent Signature so we want you to fully understand the characteristics that make painted finishes so distinctive. It is important to realize that the true beauty of wood cabinetry comes from natural qualities of the wood itself. The textures of natural grain patterns often remain visible in some species and should be accepted as inherent characteristics when selecting cabinetry. When painted finishes are specified, the center panels of the selected style may be constructed of Medium Density Fiberboard (MDF). MDF provides a smoother finish when painted, and is more resistant to warping, expansion and contraction. Doors, drawer fronts, and additional facings may consist of other hardwood components.

Paint finishes are different from standard wood finishes. On all wood products, expansion and contraction are typical due to changes in climate conditions. Due to this normal movement, paint finishes may develop slight separation lines, finish breaks, and seam lines. These will be most notable at stile, rail and panel joints. Joint separation may become more noticeable over time and through several changes. Also over time, there may be slight color shift in these finishes due to continued exposure to natural and artificial light sources and other environmental factors. We mention these characteristics because neither Mid Continent Signature nor your dealer can be held responsible for these conditions and variations.

Paint samples are shown on materials other than wood. Wood will have a different appearance when the color is applied to the actual door or cabinet. This is due to different material properties, textures and sheen. Normal color variation is found from “color swatch to color swatch” and from “paper media to solid wood”.

No changes or cancellations will be accepted after 24 hours from acknowledgment of order.

Quantity of two PAINTPEN will come with original order. PAINTPEN-ADD will allow up to 2 additional pens to be ordered with the original order only.

Code	Description	Price Per Pen
PAINTPEN	Paint Pen Qty. 2	Free with Original Order
PAINTPEN-ADD	Paint Pen Additional	\$54 per Additional Paint Pen with Original Order

When choosing Color By Number, all construction platforms are available. On standard construction, ends will be Natural Maple laminate interior and exterior. Color By Number will not be available on laminate panels.

F27

COLOR BY NUMBER PROGRAM

UNFINISHED

OPTION NAME	DESCRIPTION/LIMITATIONS	UPCHARGE	HEIRLOOMING AVAILABILITY
Unfinished	Must upgrade to PE or APC. When cabinets are finished by an outside source, finish is not covered under warranty. Interiors of cabinets will be Natural Maple laminate. For finishable interiors, MIP must be specified. Cabinets have a species-matching veneer for finishable plywood ends.	No Upcharge	N/A

FINISH TECHNIQUES

OPTION NAME	DESCRIPTION	UPCHARGE
Heirlooming	<p>Available on dark paints on Maple and Oak. Available on select finishes. The finish will be sanded through the base coat to expose the surface of the wood. This type of sand through on the edges and profiles creates a naturally worn appearance. If a finish is chosen with a glaze, the glaze will be applied after the sanding has been done. This will enhance those areas of exposed wood to take on the darker characteristic of the applied glaze. Not available on Rohe, Slab FO, Traditional FO, and Traditional PO.</p> <p>Select trim pieces will feature Heirlooming characteristics. See Trim section for availability.</p>	5% + any applicable premium finish upcharge

SHEEN OPTION

OPTION NAME	DESCRIPTION	UPCHARGE
Matte Sheen	<p>Available on Stains and Stains with Penned Glazes.</p> <p>Replaces standard top coat with a low sheen, non-pigmented top coat on doors, drawer fronts, face frames, trim items, and veneer finished cabinet components in selected finish. Does not affect laminate or clear finished components.</p>	No Upcharge

F28

UNFINISHED / FINISH TECHNIQUES

12-STEP FINISHING PROCESS

- 1. Wood Selection** – The selection of the finest woods is the essential first step of our 12-step finishing process.
- 2. Sanded to Perfection** – Our sanding utilizes a fine grit paper, both with and against the wood grain. This process is completed on a vacuum table, allowing for a wood surface that is free of dust particles.
- 3. Achieving Natural Wood Tone** – Toner is applied to selected finishes, enhancing the naturalistic wood appearance.
- 4. Stain Application** – A hand-sprayed deep penetrating stain is evenly applied to all surfaces for even coverage on all profiles. On multi-step stains and glaze finishes, some non-facing surfaces (such as backs of doors, backs of panels, and matching veneer interiors) may not receive all steps noted. The resulting finish will be complementary and similar in color and have the same catalyzed top coat and cure, but may not result in the same color depth as facing surfaces.
- 5. Removal of Excess Stain** – The wood is hand-wiped to remove excess stain, emphasizing the cabinet's natural wood grain.
- 6. Catalyzed Sealer** – A tough, clear, catalyzed sealer is hand-sprayed on to protect the grain from moisture.
- 7. Drying Process** – For added durability, the sealed wood is oven cured to lock in the beauty of wood.
- 8. Hand-Sanded** – To achieve an ultra-smooth finish, we hand-sand the material one last time.
- 9. Dust Removal** – The resulting loose dust particles are removed from the surface of the wood.
- 10. Catalyzed Top Coat** – A premium quality catalyzed clear top coat is applied to protect the wood from environmental elements.
- 11. Final Top Coat Cure** – The top coat is cured to guarantee the strongest, most beautiful finish.
- 12. Final Inspection** – This last inspection is very thorough, ensuring quality and beauty. Our gift to you is that every cabinet is crafted with care.

CHARACTERISTICS OF GLAZING/PAINT

Penned Glazes

A professional layer of glaze can add another layer of beauty to your cabinets. Our hand-detailed penned glaze application adds depth and dimension to your cabinet's appearance by highlighting the profile of your door style choice.

- Hand-detailed penned glazing will leave a consistent, “penned” appearance around the door profile, and will not change the overall finish or paint base color.
- You should expect the result to yield a subtle to dramatic look based on the complexity of a cabinet door's design.
- Printed materials and online, electronic presentations can only do so much. It's important to both see and touch actual finished samples to ensure your satisfaction.









Paint Finish

Paint may develop hairline cracks in the finish, most notable around the joints. This is a result of natural expansion and contraction of the genuine hardwoods used in the manufacturing of this product. Hairline cracks are not considered a defect in the cabinetry or finish.

FINISH AVAILABILITY

F30

FINISH AVAILABILITY





		MAPLE																																			
		Penned Glaze	Matching Laminate Ends [▲]	Upcharge	Heirloom [*] 	Matte Sheen	Berkley FO	Berkley PO	Brawny FO	Celina	Danielson	Dapper FO	Detailed FO	Detailed PO	Garland	Glyndon	Healy 	Henri 	Jasper	Paquette	Payson	Perry FO	Rohe	Sanford	Simple FO	Simple PO	Slab FO	Slim FO	Slim PO	Stevenson FO	Traditional FO	Traditional PO	Windsor	Written FO	Written PO		
		Stains	Boardwalk	✓	✓			✓	✓	✓	✓	✓	✓	✓	✓	✓	✓	✓	✓	✓	✓	✓	✓	✓	✓	✓	✓	✓	✓	✓	✓	✓	✓	✓	✓	✓	✓
Buckskin	✓		✓			✓	✓	✓	✓	✓	✓	✓	✓	✓	✓	✓	✓	✓	✓	✓	✓	✓	✓	✓	✓	✓	✓	✓	✓	✓	✓	✓	✓	✓	✓		
Cattail	✓		✓			✓	✓	✓	✓	✓	✓	✓	✓	✓	✓	✓	✓	✓	✓	✓	✓	✓	✓	✓	✓	✓	✓	✓	✓	✓	✓	✓	✓	✓	✓	✓	
Chocolate			✓			✓	✓	✓	✓	✓	✓	✓	✓	✓	✓	✓	✓	✓	✓	✓	✓	✓	✓	✓	✓	✓	✓	✓	✓	✓	✓	✓	✓	✓	✓	✓	
Colt	✓		✓			✓	✓	✓	✓	✓	✓	✓	✓	✓	✓	✓	✓	✓	✓	✓	✓	✓	✓	✓	✓	✓	✓	✓	✓	✓	✓	✓	✓	✓	✓	✓	
Kanga	✓		✓			✓	✓	✓	✓	✓	✓	✓	✓	✓	✓	✓	✓	✓	✓	✓	✓	✓	✓	✓	✓	✓	✓	✓	✓	✓	✓	✓	✓	✓	✓	✓	✓
Morel	✓		✓			✓	✓	✓	✓	✓	✓	✓	✓	✓	✓	✓	✓	✓	✓	✓	✓	✓	✓	✓	✓	✓	✓	✓	✓	✓	✓	✓	✓	✓	✓	✓	✓
Natural	✓		✓			✓	✓	✓	✓	✓	✓	✓	✓	✓	✓	✓	✓	✓	✓	✓	✓	✓	✓	✓	✓	✓	✓	✓	✓	✓	✓	✓	✓	✓	✓	✓	✓
Sahara	✓		✓			✓	✓	✓	✓	✓	✓	✓	✓	✓	✓	✓	✓	✓	✓	✓	✓	✓	✓	✓	✓	✓	✓	✓	✓	✓	✓	✓	✓	✓	✓	✓	✓
Seal			✓			✓	✓	✓	✓	✓	✓	✓	✓	✓	✓	✓	✓	✓	✓	✓	✓	✓	✓	✓	✓	✓	✓	✓	✓	✓	✓	✓	✓	✓	✓	✓	✓
Storm			✓	15%		✓	✓	✓	✓	✓	✓	✓	✓	✓	✓	✓	✓	✓	✓	✓	✓	✓	✓	✓	✓	✓	✓	✓	✓	✓	✓	✓	✓	✓	✓	✓	✓
Thatch	✓		✓			✓	✓	✓	✓	✓	✓	✓	✓	✓	✓	✓	✓	✓	✓	✓	✓	✓	✓	✓	✓	✓	✓	✓	✓	✓	✓	✓	✓	✓	✓	✓	✓
Titanium			✓			✓	✓	✓	✓	✓	✓	✓	✓	✓	✓	✓	✓	✓	✓	✓	✓	✓	✓	✓	✓	✓	✓	✓	✓	✓	✓	✓	✓	✓	✓	✓	✓
Tundra	✓		✓			✓	✓	✓	✓	✓	✓	✓	✓	✓	✓	✓	✓	✓	✓	✓	✓	✓	✓	✓	✓	✓	✓	✓	✓	✓	✓	✓	✓	✓	✓	✓	✓
Unfinished							✓	✓	✓	✓	✓	✓	✓	✓	✓	✓	✓	✓	✓	✓	✓	✓	✓	✓	✓	✓	✓	✓	✓	✓	✓	✓	✓	✓	✓	✓	✓
Penned Glaze for Stains	Amaretto Crème Charcoal Toasted Almond		✓	15%		✓	✓	✓	✓	✓	✓	✓	✓	✓	✓	✓	✓	✓	✓	✓	✓	✓	✓	✓	✓	✓	✓	✓	✓	✓	✓	✓	✓	✓	✓	✓	
Paints 	Black		✓	15%	5%	✓	✓	✓	✓	✓	✓	✓	✓	✓	✓	✓	✓	✓	✓	✓	✓	✓	✓	✓	✓	✓	✓	✓	✓	✓	✓	✓	✓	✓	✓	✓	
	Brightest White	✓	✓	10%		✓	✓	✓	✓	✓	✓	✓	✓	✓	✓	✓	✓	✓	✓	✓	✓	✓	✓	✓	✓	✓	✓	✓	✓	✓	✓	✓	✓	✓	✓	✓	
	Cloud	✓	✓	10%		✓	✓	✓	✓	✓	✓	✓	✓	✓	✓	✓	✓	✓	✓	✓	✓	✓	✓	✓	✓	✓	✓	✓	✓	✓	✓	✓	✓	✓	✓	✓	
	Coconut	✓	✓	10%		✓	✓	✓	✓	✓	✓	✓	✓	✓	✓	✓	✓	✓	✓	✓	✓	✓	✓	✓	✓	✓	✓	✓	✓	✓	✓	✓	✓	✓	✓	✓	✓
	Foxhall Green		✓	15%	5%	✓	✓	✓	✓	✓	✓	✓	✓	✓	✓	✓	✓	✓	✓	✓	✓	✓	✓	✓	✓	✓	✓	✓	✓	✓	✓	✓	✓	✓	✓	✓	
	Icy Avalanche	✓	✓	10%		✓	✓	✓	✓	✓	✓	✓	✓	✓	✓	✓	✓	✓	✓	✓	✓	✓	✓	✓	✓	✓	✓	✓	✓	✓	✓	✓	✓	✓	✓	✓	✓
	Marcona 	✓	✓	10%		✓	✓	✓	✓	✓	✓	✓	✓	✓	✓	✓	✓	✓	✓	✓	✓	✓	✓	✓	✓	✓	✓	✓	✓	✓	✓	✓	✓	✓	✓	✓	✓
	Maritime		✓	10%	5%	✓	✓	✓	✓	✓	✓	✓	✓	✓	✓	✓	✓	✓	✓	✓	✓	✓	✓	✓	✓	✓	✓	✓	✓	✓	✓	✓	✓	✓	✓	✓	✓
	Moonstone		✓	10%	5%	✓	✓	✓	✓	✓	✓	✓	✓	✓	✓	✓	✓	✓	✓	✓	✓	✓	✓	✓	✓	✓	✓	✓	✓	✓	✓	✓	✓	✓	✓	✓	✓
	Naval		✓	15%	5%	✓	✓	✓	✓	✓	✓	✓	✓	✓	✓	✓	✓	✓	✓	✓	✓	✓	✓	✓	✓	✓	✓	✓	✓	✓	✓	✓	✓	✓	✓	✓	✓
	Retreat 	✓	✓	10%		✓	✓	✓	✓	✓	✓	✓	✓	✓	✓	✓	✓	✓	✓	✓	✓	✓	✓	✓	✓	✓	✓	✓	✓	✓	✓	✓	✓	✓	✓	✓	✓
	Steam	✓	✓	10%		✓	✓	✓	✓	✓	✓	✓	✓	✓	✓	✓	✓	✓	✓	✓	✓	✓	✓	✓	✓	✓	✓	✓	✓	✓	✓	✓	✓	✓	✓	✓	✓
White	✓	✓	10%		✓	✓	✓	✓	✓	✓	✓	✓	✓	✓	✓	✓	✓	✓	✓	✓	✓	✓	✓	✓	✓	✓	✓	✓	✓	✓	✓	✓	✓	✓	✓	✓	
Penned Glaze for Paints 	Amaretto Crème Charcoal Grey Stone Toasted Almond		✓	15%		✓	✓	✓	✓	✓	✓	✓	✓	✓	✓	✓	✓	✓	✓	✓	✓	✓	✓	✓	✓	✓	✓	✓	✓	✓	✓	✓	✓	✓	✓	✓	
Color By Number 	Sherwin-Williams Color Palette Benjamin Moore Color Portfolio			20%		✓	✓	✓	✓	✓	✓	✓	✓	✓	✓	✓	✓	✓	✓	✓	✓	✓	✓	✓	✓	✓	✓	✓	✓	✓	✓	✓	✓	✓	✓	✓	

*Heirloom upcharge is in addition to other finish upcharges. Heirloom not available on Rohe, Slab FO, Traditional FO, and Traditional PO.

▲In Standard construction, cabinets will have matching laminate ends. Where not available, ends will be Natural Maple laminate and a finished end treatment would be needed for an exposed end.

 Signed finish agreement required, see Policies section at the end of the book.

FINISH AVAILABILITY

				MDF			
				Brawny FO	Danielson	Simple FO	Slab FO
				Penned Glaze	Matching Laminate Ends [▲]	Upcharge	
Paints 	Black		✓	15%	✓	✓	✓
	Brightest White	✓	✓	10%	✓	✓	✓
	Cloud	✓	✓	10%	✓	✓	✓
	Coconut	✓	✓	10%	✓	✓	✓
	Foxhall Green		✓	15%	✓	✓	✓
	Icy Avalanche	✓	✓	10%	✓	✓	✓
	Marcona 	✓	✓	10%	✓	✓	✓
	Maritime		✓	10%	✓	✓	✓
	Moonstone		✓	10%	✓	✓	✓
	Naval		✓	15%	✓	✓	✓
	Retreat 	✓	✓	10%	✓	✓	✓
	Steam	✓	✓	10%	✓	✓	✓
	White	✓	✓	10%	✓	✓	✓
Penned Glaze for Paints 	Amaretto Crème		✓	15%	✓	✓	
	Charcoal						
	Grey Stone						
	Toasted Almond						
Color By Number 	Sherwin-Williams Color Palette			20%	✓	✓	✓
	Benjamin Moore Color Portfolio						

F31

FINISH AVAILABILITY

▲In Standard construction, cabinets will have matching laminate ends. Where not available, ends will be Natural Maple laminate and a finished end treatment would be needed for an exposed end.
 Signed finish agreement required, see Policies section at the end of the book.

FINISH AVAILABILITY

F32

FINISH AVAILABILITY

		CHERRY																													
		Penned Glaze	Matching Laminate Ends [^]	Upcharge	Matte Sheen	Brawny FO	Celina	Danielson	Dapper FO	Detailed FO	Detailed PO	Garland	Glyndon	Healy	Henri 	Jasper	Paquette	Payson	Perry FO	Rohe	Sanford	Simple FO	Slab FO	Slim FO	Slim PO	Stevenson FO	Traditional FO	Traditional PO	Witten FO	Witten PO	
Stains	Boardwalk	✓	✓		✓	✓	✓	✓	✓	✓	✓	✓	✓	✓	✓	✓	✓	✓	✓	✓	✓	✓	✓	✓	✓	✓	✓	✓	✓	✓	
	Buckskin	✓	✓		✓	✓	✓	✓	✓	✓	✓	✓	✓	✓	✓	✓	✓	✓	✓	✓	✓	✓	✓	✓	✓	✓	✓	✓	✓	✓	
	Cattail	✓	✓		✓	✓	✓	✓	✓	✓	✓	✓	✓	✓	✓	✓	✓	✓	✓	✓	✓	✓	✓	✓	✓	✓	✓	✓	✓	✓	
	Chocolate		✓		✓	✓	✓	✓	✓	✓	✓	✓	✓	✓	✓	✓	✓	✓	✓	✓	✓	✓	✓	✓	✓	✓	✓	✓	✓	✓	
	Colt	✓	✓		✓	✓	✓	✓	✓	✓	✓	✓	✓	✓	✓	✓	✓	✓	✓	✓	✓	✓	✓	✓	✓	✓	✓	✓	✓	✓	✓
	Kanga	✓	✓		✓	✓	✓	✓	✓	✓	✓	✓	✓	✓	✓	✓	✓	✓	✓	✓	✓	✓	✓	✓	✓	✓	✓	✓	✓	✓	✓
	Light		✓		✓	✓	✓	✓	✓	✓	✓	✓	✓	✓	✓	✓	✓	✓	✓	✓	✓	✓	✓	✓	✓	✓	✓	✓	✓	✓	✓
	Morel	✓	✓		✓	✓	✓	✓	✓	✓	✓	✓	✓	✓	✓	✓	✓	✓	✓	✓	✓	✓	✓	✓	✓	✓	✓	✓	✓	✓	✓
	Natural	✓	✓		✓	✓	✓	✓	✓	✓	✓	✓	✓	✓	✓	✓	✓	✓	✓	✓	✓	✓	✓	✓	✓	✓	✓	✓	✓	✓	✓
	Sahara	✓	✓		✓	✓	✓	✓	✓	✓	✓	✓	✓	✓	✓	✓	✓	✓	✓	✓	✓	✓	✓	✓	✓	✓	✓	✓	✓	✓	✓
	Seal		✓		✓	✓	✓	✓	✓	✓	✓	✓	✓	✓	✓	✓	✓	✓	✓	✓	✓	✓	✓	✓	✓	✓	✓	✓	✓	✓	✓
	Storm			15%	✓	✓	✓	✓	✓	✓	✓	✓	✓	✓	✓	✓	✓	✓	✓	✓	✓	✓	✓	✓	✓	✓	✓	✓	✓	✓	✓
	Thatch	✓	✓		✓	✓	✓	✓	✓	✓	✓	✓	✓	✓	✓	✓	✓	✓	✓	✓	✓	✓	✓	✓	✓	✓	✓	✓	✓	✓	✓
	Titanium		✓		✓	✓	✓	✓	✓	✓	✓	✓	✓	✓	✓	✓	✓	✓	✓	✓	✓	✓	✓	✓	✓	✓	✓	✓	✓	✓	✓
	Tundra	✓	✓		✓	✓	✓	✓	✓	✓	✓	✓	✓	✓	✓	✓	✓	✓	✓	✓	✓	✓	✓	✓	✓	✓	✓	✓	✓	✓	✓
Unfinished					✓	✓	✓	✓	✓	✓	✓	✓	✓	✓	✓	✓	✓	✓	✓	✓	✓	✓	✓	✓	✓	✓	✓	✓	✓	✓	
Penned Glaze for Stains	Amaretto Crème		✓	15%	✓	✓			✓	✓	✓	✓	✓	✓	✓		✓	✓	✓		✓	✓		✓	✓	✓	✓	✓	✓	✓	
	Charcoal																														
	Toasted Almond																														

[^]In Standard construction, cabinets will have matching laminate ends. Where not available, ends will be Natural Maple laminate and a finished end treatment would be needed for an exposed end. Cherry laminate components are intentionally slightly darker than cabinet facings at the time of manufacturing to compensate for the expected darkening of doors, drawer fronts, etc., as they are exposed to natural sunlight.

FINISH AVAILABILITY

		RUSTIC ALDER 										
		Penned Glaze	Matching Laminate Ends [▲]	Upcharge	Matte Sheen	Brawny FO	Glyndon	Payson	Simple FO	Simple PO	Wirren FO	Wirren PO
Stains	Boardwalk	✓	✓		✓	✓	✓	✓	✓	✓	✓	✓
	Buckskin	✓	✓		✓	✓	✓	✓	✓	✓	✓	✓
	Cattail	✓	✓		✓	✓	✓	✓	✓	✓	✓	✓
	Chocolate		✓		✓	✓	✓	✓	✓	✓	✓	✓
	Colt	✓	✓		✓	✓	✓	✓	✓	✓	✓	✓
	Kanga	✓	✓		✓	✓	✓	✓	✓	✓	✓	✓
	Morel	✓	✓		✓	✓	✓	✓	✓	✓	✓	✓
	Natural	✓	✓		✓	✓	✓	✓	✓	✓	✓	✓
	Sahara	✓	✓		✓	✓	✓	✓	✓	✓	✓	✓
	Seal		✓		✓	✓	✓	✓	✓	✓	✓	✓
	Thatch	✓	✓		✓	✓	✓	✓	✓	✓	✓	✓
	Titanium		✓		✓	✓	✓	✓	✓	✓	✓	✓
	Tundra	✓	✓		✓	✓	✓	✓	✓	✓	✓	✓
	Unfinished					✓	✓	✓	✓	✓	✓	✓
Penned Glaze for Stains	Amaretto Crème Charcoal Toasted Almond		✓	15%	✓	✓	✓	✓	✓	✓	✓	✓

F33



FINISH AVAILABILITY

[▲]In Standard construction, cabinets will have matching laminate ends. Where not available, ends will be Natural Maple laminate and a finished end treatment would be needed for an exposed end.
 Signed finish agreement required, see Policies section at the end of the book.

FINISH AVAILABILITY

F34

FINISH AVAILABILITY

							RUSTIC HICKORY 							OAK												
		Penned Glaze	Matching Laminate Ends [▲]	Upcharge	Heirloom [*] 	Matte Sheen	Brawny FO	Dapper FO	Healy	Payson	Simple FO	Simple PO	Written FO	Written PO	Brawny FO	Dapper FO	Payson	Simple FO	Simple PO	Slim FO	Slim PO	Traditional FO	Traditional PO	Written FO	Written PO	
Stains	Boardwalk	✓	✓			✓	✓	✓	✓	✓	✓	✓	✓	✓	✓	✓	✓	✓	✓	✓	✓	✓	✓	✓	✓	
	Buckskin	✓	✓			✓	✓	✓	✓	✓	✓	✓	✓	✓	✓	✓	✓	✓	✓	✓	✓	✓	✓	✓	✓	
	Cattail	✓	✓			✓	✓	✓	✓	✓	✓	✓	✓	✓	✓	✓	✓	✓	✓	✓	✓	✓	✓	✓	✓	
	Chocolate		✓			✓									✓	✓	✓	✓	✓	✓	✓	✓	✓	✓	✓	
	Colt	✓	✓			✓	✓	✓	✓	✓	✓	✓	✓	✓	✓	✓	✓	✓	✓	✓	✓	✓	✓	✓	✓	
	Kanga	✓	✓			✓	✓	✓	✓	✓	✓	✓	✓	✓	✓	✓	✓	✓	✓	✓	✓	✓	✓	✓	✓	
	Light		✓			✓	✓	✓	✓	✓	✓	✓	✓	✓	✓	✓	✓	✓	✓	✓	✓	✓	✓	✓	✓	
	Morel	✓	✓			✓	✓	✓	✓	✓	✓	✓	✓	✓	✓	✓	✓	✓	✓	✓	✓	✓	✓	✓	✓	✓
	Natural	✓	✓			✓	✓	✓	✓	✓	✓	✓	✓	✓	✓	✓	✓	✓	✓	✓	✓	✓	✓	✓	✓	✓
	Sahara	✓	✓			✓	✓	✓	✓	✓	✓	✓	✓	✓	✓	✓	✓	✓	✓	✓	✓	✓	✓	✓	✓	✓
	Seal		✓			✓	✓	✓	✓	✓	✓	✓	✓	✓	✓	✓	✓	✓	✓	✓	✓	✓	✓	✓	✓	✓
	Thatch	✓	✓			✓	✓	✓	✓	✓	✓	✓	✓	✓	✓	✓	✓	✓	✓	✓	✓	✓	✓	✓	✓	✓
	Titanium		✓			✓	✓	✓	✓	✓	✓	✓	✓	✓	✓	✓	✓	✓	✓	✓	✓	✓	✓	✓	✓	✓
	Tundra	✓	✓			✓	✓	✓	✓	✓	✓	✓	✓	✓	✓	✓	✓	✓	✓	✓	✓	✓	✓	✓	✓	✓
	Unfinished						✓	✓	✓	✓	✓	✓	✓	✓	✓	✓	✓	✓	✓	✓	✓	✓	✓	✓	✓	✓
Penned Glaze for Stains	Amaretto Crème Charcoal Toasted Almond		✓	15%		✓	✓	✓	✓	✓	✓	✓	✓													
Paints	Black 		✓	15%	5%									✓	✓	✓	✓	✓	✓	✓	✓	✓	✓	✓		

*Heirloom upcharge is in addition to other finish upcharges. Available on Oak only, not available on Traditional FO.

▲In Standard construction, cabinets will have matching laminate ends. Where not available, ends will be Natural Maple laminate and a finished end treatment would be needed for an exposed end.

 Signed finish agreement required, see Policies section at the end of the book.

FINISH AVAILABILITY

DOOR COLOR AVAILABILITY		PURESTYLE™	SPECIALTY LAMINATE		
		Henning	Albany	Dayton	Gilmore
Non-Textured	Antler				✓
	Icy Avalanche Linea Nightfall*	✓			✓
Textured	Arctic			✓	
	Elk	✓			✓
	Gunstock*	✓			✓
	Obsidian			✓	
	Wharf				✓
High Gloss	White w/Matching Edgebanding		✓		
	White w/Metallic Edgebanding		✓		

*TEPS12102P, TEPS12108P, TEPS12120P, TEPS102P, TEPS108P, TEPS120P, LSHAKER10P, SM10P, and SSM10P are not available in Icy Avalanche Linea Nightfall and Gunstock. TEP12102P, TEP12108P, TEP24102P, and TEP24108P are not available in Gunstock.

CABINET COLOR AVAILABILITY		Matching Laminate Ends [▲]	DOOR COLOR AVAILABILITY							
			Antler	Arctic	Elk	Gunstock	High Gloss White	Icy Avalanche Linea Nightfall	Obsidian	Wharf
Stains	Boardwalk Maple	✓	✓		✓					
	Chocolate Cherry	✓				✓				
	Chocolate Maple	✓				✓				
	Chocolate Oak	✓				✓				
	Morel Cherry	✓	✓							
	Morel Maple	✓	✓							
	Morel Oak	✓	✓							
	Seal Maple	✓			✓					
	Seal Oak	✓			✓					
	Storm Maple	✓							✓	
	Thatch Cherry	✓				✓				
	Thatch Maple	✓			✓	✓				
	Thatch Oak	✓			✓	✓				
Paints	Black	✓							✓	
	Cloud	✓	✓	✓						
	Icy Avalanche	✓		✓				✓		
	White	✓	✓	✓			✓			✓

▲In Standard construction, cabinets will have matching laminate ends to match the cabinet box color.

F35

FINISH AVAILABILITY

NOTES

F36

FINISH AVAILABILITY

CONSTRUCTION FEATURES

	STANDARD CONSTRUCTION	PLYWOOD ENDS (PE)*	ALL-PLYWOOD CONSTRUCTION (APC)*
Doors & Drawer Fronts	See Door Style section for door and drawer front configuration and construction details.		
Face Frames	3/4" solid hardwood.		
I-beam Braces	3/8" furniture board dadoed into face frame, end panels and back panels.		3/8" plywood dadoed into face frame, end panels and back panels.
Cabinet Sides	1/2" furniture board with Natural Maple laminate interiors. Exteriors are laminate that match the color of the face frame where matching laminate ends are available. See Finish Availability section for matching laminate ends availability.	1/2" unfinished veneer plywood with Natural Maple laminate interiors.	
Cabinet Tops & Bottoms (Wall & Tall)	3/8" furniture board with Natural Maple laminate interior and exterior.		3/8" plywood with Natural Maple laminate interior and exterior.
Cabinet Bottoms (Base & Vanity)	3/8" furniture board with Natural Maple laminate interior.		3/8" plywood with Natural Maple laminate interior.
Cabinet Backs	3/8" furniture board with Natural Maple laminate interior. Base cabinets have 3mm system holes for easy drawer and tray installation.		3/8" plywood with Natural Maple laminate interior. Base cabinets have 3mm system holes for easy drawer and tray installation.
Adjustable Shelves	3/4" furniture board with Natural Maple laminate to match interiors. Shelves are adjustable in wall and base cabinets unless otherwise noted.		3/4" plywood with Natural Maple laminate to match interiors. Shelves are adjustable in wall and base cabinets.
Finish	Multi-step finishing process where the finished components are sanded, stained, and sealed before a catalyzed top coat is applied.		
Hinges	Fully Concealed Integrated Soft-close Self Closing, 6-way Adjustable. Hinge features deactivation option. Some cabinets utilize a 170° or 107° 4-way adjustable hinge. See page 320 for details.		
Drawer Box and Roll Tray Construction	All Styles: Four-sided clear coated hardwood. Corners are dovetailed and glued. Drawer bottom is 5.2mm laminated plywood fully captured in box sides, front and back.		
Drawer and Roll Tray Guide	Double fully concealed, roller bearing, self-aligning, full extension guide with soft-close self-closing mechanism and fast clip removal system. Soft-close engages when the drawer or roll tray is approximately 2" from closing, applying resistance to the self-closing mechanism. Optional (Roll Trays): EasyTrax™ (ET) height adjustment system. Standard guides have a maximum weight capacity of 75 lbs. Drawers and roll trays have a maximum weight capacity of 15 lbs. per square foot.		
Toekick	Unfinished furniture board toekick to allow application of finished toeboard materials. A variety of laminate and wood toeboard skins and baseboard mouldings available in 8' lengths; see ACCESSORIES section.		3/8" Unfinished plywood toekick to allow application of finished toeboard materials. Toeboard skins and baseboard mouldings available in 8' lengths; see ACCESSORIES section.
Interior Cabinet Components	A few interior components are manufactured from laminated furniture board because they provide for the most durable, aesthetic application. Some examples include the BCFW48SP (swing-out shelf), SLS33/36 (fixed shelf), and PY36 (swing-out and door mounted racks).		

STANDARD CABINET CONSTRUCTION

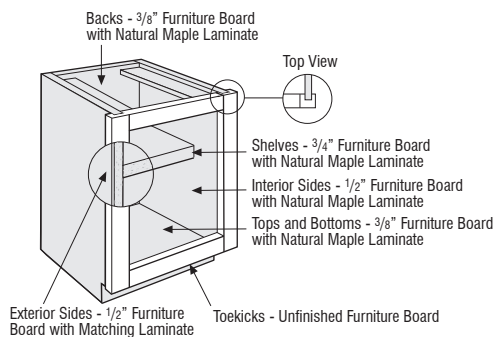

See page 3 for Plywood Ends and All-plywood Construction.

STANDARD DRAWER CONSTRUCTION

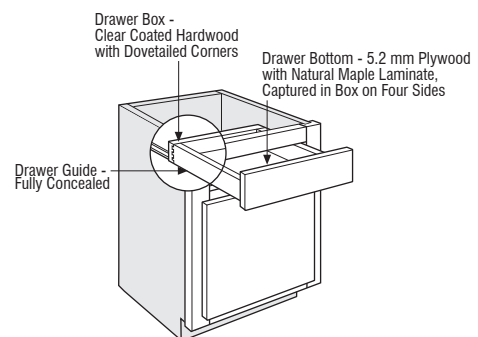

See page 3 for Plywood Ends and All-plywood Construction.

*All-plywood components meet ANSI/HPVA HP-1 standards and may contain MDF or particleboard.

CONSTRUCTION UPGRADES

See page 2 for modification compatibility.

OPTION NAME	APPLICABLE CABINET GROUP	DESCRIPTION/LIMITATIONS	PRICING
Plywood Ends (PE)*	Most cabinets with sides	Replaces standard cabinet ends with unfinished 1/2" plywood exterior ends. See page 1 for more details.	Cabinet list + 6%
All-plywood Construction (APC)*	Most cabinets with sides	Replaces standard cabinet construction with plywood for 1/2" ends, 3/4" shelves, and 3/8" top, bottom, and back. Exterior of cabinet ends are unfinished. See page 1 for more details.	Cabinet list + 12%
	Selected trim panels	Replaces standard panel material with plywood. Exterior side is finished. Interior side is Natural Maple laminate.	List + 12%

3

PLYWOOD ENDS CONSTRUCTION UPGRADE (PE)

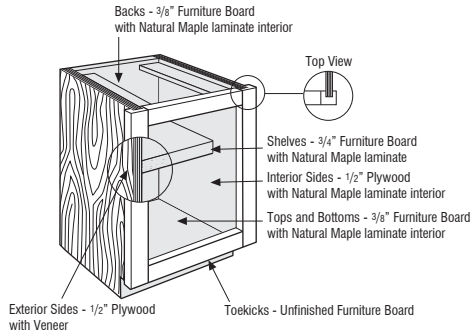

ALL-PLYWOOD CONSTRUCTION UPGRADE (APC)

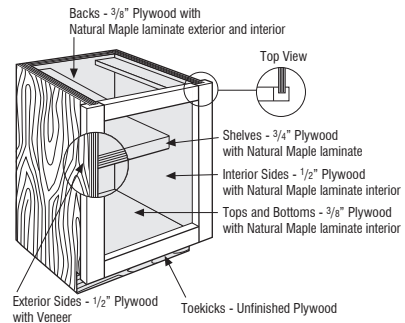

*All-plywood components meet ANSI/HPVA HP-1 standards and may contain MDF or particleboard.

THINGS TO REMEMBER ABOUT FINISHED ENDS AND CABINET INTERIOR FINISHES

On cabinets with PLYWOOD ENDS (PE) or ALL-PLYWOOD CONSTRUCTION (APC) modifications, cabinet sides are plywood with an unfinished veneer exterior. You can finish the exposed ends in your kitchen with one of several decorative options, as follows:

1. Leave the ends UNFINISHED if the cabinets are installed against each other or against the wall.
2. Purchase a 1/4" VENEER SKIN for field installation. This brings the cabinet side flush with the face frame.
3. Specify FURNITURE FINISHED PLYWOOD ENDS (FPPEB). See page 7 for details.
4. Specify AUTHENTIC ENDS (AUTHL, AUTHR, or AUTHB) or Face Frame and Door on End (FFDL or FFDR). See page 7 for details.
5. Specify cabinets with FINISHED ENDS (FB), factory installed. Both ends of the cabinet use 1/2" plywood veneer panel that is factory finished on the exterior to match the door and frame.
6. Purchase Wall, Base or Tall END DECORATIVE DOOR PANELS (WED, BED, TED). These are a skin and a door that can be attached to finish the exposed end. This will extend the total cabinet run by the thickness of the door.
7. Purchase a Wall MESSAGE CENTER.
8. Cabinets specified with MIP have matching veneer interior and exterior. Some cabinets are provided with standard MIP construction, such as:
 - Wine Rack Cabinets
 - Bookcase Cabinets
 - Base Open Cabinets
9. All Wall Organizer and Wall/Base Apothecary Drawer Cabinets are framed construction and feature 1/2" plywood with matching finished veneer interior and exterior.

DRAWER FRONT OPTIONS

See page 2 for modification compatibility.

OPTION NAME	APPLICABLE CABINET GROUP	DESCRIPTION/LIMITATIONS	PRICING
Drawer Front Flat 5-piece (DFF5PC)	Base, tall, and vanity cabinets on select door styles. See Door Style section for availability.	Replaces the standard drawer front with a 5-piece flat center panel drawer front (see images with applicable door styles). Must upgrade all drawer fronts on a cabinet where applicable. Premium finish and finish technique upcharges will apply where applicable. See Door Style section for 5-piece drawer front dimensions when specifying decorative hardware. Available as a global option and will apply to all cabinets.	\$105 list per drawer front
Drawer Front Flat 5-piece Narrow Rails (DFF5PCNR)	Base, tall, and vanity cabinets on select door styles. See Door Style section for availability.	Replaces the standard 5-piece flat center panel drawer front (2 1/4" high top and bottom rails) with a narrow rail 5-piece flat center panel drawer front (1 1/2" high top and bottom rails) (see images with applicable door styles). Premium finish and finish technique upcharges will apply where applicable. See Door Style section for 5-piece drawer front dimensions when specifying decorative hardware.	No Upcharge
Drawer Front Slab (DFS LB)	Base, tall, and vanity cabinets on select door styles. See Door Style section for availability.	Replaces the standard drawer front with a slab drawer front (see images with applicable door styles). Must upgrade all drawer fronts on a cabinet where applicable. Premium finish and finish technique upcharges will apply where applicable. Available as a global option and will apply to all cabinets.	No Upcharge

4

DRAWER FRONT OPTIONS

DRAWER FRONT OPTIONS (cont'd)

See page 2 for modification compatibility.

OPTION NAME	APPLICABLE CABINET GROUP	DESCRIPTION/LIMITATIONS	PRICING
Drawer Front Flat 5-piece with Slab Top (DFF5PCSLBT)	32" and 34 1/2" high base and vanity and tall cabinets on select door styles. See Door Style section for availability.	Replaces the standard slab drawer fronts with a 5-piece flat center panel drawer front with the exception of the top drawer front of base and vanity cabinets when the face frame opening is 5" high, which will remain slab (see images with applicable door styles). Drawer front will be slab on Tall Built-in Microwave (TBMWB., T3DMW.), Single Oven Cabinets (OSB., OS3D.), and Linen Tall Cabinets (LTD. and L188421BH). See below for DFF5PCSLBT location availability. Not compatible with Inverted Frame (INVFRM) modification. Must upgrade all drawer fronts on a cabinet where applicable. Upcharge for 5-piece drawer front is not applied to slab drawer fronts. Premium finish and finish technique upcharges will apply where applicable. See Door Style section for 5-piece drawer front dimensions when specifying decorative hardware.	\$105 list per 5-piece drawer front
Drawer Front Flat 5-piece Narrow Rails with Slab Top (DFF5PCNRST)	32" and 34 1/2" high base and vanity and tall cabinets on select door styles. See Door Style section for availability.	Replaces the standard 5-piece flat center panel drawer front (2 1/4" high top and bottom rails) with a narrow rail 5-piece flat center panel drawer front (1 1/2" high top and bottom rails) with the exception of the top drawer front of base and vanity cabinets when the face frame opening is 5" high, which will be slab (see images with applicable door styles). Drawer front will be slab on Tall Built-in Microwave (TBMWB., T3DMW.), Single Oven Cabinets (OSB., OS3D.), and Linen Tall Cabinets (LTD. and L188421BH). See below for DFF5PCNRST location availability. Not compatible with Inverted Frame (INVFRM) modification. Upcharge for 5-piece drawer front is not applied to slab drawer fronts. Premium finish and finish technique upcharges will apply where applicable. See Door Style section for 5-piece drawer front dimensions when specifying decorative hardware.	No Upcharge
Drawer Front Slab Top (DFSLBT)	32" and 34 1/2" high base and vanity and tall cabinets on select door styles. See Door Style section for availability.	Replaces the 5-piece top drawer front of base and vanity cabinets with a slab drawer front when the face frame opening is 5" high. The remaining drawer fronts will remain 5-piece (see images with applicable door styles). Drawer front will be slab on Tall Built-in Microwave (TBMWB., T3DMW.), Single Oven Cabinets (OSB., OS3D.), and Linen Tall Cabinets (LTD. and L188421BH). See below for DFSLBT location availability. Not compatible with Inverted Frame (INVFRM) modification. Must upgrade all drawer fronts on a cabinet where applicable. Premium finish and finish technique upcharges will apply where applicable. See Door Style section for 5-piece drawer front dimensions when specifying decorative hardware.	No Upcharge

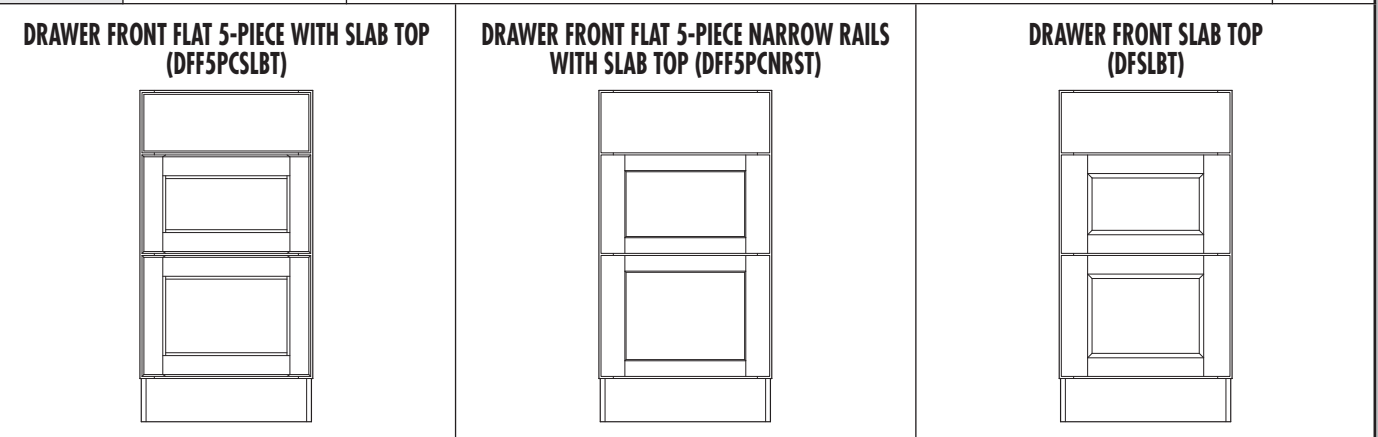

5

DRAWER FRONT OPTIONS

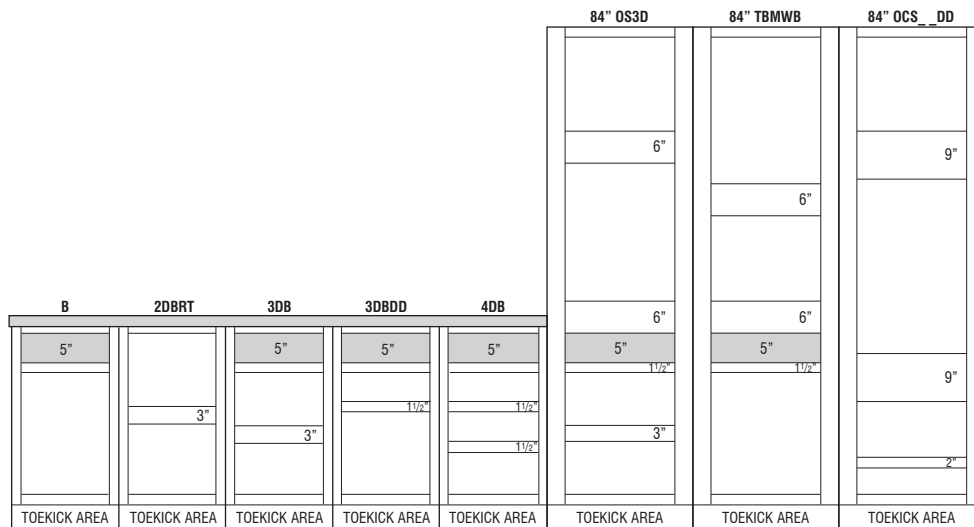

DFF5PCSLBT, DFF5PCNRST, and DFSLBT location availability indicated by gray shading. Vanity combo units utilize base cabinet location availability.

DOOR OPTIONS

See page 2 for modification compatibility.

OPTION NAME	APPLICABLE CABINET GROUP	DESCRIPTION/LIMITATIONS	PRICING
Door Panel - Solid Reverse Raised (DPSRR)	Most cabinets with doors and most panels with doors; AUTHL, AUTHR, AUTHB, FFDL, and FFDR modifications; available on select door styles. See Door Style section for availability.	Available on Full Overlay door styles only. Replaces veneer flat door center panel with a solid reverse raised center panel. Drawer fronts are not affected by this door option. When ordered in Maple, center panels in Paint and Paint with Glaze finishes will be reverse raised MDF.	\$84 list per door
Modified Full Overlay (MFO)	Most wall and tall cabinets and some panels with doors	Reduces the size of a Full Overlay door by 3/4" allowing for a top face frame reveal of 1" to allow for face mount moulding application. Overlay Fillers are available in MFO heights to align with doors, see pages 257-260 for OL..MFO and OL..MFOP. Not compatible with Add Toekick modification. When Authentic End(s) are ordered in conjunction with Modified Full Overlay, the Authentic End will match the face frame reveal. Not available on Aluminum Frame Doors. Available on Full Overlay door styles only. See Door Style section for other exceptions.	No Upcharge

DOOR PANEL - SOLID REVERSE RAISED (DPSRR)

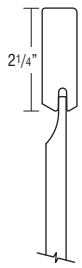

Example

MODIFIED FULL OVERLAY (MFO)

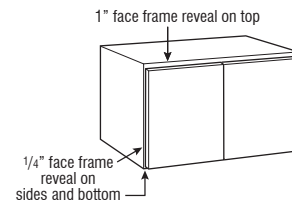

END PANEL MODIFICATIONS

See page 2 for modification compatibility.

OPTION NAME	APPLICABLE CABINET GROUP	DESCRIPTION/LIMITATIONS	PRICING
Authentic Ends (AUTHL) (AUTHR) (AUTHB)	Most wall, base, tall, and vanity cabinets	<p>Modifies cabinet end panel(s) with applied decorative door(s) onto FPEB upgraded end panel(s). Includes FPEB modification — If AUTHL or AUTHR upgrades are specified, the opposite end panel is also FPEB.</p> <p>Available on most cabinets with depths of 9", 12", 15", 18", 21", 24" and 27". Custom doors must be specified for other depths not listed. 9" depth available on cabinets 30" high or taller.</p> <p>Tall mitered door styles and laminate door styles will feature one center panel, other door styles will feature two center panels.</p> <p>27" deep cabinets will have double door configuration. Office base cabinets (29" high) will have double door configuration when specified on 24" deep cabinets.</p> <p>DPSRR option and upcharge applies to Authentic End door(s), which will be upgraded to a solid reverse raised center panel.</p>	<p>AUTHL/AUTHR Wall: \$390 list per side Base & Vanity: \$553 list per side Tall: \$1,321 list per side</p> <p>AUTHB Wall: \$780 list Base & Vanity: \$1,106 list Tall: \$2,642 list</p>
Face Frame and Door on End (FFDL) (FFDR)	Most wall, base, tall, and vanity cabinets	<p>Creates a working door on the end of the specified cabinet. Side cabinet configuration will match front cabinet configuration (i.e. drawer/door or full height door). Opposite end panel will be FPEB.</p> <p>On Base and Tall cabinets, recessed toe space is standard on the side specified with FFDR or FFDL (if any flush toekick modification is specified, FFD side of cabinet will also be flush). 12" deep cabinets specified with FFDL or FFDR and FTKAV or FTKFV will receive a standard flush toekick.</p> <p>Full depth shelves standard. Glass shelves not compatible with the FFD modification.</p> <p>Doors will always be hinged on the back of the cabinet. Option not available on both ends of cabinet. Not available on peninsula cabinets. Available on cabinets in depths of 12", 15", 18", 21", and 24".</p> <p>CG, MD, and DPSRR options and upcharges apply to FFD door. When MD is selected on 12" deep cabinets, the FFD door will be CG. When ordered with Mullion Doors, adjustable shelves may not align with mullions.</p>	<p>Wall: \$390 list Base & Vanity: \$553 list Tall: \$1,321 list</p>
Finished Ends (FB)	Cabinets with PE or APC modification; both ends will be finished	Creates a matching finished 1/2" veneer plywood exterior.	<p>Wall: \$78 list Base: \$127 list Tall: \$321 list</p>
Furniture Finished Plywood* Ends (FPEB)	Most wall, base, tall, office, and vanity cabinets	Replaces standard cabinet ends with 3/4" finished veneer end panels to achieve a Furniture End appearance. Both exterior sides are finished. Matching interior (MIP) is available.	<p>Wall: \$157 list Base & Vanity: \$227 list Tall: \$406 list</p>

AUTHENTIC ENDS (AUTHL/AUTHR/AUTHB)

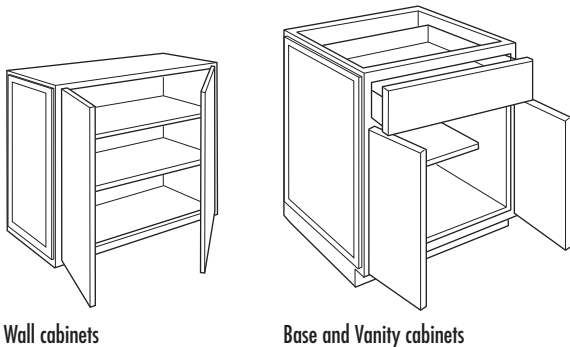

Wall cabinets

Base and Vanity cabinets

FURNITURE FINISHED PLYWOOD ENDS (FPEB)

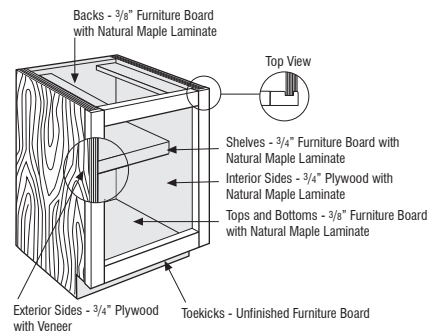

FACE FRAME AND DOOR ON END (FFDL/FFDR)

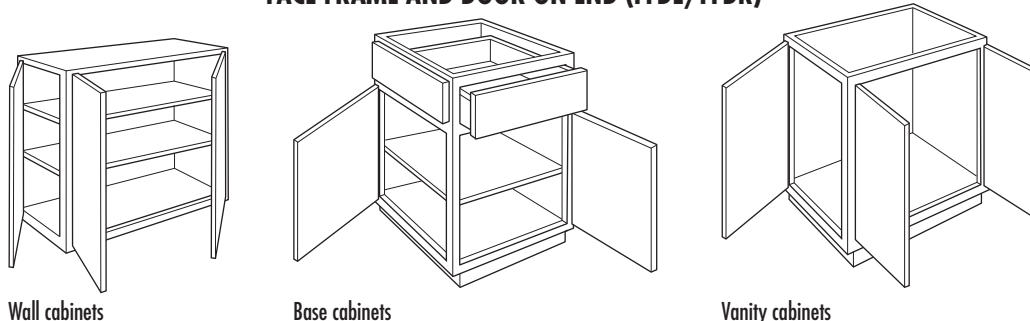

Wall cabinets

Base cabinets

Vanity cabinets



*All-plywood components meet ANSI/HPVA HP-1 standards and may contain MDF or particleboard.

FINISH MODIFICATIONS

See page 2 for modification compatibility.

OPTION NAME	APPLICABLE CABINET GROUP	DESCRIPTION/LIMITATIONS	PRICING
Matching Interior Plywood (MIP)	Most cabinets	<p>Modifies the cabinet interior and end panel exterior to matching finished veneer plywood. Cabinet top and bottom exterior on wall cabinets is also matching finished veneer plywood.</p> <p>Cabinet construction features 1/2" plywood ends and 3/8" top, bottom, and back. Shelves are upgraded to full depth 3/4" veneered plywood.</p> <p>Interior wood accessories feature a natural finish and will not match cabinet exterior.</p> <p>When a decorative door option is chosen in 20/20, Matching Interior Plywood (MIP) is a preselected option. If MIP is not desired, it can be deselected by choosing NOTMIP.</p>	Cabinet list + 25%
	Most end panels with fillers attached	Replaces standard panel material with veneer plywood finished on both sides.	List + 25%

MATCHING INTERIOR PLYWOOD (MIP)

-  matching finished veneer
-  standard matching finished component
-  standard non-matching finished component

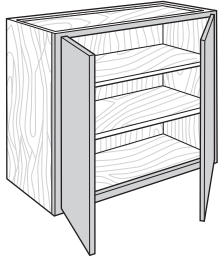

Wall cabinets

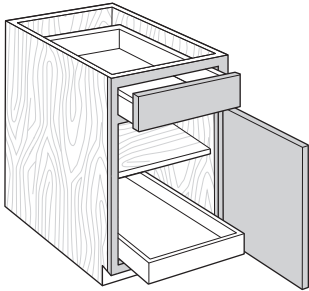

Base cabinets

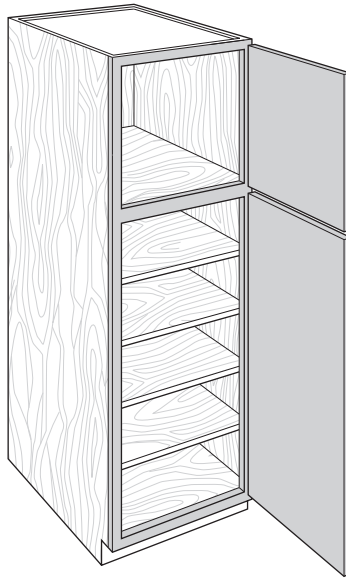

Tall cabinets

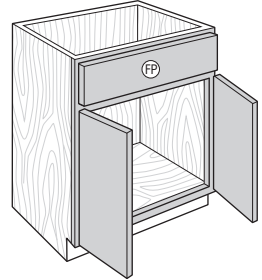

Vanity cabinets

BOX MODIFICATIONS

See page 2 for modification compatibility.

OPTION NAME	APPLICABLE CABINET GROUP	DESCRIPTION/LIMITATIONS	PRICING
Cabinet Box Only (CBO)	Most wall, base, tall, and vanity cabinets	Removes doors, drawer fronts, and any accessory items attached to a door or drawer front. Drawer box and any interior components attached to the cabinet box will be included. Frames will not be drilled for hinges, but cabinet will have standard drilling for shelves and guides.	Wall & Tall: 85% of cabinet list Base & Vanity: 90% of cabinet list
Cabinet Case Only (CCO)	Most wall, base, tall, and vanity cabinets	Removes doors, drawer fronts, drawer boxes, interior components, and mini touch-up kits. Frames will not be drilled for hinges, but cabinet will have standard drilling for shelves and guides.	85% of cabinet list
Cabinet False Panel (CFP)	Most base and vanity cabinets with a top drawer	Replaces top drawer with false panel. Not available with deep drawers.	No Upcharge
Cabinet with No Door, with Drawer (CND)	Most wall, base, tall, and vanity cabinets with door(s) and drawer(s)	Removes door(s). Complete drawer(s) with drawer front(s) and interior components remain in cabinet. Frames will not be drilled for hinges.	90% of cabinet list

CABINET BOX ONLY (CBO)

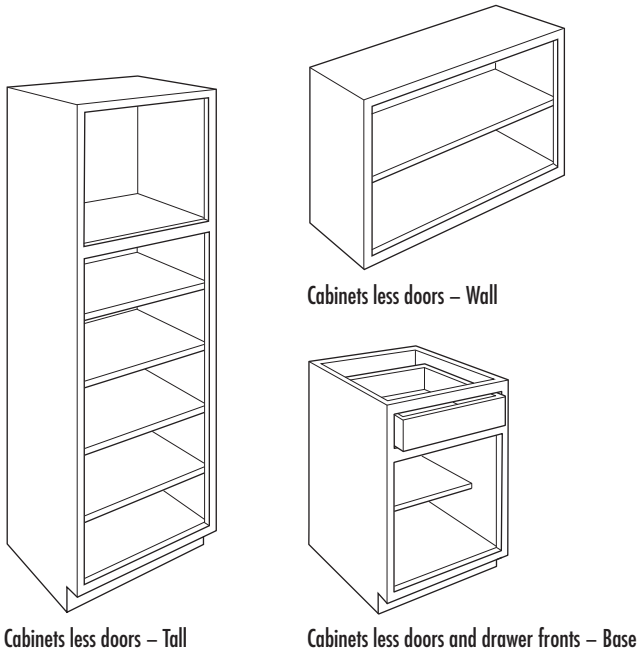

CABINET CASE ONLY (CCO)

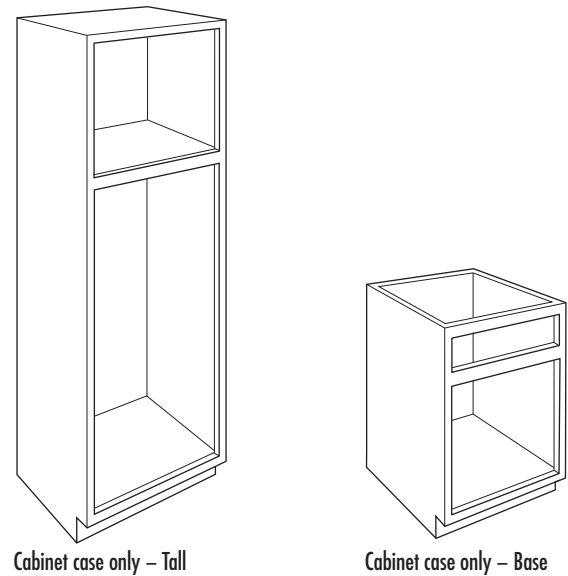

CABINET FALSE PANEL (CFP)

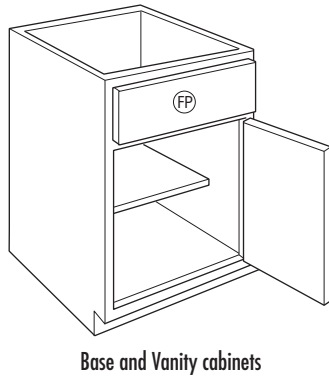

CABINET WITH NO DOOR, WITH DRAWER (CND)

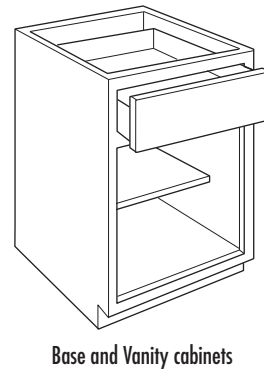

BOX MODIFICATIONS (cont'd)

See page 2 for modification compatibility.

OPTION NAME	APPLICABLE CABINET GROUP	DESCRIPTION/LIMITATIONS	PRICING
Custom Height (CH)	Most cabinets	<p>Reduces cabinet height in 1/4" increments. Select the cabinet with the next largest size available and specify the desired height, i.e. W3042 CH39.75.</p> <p>The number of doors, drawer fronts, and drawers does not change when the cabinet height is reduced. The number of shelves typically does not change unless the frame height is reduced to less than 23 1/2" and then a shelf will not be included.</p> <p>Minimum Height varies by cabinet type: Wall cabinets: Minimum height is generally determined by the smallest available height in the same cabinet configuration Base and Vanity (32" and 34 1/2" high): 27 1/2" minimum height Base (40 1/2" high): 34 3/4" minimum height Country Sink Base and Drop-in Range: 32" minimum height (top panel height remains the same) Utility: 66" high minimum height is 46 3/4", 84" high minimum height is 78". Utility Organizer Cabinet (UOC, UOC..DZ): 73 1/2" minimum height Pantry Top Unit with Shelves (PTUS): 42" minimum height Wall Bookcases (W..BC): 24" minimum height Wall Furniture Bookcases (WFBC): 42" minimum height Tall Bookcases: 69 1/4" minimum height Linen Tall (aligns with 32" high vanity): 68 1/4" minimum height Linen Tall (aligns with 34 1/2" high vanity): 70 3/4" minimum height</p> <p>Height is reduced from different cabinet sections depending on the cabinet configuration: Stacked Wall (STW, STWC, STDW) and Diagonal Wall with Lower Doors (DW..D): Height reduction is in the larger section (smaller section stays equivalent to an 18" high cabinet) Wall Microwave Cabinets with Doors (MW, WBMW, and WMW): Height reduction is in the upper section (lower section does not change) Base Cabinets: Height reduction is in the door section. Utility Cabinets (U, U..RT): Height reduction is in the upper section (lower section remains equivalent to 66" high) Oven Cabinets (OSB, OS3D, OCS, OCD, TBMWB, T3DMW, and OMC): Height reduction is in the upper section (lower section and cut-out area do not change) Wall Furniture Bookcases (WFBC): Height reduction is in the larger section. Tall Bookcases (TBC): Height reduction is in the larger section. Linen Tall: Height reduction is from upper section</p> <p>Not available on all door styles. See Door Style section for exceptions. Available on most cabinets with standard roll trays or specified with Roll Tray (RT) modification. Not available on cabinets with interior accessories such as tray dividers, cutlery inserts, lazy susans, wastebaskets, pull-outs, or door racks. Not available on Universal Access cabinets or Vanity cabinets with both sink openings and drawers. Not available on Overlay Fillers. Cut-for-glass (CG) is available, but Mullion Doors (MD) and glass inserts are not available in custom heights. For other modification compatibility, see page 2 for Modification/Upgrade Compatibility Chart.</p>	No Upcharge
	Shelf kits and roll tray kits	<p>Reduces shelf or roll tray width in 1/4" increments. Minimum width is determined by the smallest shelf or roll tray kit available width in the same configuration. Select the kit with the next largest size available and specify the desired applicable cabinet width, i.e. RT18 CW17.25.</p> <p>Not available on Glass Shelf Kits (GSK).</p>	No Upcharge
Custom Width (CW)	Most cabinets	<p>Reduces cabinet width in 1/4" increments. Minimum width is generally determined by the smallest available width in the same cabinet configuration. Select the cabinet with the next largest size available and specify the desired width, i.e. W3042 CW28.25.</p> <p>The number of doors, drawer fronts, and drawers does not change when the cabinet width is reduced.</p> <p>Not available on all door styles. See Door Style section for exceptions. Not available on cabinets with 4 door wide configurations. Available on most cabinets with standard roll trays or specified with Roll Tray (RT) modification. Not available on cabinets with interior accessories such as tray dividers, cutlery inserts, lazy susans, wastebaskets, pull-outs, or door racks. Cut-for-glass (CG) is available, but Mullion Doors (MD) and glass inserts are not available in custom widths. For other modification compatibility, see page 2 for Modification/Upgrade Compatibility Chart.</p>	No Upcharge
	Shelf kits and roll tray kits	<p>Reduces shelf or roll tray width in 1/4" increments. Minimum width is determined by the smallest shelf or roll tray kit available width in the same configuration. Select the kit with the next largest size available and specify the desired applicable cabinet width, i.e. RT18 CW17.25.</p> <p>Not available on Glass Shelf Kits (GSK).</p>	No Upcharge

CUSTOM HEIGHT (CH)

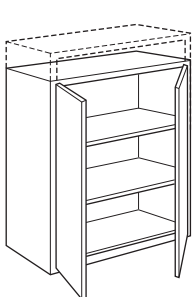

Wall cabinets

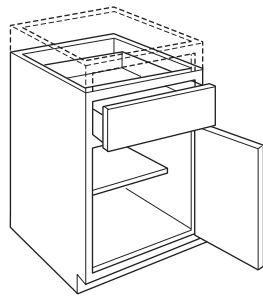

Base cabinets

CUSTOM WIDTH (CW)

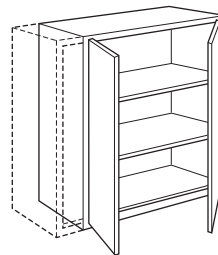

Wall cabinets

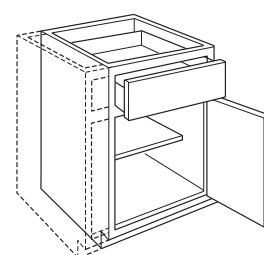

Base cabinets

BOX MODIFICATIONS (cont'd)

See page 2 for modification compatibility.

OPTION NAME	APPLICABLE CABINET GROUP	DESCRIPTION/LIMITATIONS	PRICING
Increased Depth (ID)	Most wall and vanity cabinets	Increases the depth of wall and vanity cabinets in 1" increments to a maximum depth of 24". On 24" deep wall models, ID25-ID27 is available. APC is required. Increased depth wall cabinets should be either floor mounted or stacked to maintain stability. Any specified shelving is included and is always full depth. Wall peninsula cabinets may be increased in 1" increments to 18" maximum. Drawer depth will not change. Depth restrictions may apply where depths are available as a standard cabinet. Wall cabinets 12" deep are limited to up to 15" deep on sizes where a 24" deep cabinet is available.	No Upcharge
	Most base, tall, and vanity cabinets without drawers or roll trays	Increases the depth of base, tall, and vanity cabinets without drawers or roll trays in 1" increments to 27". When depth beyond 24" is desired, the 24" deep cabinet must be modified. Any specified shelving is included and is always full depth. Depth restrictions may apply where depths are available as a standard cabinet.	No Upcharge
	Oven Cabinets with only one bottom drawer	Increases the depth of oven cabinets in 1" increments to a maximum depth of 27". When the depth of an oven cabinet with a drawer is increased, drawer depth will not change. Any specified shelving is included and is always full depth.	No Upcharge
	End panels	Increases the depth of end panels in 1" increments to a maximum depth of 36". 31"-36" depths available on plywood panels only. AEL/AER panels are only available in 3" increments up to a maximum depth of 36".	No Upcharge
Reduced Depth (RD)	Most base, tall, and vanity cabinets with drawers or roll trays	Reduces the depth in 1" increments to a minimum depth of 12". Any specified shelving is included and is always full depth. The dimension is specified as the distance from the front of the face frame to the back of the cabinet. Vanities will be reduced to 18" at no charge.	No Upcharge
	Most base, tall, and vanity cabinets without drawers or roll trays	Reduces the depth in 1" increments to a minimum depth of 6". If reduced depth is less than 9", toekick will not be included. Any specified shelving is included and is always full depth. The dimension is specified as the distance from the front of the face frame to the back of the cabinet. Vanities will be reduced to 18" at no charge.	No Upcharge
	Most wall cabinets	Reduces the depth in 1" increments to a minimum depth of 6". Any specified shelving is included and is always full depth. The dimension is specified as the distance from the front of the face frame to the back of the cabinet. Wall top hinge cabinets can only be reduced to 9" depth minimum.	No Upcharge
	End panels	Reduces the depth in 1" increments to a minimum depth of 6".	No Upcharge
	Roll tray kits	Reduces the depth in 1" increments to fit a minimum cabinet depth of 12".	No Upcharge

Cabinet Depth	Drawer Box and Roll Tray Exterior Depth		Clearance Behind Drawer Box or Roll Tray and Back Panel	
	Standard Drawer Guides	Heavy Duty Side-mount Guides (DDFD)	Standard Drawer Guides	Heavy Duty Side-mount Guides (DDFD)
24	21	21	2 3/4	2 3/4
23	21	18	1 3/4	4 3/4
22	18	18	3 3/4	3 3/4
21	18	18	2 3/4	2 3/4
20	18	N/A	1 3/4	N/A
19	15	N/A	3 3/4	N/A
18	15	N/A	2 3/4	N/A
17	15	N/A	1 3/4	N/A
16	12	N/A	3 3/4	N/A
15	12	N/A	2 3/4	N/A
14	12	N/A	1 3/4	N/A
13	9	N/A	3 3/4	N/A
12	9	N/A	2 3/4	N/A

INCREASED DEPTH (ID)

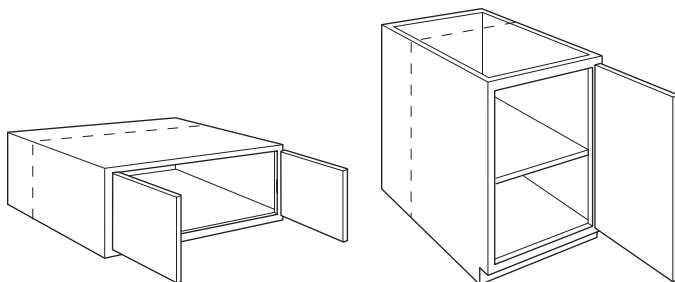

Wall cabinets

Base cabinets

REDUCED DEPTH (RD)

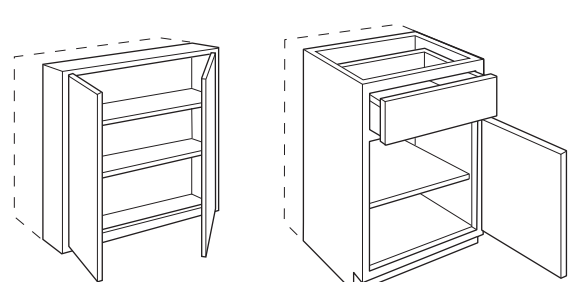

Wall cabinets

Base cabinets

BOX MODIFICATIONS (cont'd)

See page 2 for modification compatibility.

OPTION NAME	APPLICABLE CABINET GROUP	DESCRIPTION/LIMITATIONS	PRICING
End Extended Back (EXBKL) (EXBKR)	Most cabinets	<p>Extends cabinet end panel back in 1" increments, available up to 6" per side. Includes FPEB modification with 3/4" finished veneer end panels on both ends.</p> <p>EXBKL and EXBKR are compatible with each other and can be specified with either the same dimension per side or unique dimensions if desired. Compatible with Authentic Ends when End Extended Back is specified in 3" increments.</p>	<p>Wall: Cabinet list + \$169 Base: Cabinet list + \$238 Tall: Cabinet list + \$426</p>
Prepare Cabinet for Finished Bottom (PFINBTMB)	Most wall cabinets	<p>Prepares cabinet for installation of a separately purchased and field installed applied 1/4" end panel skin to create a flush finished bottom on a single cabinet or multiple cabinets that are bridged between taller adjacent cabinets.</p> <p>Features factory installed spacer blocks against the cabinet bottom, along the face frame, back, and end panels. Cabinet back and end panel heights are 1/4" less than the face frame, leaving clearance for the applied skin. Cabinet end panel bottom edge remains unfinished.</p> <p>Panel utilized for flush bottom must be purchased separately using 1/4" end panel skins (see WEPS__, TEPS__, or BEPS__ on pages 263-264) or 1/4" custom panels (see DAPNLI/4 on page 274), and requires cabinet installer to cut to size before installation.</p> <p>If used on the end of a run, moulding or a full height end panel skin must be purchased separately to cover exposed unfinished edge of applied skin for the flush finished bottom. Not compatible with FPEB, AUTHL/AUTHR/AUTHB, FFDL/FFDR, and EXBKL/EXBKR modifications.</p>	Cabinet list + \$157

END EXTENDED BACK LEFT (EXBKL)

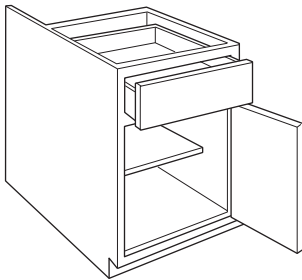

END EXTENDED BACK RIGHT (EXBKR)

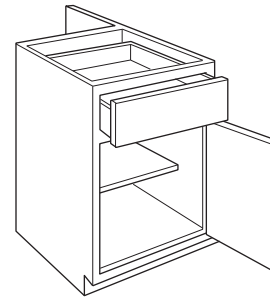

PREPARE CABINET FOR FINISHED BOTTOM (PFINBTMB)

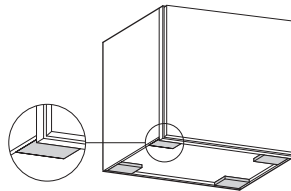

FACE FRAME MODIFICATIONS

See page 2 for modification compatibility.

OPTION NAME	APPLICABLE CABINET GROUP	DESCRIPTION/LIMITATIONS	PRICING
Appliance Cut-out, Single (ACS)	Most Oven Cabinets	<p>Creates a custom cut-out area for field-ready oven installation. Available on oven cabinets specified with an (N) for Narrow Stile, with 1 1/2" wide frame side stiles. See cabinet specifications for available cut-out dimensions.</p> <p>Custom Width dimension available in 1/4" increments, with a minimum of 3" to a maximum of 6" less than the cabinet width. Frame side stiles will not be notched.</p> <p>Custom Height dimension available in 1/4" increments. Cut-out area will be centered.</p>	Cabinet list + \$123
Extended Stile (EXL) (EXR)	Most cabinets with a face frame	<p>Extends face frame width beyond its normal width by specified dimension to eliminate the need for field installed fillers, available in 1/2" increments from 1/2"-3". For example, a 1 1/2" wide face frame with EXL2 will have a width of 3 1/2" on the left side of the cabinet.</p> <p>Extended Left: EXL.5, EXL1, EXL1.5, EXL2, EXL2.5, EXL3 Extended Right: EXR.5, EXR1, EXR1.5, EXR2, EXR2.5, EXR3</p> <p>EXL and EXR are compatible with each other and can be specified with either the same dimension per side or unique dimensions if desired. When ordered with Peninsula (P) modification, both face frames on specified side will be modified.</p>	No Upcharge

APPLIANCE CUT-OUT, SINGLE (ACS)

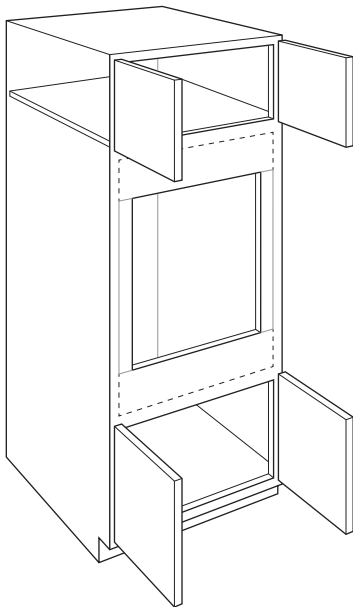

EXTENDED STILE LEFT (EXL)

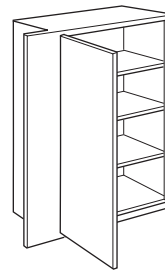

Cabinets with a face frame – Wall

EXTENDED STILE RIGHT (EXR)

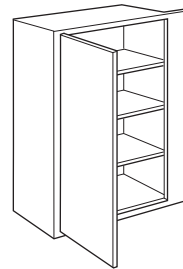

Cabinets with a face frame – Wall

FACE FRAME MODIFICATIONS (cont'd)

See page 2 for modification compatibility.

OPTION NAME	APPLICABLE CABINET GROUP	DESCRIPTION/LIMITATIONS	PRICING
Inverted Frame (INVFRM)	Most cabinets with a face frame cross rail Tall Panels with Filler Attached and Authentic Ends	Inverts face frame openings. Drawer openings relocated to the bottom of a base cabinet must always be a working drawer. Opening sizes for doors do not change, standard drawer opening changes to 4 1/2" high. Doors on inverted frame cabinets may not align with adjacent cabinet doors. On Tall Panels with Filler Attached and Authentic Ends, when INVFRM is selected, doors will be inverted (no face frame) to align with tall cabinets with the modification.	No Upcharge
Valance Top Rail (TVRAV) (TVRFV) (TVRVV)	Base Open Cabinets, Bookcases	Modifies the top rail with an arch, furniture, or straight valance.	No Upcharge

INVERTED FRAME (INVFRM)

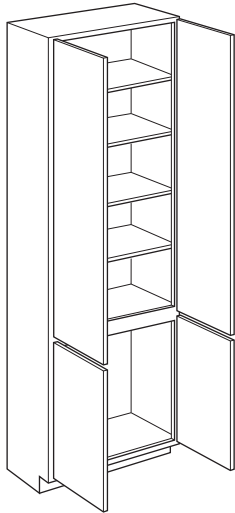

Tall cabinets

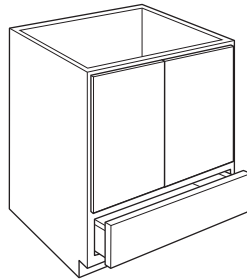

Base cabinets

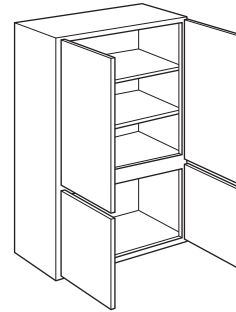

Wall cabinets

VALANCE TOP RAIL, ARCH (TVRAV)

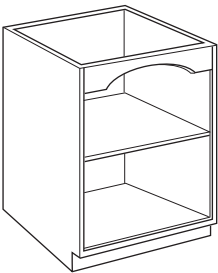

VALANCE TOP RAIL, FURNITURE (TVRFV)

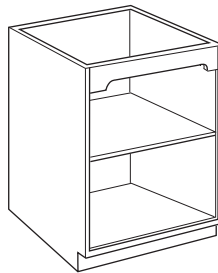

VALANCE TOP RAIL, STRAIGHT (TVRVV)

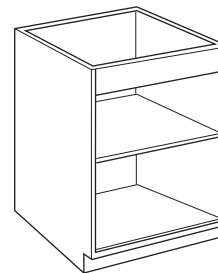

INTERIOR MODIFICATIONS

See page 2 for modification compatibility.

OPTION NAME	APPLICABLE CABINET GROUP	DESCRIPTION/LIMITATIONS	PRICING
Secured Drawer featuring Biometric Technology (DRWSEC) (DRWSECB) (DRWSECL) (DRWSECR)	Most base cabinets with a top drawer	Modifies the standard drawer box with an installed self-locking mechanism featuring proven advanced sensor biometric technology. When activated, drawer opens 2 3/16" to access fingerprint reader, which stores up to 100 unique fingerprints. Homeowner must reset memory after cabinet installation. Secured housing protrudes 2 3/4" into the depth of the drawer box interior. Features one 9V battery compartment (battery not included). Self-locking when in closed position. Manual key lock on bottom of drawer for backup method of entry. DRWSEC available on 24" deep base cabinets with widths of 18", 21", and 24". DRWSECL, DRWSECR, and DRWSECB available on 24" deep cabinets including 36" Base Buffet Cabinets and base cabinets with widths of 42" and 48". Not compatible with Reduced Depth (RD) modification or PowerGlide™ Compact Drawer Outlet (DRWPWR). Installer must remove the drawer front to drill and countersink the back of the drawer front for field installation of knobs and pulls.	DRWSEC: Cabinet list + \$590 DRWSECB: Cabinet list + \$1,180 DRWSECL: Cabinet list + \$590 DRWSECR: Cabinet list + \$590
CabMat™ (CMAT1) (CMAT2)	Most sink base and vanity cabinets	Installs removable CabMat™, size is determined by face frame opening width and cabinet depth. CMAT2 is only available on vanity cabinets designed for double bowl applications. Not available with Reduced Depth modification. When ordered with Increased Depth modification, CabMat™ size does not change. Vanity cabinets with face frame openings of 24" and 30" will utilize CabMat™ sized for 21" and 27" openings. See page 311 for CabMat™ product descriptions.	CMAT1: Cabinet list + \$284 CMAT2: Cabinet list + \$568
Full Depth Shelf (FD)	Base cabinets with standard half depth shelves	Replaces standard shelf with full depth shelf.	Cabinet list + \$59

SECURED DRAWER FEATURING BIOMETRIC TECHNOLOGY (DRWSEC/DRWSECB/DRWSECL/DRWSECR)

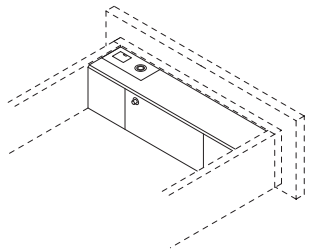

FULL DEPTH SHELF (FD)

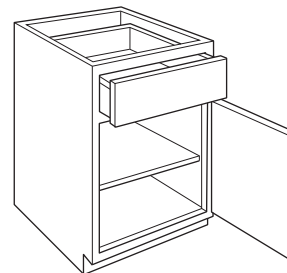

CABMAT™ (CMAT1/CMAT2)

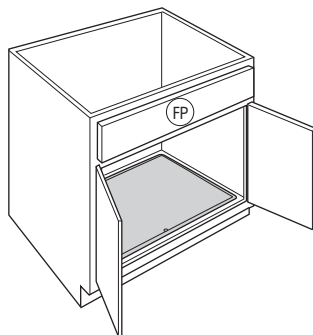

Base cabinets (CMAT1)

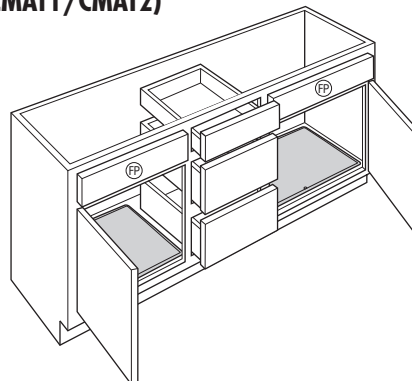

Vanity cabinets with double bowl (CMAT2)

INTERIOR MODIFICATIONS (cont'd)

See page 2 for modification compatibility.

OPTION NAME	APPLICABLE CABINET GROUP	DESCRIPTION/LIMITATIONS	PRICING
Deep Roll Tray (DRT)	Most cabinets with roll trays	Replaces standard roll trays with a 6 3/8" deep roll tray. Replaces bottom roll tray only on base cabinets and bottom 2 roll trays on utility cabinets.	Base: Cabinet list + \$102 Tall: Cabinet list + \$204
Installed Roll Tray (RT)	Select base, tall, office, and vanity cabinets	<p>Installs specified number of roll trays (1-5 per side). Example, for two roll trays, specify 2RT.</p> <p>On cabinets with center stile, specify RTL for roll trays in left side and RTR for roll trays in right side. Both RTL and RTR should be selected for roll trays in both sides.</p> <p>When 1RT is specified on a base cabinet, the roll tray is installed in the lowest position and one half depth adjustable shelf is included. On utility cabinets for lower section, 1RT includes three shelves, 2RT includes two shelves, and 3RT includes 1 shelf. No shelves for lower section are included with 4RT or 5RT.</p> <p>See page 38 for RT positions.</p>	1RT: Cabinet list + \$284 2RT: Cabinet list + \$568 3RT: Cabinet list + \$852 4RT: Cabinet list + \$1,136 5RT: Cabinet list + \$1,420
EasyTrax™ (ET)	Most cabinets with roll trays	Includes pre-installed upright wooden system that allows for easy height adjustment of roll trays.	Base: Cabinet list + \$209 Tall: Cabinet list + \$367
Scooped Drawer (SCPDRW) (SCPDRWB) (SCPDRWL) (SCPDRWR)	Most base cabinets with a drawer	<p>Replaces top drawer box with a 2" high drawer box to allow for clearance of cooktops, etc. Only top drawer will be modified when specified on drawer bases.</p> <p>On base cabinets with two top drawers, L, R, or B must be specified.</p> <p>Increases clearance for cooktops from 2 1/2" to 3 7/8".</p> <p>When SCPDRW is selected on 2DB18-2DB42, top drawer will utilize a 6 3/8" high drawer box, creating a clearance of 6 5/8" for the cooktop.</p> <p>Not available on certain door styles. See Door Style section for availability.</p>	SCPDRW: Cabinet list + \$68 SCPDRWB: Cabinet list + \$136 SCPDRWL: Cabinet list + \$68 SCPDRWR: Cabinet list + \$68

DEEP ROLL TRAY (DRT)

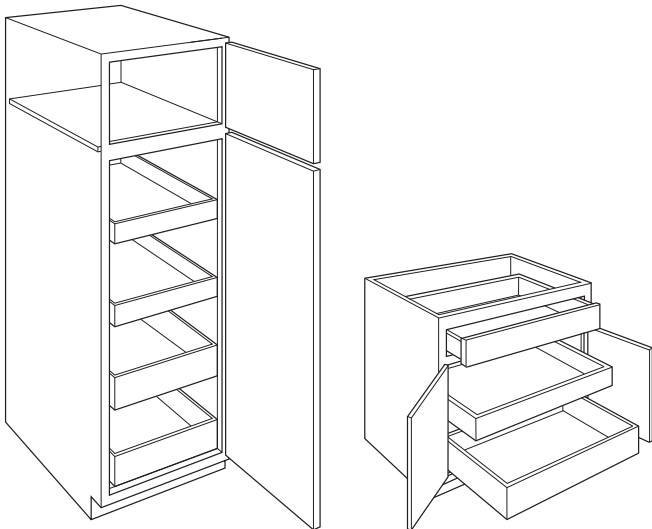

Tall cabinets

Base cabinets

INSTALLED ROLL TRAY (RT)

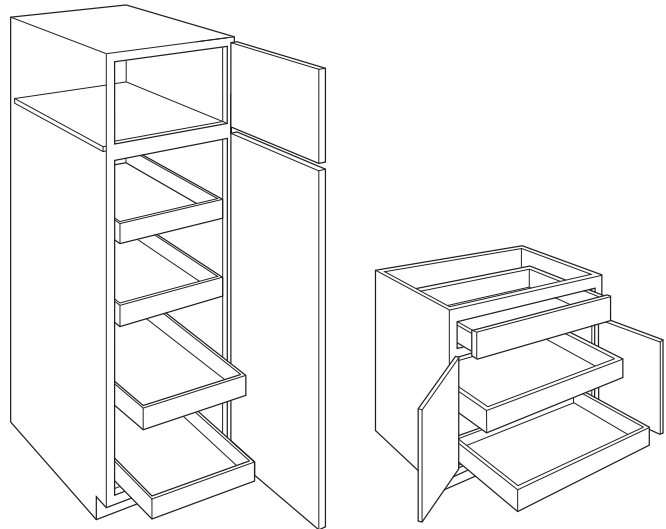

Tall cabinets

Base, Office, and Vanity cabinets

EASYTRAX™ (ET)

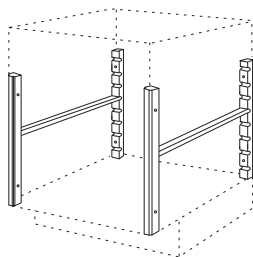

SCOOPED DRAWER (SCPDRW/SCPDRWB/SCPDRWL/SCPDRWR)

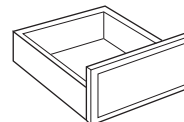

INTERIOR MODIFICATIONS (cont'd)

See page 2 for modification compatibility.

OPTION NAME	APPLICABLE CABINET GROUP	DESCRIPTION/LIMITATIONS	PRICING
PowerGlide™ Compact Drawer Outlet (DRWPWR) (DRWPWRB) (DRWPWRL) (DRWPWRR)	Most base cabinets with a top drawer	Installs PowerGlide™ Compact Drawer Outlet into the drawer box. Includes two 120V electrical plug-ins and two 2.1 amp rated USB charging ports with a total rated capacity of 15 amps. Cord has 3 ft. of length hanging freely from back mounting bracket. The cord is 14 gauge wire and features a standard 3-prong plug and is required to be plugged into an approved GFCI outlet for all applications. Outlet is ETL approved-compliant for electrical and other safety standards to U.S. and Canadian safety including UL standards. Outlet face plate measures 5.22" x 2.3" and will extend 3/4" into drawer box. Available on base cabinet widths of 18"-36". For use in cabinet depths of 15", 18", 21", and 24". Only compatible with RD in 3" increments. Also available as a field installed accessory, see DRWPWR1 on page 314.	DRWPWR: Cabinet list + \$480 DRWPWRB: Cabinet list + \$960 DRWPWRL: Cabinet list + \$480 DRWPWRR: Cabinet list + \$480
Push to Open Wastebasket (PTOWB)	Base cabinets with door mounted wastebasket pull-outs	Changes the guide mechanism on wastebasket pull-outs to a mechanical push to open guide with soft-close. Available on 24" deep cabinets only. Does not change other drawer guides on the cabinet.	Cabinet list + \$421
Tilt-out Tray, Stainless Steel Slim (TOTSSS)	Cabinets with false panels	Installs one stainless steel tilt-out tray inside of each false panel. Tray is 1 11/16" deep and protrudes 3/4" into cabinet.	Cabinet list + \$273

POWERGLIDE™ COMPACT DRAWER OUTLET (DRWPWR/DRWPWRB/DRWPWRL/DRWPWRR)

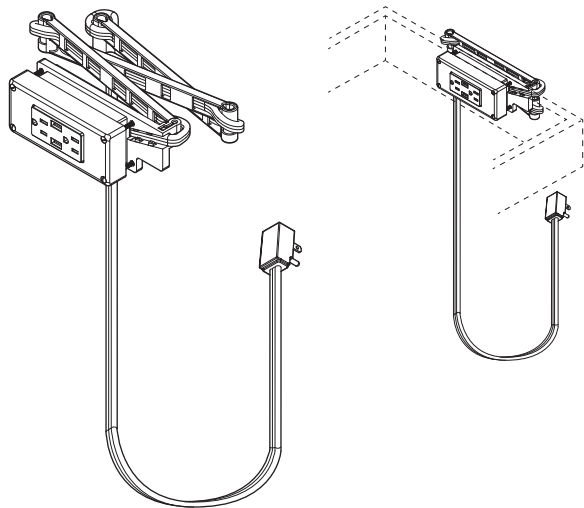

TILT-OUT TRAY, STAINLESS STEEL SLIM (TOTSSS)

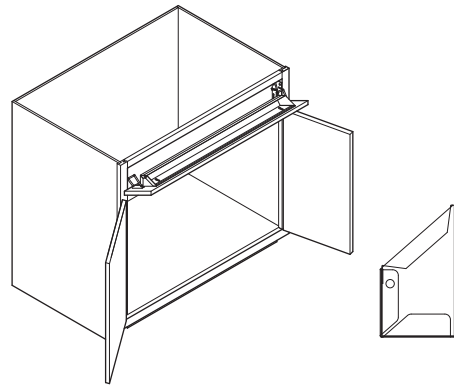

PUSH TO OPEN WASTEBASKET (PTOWB)

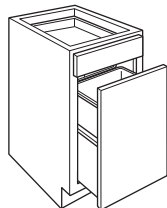

INTERIOR MODIFICATIONS (cont'd)

See page 2 for modification compatibility.

OPTION NAME	APPLICABLE CABINET GROUP	DESCRIPTION/LIMITATIONS	PRICING																		
Tray Dividers (TD)	Most wall, full height base, and tall cabinets	<p>Installs removable Tray Dividers. Plywood dividers match the interior of the cabinet. Rails for dividers are Natural Maple regardless of the color of the interior of the cabinet.</p> <p>Number of dividers is predetermined based on cabinet width. See chart below.</p> <p>Available only in the top of Stacked Walls and Tall Cabinets.</p> <p>Available with Reduced Depth modification (12" minimum) and Increased Depth modification (27" maximum). When cabinet is increased to 27", tray dividers will be 24" deep set back 3" into the cabinet.</p> <p>Base Full Height cabinets will have a top. Not available with Peninsula modification.</p> <p>Available on cabinets with frame height openings of 15"-27" with full top and bottom panels.</p> <table border="1" style="margin: 10px auto; border-collapse: collapse;"> <thead> <tr> <th style="text-align: center;">Cabinet Width</th> <th style="text-align: center;"># of Dividers</th> <th style="text-align: center;">Mod Name</th> </tr> </thead> <tbody> <tr> <td style="text-align: center;">9"-12"</td> <td style="text-align: center;">1</td> <td style="text-align: center;">1TD</td> </tr> <tr> <td style="text-align: center;">15"-18"</td> <td style="text-align: center;">2</td> <td style="text-align: center;">2TD</td> </tr> <tr> <td style="text-align: center;">21"-24"</td> <td style="text-align: center;">3</td> <td style="text-align: center;">3TD</td> </tr> <tr> <td style="text-align: center;">27"-31 1/2"</td> <td style="text-align: center;">4</td> <td style="text-align: center;">4TD</td> </tr> <tr> <td style="text-align: center;">33"-37"</td> <td style="text-align: center;">5</td> <td style="text-align: center;">5TD</td> </tr> </tbody> </table>	Cabinet Width	# of Dividers	Mod Name	9"-12"	1	1TD	15"-18"	2	2TD	21"-24"	3	3TD	27"-31 1/2"	4	4TD	33"-37"	5	5TD	<p>1TD: Cabinet list + \$186 2TD: Cabinet list + \$372 3TD: Cabinet list + \$558 4TD: Cabinet list + \$744 5TD: Cabinet list + \$930</p>
Cabinet Width	# of Dividers	Mod Name																			
9"-12"	1	1TD																			
15"-18"	2	2TD																			
21"-24"	3	3TD																			
27"-31 1/2"	4	4TD																			
33"-37"	5	5TD																			
Warming Drawer (DRWWRM)	Select base and tall oven cabinets	<p>Removes 6 3/8" deep drawer and all hardware. Includes one OCINSTALLKIT.</p> <p>On drawer bases, the middle drawer will be removed.</p>	No Upcharge																		

TRAY DIVIDERS (TD)

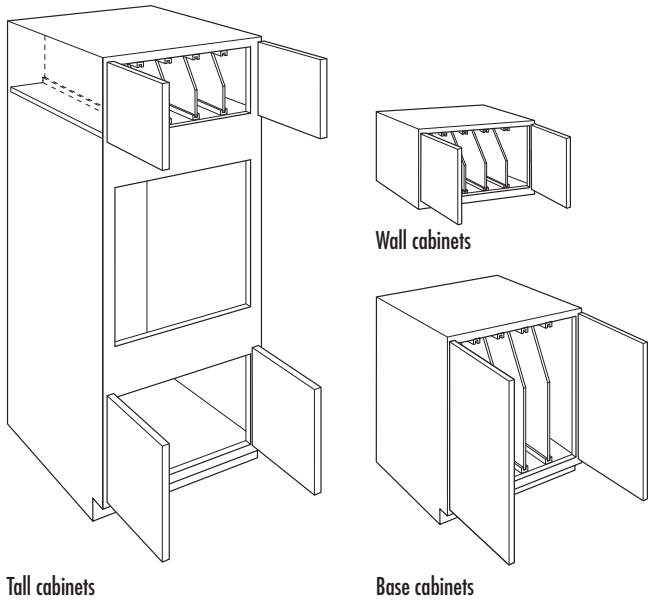

WARMING DRAWER (DRWWRM)

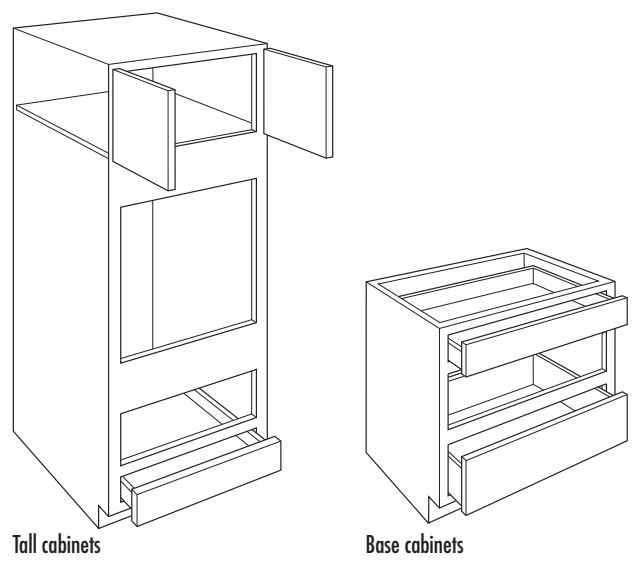

18 INTERIOR MODIFICATIONS

TOEKICK MODIFICATIONS

See page 2 for modification compatibility.

OPTION NAME	APPLICABLE CABINET GROUP	DESCRIPTION/LIMITATIONS	PRICING
Add Toekick (ADDTK)	Most wall cabinets	<p>Creates a 4 1/2" toekick on the front of cabinet. ADDTK with reduced depth is available on cabinets 9" deep or larger.</p> <p>Peninsula cabinets are available with ADDTK 15" deep and larger. Depths of 14" and less will not have ADDTK available.</p> <p>Furniture drawers will be available with ADDTK option down to a reduced depth of 12".</p> <p>Available with compatible toekick modifications. See the Modification/Upgrade Compatibility Chart on page 2 for details.</p>	No Upcharge
Flush Toekick (FTK) (FTK.FNT.P) (FTK.P)	Most base, tall, and vanity cabinets, and wall cabinets with ADDTK	<p>Extends the face frame to the floor eliminating the toe space. Not available when either RECTKL or RECTKR modifications are used.</p> <p>When FTK is ordered with the Peninsula modification, only the working drawer side will receive a flush toekick.</p> <p>When FTK.FNT.P is ordered with the Peninsula modification, both sides will receive a flush toekick.</p> <p>When FTK.P is ordered with the Peninsula modification, only the peninsula side will receive a flush toekick.</p>	No Upcharge

ADD TOEKICK (ADDTK)

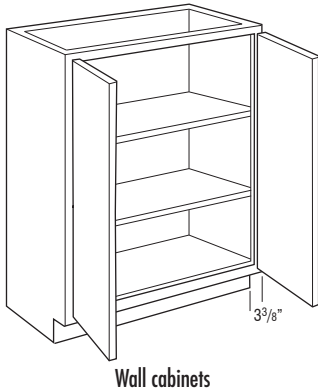

FLUSH TOEKICK (FTK)

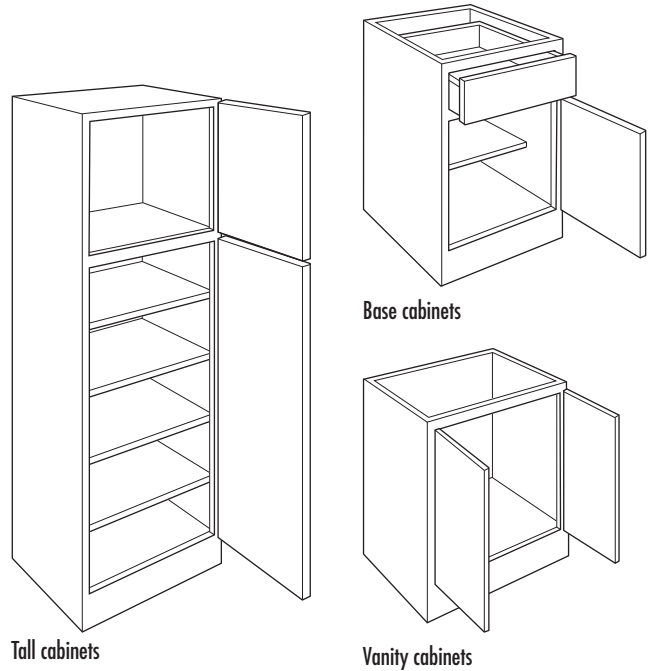

FLUSH TOEKICK FRONT & PENINSULA (FTK.FNT.P)

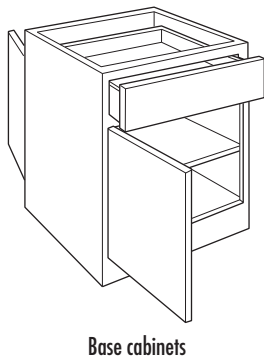

FLUSH TOEKICK PENINSULA (FTK.P)

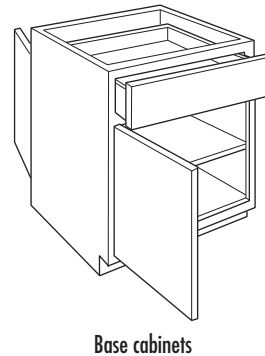

TOEKICK MODIFICATIONS (cont'd)

See page 2 for modification compatibility.

OPTION NAME	APPLICABLE CABINET GROUP	DESCRIPTION/LIMITATIONS	PRICING
Flush Toekick Arch (FTKAV) (FTKAV.P) (FTKAV.FNT.P)	Most base, tall, and vanity cabinets, and wall cabinets with ADDTK	Creates an arch flush toe space. Valance replaces standard toekick creating a full open area beneath cabinet floor. When FTKAV is ordered with the Peninsula modification, only the working drawer side will receive an arch flush toekick. When FTKAV.FNT.P is ordered with the Peninsula modification, both sides will receive an arch flush toekick. When FTKAV.P is ordered with the Peninsula modification, only the peninsula side will receive an arch flush toekick. Not available on 9" or 12" wide cabinets.	No Upcharge
Flush Toekick Furniture (FTKFV) (FTKFV.P) (FTKFV.FNT.P)	Most base, tall, and vanity cabinets, and wall cabinets with ADDTK	Creates a furniture flush toe space. Valance replaces standard toekick creating a full open area beneath cabinet floor. When FTKFV is ordered with the Peninsula modification, only the working drawer side will receive a furniture flush toekick. When FTKFV.FNT.P is ordered with the Peninsula modification, both sides will receive a furniture flush toekick. When FTKFV.P is ordered with the Peninsula modification, only the peninsula side will receive a furniture flush toekick. Not available on 9" or 12" wide cabinets.	No Upcharge

FLUSH TOEKICK ARCH (FTKAV)

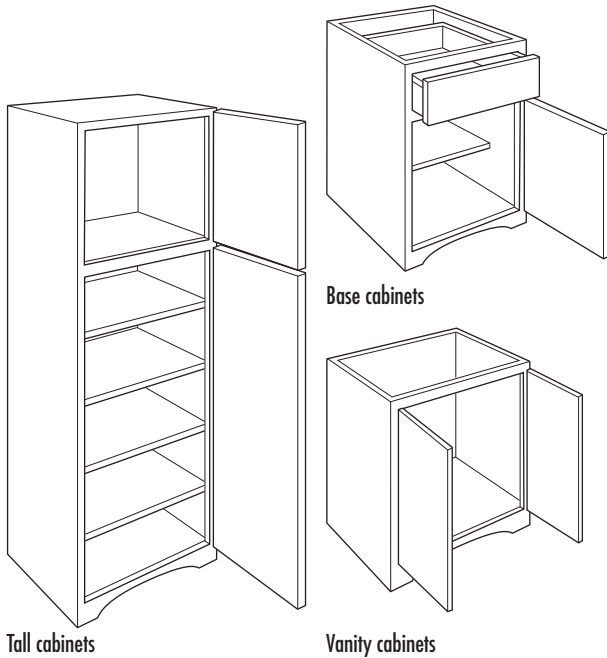

FLUSH TOEKICK FURNITURE (FTKFV)

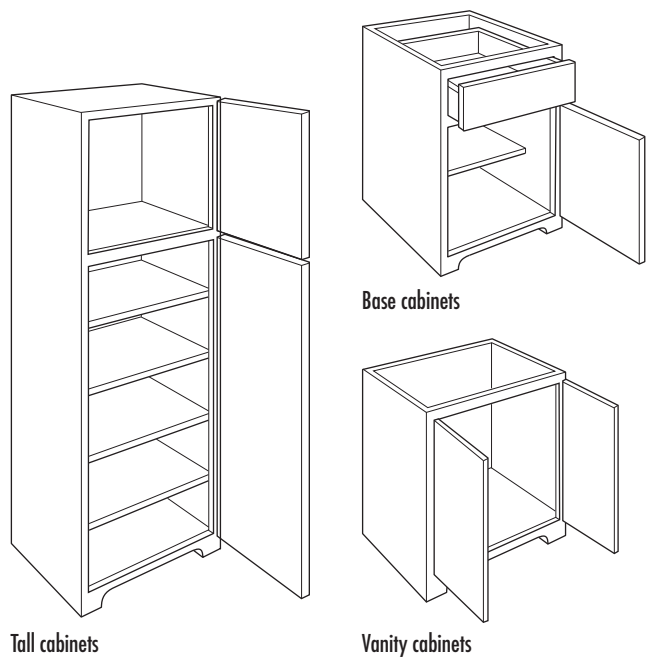

TOEKICK MODIFICATIONS (cont'd)

See page 2 for modification compatibility.

OPTION NAME	APPLICABLE CABINET GROUP	DESCRIPTION/LIMITATIONS	PRICING
Loose Toekick (TKP)	Most tall cabinets	Available on 84", 87", and 90" tall cabinets. Removes and ships the toekick separately. Not compatible with other toekick modifications. Pedestal is designed to create a Recessed Left or Right Toekick (RECTKL or RECTKR) application during field installation, or can be centered. Pedestal must be covered with toeboard material.	No Upcharge
Recessed Island Toekick (RECTKALL)	Most base, tall, and vanity cabinets, and wall cabinets with ADDTK	Creates a 3 3/8" recessed toekick on the right, left, and back of cabinet. The entire toekick area will have non-matching material and requires any exposed toekick area to be covered. RECTKALL only available on cabinets at least 15" deep.	No Upcharge
Recessed Toekick on Back or Side (RECTKBK) (RECTKL) (RECTKR)	Most base, tall, and vanity cabinets, and wall cabinets with ADDTK	Creates a 3 3/8" recessed toekick on the back (RECTKBK), left (RECTKL), or right (RECTKR). When either the RECTKR or RECTKL are used, FTK is NOT available. The entire toekick will have non-matching material and requires any exposed toekick area to be covered. On RECTKL and RECTKR, the back will have a 3/8" recessed offset and non-specified side will have a 1/2" recessed offset to allow for application of toeboard material. 93" and 96" tall cabinets have RECTKL or RECTKR standard on loose pedestal. For recess toekick applications of both left and right, order RECTKL.R. On 9" wide cabinets, only one side can be recessed. RECTKBK only available on cabinets at least 15" deep.	No Upcharge

LOOSE TOEKICK (TKP)

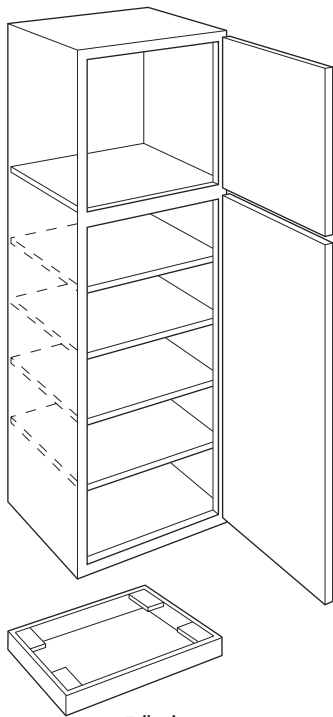

Tall cabinets

Pedestal is reduced in width for RECTKL or RECTKR during field installation.

RECESSED ISLAND TOEKICK (RECTKALL)

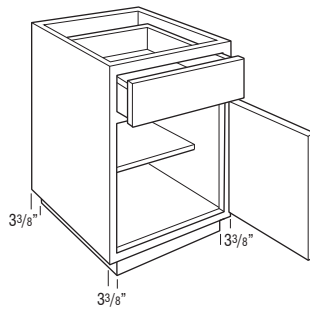

Base cabinets

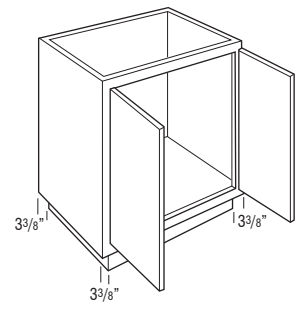

Vanity cabinets

RECESSED TOEKICK - BACK (RECTKBK)

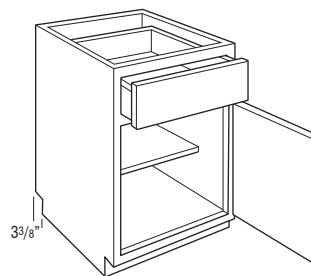

Base cabinets

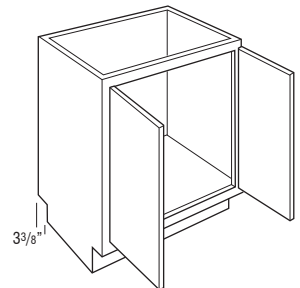

Vanity cabinets

RECESSED TOEKICK - LEFT (RECTKL)

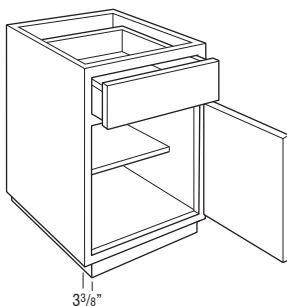

Base cabinets

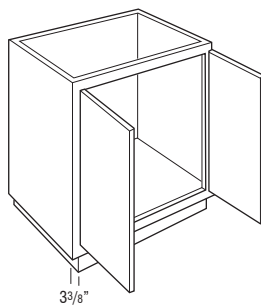

Vanity cabinets

RECESSED TOEKICK - RIGHT (RECTKR)

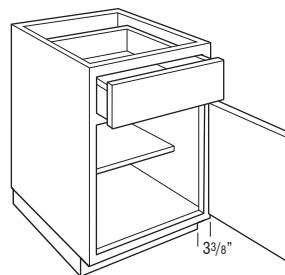

Base cabinets

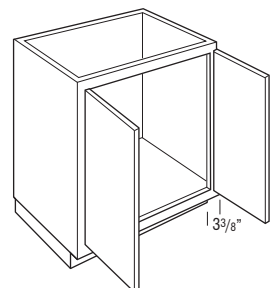

Vanity cabinets

TOEKICK MODIFICATIONS (cont'd)

See page 2 for modification compatibility.

OPTION NAME	APPLICABLE CABINET GROUP	DESCRIPTION/LIMITATIONS	PRICING
Toekick Drawer (DRWTK)	Most cabinets with a standard toekick, and wall cabinets with ADDTK	Replaces standard toekick with a toekick drawer. Available on most 21"-24" deep cabinets in 18", 21", 24", 27", 30", 33", and 36" widths that have standard toekick construction. Front of toekick drawer is unfinished, allow enough toeboard to cover. 1" clearance below toekick drawer. Exterior dimensions of drawer are 3 3/8" tall and 15" or 18" deep. Toekick drawer uses a push to open full extension side-mount guide, does not have soft-close feature.	\$539 list
Void Toekick (VTK)	Most base, tall, and vanity cabinets	Removes the toekick. Only available when the cabinet has a standard toekick (not available when flush toekick is standard or when cabinet has a separate pedestal base). When VTK is specified on cabinets to be used with a countertop, cabinets must also be supported from the floor, not just attached to the wall. Failure to properly install cabinets in this situation will void the warranty.	No Upcharge

TOEKICK DRAWER (DRWTK)

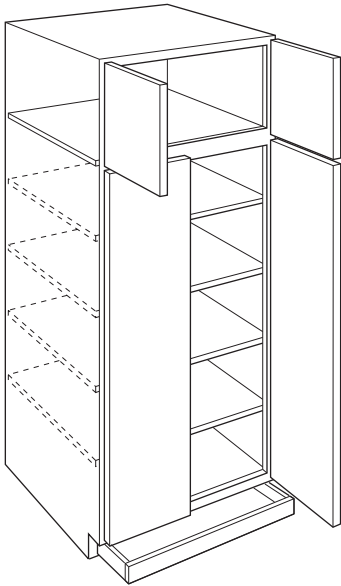

Tall cabinets

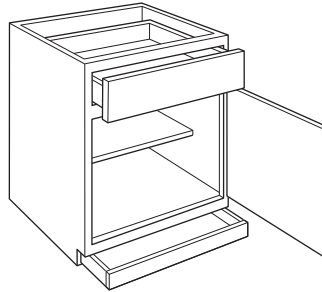

Base cabinets

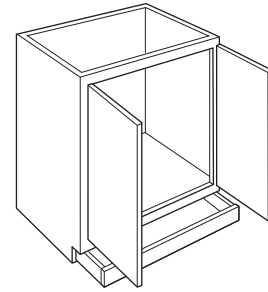

Vanity cabinets

VOID TOEKICK (VTK)

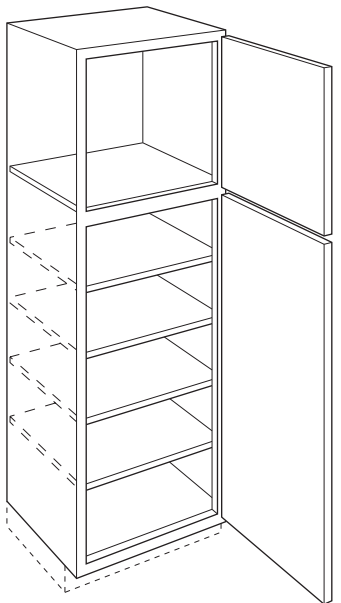

Tall cabinets

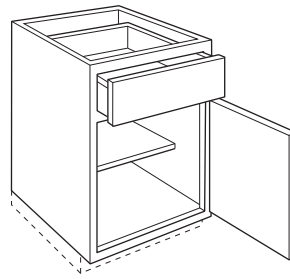

Base cabinets

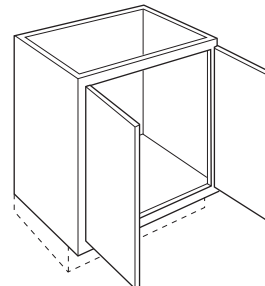

Vanity cabinets

CONFIGURATION MODIFICATIONS

See page 2 for modification compatibility.

OPTION NAME	APPLICABLE CABINET GROUP	DESCRIPTION/LIMITATIONS	PRICING
Cabinet Front Only (CFNTO)	Most cabinets with a face frame	Creates a door and/or drawer front assembled with a frame. Doors are attached with the specified hinges and drawer fronts are cleated. Premium Door Mechanism not included.	Wall: 70% of cabinet list Base & Tall: 80% of cabinet list
Cabinet Frame Only (CFRMO)	Most cabinets with a face frame	Creates a cabinet frame only. No box, doors, or drawer fronts are included.	25% of cabinet list
Peninsula (P)	Most wall and base cabinets	Creates a peninsula cabinet that is 1/4" deeper than the standard cabinet depth. If ID or RD is specified, cabinet will be 1/4" deeper than specified cabinet depth. Any adjustable shelves are upgraded to full depth. Any cabinet with a toekick must be at least 15" deep (either standard with a toekick or when ADDTK is specified). Single door cabinets are hinged on the same cabinet end, for example a W1230L will feature a Left hinge on the front side and a Right hinge on the peninsula side. Not available on tall cabinets (oven, utility, and pantry) or multi-drawer base cabinets. Cabinets with drawers can only be reduced in 3" increments. Wall peninsula cabinets are not designed to be used as stand alone island cabinets. The maximum depth for wall cabinets with the Peninsula modification is 18".	Cabinet list + 80%

CABINET FRONT ONLY (CFNTO)

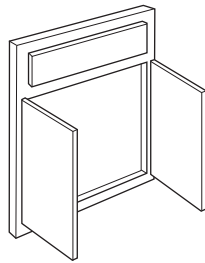

Cabinet front only – Wall, Base, and Tall

CABINET FRAME ONLY (CFRMO)

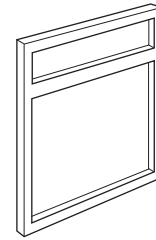

Cabinet frame only – Wall, Base, and Tall

PENINSULA (P)

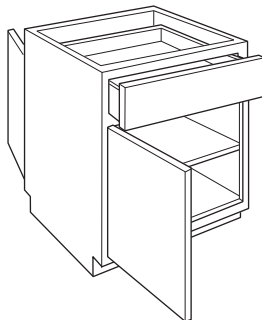

Base cabinets

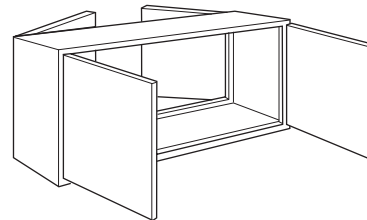

Wall cabinets

ALUMINUM FRAME DOOR OPTIONS

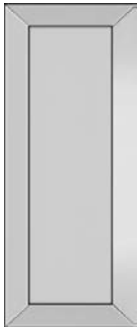

ALF
Aluminum Frame Door
in Aluminum finish
with Frost glass



ALFBS
Aluminum Frame Door
with a Brushed Stainless
Steel look with Frost glass



ALFBL
Aluminum Frame Door
with a Black powder coat
finish with Frost glass

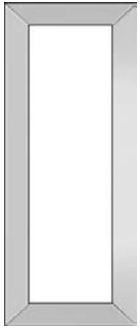

ALFC
Aluminum Frame Door
in Aluminum finish
with Clear glass

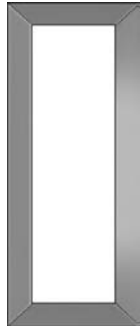

ALFBS
Aluminum Frame Door
with a Brushed Stainless Steel
look with Clear glass



ALFBL
Aluminum Frame Door
with a Black powder coat
finish with Clear glass

- All aluminum doors will be full overlay with mitered construction.
- Cabinet face frame and end panels will be matched to the finish specified.
- Aluminum and Brushed Stainless doors have an anodized finish.
- Black doors have a powder coated finish.
- Glass and matching panel are installed in door, removal will void warranty.
- Door rails are 2 1/4" wide.
- All Aluminum Frame door options are represented by ALF in Door Options availability grids.
- Cabinet will have standard interior or can be ordered with MIP option. When a decorative door option is chosen in 20/20, Matching Interior Plywood (MIP) is a preselected option. If MIP is not desired, it can be deselected by choosing NOTMIP.
- Aluminum Frame Door options are compatible with Face Frame and Door on End modifications (FFDL and FFDR). The ALF_ door upcharge will also apply to the side door.

ALF AVAILABILITY

Cabinet Width	Cabinet Height					
	12"	15"	18"	21"	30"	36"
W12	N/A	N/A	N/A	N/A	B	C
W15	A	A	N/A	N/A	B	C
W18	A	A	N/A	N/A	B	C
W21	N/A	N/A	N/A	N/A	B	C
WTH30 & WTH30..24	B	B	B	B	N/A	N/A
WVL30 & WVL30..24	N/A	N/A	B	B	N/A	N/A
WTH36 & WTH36..24	C	C	C	C	N/A	N/A
WVL36 & WVL36..24	N/A	N/A	C	C	N/A	N/A

ALF LIST PRICE PER DOOR

Code	A	B	C
ALF	564	626	689
ALFC	564	626	689
ALFBS	988	1047	1108
ALFBS	988	1047	1108
ALFBL	1145	1204	1265
ALFBL	1145	1204	1265

To price ALF door attached to a cabinet, add the list price per door to the cabinet price (MIP modification upcharge will be applied to the cabinet price if matching interior is desired).

For a door only (not specified on a cabinet), add the list price for a door only to the Aluminum Frame door list price. See Doors and Drawer Fronts on page 321 for details.

CUT-FOR-GLASS DOORS (CG)

Glass not included

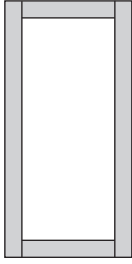

Cut-for-glass

- If ordered in an MDF door style, door will be Maple. On Stacked Wall (STW__) and Utility cabinets (U__), all cabinet doors will be Maple when ordered with a Cut-for-glass Door.
- Not available on bifold doors.
- Custom door sizes available. See pages 274-278.
- For cabinet availability, please see modification grids.
- CG.TOP and CG.BTM are specified on cabinets with upper and lower doors to designate which doors should be Cut-for-glass. See Door Options grid for SKU availability.
- When a decorative door option is chosen in 20/20, Matching Interior Plywood (MIP) is a preselected option. If MIP is not desired, it can be deselected by choosing NOTMIP.
- All textured glass panels will be drop shipped separately from the cabinet order.
- Glass installation clips will ship with the doors and/or cabinets.
- The use of glass for base cabinet applications or for placement near interior or exterior doors is not recommended.

MODEL

PRICE

List per Door

Cut-for-glass Door To Fit

96

To price Cut-for-glass Doors attached to a cabinet, add the list price per door to the cabinet price (MIP modification upcharge will be applied to the cabinet price if matching interior is desired).

For a door only (not specified on a cabinet), add the list price for a door only to the Cut-for-glass door list price. See Doors and Drawer Fronts on page 321 for details.

MULLION DOORS (MD)

Glass not included

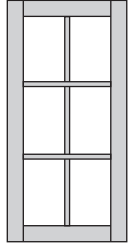

Mullion

- Custom Door Sizes not available.
- For Mullion Door availability, please see modification grids in wall section.
- If ordered in an MDF door style, door will be Maple.
- Pricing includes mullion door only. Glass may be ordered separately. See page 33 for details.
- Not compatible with Beveled glass.
- MD.TOP and MD.BTM are specified on cabinets with upper and lower doors to designate which doors should be Mullion Doors. See Door Options grid for SKU availability.
- Shelves will not align with mullions.
- When a decorative door option is chosen in 20/20, Matching Interior Plywood (MIP) is a preselected option. If MIP is not desired, it can be deselected by choosing NOTMIP.
- All textured glass panels will be drop shipped separately from the cabinet order.
- Glass installation clips will ship with the doors and/or cabinets.
- The use of glass for base cabinet applications or for placement near interior or exterior doors is not recommended.

MODEL	PRICE
Mullion Door Only To Fit:	List per Door
15" High Wall Cabinet	405
18" High Wall Cabinet	405
24" High Wall Cabinet	424
30" High Wall Cabinet	424
33" High Wall Cabinet	441
36" High Wall Cabinet	441
39" High Wall Cabinet	441
42" High Wall Cabinet	441

To price Mullion Doors attached to a cabinet, add the list price per door to the wall cabinet price (MIP modification upcharge will be applied to the cabinet price if matching interior is desired).

For a door only (not specified on a cabinet), add the list price for a door only to the Mullion door list price. See Doors and Drawer Fronts on page 321 for details.

MULLION LITES GRID

Cabinet Width*	Cabinet Height							
	15"	18"	24"	30"	33"	36"	39"	42"
W15	G	G	G	D	D	D	A	A
W18	G	G	G	D	D	D	A	A
W21	G	G	G	D	D	D	A	A
W24	G	G	G	D	D	D	A	A
W24 (butt)	G	G	G	D	D	D	A	A
W27 (butt)	G	G	G	D	D	D	A	A
W30 (butt)	G	G	G	D	D	D	A	A
W33 (butt)	G	G	G	D	D	D	A	A
W36 (butt)	G	G	G	D	D	D	A	A
W42 (CS)	G	G	G	D	D	D	A	A
W45 (CS)		G	G	D	D	D	A	A
W48 (CS)		G	G	D	D	D	A	A
W48 (butt)	G	G	G	D	D	D	A	A
WC30				D	D	D	A	A
WC33				D	D	D	A	A
WC36				D	D	D	A	A
WC39				D	D	D	A	A
WC42				D	D	D	A	A
WC45				D	D	D	A	A
WC48				D	D	D	A	A
DW	G	G	G	D	D	D	A	A

*Stacked wall cabinets (STW__ and STWC__) also available with MD option in selected widths.

Mullion Door Configurations

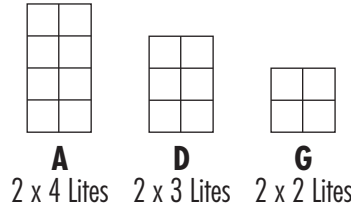

SHAKER MULLION DOORS (SHMD)

Glass not included

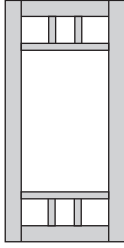

- Custom Door Sizes not available.
- Shelves will not align with mullions.
- For Mullion Door availability, please see modification grids in wall section.
- If ordered in an MDF door style, door will be Maple.
- Pricing includes mullion door only. Glass may be ordered separately. See page 33 for details.
- Not compatible with Beveled glass.
- When a decorative door option is chosen in 20/20, Matching Interior Plywood (MIP) is a preselected option. If MIP is not desired, it can be deselected by choosing NOTMIP.
- All textured glass panels will be drop shipped separately from the cabinet order.
- Glass installation clips will ship with the doors and/or cabinets.
- The use of glass for base cabinet applications or for placement near interior or exterior doors is not recommended.

MODEL	PRICE
Mullion Door Only To Fit:	List per Door
18" High Wall Cabinet	405
24" High Wall Cabinet	424
30" High Wall Cabinet	424
33" High Wall Cabinet	441
36" High Wall Cabinet	441
39" High Wall Cabinet	441
42" High Wall Cabinet	441

To price Shaker Mullion Doors attached to a cabinet, add the list price per door to the wall cabinet price (MIP modification upcharge will be applied to the cabinet price if matching interior is desired).

For a door only (not specified on a cabinet), add the list price for a door only to the Shaker Mullion door list price. See Doors and Drawer Fronts on page 321 for details.

MULLION SHAKER LITES GRID

Cabinet Width*	Cabinet Height						
	18"	24"	30"	33"	36"	39"	42"
W15†	H	H	H	H	H	H	H
W18	H	H	H	H	H	H	H
W21	H	H	H	H	H	H	H
W24	H	H	H	H	H	H	H
W24 (butt)	J	J	J	J	J	J	J
W27 (butt)	J	J	J	J	J	J	J
W30 (butt)†	H	H	H	H	H	H	H
W33 (butt)	H	H	H	H	H	H	H
W36 (butt)	H	H	H	H	H	H	H
W42 (CS)	H	H	H	H	H	H	H
W45 (CS)	H	H	H	H	H	H	H
W48 (CS)	H	H	H	H	H	H	H
W48 (butt)	J	J	J	J	J	J	J
WC30	J	J	J	J	J	J	J
WC33			H	H	H	H	H
WC36			H	H	H	H	H
WC39			J	J	J	J	J
WC42			J	J	J	J	J
WC45			H	H	H	H	H
WC48			H	H	H	H	H
DW†	H	H	H	H	H	H	H

Shaker Mullion Door Configurations

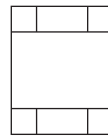

H
3 x 3 Lites

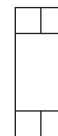

J
2 x 3 Lites

*Stacked wall cabinets (STW__ and STWC__) also available with SHMD option in selected widths.

†Certain door styles will have "J Configuration" for 15" and 30" wide cabinets and all DW cabinets. See Door Style section for exceptions.

PRAIRIE MULLION DOORS (PRMD)

Glass not included

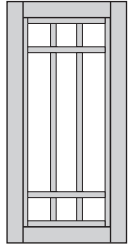

- Custom Door Sizes not available.
- Shelves will not align with mullions.
- For Mullion Door availability, please see modification grids in wall section.
- If ordered in an MDF door style, door will be Maple.
- Pricing includes mullion door only. Glass may be ordered separately. See page 33 for details.
- Not compatible with Beveled glass.
- When a decorative door option is chosen in 20/20, Matching Interior Plywood (MIP) is a preselected option. If MIP is not desired, it can be deselected by choosing NOTMIP.
- All textured glass panels will be drop shipped separately from the cabinet order.
- Glass installation clips will ship with the doors and/or cabinets.
- The use of glass for base cabinet applications or for placement near interior or exterior doors is not recommended.

MODEL	PRICE
Mullion Door Only To Fit:	List per Door
18" High Wall Cabinet	405
24" High Wall Cabinet	424
30" High Wall Cabinet	424
33" High Wall Cabinet	441
36" High Wall Cabinet	441
39" High Wall Cabinet	441
42" High Wall Cabinet	441

To price Prairie Mullion Doors attached to a cabinet, add the list price per door to the wall cabinet price (MIP modification upcharge will be applied to the cabinet price if matching interior is desired).

For a door only (not specified on a cabinet), add the list price for a door only to the Prairie Mullion door list price. See Doors and Drawer Fronts on page 321 for details.

MULLION PRAIRIE LITES GRID

Cabinet Width*	Cabinet Height						
	18"	24"	30"	33"	36"	39"	42"
W15†	K	K	K	K	K	K	K
W18	K	K	K	K	K	K	K
W21	K	K	K	K	K	K	K
W24	K	K	K	K	K	K	K
W24 (butt)	L	L	L	L	L	L	L
W27 (butt)	L	L	L	L	L	L	L
W30 (butt)†	K	K	K	K	K	K	K
W33 (butt)	K	K	K	K	K	K	K
W36 (butt)	K	K	K	K	K	K	K
W42 (CS)	K	K	K	K	K	K	K
W45 (CS)	K	K	K	K	K	K	K
W48 (CS)	K	K	K	K	K	K	K
W48 (butt)	L	L	L	L	L	L	L
WC30	L	L	L	L	L	L	L
WC33			K	K	K	K	K
WC36			K	K	K	K	K
WC39			L	L	L	L	L
WC42			L	L	L	L	L
WC45			K	K	K	K	K
WC48			K	K	K	K	K
DW†	K	K	K	K	K	K	K

Prairie Mullion Door Configurations

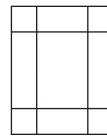

K
3 x 3 Lites



L
2 x 3 Lites

*Stacked wall cabinets (STW__ and STWC__) also available with PRMD option in selected widths.

†Certain door styles will have "L Configuration" for 15" and 30" wide cabinets and all DW cabinets. See Door Style section for exceptions.

ART GLASS PANELS



Anson

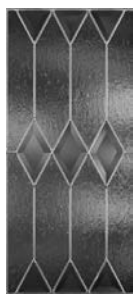

Avondale



Charlotte



Lanai

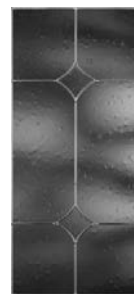

Lonsdale

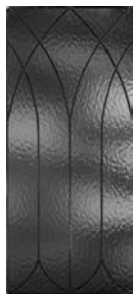

Lyndhurst



Pavillion

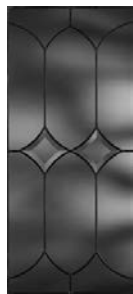

Portico



Silhouette



Waterbury

- Available in most door styles with CG availability. See Door Style section for exceptions.
- Cut-for-glass doors must be ordered separately. See page 25 for door style availability.
- For glass shelf kits, see page 306.
- Door frame may reduce amount of glass shown.
- No changes or cancellations will be accepted after 24 hours from acknowledgment of order.
- Art glass will be packaged separately from applicable cabinet(s) and shipped with cabinet order for field installation.
- The use of glass for base cabinet applications or for placement near interior or exterior doors is not recommended.

STYLE	PANEL THICKNESS	CAMING MATERIAL	HEIGHT		
			12", 15", 18" TALL	21", 24", 27", 30" TALL	33", 36", 39", 42" TALL
Anson	1/4"	Zinc Black Patina	449	499	549
Avondale	1/4"	Zinc	674	748	824
Charlotte	1/4"	Zinc	604	671	739
Lanai	1/4"	Zinc	604	671	739
Lonsdale	1/4"	Zinc	449	499	549
Lyndhurst	1/4"	Zinc Black Patina	579	643	707
Pavillion	1/4"	Zinc	403	447	493
Portico	1/4"	Zinc Black Patina	505	562	619
Silhouette	1/8"	N/A	280	310	341
Waterbury	1/4"	Zinc Black Patina	535	593	653

ART GLASS PANELS

Anson

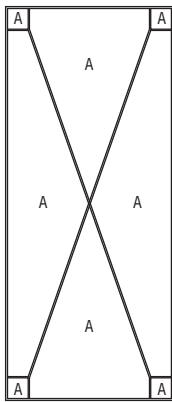

Minimum Size
6" x 6"



1 3/8"
1 3/8"

Glass Type:
A) Clear Seedy 100SDY

Metal Type:
3/16" H-Ch Zinc Proglaze2 (all)
Black Patina Finish

Charlotte

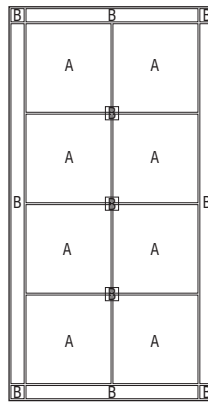

Heights > 23"
3 Horizontal Bars

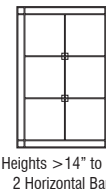

Heights > 14" to 23"
2 Horizontal Bars

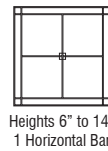

Heights 6" to 14"
1 Horizontal Bar



Overlay
1 5/16" x 1 5/16"

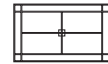

Minimum Size
10" x 6"

Glass Types:
A) 1/8" Clear
B) Frost Etch 100

Metal Types:
3/16" H-Ch Zinc Proglaze2 (all)
1/8" U-Ch Zinc (overlays)

Avondale

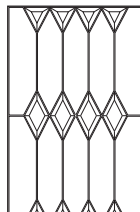
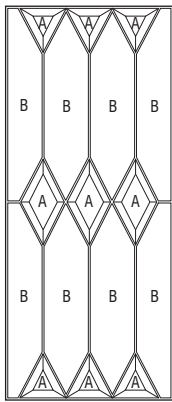

Widths > 13"
4 Vertical Columns

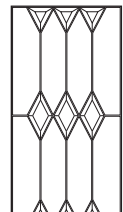

Widths > 10" to 13"
3 Vertical Columns

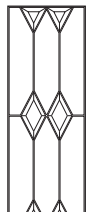

Widths > 7" to 10"
2 Vertical Columns



1 3/8"
3"



1 3/8"
6"

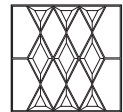

Heights > 13"
Full Design

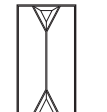

Widths 6" to 7"
1 Vertical Column

Glass Types:
A) 3/16" Clear with 1/2" Bevel
B) Clear Vecchio 100V

Metal Type:
3/16" H-Ch Zinc Proglaze2 (all)



Heights < 13"
Diamond(s) Only



Minimum Size
6" x 6 1/4"

Lanai

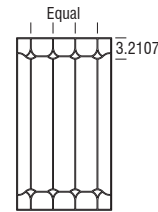

Widths > 16"
4 Vertical Columns

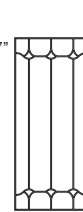

Widths > 11" to 16"
3 Vertical Columns

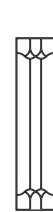

Widths 6" to 11"
2 Vertical Columns

Equal

3.2107"

Glass Type:
A) 1/8" Clear

Metal Type:
3/16" H-Ch Zinc Proglaze2 (all)

ART GLASS PANELS

Lonsdale

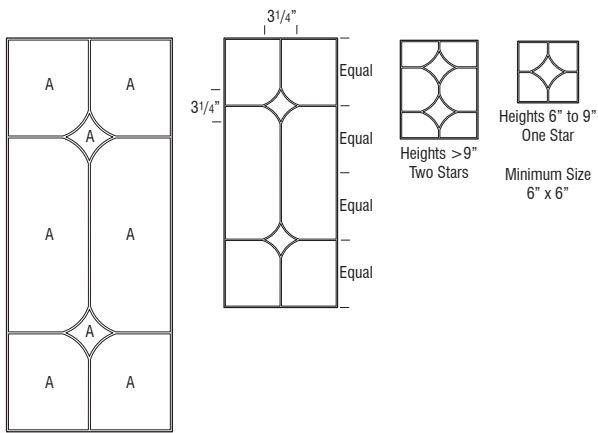

Glass Type:
A) Seedy Clear 100Sdy
Metal Type:
3/16" H-Ch Zinc Proglaze2 (all)

Pavillion

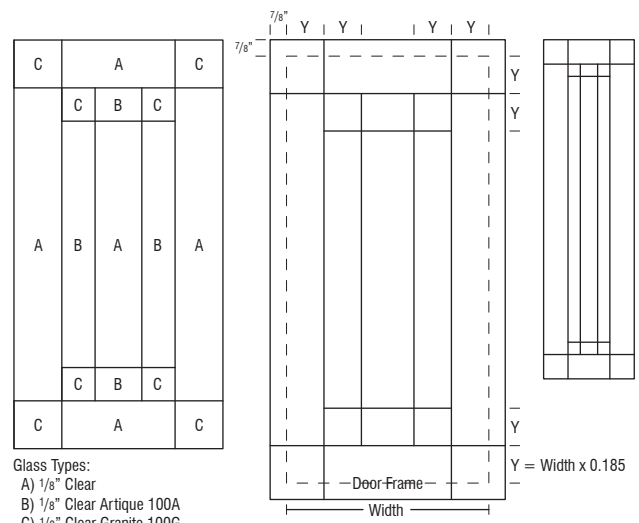

Glass Types:
A) 1/8" Clear
B) 1/8" Clear Artique 100A
C) 1/8" Clear Granite 100G
Metal Type:
3/16" H-Ch Round Zinc Proglaze2 (all)

Lyndhurst

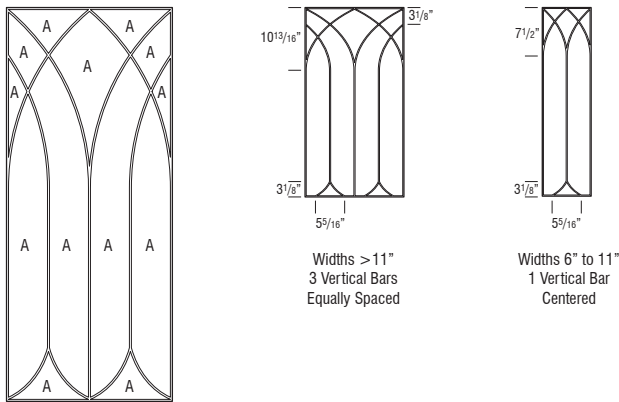

Glass Type:
A) Clear Rough Rolled 100RR
Metal Type:
3/16" H-Ch Zinc Proglaze2 (all)
Black Patina Finish
Minimum Size 6" x 12"

Portico

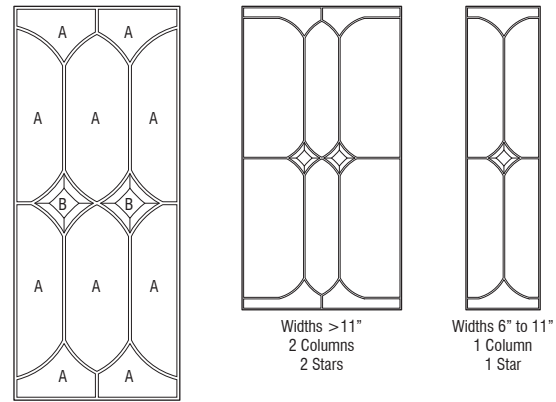

Glass Types:
A) 1/8" Clear
B) 3/16" Clear with 1/2" Bevel
Metal Type:
3/16" H-Ch Zinc Proglaze2 (all)
Black Patina Finish
Minimum Size 6" x 12"

ART GLASS PANELS

Silhouette

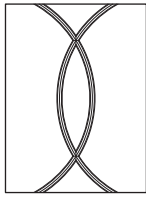
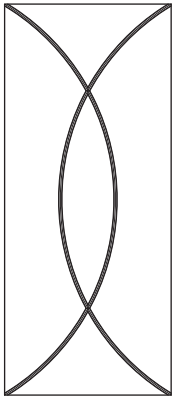

When the Width is Greater Than 2/3 the Height, the Design is Centered and Does Not Finish in the Corners

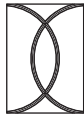

Minimum Size
Height 8 1/2"
Width 6"

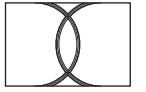

Width Greater Than Height*

- Glass type: Frost Etch
- Panel thickness: 1/8"

*Not recommended for use with certain door styles. See Door Style section for exceptions.

Waterbury

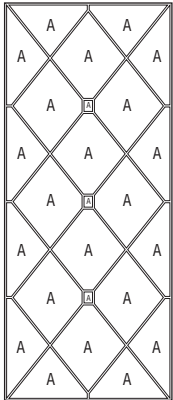

Glass Type:
A) Clear Waterglass 100W

Metal Type:
3/16" H-Ch Zinc Proglaze2 (all)
Black Patina Finish

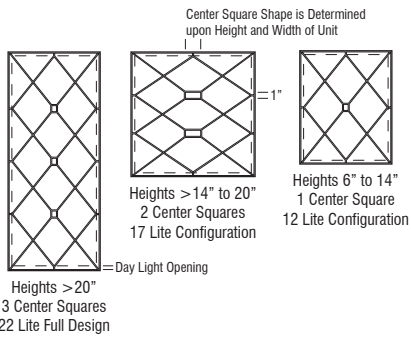

Minimum Size
6" x 6"

TEXTURED GLASS PANELS



Antique



Bevel



Clear



Frost

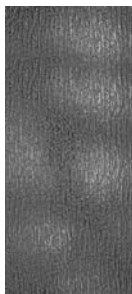

Rain

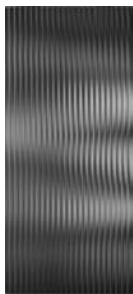

Reeded



Seeded

- Cut-for-glass and Mullion doors must be ordered separately. See pages 25-28 for door style availability.
- For glass shelf kits, see page 306.
- When textured glass is ordered for use in wall top hinge (WTH) or wall vertical-lift (WVL) cabinets, glass design will be turned horizontally and may not match desired pattern.
- Door frame may reduce amount of glass shown.
- No changes or cancellations will be accepted after 24 hours from acknowledgment of order.
- All textured glass panels will be drop shipped separately from the cabinet order.
- Glass installation clips will ship with the doors and/or cabinets.
- The use of glass for base cabinet applications or for placement near interior or exterior doors is not recommended.
- Bevel glass not recommended for use with Mullion doors.

STYLE	PANEL THICKNESS	HEIGHT		
		12", 15", 18" TALL	21", 24", 27", 30" TALL	33", 36", 39", 42" TALL
Antique	1/8"	215	239	262
Bevel	1/4"	215	239	262
Clear	1/8"	182	202	222
Frost	5/32"	215	239	262
Rain	5/32"	338	376	414
Reeded	5/32"	182	202	222
Seeded	1/8"	338	376	414

TEXTURED GLASS PANELS

Antique



- Glass type: Antique
- Panel thickness: 1/8"

Bevel

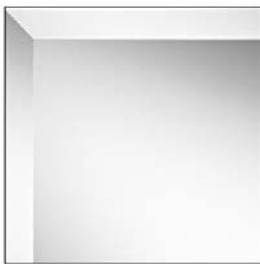

- Glass type: Clear
- Panel thickness: 1/4"
- Not compatible with Mullion Doors.

Clear

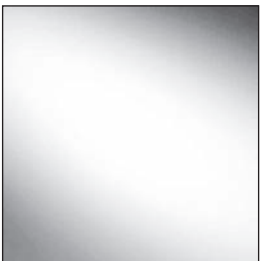

- Glass type: Clear
- Panel thickness: 1/8"

Frost

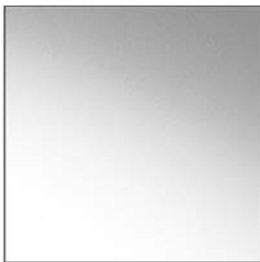

- Glass type: Frost
- Panel thickness: 5/32"

Rain

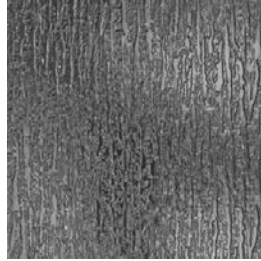

- Glass type: Rain
- Panel thickness: 5/32"

Reeded

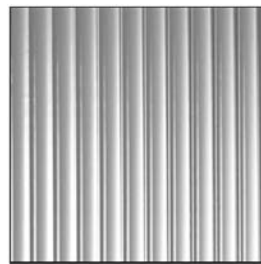

- Glass type: Reeded
- Panel thickness: 5/32"

Seeded

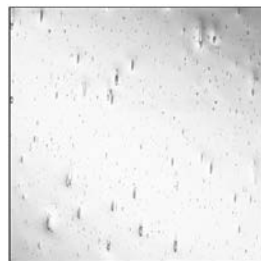

- Glass type: Seeded
- Panel thickness: 1/8"

CABINET DIMENSIONS

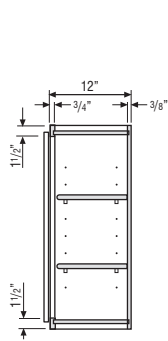

WALL CABINET

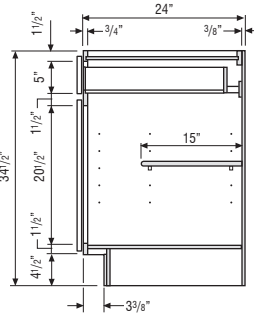

BASE CABINET

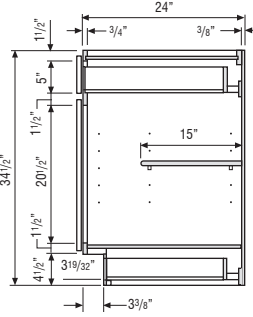

**BASE CABINET
with TOEKICK DRAWER**

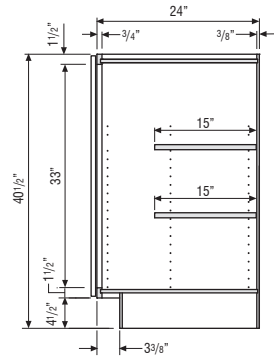

**40 1/2" HIGH
FULL HEIGHT
BASE CABINET**

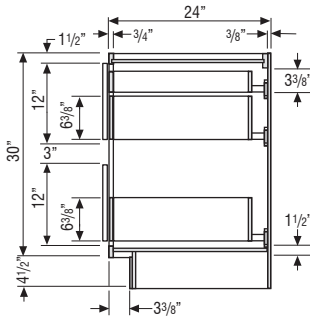

**TWO-DRAWER
BASE CABINET
with ROLL TRAY**

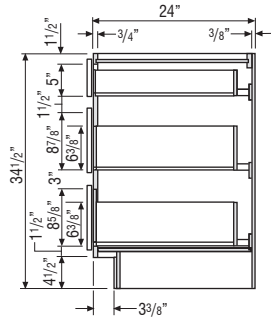

**THREE-DRAWER
BASE CABINET**

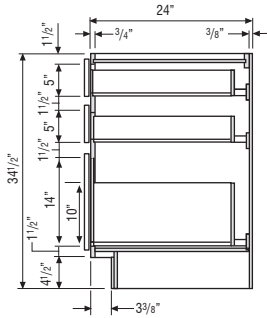

**THREE-DRAWER
BASE CABINET
with DEEP DRAWER**

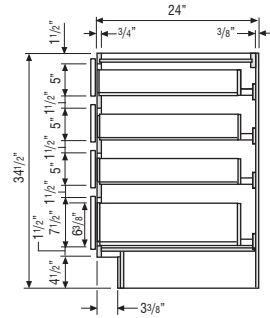

**FOUR-DRAWER
BASE CABINET**

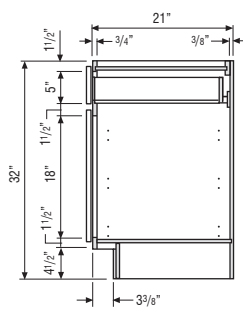

**32" HIGH
VANITY CABINET**

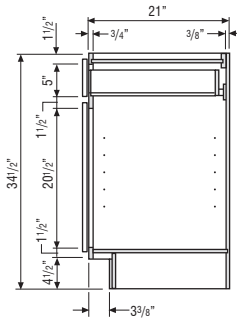

**34 1/2" HIGH
VANITY CABINET**

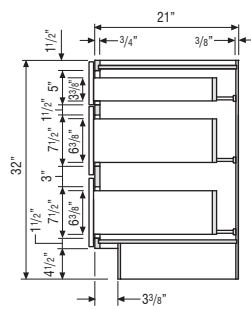

**32" HIGH
VANITY DRAWER
BASE CABINET**

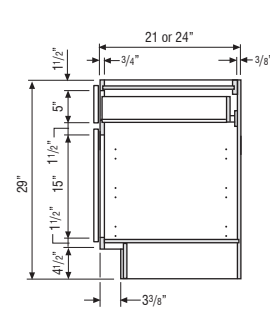

DESK BASE CABINET

CABINET DIMENSIONS

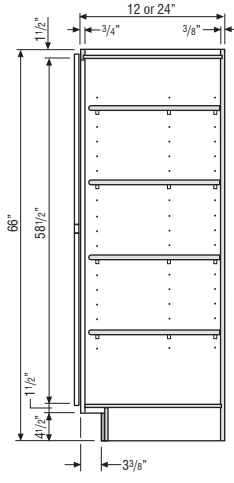

UTILITY CABINET

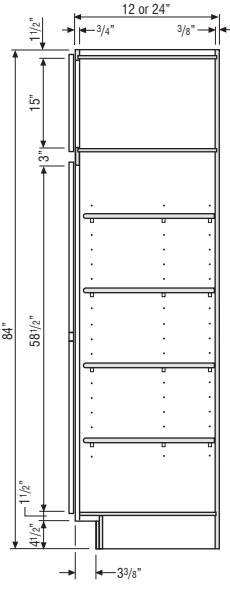

UTILITY CABINET

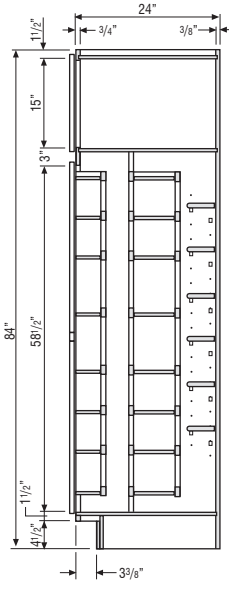

PANTRY CABINET

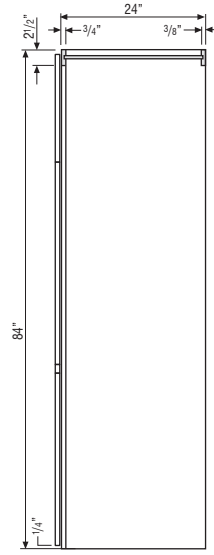

PANTRY WALK-THROUGH

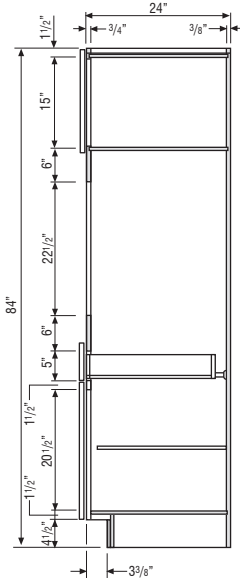

SINGLE OVEN CABINET

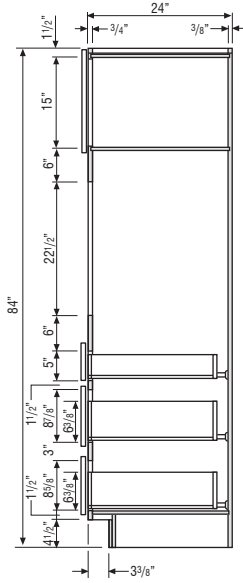

SINGLE OVEN CABINET
THREE-DRAWER BASE

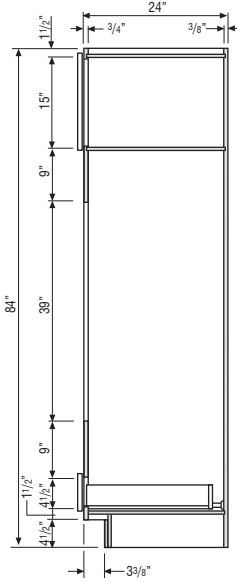

DOUBLE OVEN CABINET

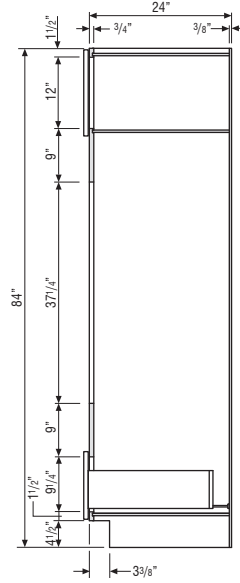

DOUBLE OVEN CABINET
DEEP DRAWER

CABINET DIMENSIONS

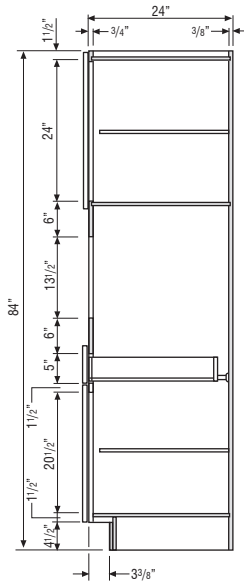

**TALL BUILT-IN
MICROWAVE CABINET**

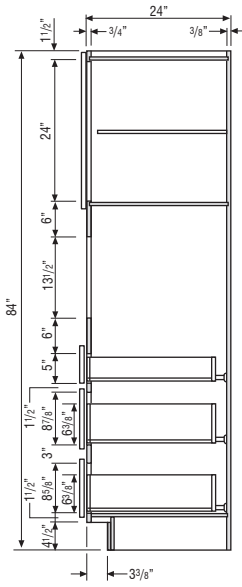

**TALL BUILT-IN
MICROWAVE CABINET
THREE-DRAWER BASE**

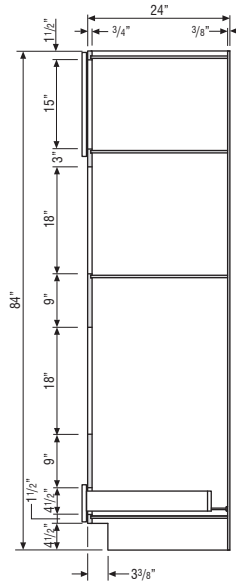

**OVEN MICROWAVE
CABINET**

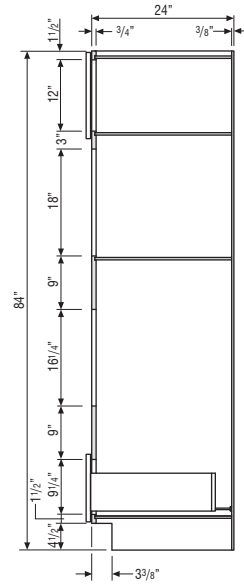

**OVEN MICROWAVE
CABINET
DEEP DRAWER**

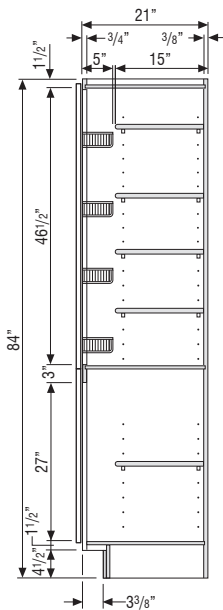

**LCRH/LT
CABINET**
(Aligns with 34 1/2" High
Vanity Base Cabinets)

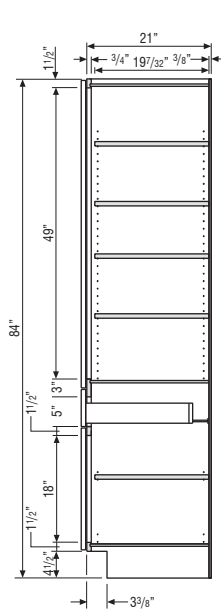

**LINEN TALL
with DRAWER**
(Aligns with 32" High
Vanity Base Cabinets)

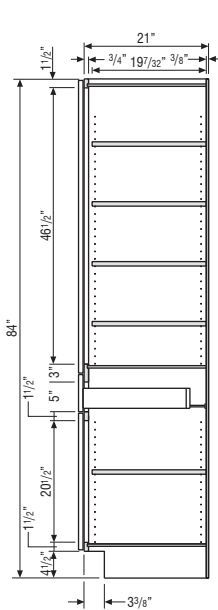

**LINEN TALL
with DRAWER**
(Aligns with 34 1/2" High
Vanity Base Cabinets)

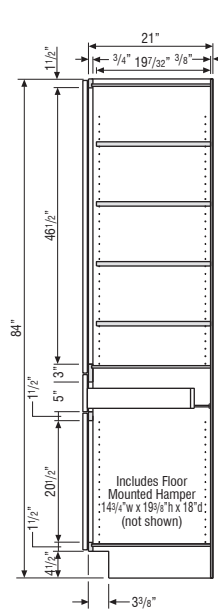

**LINEN TALL with DRAWER
and REMOVABLE HAMPER**
(Aligns with 34 1/2" High
Vanity Base Cabinets)

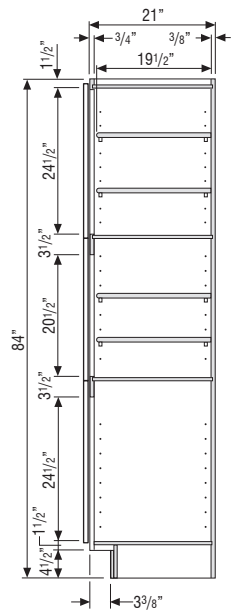

**VANITY UTILITY
CABINET**
(Aligns with 32" High
Vanity Base Cabinets)

CABINET DIMENSIONS

ROLL TRAY POSITIONS

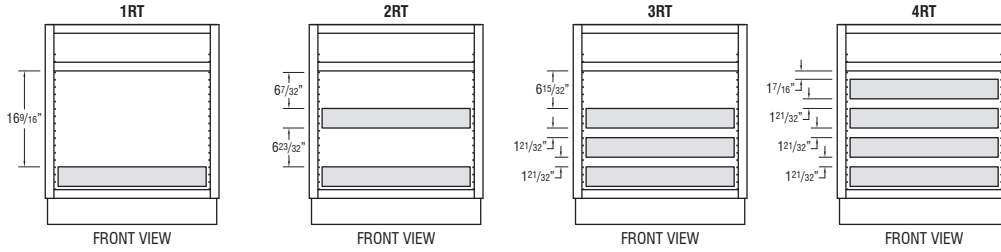

BASE CABINETS AND 34 1/2" HIGH VANITY CABINETS

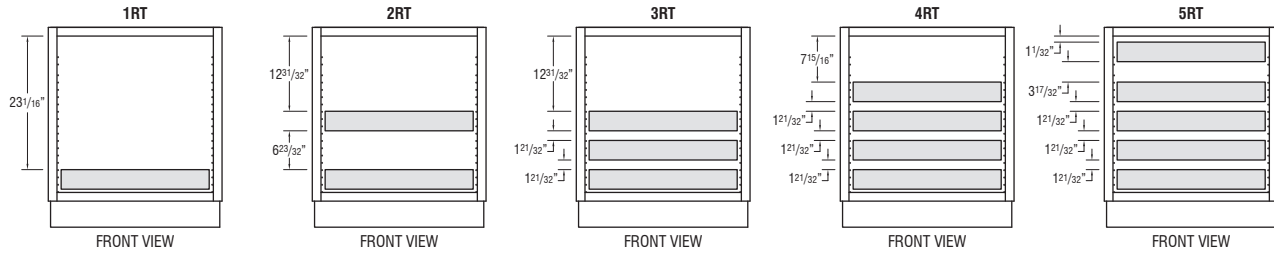

FULL HEIGHT BASE CABINETS

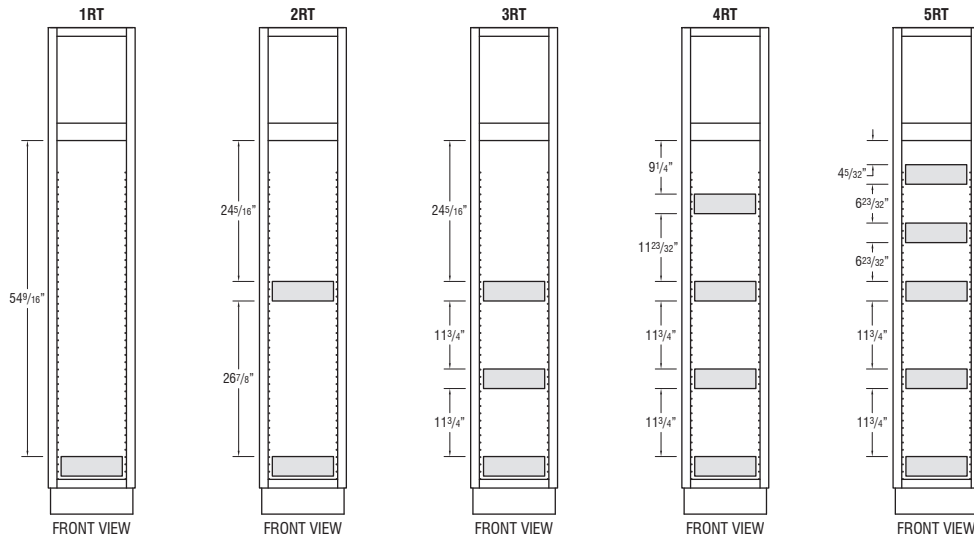

UTILITY CABINETS

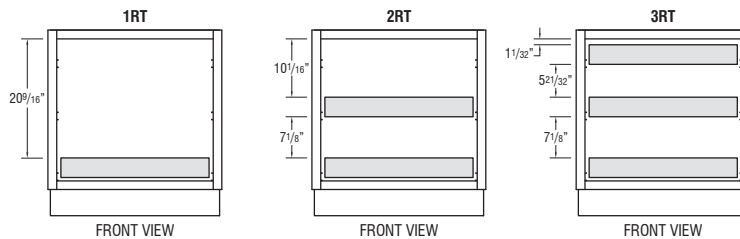

32" HIGH VANITY CABINETS

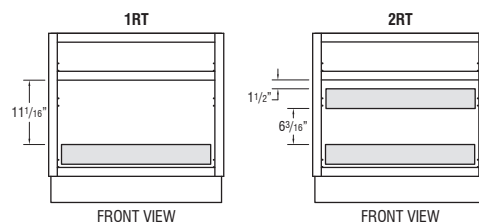

DESK DOOR DRAWER BASE CABINETS

CABINET DIMENSIONS

CABINET AND OVERLAY DIMENSIONS

- 1 1/2" Top and Bottom Rails - Wall and Base Cabinets.
- 1 1/2" Vertical Stiles.
- 3" Center Vertical Rails on Wall and Base Cabinets to Divide Double Door Cabinets 39" Wide and Over.

DOOR AND DRAWER FRONT SIZES	FULL OVERLAY	PARTIAL OVERLAY
Face Frame Reveal (see Overlay Specifications page for more details)	1/4" Reveal Around Doors	1" Reveal Around Doors
Door Size for Base/Wall Cabinets	Frame Opening + 2 1/2"	Frame Opening + 1"
4 1/2" or 5" High Drawer Opening	6 1/4" Drawer Front	5 1/2" Drawer Front
7 1/2" High Drawer Opening	10" Drawer Front	8 1/2" Drawer Front
8 5/8" High Drawer Opening	11 3/8" Drawer Front	9 7/8" Drawer Front
8 7/8" High Drawer Opening	11 3/8" Drawer Front	10 5/8" Drawer Front
12" High Drawer Opening	14 1/2" Drawer Front	13" Drawer Front
14" High Drawer Opening	16 1/2" Drawer Front	15" Drawer Front

84" HIGH APPLICATION

Number after Wall Cabinet Represents Height of Cabinet

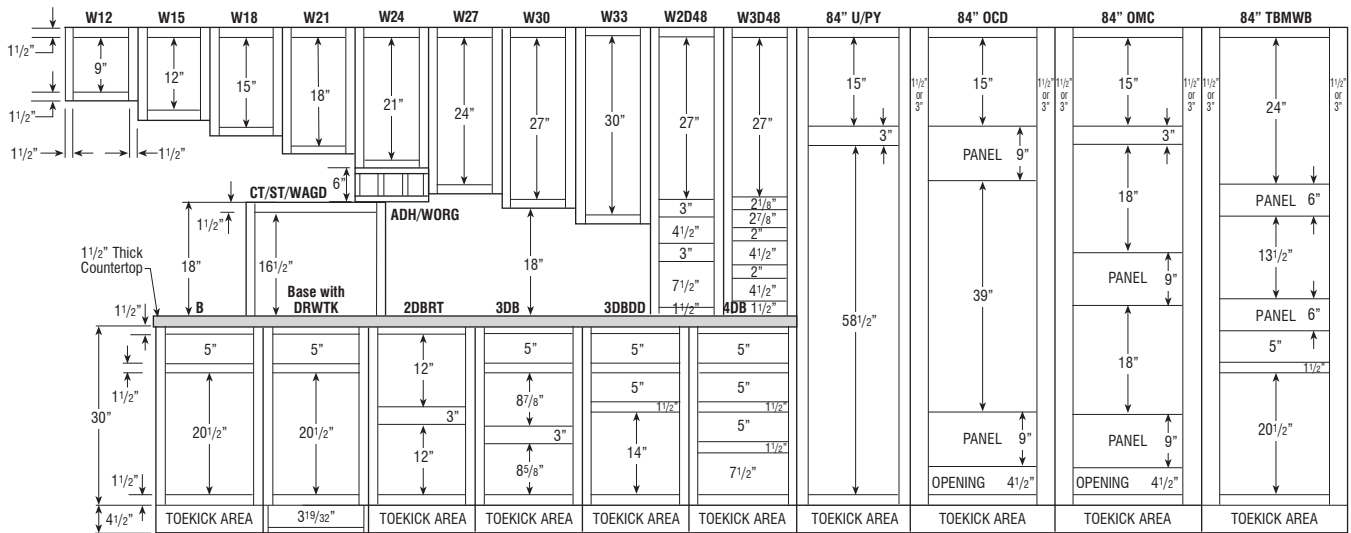

CABINET DIMENSIONS

87" HIGH APPLICATION

Number after Wall Cabinet Represents Height of Cabinet

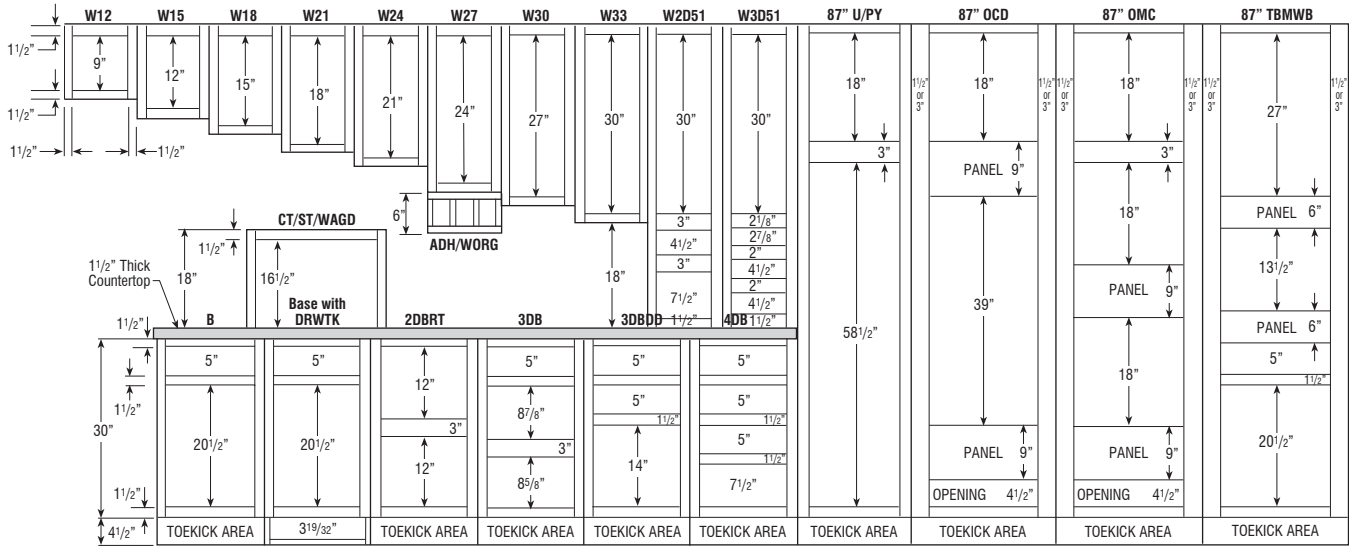

90" HIGH APPLICATION

Number after Wall Cabinet Represents Height of Cabinet

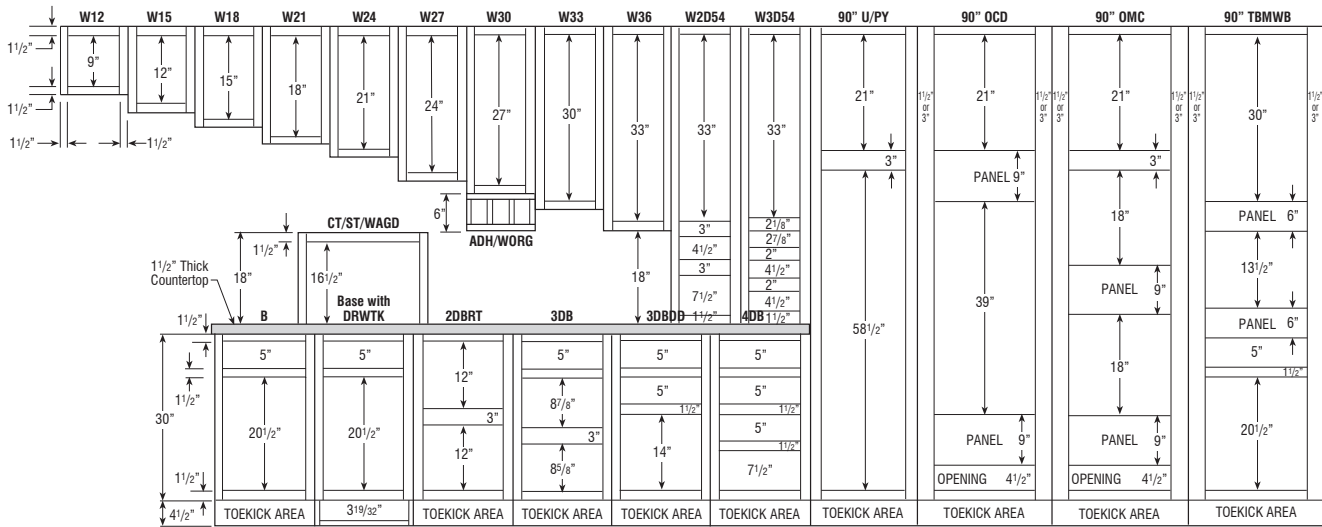

CABINET DIMENSIONS

93" HIGH APPLICATION

Number after Wall Cabinet Represents Height of Cabinet

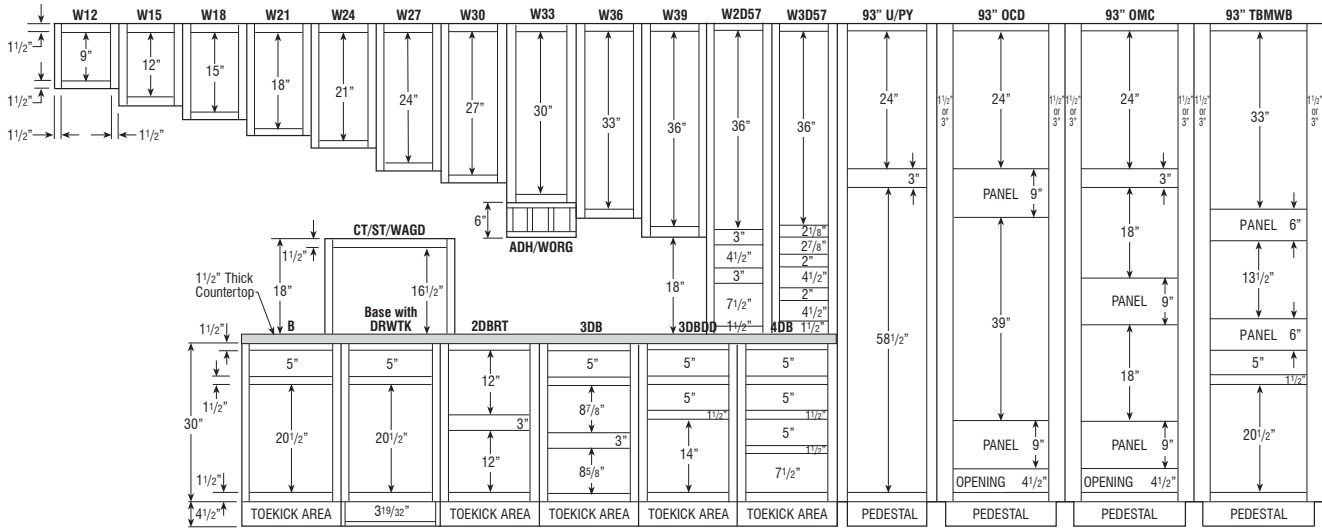

96" HIGH APPLICATION

Number after Wall Cabinet Represents Height of Cabinet

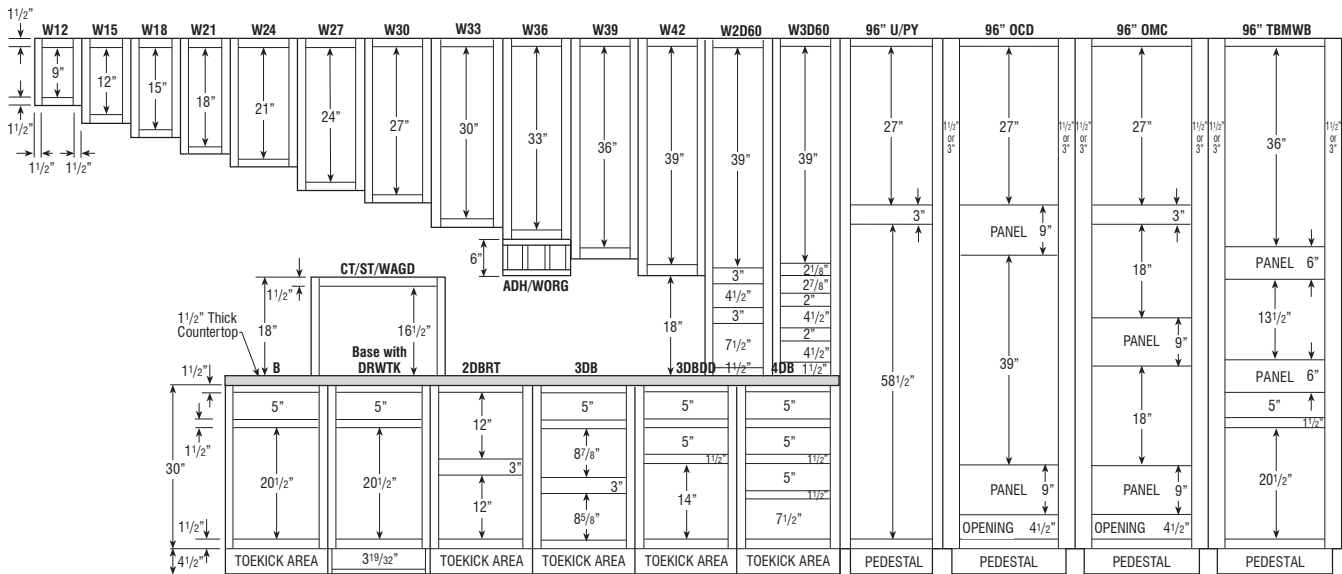

CABINET DIMENSIONS

32 1/2" HIGH UNIVERSAL ACCESS CABINETS, 24" DEEP

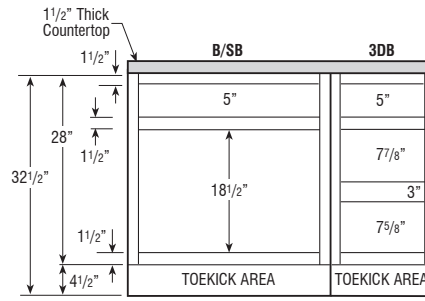

32" HIGH UNIVERSAL ACCESS CABINETS, 21" DEEP

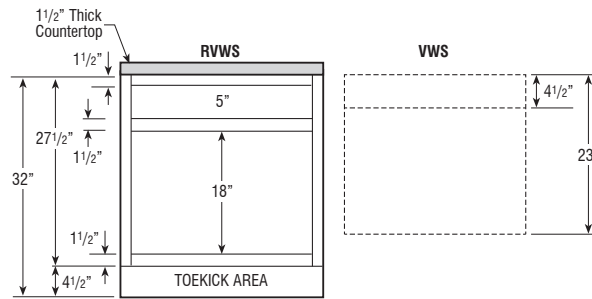

RVWS must be ordered with Vanity Wall Sink (VWS..23), not designed to be a stand-alone unit. See page 174 for more details.

CABINET DIMENSIONS

29" HIGH DESK CABINETS

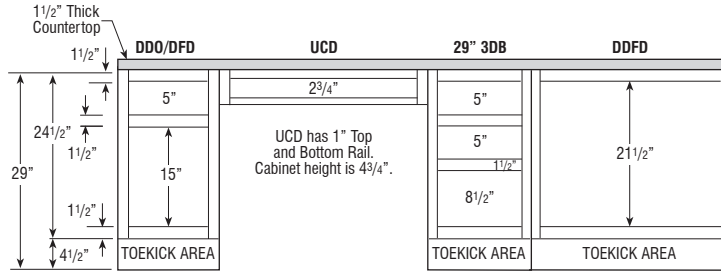

32" HIGH VANITY CABINETS

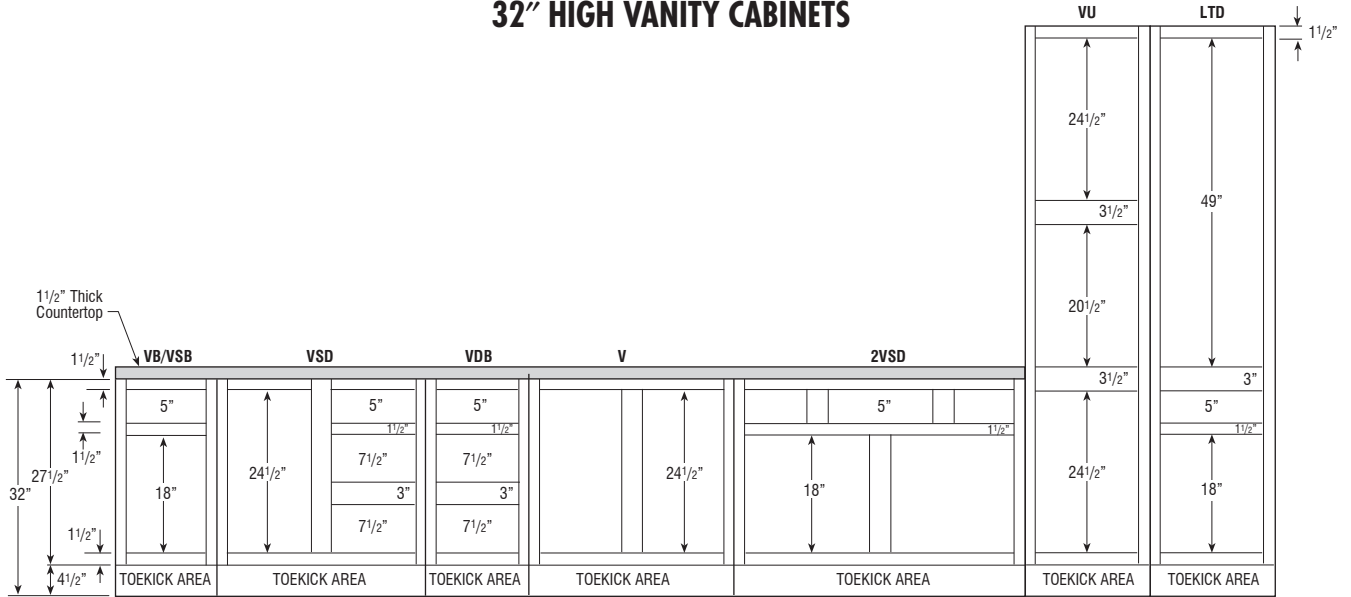

34 1/2" HIGH VANITY CABINETS

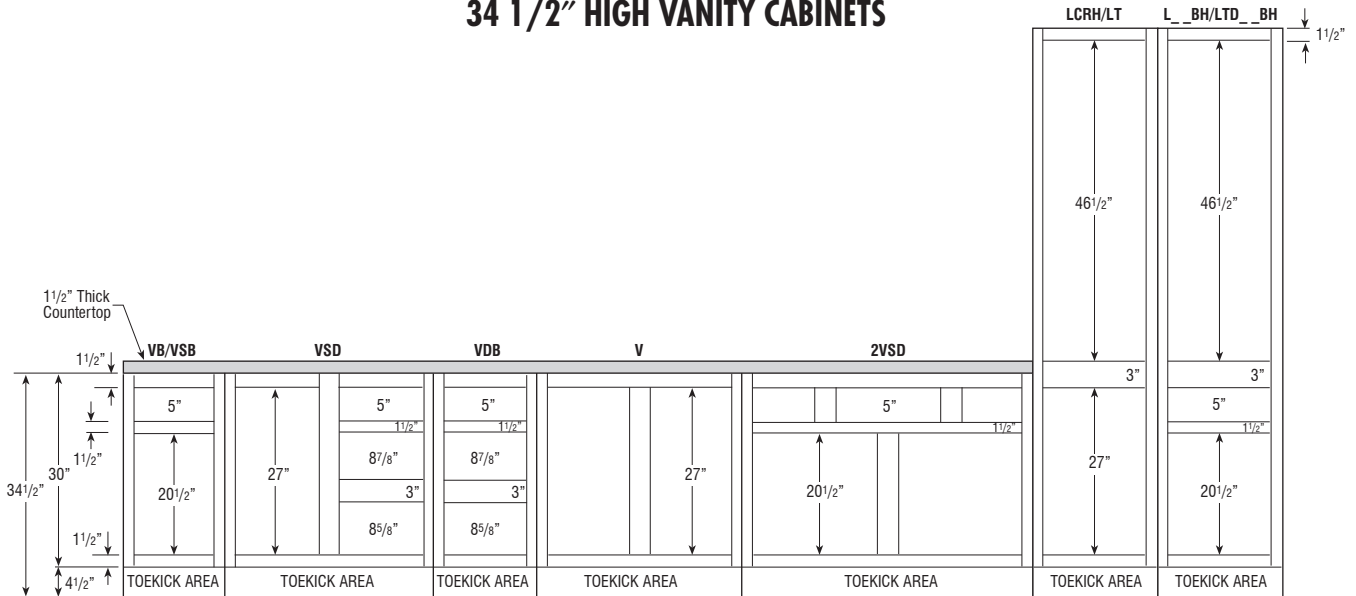

CABINET DIMENSIONS

DIMENSIONS FOR CORNER INSTALLATIONS (45° DIAGONAL)

12" DEEP CABINETS

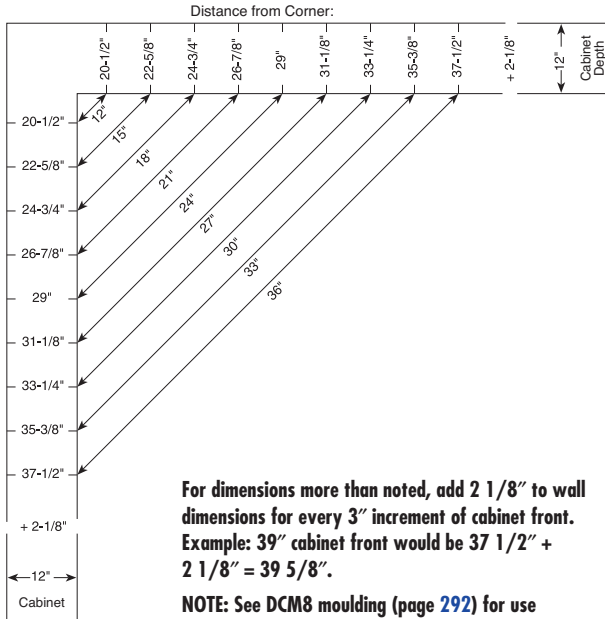

For dimensions more than noted, add 2 1/8" to wall dimensions for every 3" increment of cabinet front.
Example: 39" cabinet front would be 37 1/2" + 2 1/8" = 39 5/8".

NOTE: See DCM8 moulding (page 292) for use between cabinets adjacent to 45° corner installations.

24" DEEP CABINETS

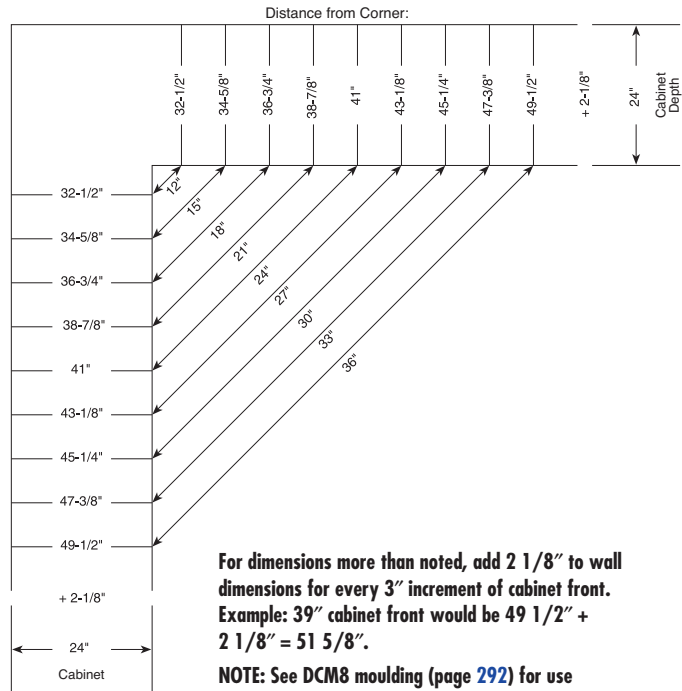

For dimensions more than noted, add 2 1/8" to wall dimensions for every 3" increment of cabinet front.
Example: 39" cabinet front would be 49 1/2" + 2 1/8" = 51 5/8".

NOTE: See DCM8 moulding (page 292) for use between cabinets adjacent to 45° corner installations.

INSTALLATION HEIGHT REQUIREMENTS

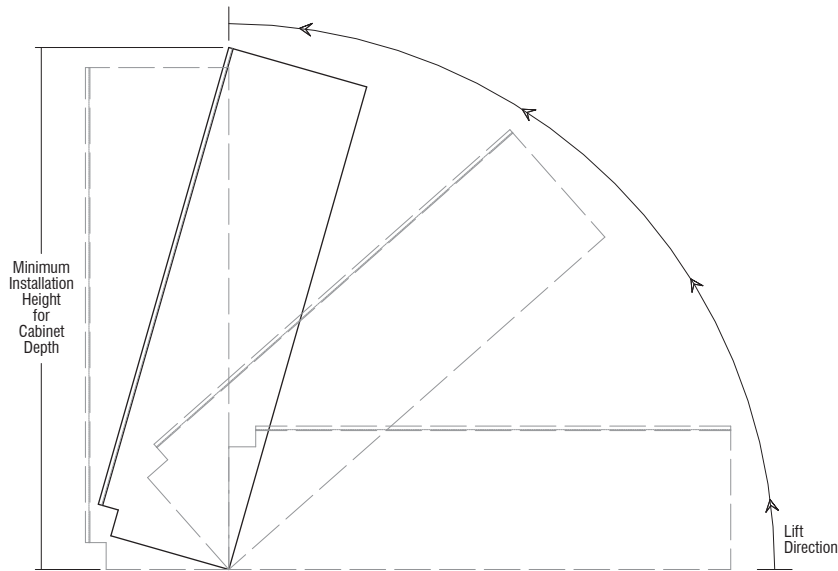

Height of ceiling needs to be considered for installation of tall cabinets. Cabinet height below includes toekick area:

Cabinet Height	Minimum Installation Height for Cabinet Depth					
	12"	15"	18"	21"	24"	27"
84"	84 7/8"	85 11/32"	85 15/16"	86 19/32"	87 3/8"	88 1/4"
87"	87 27/32"	88 5/16"	88 27/32"	89 1/2"	90 1/4"	91 3/32"
90"	90 13/16"	91 1/4"	91 13/16"	92 7/16"	93 5/32"	93 31/32"
93" *	89 5/16"	89 25/32"	90 5/16"	90 31/32"	91 23/32"	92 17/32"
96" *	92 5/16"	92 3/4"	93 9/32"	93 29/32"	94 5/8"	95 13/32"
93" PWT..	—	—	—	95 11/32"	96 1/16"	96 27/32"
96" PWT..	—	—	—	98 9/32"	98 31/32"	99 3/4"

*Separate pedestal base included with cabinet to be installed after cabinet is in an upright position.

DESIGN CHECKLIST

CONSTRUCTION OPTIONS

Consider exposed end options:

- Modify exposed cabinet ends to PE or APC.
- Adding a veneer finished end (FB) will age uniformly with the rest of the kitchen.
- Apply 1/4" skin to hide 1/4" reveal. This will allow the ends to age uniformly with the rest of the kitchen and will make it flush.
- Apply decorative door kit (BED, WED, TED). This kit includes 1/4" skin, decorative doors, and screws for field installation.
- Upgrade exposed cabinet ends with Authentic Ends (AUTHL/AUTHR/AUTHB) or Furniture Finished Plywood Ends (FPPEB) Modification.

WOOD AND FINISH CHARACTERISTICS

Review specific details with the customer:

- Mineral Streaks, Birdseye Dots, Grain Variations (especially Rustic Alder and Rustic Hickory).
- Color Variations/Darkening (especially Natural/Light Cherry).
- Finish Variations (Glazes are "consistently inconsistent"), hairline cracks may develop at frame joints on painted frame.
- Underside of cabinets are Natural Maple. Use light rail or cabinet panel edge and skin to hide, especially when designing with peninsula wall cabinets. For cabinets that are bridged between taller adjacent cabinets, specify PFINBTMB modification. See page 12 for more details.

INNOVATIVE OPTIONS

Review storage and usage needs with Customer. See page 48 for complete chart.

- Cooking Solutions:
 - Wall Spice Rack Cabinet
- Storage Solutions:
 - SuperCabinet™
 - Base Rotating Deep Bin
 - Pegged Dish Organizer
 - Wall Message Center
- Clean-up Center:
 - Trash/Recycle Basket Base

CLEARANCES

- Add fillers between end cabinets and walls on full overlay door styles.
- Allow space between door/window trim and end cabinets for countertop and top moulding overhang.
- Include refrigerator door hinges in overall refrigerator height when placing cabinets above it.

Maintain a minimum clearance of 3" by pulling blind corners as follows:

- Full Overlay: 1 1/4", Standard Overlay 1/2". (More is needed in certain situations such as when adjacent to an appliance or when using oversized pulls or knobs.)
- Allow sufficient clearance (3") on each side of accessory cabinets (such as roll-out trays, swing-out units, etc.). Doors on these cabinets must open fully for accessories to be functional.
- Ensure the height between the cooktop and range hood is 24" to meet NKBA guidelines.

Qualify customer carefully on upper cabinet/microwave advantages/disadvantages as follows:

- Minimum of 18" from cooktop to upper cabinet/above the range microwave which allows for easy access to either, but less room over back burner.
- Minimum of 21" from cooktop to upper cabinet/microwave which allows for access to large pots on back burner of cooktop, but longer reach to microwave.

FILLERS

- Place fillers toward end of run where least conspicuous if needed.
- Attach overlay fillers on top of the base, wall, or tall fillers when using full overlay door styles to maintain a consistent reveal. Don't forget to include blind corner fillers.
- Add a filler at least 6" wide to accommodate a decorative onlay when the filler is used as valance.

VARYING HEIGHTS AND DEPTHS

- Also increase the depth of a wall cabinet run when you increase the height (so moulding on adjacent cabinet will kill into the side of the taller cabinet).
- Skin the sides of tall cabinets to keep adjacent base and wall cabinets out from reveal of tall cabinet.
- Add increased depth on tall end panels for a built-in look for deep refrigerators.
- Account for the additional support needed for wall cabinets with a depth of 18" or greater. This can be achieved by installing a soffit or end panels.

MATCHING INTERIOR CABINETS/GLASS OPTIONS

- Verify cut-for-glass or mullion door option is available on desired cabinet size. (See pages 25-28 for available cut-for-glass/mullion door sizes.)
- Verify glass insert option is available for desired cut-for-glass door size chosen.
- Verify matching interior option has been selected for all open or glass cabinets.
- Verify mullion door lite grid matches customer expectations.

MOULDINGS

- Order rosettes and plinths in beaded or fluted styles to match fillers.
- Verify correct amount of crown moulding has been ordered.
- Order toekick caps.
- Order extra scribe.

ISLANDS AND PENINSULAS

- Consider standard height bars are 34 1/2" tall and require 19" knee space. Raised bars are 42" tall.
- Consider base peninsula cabinets (P) are 24 1/4" deep and require 12" of knee space. Use back panels/doors to flush non-P cabinets with P cabinets.
- Use recess toe on sides and back or BBM8 when using multiple base cabinets to create an island.
- Use outside corner moulding if a skin is exposed on the back of the island.

APPLIANCES

- Note for all consumers, appliances are not included with any cabinetry product.
- Do not place dishwashers next to diagonal front cabinet (interference) or next to a range (no countertop support).
- Verify refrigerator door has enough clearance to open beyond 90° so refrigerator drawers can be utilized. Refer to appliance manufacturer's specs.
- Add TF696FH, as it may be required to frame around built-in microwave ovens and other built-in items. Refer to appliance manufacturer's specs.
- Order appliance panels.

SPECIAL CONSIDERATIONS

- Consider V-groove skins and/or decorative doors on exposed cabinet sides in glazed kitchen.

MISCELLANEOUS

- Order full size touch-up kit (mini touch-up kit included with standard sink base).

TIPS TO THE INSTALLER

Proper wall stud or ceiling joist installation is essential for Wall and Peninsula cabinets to support weight. Whenever possible, cabinets should be attached to each other for additional strength. Excessive weight should not be put on cabinets hung by themselves. Shimming may be required to ensure proper alignment. Wallboard alone is not strong enough to support the cabinets.

Our Warranty does not cover damage caused by improper installation. Please be sure to install cabinets properly. If you have questions, please contact your representative or customer service.

kitchen planning guidelines

46

DOOR/ENTRY

- Door opening should be at least 32" wide, requiring a minimum 2' 10" wide door.

DOOR INTERFERENCE

- Entry door should not interfere with safe appliance operation or appliance doors.

DISTANCE BETWEEN WORK CENTERS

- With three work centers, the total distance traveled should not be more than 26' with no single leg of the triangle less than 4' or more than 9'.
- With more than three work centers, each additional travel distance to another work center should be no less than 4' or more than 9'. Each leg is measured from the center-front of the appliance/sink. No work triangle leg should intersect an island/peninsula by more than 12".

SEPARATING WORK CENTERS

- A tall obstacle should not separate two primary work centers. A properly recessed tall corner unit is acceptable.

WORK TRIANGLE TRAFFIC

- Major traffic patterns should not cross through the basic work triangle.

WORK AISLE

- The work aisle should be at least 42" for one cook and at least 48" for multiple cooks.

WALKWAY

- The walkway width should be at least 36".

TRAFFIC CLEARANCE AT SEATING

- Allow 32" of clearance from the table to wall/obstacle if no traffic passes behind a seated diner. If traffic passes behind the diner, allow at least 36" to edge past or 44" to walk past.

SEATING CLEARANCE

- 30" high tables/counters should allow a 24" wide by 18" deep space for each seated diner and at least 18" knee space.
- 36" high counters should allow a 24" wide by 15" deep space for each seated diner and at least 15" kneespace.
- 42" high counters should allow a 24" wide by 12" deep space for each seated diner and at least 12" kneespace.

CLEAN-UP/PREP SINK PLACEMENT

- With only one sink, locate it adjacent to or across from the cooking surface and refrigerator.

CLEAN-UP/PREP SINK LANDING AREA

- Include at least a 24" wide landing space on one side of the sink and 18" on the other.
- If all the countertop at the sink is not the same height, plan a 24" landing space on one side of the sink and 3" of countertop frontage on the other, both at the same height of the sink.

PREPARATION/WORK AREA

- Include a section of countertop at least 36" wide x 24" deep next to the sink for a work area.

DISHWASHER PLACEMENT

- Nearest edge of dishwasher should be within 36" of nearest edge of sink. Provide at least 21" of standing space between the edge of the dishwasher and countertop frontage/appliances/cabinets which are placed at a right angle to the dishwasher.

WASTE RECEPTACLES

- Include at least 2 waste receptacles, one near the sink and the other nearby for recycling.

AUXILIARY SINK

- Provide at least 3" of countertop frontage on one side of the auxiliary sink and 18" on the other side, both at the same height as the sink.

REFRIGERATOR LANDING AREA

- Include at least 15" of landing area on the handle side of the refrigerator, 15" on either side of a side-by-side refrigerator, 15" of landing space which is no more than 48" across from the front of the refrigerator, and 15" above or adjacent to any under-counter style refrigerator.

COOKING SURFACE LANDING AREA

- Include a minimum of 12" of landing area on one side of the cooking surface and 15" on the other.
- If cooking surface is at a different countertop height than the rest of the kitchen, then the 12" and 15" landing areas must be the same height as the cooking surface.
- For safety reasons, in an island or peninsula situation, the countertop should extend a minimum of 9" behind the cooking surface if the counter height is the same height as the cooking surface.

COOKING SURFACE CLEARANCE

- Allow 24" between the cooking surface and a protected noncombustible surface above it.
- At least 30" of clearance is required between the cooking surface and an unprotected/combustible surface above it.
- If a microwave/hood combination is used, then the manufacturer's specifications should be followed.

COOKING SURFACE VENTILATION

- A correctly sized, ducted ventilation system is recommended for all cooking surface appliances. The recommended minimum is 150 CFM.
- Code requires that the manufacturer's specifications be followed. Minimum exhaust rate for a ducted hood is 100 CFM and must be ducted to the outside.
- Make-up air may need to be provided. Refer to local codes.

COOKING SURFACE SAFETY

- Do not locate cooking surface under an operable window.
- Window treatments above cooking surface should not use flammable materials.
- Place a fire extinguisher near the kitchen exit away from cooking equipment.

MICROWAVE OVEN PLACEMENT

- The ideal location for the bottom of the microwave is 3" below the principle user's shoulder, but no more than 54" above the floor.

MICROWAVE LANDING AREA

- Provide at least 15" above, below, or adjacent to the handle side of a microwave oven.

OVEN LANDING AREA

- Include at least 15" next to or above the oven.
- A 15" landing area that is not more than 48" away is also acceptable as long as the oven does not open into a walkway.

COMBINING LANDING AREAS

- If two landing areas are adjacent to one another, determine a new minimum for the two by taking the longer of the two and adding 12".

continued

kitchen planning guidelines (continued)

COUNTERTOP SPACE

- A total of 158" of countertop frontage, 24" deep, with at least 15" clearance above is needed to accommodate all landing, preparation, work, and storage areas.

COUNTERTOP EDGES

- Clipped or round corners, rather than sharp edges, are recommended on all counters.

STORAGE

- The recommended total shelf/drawer frontage for a small kitchen (less than 150 square feet) is 1400", for a medium kitchen (151 to 350 square feet) is 1700", and for a large kitchen (greater than 350 square feet) is 2000".

Sizes:	S	M	L
Wall	300"	360"	360"
Base	520"	615"	660"
Drawer	360"	400"	525"
Pantry	180"	230"	310"
Misc.	40"	95"	145"

- The totals for wall, base, drawer, and pantry shelf/drawer frontage can be adjusted upward or downward as long as the recommended total stays the same.

STORAGE AT CLEAN-UP/PREP SINK

- The recommended total for a small kitchen is 400", a medium kitchen is 480", a large kitchen is 560", and should be located within 72" of the centerline of the main clean-up/prep sink.

CORNER CABINET STORAGE

- At least one corner cabinet should include a functional storage device.

ELECTRICAL RECEPTACLES

- GFCI (Ground-Fault-Circuit-Interrupter) protection is required on all receptacles servicing countertop surfaces within the kitchen.

LIGHTING

- Every work surface should be well illuminated. At least one wall switch-controlled light must be placed at the entrance.
- Window/skylight area, equal to at least 8% of the total square footage of the kitchen, or a total living space which includes a kitchen, is required.

bathroom planning guidelines

DOOR/ENTRY

- Doorway opening should be at least 32", requiring a minimum 2' 10" wide door.

DOOR INTERFERENCE

- The door area should include clear floor space for maneuvering which varies according to the type of door and the direction of the approach.

CEILING HEIGHT

- Bathroom floor to ceiling minimum height is 80". A shower or tub with a shower head shall have a minimum floor to ceiling height of 80" above a minimum area 30" x 30" at the shower head.

CLEAR SPACE

- Plan a clear space of 30" from the front edge of all fixtures to any opposite bath fixture, wall, or obstacle.
- A minimum space of at least 21" is required in front of a lavatory, toilet, bidet, and tub, with a 24" minimum space in front of a shower entry.

SINGLE LAVATORY PLACEMENT

- The distance from the centerline of the lavatory to the sidewall/tall obstacle should be at least 20".
- The minimum distance required is 15". The minimum distance required between a wall and the edge of a lavatory is 4".

DOUBLE LAVATORY PLACEMENT

- The distance between the centerlines of two lavatories should be at least 36".
- The minimum distance required is 30".
- The minimum distance required between the edges of two lavatories is 4".

LAVATORY/VANITY HEIGHT

- The height for a lavatory varies from 32" to 43" to fit the user.

COUNTERTOP EDGES

- Clipped or round corners, rather than sharp edges, are recommended on all counters.

SHOWER SIZE

- The interior shower size should be at least 36" x 36". The minimum interior shower size required is 30" x 30".

STORAGE

- Provide adequate, accessible storage for toiletries, bath linens, grooming and general bathroom supplies.
- Storage of frequently used items should be 15" to 48" above floor.

ELECTRICAL RECEPTACLES

- All GFCI receptacles should be located at electrical appliance points of use.

Load bearing floors and shelves can support 15 lbs. per square foot. Warranty does not cover overloading beyond this point.

To view a complete and updated list of the NKBA Guidelines, visit <https://nkba.org/info/guidelines>

© Copyright 2010 National Kitchen & Bath Association

INNOVATIVE OPTIONS REFERENCE CHART

48

INNOVATIVE OPTIONS REFERENCE CHART

Wall Cabinets	Description	3"	6"	9"	12"	15"	18"	21"	24"	27"	30"	33"	36"	39"	42"	45"	48"	Page
W36__SHLFPD	Wall Shelf Pull-down																	98
WBCPO____, OL	Wall Box Column Pull-outs (Plain, Overlay)	•	•															96, 97
WMC_____	Wall Message Center	•																101
WSC_____	Wine Storage Cabinet				•	•	•	•										99
WSP_____	Wall Spice Pull-outs			•	•													97
WSR_____	Wall Spice Rack Cabinets						•	•										98
Base Cabinets	Description	3"	6"	9"	12"	15"	18"	21"	24"	27"	30"	33"	36"	39"	42"	45"	48"	Page
2DB__RT	Two Drawer Bases w/Roll Tray						•	•	•	•	•	•	•					154
2DB36PDO	Two Drawer Base w/Pegged Dish Organizer												•					154
2DB36RTPDO	Two Drawer Base w/Roll Tray & Pegged Dish Organizer												•					154
3DB__WTC	Three Drawer Bases w/Wood Tiered Cutlery Divider Drawer					•	•	•	•		•	•						156
3DBBD__	Three Drawer Base Buffet w/Deep Drawer										•	•						157
3DBD__	Three Drawer Bases w/Deep Drawer								•	•	•	•						157
4DB__WTC	Four Drawer Bases w/Wood Tiered Cutlery Divider Drawer					•	•	•	•		•	•						158
B__FHMIXSC	Base Cabinets w/Mixer Shelf						•	•	•									127
B__FSCO	Base w/Food Storage Container Organizer						•	•										124
B__PS	Pots & Pans Organizer Bases w/Drawer								•		•	•						123
B__RTWTC	Bases w/Wood Tiered Cutlery Divider Drawer & Roll Tray					•	•	•	•		•	•						122
B__TDRO	Bases with Roll-out Tray Divider				•	•												126
B__WTC	Bases w/Wood Tiered Cutlery Divider Drawer					•	•	•	•		•	•						114
B18CWP18	Base w/Can and Wine Bottle Pull-outs						•											125
B18HCWP18	Full Height Base w/Can and Wine Bottle Pull-outs						•											125
BBCPO__, OL	Base Box Column Pull-outs (Plain, Overlay)	•	•															164
BC__PO	Base Corners w/Pull-out															•	•	141
BCFW__PO	Base Corners Full Width w/Pull-out															•	•	142
BCFW4BCPO	Base Corner Full Width w/Curved Pull-out																•	142
BCFW48SP	Base Corner Full Width w/Roll Trays & Swing-out																•	143
BCOPP12	Base Container Organizer Pantry Pull-out				•													163
BMC24	Base Message Center	•																165
BPP__	Base Pantry Pull-outs			•	•													162
BPPP__	Base Pots & Pans Pull-outs								•		•							123, 124
BPT__WB	Base Paper Towel Cabinet w/Wastebasket					•	•											159
BPT__WBFH	Base Paper Towel Cabinet w/Wastebasket Full Height					•	•											161
BRDB36	Base Rotating Deep Bin												•					150
BSC30__	SuperCabinet™											•						118
BSC36__	SuperCabinet™												•					119
BDPP12	Base Tray Divider Pantry Pull-out				•													163
BUPP__	Base Utensil Pantry Pull-out			•	•													163
BUPPKB__	Base Utensil Pantry Pull-out w/Knife Block			•	•													164
BWB__	Base Wastebaskets					•	•	•										159
BWB__FH	Base Wastebaskets Full Height					•	•	•										160
CNTYSB__CM	Country Sink Base w/CabMat™										•	•	•					136
LSP36	Lazy Susan Pull-out												•					150
SB__CM, SCM, STCM, STSCM	Sink Base w/CabMat™										•	•	•					128, 131, 132, 133
SB__D	Sink Bases w/Drawers Below								•	•	•	•	•	•	•	•	•	133
SB__S	Sink Base SuperCabinet™										•	•	•					132
SB__STS	Sink Base SuperCabinet™ w/Tilt-out Trays										•	•	•					132
SLSR__	Super Lazy Susans w/Chrome Rail												•	•				148
SLSR____	Asymmetrical Super Lazy Susans w/Chrome Rail												•	•				149
Tall Cabinets	Description	3"	6"	9"	12"	15"	18"	21"	24"	27"	30"	33"	36"	39"	42"	45"	48"	Page
PTU____24	Pantry Top Units					•	•	•	•		•	•						187
PY36__24	Pantry Units												•					189
TPP____24	Tall Pantry Pull-outs			•	•	•	•											188
UOC24__6	Utility Organizer Cabinet		•															184
UOCD24__9	Utility Organizer Drop Zone Cabinet								•									185
Vanity Cabinets	Description	3"	6"	9"	12"	15"	18"	21"	24"	27"	30"	33"	36"	39"	42"	45"	48"	Page
L188421BH	Linen Tall w/Drawer and Removable Hamper						•											249
LCRH188421	Linen Closet w/Removable Hamper						•											248
VBH183421	Vanity Hamper w/Drawer						•											247
VBWB153421	Vanity Base Wastebasket					•												235
VGPO123421	Vanity Grooming Pull-out				•													236
VH183221FH	Vanity Hamper						•											247
VP93421	Vanity Pull-out			•														236
VSBB__21U	Vanity Sink Bases w/U-shaped Pull-out Trays										•	•						231
VSSB__3421ST	Vanity Sink Base SuperCabinet™ w/Tilt-out Trays										•	•	•					231
VWB15__21	Vanity Wastebasket Full Height					•												235
VWB15__21RT	Vanity Wastebasket Full Height w/Roll Tray					•												235, 236
VWH__23.521U	Vanity Wall Hung Double Door w/U-shaped Pull-outs										•	•						251
Modifications	Description	3"	6"	9"	12"	15"	18"	21"	24"	27"	30"	33"	36"	39"	42"	45"	48"	Page
CMAT1 (Base, Universal)	CabMat™										•	•	•					15
CMAT2 (Vanity)	CabMat™								•	•	•	•	•					15
DRWTK	Toekick Drawer						•	•	•	•	•	•	•					22

• Available widths

TABLE OF CONTENTS – WALL CABINETS

Wall Cabinets 9" High50
Wall Cabinets 12" High51
Wall Cabinets 15" High53
Wall Cabinets 18" High56
Wall Cabinets 21" High60
Wall Cabinets 24" High64
Wall Cabinets 27" High66
Wall Cabinets 30", 33", or 36" High68
Wall Cabinets 39" or 42" High70
Wall Cabinets with Drawers72
Stacked Wall Cabinets75
Wall Corner Cabinets78
Wall Organization and Specialty Cabinets89
Range Hoods101

WALL CABINETS

WALL CABINET NOMENCLATURE

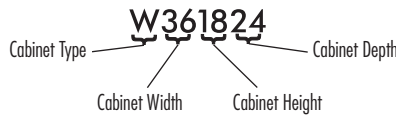

MODIFICATIONS GRID KEY

- Available
- STD Standard on these cabinets
-  5 Day Express Response Item

CONSTRUCTION UPGRADES

Mod.	Description
APC	All-plywood Construction
PE	Plywood Ends

DOOR OPTIONS

Mod.	Description
ALF	Aluminum Frame Doors
CG, CG.BTM, CG.TOP	Cut-for-glass Doors
DPSRR	Door Panel - Solid Reverse Raised
MD, MD.BTM, MD.TOP	Mullion Doors
MFO	Modified Full Overlay

CUSTOM MODIFICATIONS

Mod.	Description	Mod.	Description
ADDTK*	Add Toekick	FB	Finished Ends
AUTHB	Authentic Ends - Both	FFDL	Face Frame and Door on End - Left
AUTHL	Authentic End - Left	FFDR	Face Frame and Door on End - Right
AUTHR	Authentic End - Right	FPEB	Furniture Finished Plywood Ends
CBO	Cabinet Box Only	ID	Increased Depth
CCO	Cabinet Case Only	INVFRM	Inverted Frame
CFNTO	Cabinet Front Only	MIP	Matching Interior Plywood
CFRMO	Cabinet Frame Only	P	Peninsula
CH	Custom Height	PFINBTMB	Prepare Cabinet for Finished Bottom
CND	Cabinet with No Door, with Drawer	RD	Reduced Depth
CW	Custom Width	TD	Tray Dividers
EXBKL	End Extended Back - Left	TVRAV	Valance Top Rail, Arch
EXBKR	End Extended Back - Right	TVRFV	Valance Top Rail, Furniture
EXL	Extended Stile - Left	TVRVV	Valance Top Rail, Straight
EXR	Extended Stile - Right		

*ADDTK available with compatible toekick modifications.
See the Modification/Upgrade Compatibility Chart on page 2 for details.

All Wall Cabinets are 12" deep unless otherwise noted.

When varying heights, make sure to also vary depths to allow moulding to end against adjacent side of cabinet.

Use space fillers where needed (S96X14) to avoid using skins when varying depths; the fillers are used to make up the 1/4" reveal behind the face frame.

Use FPEB modification or apply an end panel skin to create a flush end on the side of a wall cabinet if installed at the end of a run for ease of moulding installation.

FPEB modification is recommended for non-stacking applications. Use a 1/4" skin for stacking applications.

WALL TOP HINGE, 9" HIGH

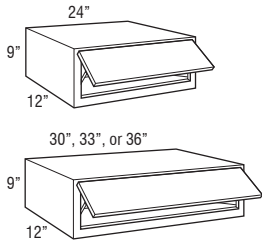

	Price Point	1	2	3	4	5	6	7	8	9	10	11	12
WTH249		544	635	662	689	715	740	782	813	848	876	903	976
WTH309		573	669	697	725	753	780	823	856	893	922	950	1027
WTH339		591	685	715	743	771	799	847	878	914	945	974	1054
WTH369		608	703	732	760	788	816	869	900	935	970	997	1080

- 24" Wide (WTH249) uses standard configuration doors. See Door Style Specifications page in Door Style section for details on doors with grain pattern exceptions.
- 30"-36" Wide (WTH309-WTH369) use non-standard configuration doors. See Door Style Specifications page in Door Style section for details on doors with grain pattern exceptions.
- Not available on all door styles. See Door Style section for exceptions.
- Glass not available.
- Door lift mechanism tension can be field adjusted.
- Depth can be reduced to a minimum of 9".
- Door will open a maximum of 107°. For applications close to a ceiling, door angle can be restricted to 75° with a Wall Top Hinge Restriction Clip (WTHRESCLIP75, see page 320).
- Door will not have standard hinges and may have visible 3/16" diameter holes used during finish processing.
- Lift mechanism not available for order for field installation, only available factory installed.

Custom Modifications

ADDTK	AUTH	CBO	CCO	CFNTO	CFRMO	CH	CND	CW	EXBK	EX	FB	FFD	FPEB	ID	INVFRM	MIP	P	PFINBTMB	RD	TD	TVR_V	
			•					•	•	•				•					•			

Construction Upgrades

APC	PE
•	•

Door Options

ALF	CG	CG.BTM	CG.TOP	DPSRR	MD	MD.BTM	MD.TOP	MFO
				•				

WALL TOP HINGE REFRIGERATOR, 9" HIGH, 24" DEEP

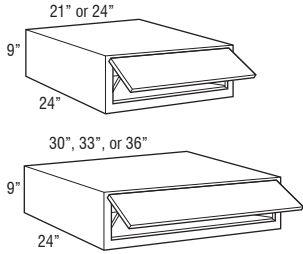

WTH21924	688	803	837	869	903	935	989	1027	1071	1105	1140	1232
WTH24924	702	820	853	887	922	955	1009	1048	1093	1129	1164	1258
WTH30924	717	836	870	905	940	974	1029	1070	1116	1151	1187	1284
WTH33924	739	857	893	927	963	998	1058	1099	1144	1183	1217	1317
WTH36924	760	878	914	950	986	1021	1085	1126	1169	1212	1247	1351

- 21"-24" Wide (WTH21924-WTH24924) use standard configuration doors. See Door Style Specifications page in Door Style section for details on doors with grain pattern exceptions.
- 30"-36" Wide (WTH30924-WTH36924) use non-standard configuration doors. See Door Style Specifications page in Door Style section for details on doors with grain pattern exceptions.
- Not available on all door styles. See Door Style section for exceptions.
- 24" deep cabinets must be fully supported by screws installed in a structural member in the ceiling or soffit, and into adjacent cabinets or tall panels.
- Load limit is 15 lbs. per square foot of load bearing surface.
- Glass not available.
- Two WTH21924 can be used to create a 42" wide solution for wide refrigerator applications.
- Two WTH24924 can be used to create a 48" wide solution for wide refrigerator applications.
- Door lift mechanism tension can be field adjusted.
- Depth can be reduced to a minimum of 9".
- Door will open a maximum of 107°. For applications close to a ceiling, door angle can be restricted to 75° with a Wall Top Hinge Restriction Clip (WTHRESCLIP75, see page 320).
- Door will not have standard hinges and may have visible 3/16" diameter holes used during finish processing.
- Lift mechanism not available for order for field installation, only available factory installed.

Custom Modifications

ADDTK	AUTH	CBO	CCO	CFNTO	CFRMO	CH	CND	CW	EXBK	EX	FB	FFD	FPEB	ID	INVFRM	MIP	P	PFINBTMB	RD	TD	TVR_V	
			•					• ¹	•	•				•					•			

Construction Upgrades

APC	PE
•	•

Door Options

ALF	CG	CG.BTM	CG.TOP	DPSRR	MD	MD.BTM	MD.TOP	MFO
				•				

¹ Not available on 21" wide

WALL SINGLE DOOR, 12" HIGH

12", 15", 18", 21", or 24"

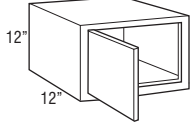

	Price Point	1	2	3	4	5	6	7	8	9	10	11	12
W1212 L or R		388	451	469	486	503	520	553	571	597	615	634	688
W1512 L or R		412	476	495	513	532	550	585	606	632	652	671	728
W1812 L or R		436	505	525	545	566	585	619	643	669	693	713	773
W2112 L or R		451	528	549	569	589	609	647	668	713	725	746	805
W2412 L or R		470	554	577	598	620	642	680	697	730	764	783	849

Custom Modifications

ADDTK	AUTH	CBO	CCO	CFNTO	CFRMO	CH	CND	CW	EXBK	EX	FB	FFD	FPEB	ID	INVFRM	MIP	P	PFINBTMB	RD	TD	TVR_V	
• ¹	•		•	•	•			• ²	•	•	•		•	•		•	•	•	•			

Construction Upgrades

APC	PE
•	•

Door Options

ALF	CG	CG.BTM	CG.TOP	DPSRR	MD	MD.BTM	MD.TOP	MFO
• ³	•			•				•

¹ Not available on 21" and 24" wide

² Not available on 12" wide

³ Not available on 12", 21", and 24" wide

WALL DOUBLE DOOR, 12" HIGH

24", 27", 30", 31 1/2", 33", 34", 36", or 37"

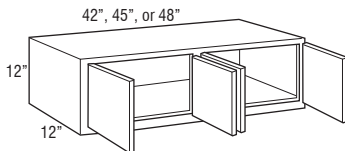
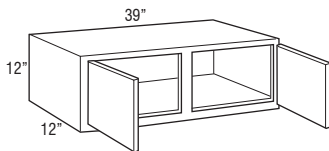
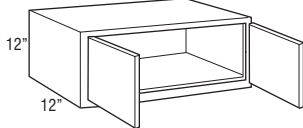

W2412	474	559	581	604	626	648	688	704	739	772	792	857
W2712	483	566	589	612	635	657	697	720	767	781	802	868
W3012	491	573	597	619	643	665	704	735	762	791	812	879
W31.512	498	581	606	628	652	675	715	745	773	801	823	893
W3312	506	589	614	637	661	684	725	754	784	810	833	906
W3412	514	596	620	645	670	693	734	763	792	821	846	915
W3612	519	599	625	650	674	699	744	772	803	831	853	924
W3712	530	612	637	662	687	711	756	786	816	847	870	941

W3912	539	620	646	672	698	724	768	800	832	861	885	960
--------------	-----	-----	-----	-----	-----	-----	-----	-----	-----	-----	-----	-----

W4212	576	657	684	711	738	764	806	839	875	908	930	1009
W4512	632	724	753	782	811	839	887	924	964	999	1023	1111
W4812	699	795	828	860	893	924	977	1018	1060	1098	1127	1222

• 42" or wider will feature four doors.

Custom Modifications

ADDTK	AUTH	CBO	CCO	CFNTO	CFRMO	CH	CND	CW	EXBK	EX	FB	FFD	FPEB	ID	INVFRM	MIP	P	PFINBTMB	RD	TD	TVR_V	
•	•		•	•	•			• ¹	•	•	•		•	•		•	•	•	•			

Construction Upgrades

APC	PE
•	•

Door Options

ALF	CG	CG.BTM	CG.TOP	DPSRR	MD	MD.BTM	MD.TOP	MFO
•	•			•				•

¹ Not available on 42", 45", and 48" wide

WALL TOP HINGE, 12" HIGH

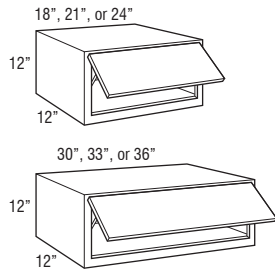

Price Point	1	2	3	4	5	6	7	8	9	10	11	12
WTH1812	557	648	675	702	729	755	799	830	865	893	921	995
WTH2112	561	655	682	709	736	763	806	838	872	902	930	1005
WTH2412	573	670	697	725	752	780	823	855	893	921	950	1026
WTH3012	585	683	711	739	767	795	840	872	911	940	969	1047
WTH3312	603	700	729	757	786	814	864	896	933	965	993	1075
WTH3612	620	717	746	775	804	833	886	918	955	990	1017	1102

- 18"-24" Wide (WTH1812-WTH2412) use standard configuration doors. See Door Style Specifications page in Door Style section for details on doors with grain pattern exceptions.
- 30"-36" Wide (WTH3012-WTH3612) use non-standard configuration doors. See Door Style Specifications page in Door Style section for details on doors with grain pattern exceptions.
- Not available on all door styles. See Door Style section for exceptions.
- Art Glass not available.
- Cabinet may utilize one or two lift mechanisms depending on door size and weight. Door lift mechanism tension can be field adjusted.
- Depth can be reduced to a minimum of 9".
- Door will open a maximum of 107° due to hinges. For applications close to a ceiling, door angle can be restricted to 86° with a Hinge Angle Restriction Clip (HINGERESCLIP, see page 320).
- Lift mechanisms and mounting brackets will be visible if used with transparent textured glass.
- Lift mechanism not available for order for field installation, only available factory installed.

Custom Modifications

ADDTK	AUTH	CBO	CCO	CFNTO	CFRMO	CH	CND	CW	EXBK	EX	FB	FFD	FPEB	ID	INVFRM	MIP	P	PFINBTMB	RD	TD	TVR_V	
	•		•			•	• ¹	• ¹	•	•	•		•	•		•		•	•			

Construction Upgrades

APC	PE
•	•

Door Options

ALF	CG	CG.BTM	CG.TOP	DPSRR	MD	MD.BTM	MD.TOP	MFO
• ²	•			•				•

¹ Not available on 18" wide
² Available only on 30" and 36" wide

WALL REFRIGERATOR SINGLE DOOR, 12" HIGH, 24" DEEP

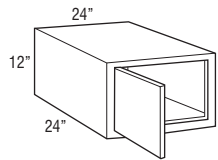

W241224 L or R	568	671	700	729	758	786	834	868	884	934	959	1038
-----------------------	-----	-----	-----	-----	-----	-----	-----	-----	-----	-----	-----	------

- 24" deep cabinets must be fully supported by screws installed in a structural member in the ceiling or soffit, and into adjacent cabinets or tall panels.
- Load limit is 15 lbs. per square foot of load bearing surface.

Custom Modifications

ADDTK	AUTH	CBO	CCO	CFNTO	CFRMO	CH	CND	CW	EXBK	EX	FB	FFD	FPEB	ID	INVFRM	MIP	P	PFINBTMB	RD	TD	TVR_V	
	•		•	•				•	•	•	•		•	•		•		•	•			

Construction Upgrades

APC	PE
•	•

Door Options

ALF	CG	CG.BTM	CG.TOP	DPSRR	MD	MD.BTM	MD.TOP	MFO
	•			•				•

WALL REFRIGERATOR DOUBLE DOOR, 12" HIGH, 24" DEEP

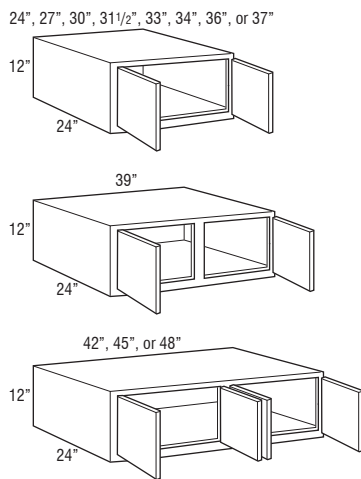

W241224	573	678	708	737	766	795	823	852	893	943	969	1048
W271224	591	696	726	755	784	813	864	894	924	967	992	1075
W301224	612	712	743	772	802	831	880	920	954	987	1017	1101
W31.51224	619	721	752	782	812	841	894	927	964	999	1027	1113
W331224	626	729	760	791	821	851	906	935	973	1011	1037	1124
W341224	635	737	767	797	828	858	913	945	982	1020	1047	1133
W361224	642	744	775	805	837	867	920	954	993	1027	1060	1145
W371224	655	754	785	816	848	879	933	971	1009	1044	1074	1164

W391224	666	764	795	827	858	889	945	983	1024	1062	1091	1182
----------------	-----	-----	-----	-----	-----	-----	-----	-----	------	------	------	------

W421224	704	805	839	872	906	939	999	1037	1080	1118	1147	1243
W451224	774	886	923	960	997	1034	1098	1141	1187	1230	1262	1368
W481224	851	973	1015	1056	1098	1138	1207	1256	1306	1353	1389	1503

- 24" deep cabinets must be fully supported by screws installed in a structural member in the ceiling or soffit, and into adjacent cabinets or tall panels.
- Load limit is 15 lbs. per square foot of load bearing surface.
- 42" or wider will feature four doors.

Custom Modifications

ADDTK	AUTH	CBO	CCO	CFNTO	CFRMO	CH	CND	CW	EXBK	EX	FB	FFD	FPEB	ID	INVFRM	MIP	P	PFINBTMB	RD	TD	TVR_V	
•	•		•	•				• ¹	•	•	•		•	•		•		•	•			

Construction Upgrades

APC	PE
•	•

Door Options

ALF	CG	CG.BTM	CG.TOP	DPSRR	MD	MD.BTM	MD.TOP	MFO
	•			•				•

¹ Not available on 42", 45", and 48" wide

WALL TOP HINGE REFRIGERATOR, 12" HIGH, 24" DEEP

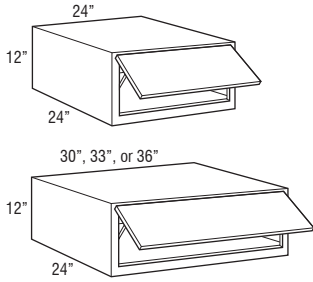

	Price Point	1	2	3	4	5	6	7	8	9	10	11	12
WTH241224		707	825	859	893	926	960	1017	1063	1104	1141	1177	1275
WTH301224		728	851	886	921	955	990	1048	1095	1139	1177	1214	1314
WTH331224		747	869	905	941	977	1011	1073	1118	1163	1202	1238	1342
WTH361224		766	886	923	960	997	1034	1096	1139	1185	1225	1262	1368

- 24" Wide (WTH241224) uses standard configuration doors. See Door Style Specifications page in Door Style section for details on doors with grain pattern exceptions.
- 30"-36" Wide (WTH301224-WTH361224) use non-standard configuration doors. See Door Style Specifications page in Door Style section for details on doors with grain pattern exceptions.
- Not available on all door styles. See Door Style section for exceptions.
- 24" deep cabinets must be fully supported by screws installed in a structural member in the ceiling or soffit, and into adjacent cabinets or tall panels.
- Load limit is 15 lbs. per square foot of load bearing surface.
- Art Glass not available.
- Cabinet may utilize one or two lift mechanisms depending on door size and weight. Door lift mechanism tension can be field adjusted.
- Depth can be reduced to a minimum of 9".
- Door will open a maximum of 107° due to hinges. For applications close to a ceiling, door angle can be restricted to 86° with a Hinge Angle Restriction Clip (HINGERESCLIP, see page 320).
- Lift mechanisms and mounting brackets will be visible if used with transparent textured glass.
- Lift mechanism not available for order for field installation, only available factory installed.

Custom Modifications

ADDTK	AUTH	CBO	CCO	CFNTO	CFRMO	CH	CND	CW	EXBK	EX	FB	FFD	FPEB	ID	INVERM	MIP	P	PFINBTMB	RD	TD	TVR_V	
	•		•			•	•		•	•	•		•	•		•		•	•			

Construction Upgrades

APC	PE
•	•

Door Options

ALF	CG	CG.BTM	CG.TOP	DPSRR	MD	MD.BTM	MD.TOP	MFO
• ¹	•			•				•

¹ Available only on 30" and 36" wide

WALL SINGLE DOOR, 15" HIGH

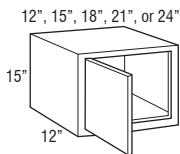

W1215 L or R	412	476	495	513	532	550	585	606	632	652	671	728
W1515 L or R	436	505	525	545	566	585	619	643	669	693	713	773
W1815 L or R	464	535	557	578	599	619	654	682	709	736	756	820
W2115 L or R	483	558	581	605	628	651	691	716	746	774	794	858
W2415 L or R	493	569	592	616	640	663	706	730	763	788	811	877

Custom Modifications

ADDTK	AUTH	CBO	CCO	CFNTO	CFRMO	CH	CND	CW	EXBK	EX	FB	FFD	FPEB	ID	INVERM	MIP	P	PFINBTMB	RD	TD	TVR_V
• ¹	•		•	•	•	•		• ²	•	•	•		•	•		•	•	•	•		

Construction Upgrades

APC	PE
•	•

Door Options

ALF	CG	CG.BTM	CG.TOP	DPSRR	MD	MD.BTM	MD.TOP	MFO
• ³	•			•	• ²			•

¹ Not available on 21" and 24" wide

² Not available on 12" wide

³ Not available on 12", 21", and 24" wide

WALL DOUBLE DOOR, 15" HIGH

21", 24", 27", 30", 31 1/2", 33", 34", 36", or 37"

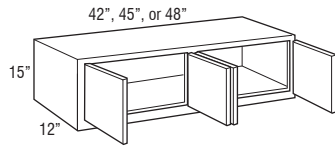
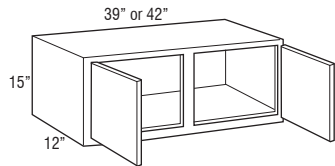
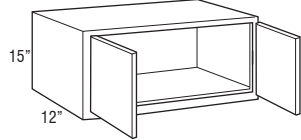

Price Point

	1	2	3	4	5	6	7	8	9	10	11	12
W2115	488	563	587	610	634	657	698	724	754	781	802	867
W2415	497	575	599	623	646	670	712	738	769	797	819	886
W2715	507	587	612	635	660	683	728	753	785	812	834	905
W3015	517	599	624	648	673	697	741	767	801	830	852	922
W31.515	530	615	641	665	690	715	758	787	820	849	872	945
W3315	541	631	656	681	707	731	775	806	838	868	892	968
W3415	550	641	666	692	718	744	785	818	851	880	907	981
W3615	558	651	676	701	727	752	799	831	862	892	920	993
W3715	570	663	689	713	738	763	809	841	874	906	932	1009
W3915	582	674	699	724	748	773	820	851	885	917	943	1021
W4215CS	596	689	715	740	766	791	838	870	905	939	967	1045
W4215	641	741	769	796	823	850	902	935	973	1009	1039	1124
W4515	687	797	827	856	885	914	970	1007	1047	1084	1118	1207
W4815	737	853	885	915	946	977	1037	1077	1119	1159	1195	1290

• W4215CS has two doors. W4215 has four doors.

Custom Modifications

ADDTK	AUTH	CBO	CCO	CFNTO	CFRMO	CH	CND	CW	EXBK	EX	FB	FFD	FPEB	ID	INVERM	MIP	P	PFINBTMB	RD	TD	TVR_V	
• ¹	•		•	•	•	• ¹		• ²	•	•	•		•	•		•	•	•	•			

Construction Upgrades

APC	PE
•	•

Door Options

ALF	CG	CG.BTM	CG.TOP	DPSRR	MD	MD.BTM	MD.TOP	MFO
	•			•	• ³			•

¹ Not available on 42" (2 doors) wide

² Not available on 21", 42" (4 doors), 45", and 48" wide

³ Available only on 24", 27", 30", 33", 36", 42" (2 doors), and 48" wide

WALL TOP HINGE, 15" HIGH

18", 21", or 24"

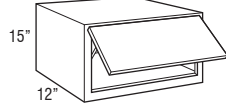

30", 33", or 36"

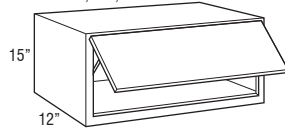

WTH1815	588	679	707	735	763	791	841	890	906	939	965	1046
WTH2115	595	684	713	741	771	799	850	898	915	949	974	1057
WTH2415	607	700	730	758	787	815	868	917	935	969	996	1079
WTH3015	619	715	745	774	803	832	886	936	954	989	1016	1101
WTH3315	644	745	776	805	836	865	921	976	992	1028	1055	1144
WTH3615	668	775	806	837	867	897	954	1015	1029	1066	1094	1185

• 18"-24" Wide (WTH1815-WTH2415) use standard configuration doors. See Door Style Specifications page in Door Style section for details on doors with grain pattern exceptions.

• 30"-36" Wide (WTH3015-WTH3615) use non-standard configuration doors. See Door Style Specifications page in Door Style section for details on doors with grain pattern exceptions.

• Not available on all door styles. See Door Style section for exceptions.

• Art Glass not available.

• Cabinet may utilize one or two lift mechanisms depending on door size and weight. Door lift mechanism tension can be field adjusted.

• Depth can be reduced to a minimum of 9".

• Door will open a maximum of 107° due to hinges. For applications close to a ceiling, door angle can be restricted to 86° with a Hinge Angle Restriction Clip (HINGERESCLIP, see page 320).

• Lift mechanisms and mounting brackets will be visible if used with transparent textured glass.

• Lift mechanism not available for order for field installation, only available factory installed.

Custom Modifications

ADDTK	AUTH	CBO	CCO	CFNTO	CFRMO	CH	CND	CW	EXBK	EX	FB	FFD	FPEB	ID	INVERM	MIP	P	PFINBTMB	RD	TD	TVR_V	
	•		•		•	•		• ¹	•	•	•		•	•		•		•	•			

Construction Upgrades

APC	PE
•	•

Door Options

ALF	CG	CG.BTM	CG.TOP	DPSRR	MD	MD.BTM	MD.TOP	MFO
• ²	•			•				•

¹ Not available on 18" wide

² Available only on 30" and 36" wide

WALL REFRIGERATOR SINGLE DOOR, 15" HIGH, 24" DEEP

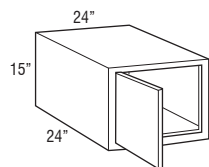

W241524 L or R	607	699	729	758	787	816	869	898	935	970	998	1080
----------------	-----	-----	-----	-----	-----	-----	-----	-----	-----	-----	-----	------

- 24" deep cabinets must be fully supported by screws installed in a structural member in the ceiling or soffit, and into adjacent cabinets or tall panels.
- Load limit is 15 lbs. per square foot of load bearing surface.

Custom Modifications

ADDTK	AUTH	CBO	CCO	CFNTO	CFRMO	CH	CND	CW	EXBK	EX	FB	FFD	FPEB	ID	INVFRM	MIP	P	PFINBTMB	RD	TD	TVR_V	
	•		•	•		•		•	•	•	•		•	•		•		•	•			

Construction Upgrades

APC	PE
•	•

Door Options

ALF	CG	CG.BTM	CG.TOP	DPSRR	MD	MD.BTM	MD.TOP	MFO
	•			•	•			•

WALL REFRIGERATOR DOUBLE DOOR, 15" HIGH, 24" DEEP

24", 27", 30", 31 1/2", 33", 34", 36", or 37"

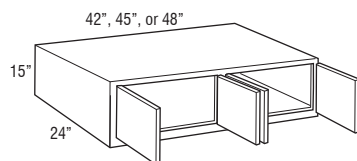
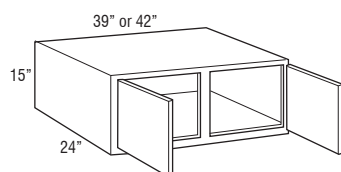
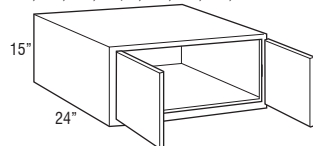

W241524	614	706	736	766	796	825	877	908	945	979	1009	1090
---------	-----	-----	-----	-----	-----	-----	-----	-----	-----	-----	------	------

W271524	615	706	737	768	800	831	880	915	953	984	1014	1096
---------	-----	-----	-----	-----	-----	-----	-----	-----	-----	-----	------	------

W301524	615	706	738	771	803	834	884	922	961	989	1019	1104
---------	-----	-----	-----	-----	-----	-----	-----	-----	-----	-----	------	------

W31.51524	628	722	755	786	819	850	900	937	977	1008	1037	1123
-----------	-----	-----	-----	-----	-----	-----	-----	-----	-----	------	------	------

W331524	642	739	771	802	833	865	917	953	991	1027	1054	1142
---------	-----	-----	-----	-----	-----	-----	-----	-----	-----	------	------	------

W341524	651	746	778	811	843	875	928	965	1004	1040	1067	1156
---------	-----	-----	-----	-----	-----	-----	-----	-----	------	------	------	------

W361524	657	753	786	819	851	884	939	976	1017	1052	1080	1169
---------	-----	-----	-----	-----	-----	-----	-----	-----	------	------	------	------

W371524	672	766	800	832	865	897	951	987	1027	1063	1093	1183
---------	-----	-----	-----	-----	-----	-----	-----	-----	------	------	------	------

W391524	684	780	812	844	877	908	960	997	1037	1073	1104	1196
---------	-----	-----	-----	-----	-----	-----	-----	-----	------	------	------	------

W421524CS	718	832	862	892	921	950	1008	1048	1089	1127	1164	1258
-----------	-----	-----	-----	-----	-----	-----	------	------	------	------	------	------

W421524	788	914	946	979	1011	1044	1108	1151	1196	1238	1278	1382
---------	-----	-----	-----	-----	------	------	------	------	------	------	------	------

W451524	847	980	1016	1052	1088	1122	1192	1239	1288	1333	1374	1487
---------	-----	-----	------	------	------	------	------	------	------	------	------	------

W481524	907	1048	1086	1124	1163	1201	1276	1325	1376	1426	1469	1588
---------	-----	------	------	------	------	------	------	------	------	------	------	------

- 24" deep cabinets must be fully supported by screws installed in a structural member in the ceiling or soffit, and into adjacent cabinets or tall panels.
- Load limit is 15 lbs. per square foot of load bearing surface.
- W421524CS has two doors. W421524 has four doors.

Custom Modifications

ADDTK	AUTH	CBO	CCO	CFNTO	CFRMO	CH	CND	CW	EXBK	EX	FB	FFD	FPEB	ID	INVFRM	MIP	P	PFINBTMB	RD	TD	TVR_V	
• ¹	•		•	•	•	• ¹		• ²	•	•	•		•	•		•		•	•			

Construction Upgrades

APC	PE
•	•

Door Options

ALF	CG	CG.BTM	CG.TOP	DPSRR	MD	MD.BTM	MD.TOP	MFO
	•			•	• ³			•

¹ Not available on 42" (2 doors) wide

² Not available on 42" (4 doors), 45", and 48" wide

³ Available only on 24", 27", 30", 33", 36", 42" (2 doors), and 48" wide

**WALL TOP HINGE REFRIGERATOR,
15" HIGH, 24" DEEP**

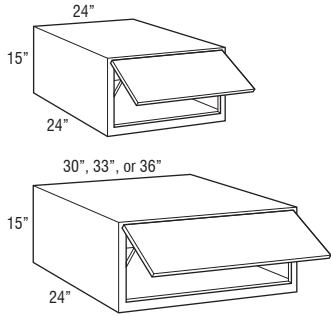

Price Point

	1	2	3	4	5	6	7	8	9	10	11	12
WTH241524	710	816	855	892	928	965	1023	1091	1107	1145	1182	1281
WTH301524	732	842	881	920	958	996	1054	1124	1141	1180	1219	1320
WTH331524	758	870	909	949	988	1026	1088	1156	1175	1219	1252	1357
WTH361524	784	897	936	976	1015	1054	1120	1187	1208	1254	1286	1394

- 24" Wide (WTH241524) uses standard configuration doors. See Door Style Specifications page in Door Style section for details on doors with grain pattern exceptions.
- 30"-36" Wide (WTH301524-WTH361524) use non-standard configuration doors. See Door Style Specifications page in Door Style section for details on doors with grain pattern exceptions.
- Not available on all door styles. See Door Style section for exceptions.
- 24" deep cabinets must be fully supported by screws installed in a structural member in the ceiling or soffit, and into adjacent cabinets or tall panels.
- Load limit is 15 lbs. per square foot of load bearing surface.
- Art Glass not available.
- Cabinet may utilize one or two lift mechanisms depending on door size and weight. Door lift mechanism tension can be field adjusted.
- Depth can be reduced to a minimum of 9".
- Door will open a maximum of 107° due to hinges. For applications close to a ceiling, door angle can be restricted to 86° with a Hinge Angle Restriction Clip (HINGERESCLIP, see page 320).
- Lift mechanisms and mounting brackets will be visible if used with transparent textured glass.
- Lift mechanism not available for order for field installation, only available factory installed.

Custom Modifications

ADDTK	AUTH	CBO	CCO	CFNTO	CFRMO	CH	CND	CW	EXBK	EX	FB	FFD	FPEB	ID	INVERM	MIP	P	PFINBTMB	RD	TD	TVR_V	
	•		•			•	•		•	•	•	•		•	•			•				

Construction Upgrades

APC	PE
•	•

Door Options

ALF	CG	CG.BTM	CG.TOP	DPSRR	MD	MD.BTM	MD.TOP	MFO
• ¹	•			•				•

¹ Available only on 30" and 36" wide

WALL SINGLE DOOR, 18" HIGH

12", 15", 18", 21", or 24"

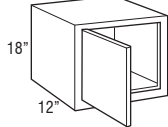

W1218 L or R	447	515	535	554	575	594	632	655	682	706	725	784
W1518 L or R	473	547	568	589	610	631	668	693	722	747	767	831
W1818 L or R	501	578	600	623	645	668	711	737	765	795	816	884
W2118 L or R	516	605	631	655	680	704	746	777	806	834	860	928
W2418 L or R	521	610	636	661	687	711	752	784	812	843	866	936

Custom Modifications

ADDTK	AUTH	CBO	CCO	CFNTO	CFRMO	CH	CND	CW	EXBK	EX	FB	FFD	FPEB	ID	INVERM	MIP	P	PFINBTMB	RD	TD	TVR_V
•	•		•	•		•	•	• ¹	•	•	•	•	•	•		•	•	•	•	•	•

Construction Upgrades

APC	PE
•	•

Door Options

ALF	CG	CG.BTM	CG.TOP	DPSRR	MD	MD.BTM	MD.TOP	MFO
	•			•	• ¹			•

¹ Not available on 12" wide

WALL DOUBLE DOOR, 18" HIGH

24", 27", 30", 31 1/2", 33", 34", 36", or 37"

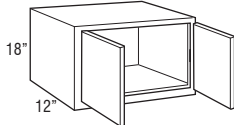

39", 42", 45", or 48"

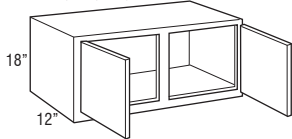

48"

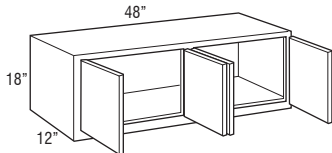

Price Point

	1	2	3	4	5	6	7	8	9	10	11	12
W2418	525	614	640	664	690	715	757	788	816	851	871	943
W2718	539	626	651	675	700	724	768	800	832	861	885	960
W3018	558	647	672	697	721	746	793	825	858	886	913	988
W31.518	572	665	691	717	743	768	815	849	884	913	940	1016
W3318	587	683	710	737	764	791	837	872	908	939	965	1044
W3418	597	692	720	747	774	801	851	884	920	953	977	1060
W3618	605	700	728	755	783	810	862	893	931	963	988	1072
W3718	619	715	744	773	802	830	881	914	950	986	1010	1094

W3918	631	729	759	790	820	849	900	933	970	1009	1032	1116
W4218	655	757	787	818	848	878	930	970	1009	1044	1073	1161
W4518	706	814	847	879	912	943	1001	1042	1083	1122	1154	1249
W4818CS	755	872	907	942	977	1011	1071	1114	1158	1201	1233	1336

W4818	857	989	1028	1066	1104	1142	1211	1258	1306	1357	1394	1508
--------------	-----	-----	------	------	------	------	------	------	------	------	------	------

Custom Modifications

ADDTK	AUTH	CBO	CCO	CFNTD	CFRMO	CH	CND	CW	EXBK	EX	FB	FFD	FPEB	ID	INVFRM	MIP	P	PFINBTMB	RD	TD	TVR_V
•	•		•	•	•	• ¹		• ²	•	•	•	•	•	•		•	•	•	•	•	• ³

Construction Upgrades

APC	PE
•	•

Door Options

ALF	CG	CG.BTM	CG.TOP	DPSRR	MD	MD.BTM	MD.TOP	MFO
	•			•	• ⁴			•

¹ Not available on 45" and 48" (2 doors) wide

² Not available on 24" and 48" (4 doors) wide

³ Not available on 39", 42", 45", and 48" wide

⁴ Not available on 31 1/2", 34", 37", and 39" wide

WALL TOP HINGE, 18" HIGH

18", 21", or 24"

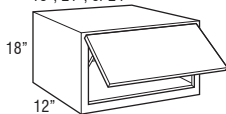

30", 33", or 36"



WTH1818	635	731	760	790	819	847	897	953	972	1007	1034	1118
WTH2118	641	739	768	797	827	855	906	962	981	1017	1044	1130
WTH2418	654	754	784	813	843	872	925	982	1002	1038	1067	1154

WTH3018	668	769	800	830	860	890	944	1002	1023	1060	1089	1177
WTH3318	696	802	833	866	897	930	987	1047	1066	1104	1135	1229
WTH3618	722	833	867	900	934	968	1029	1092	1109	1149	1180	1279

- 18"-24" Wide (WTH1818-WTH2418) use standard configuration doors. See Door Style Specifications page in Door Style section for details on doors with grain pattern exceptions.
- 30"-36" Wide (WTH3018-WTH3618) use non-standard configuration doors. See Door Style Specifications page in Door Style section for details on doors with grain pattern exceptions.
- Not available on all door styles. See Door Style section for exceptions.
- Art Glass not available.
- Cabinet may utilize one or two lift mechanisms depending on door size and weight. Door lift mechanism tension can be field adjusted.
- Depth can be reduced to a minimum of 9".
- Door will open a maximum of 107° due to hinges. For applications close to a ceiling, door angle can be restricted to 86° with a Hinge Angle Restriction Clip (HINGERESCLIP, see page 320).
- Lift mechanisms and mounting brackets will be visible if used with transparent textured glass.
- Lift mechanism not available for order for field installation, only available factory installed.

Custom Modifications

ADDTK	AUTH	CBO	CCO	CFNTD	CFRMO	CH	CND	CW	EXBK	EX	FB	FFD	FPEB	ID	INVFRM	MIP	P	PFINBTMB	RD	TD	TVR_V
	•		•		•	•		• ¹	•	•	•	•	•	•		•		•	•	•	

Construction Upgrades

APC	PE
•	•

Door Options

ALF	CG	CG.BTM	CG.TOP	DPSRR	MD	MD.BTM	MD.TOP	MFO
• ²	•			•				•

¹ Not available on 18" wide

² Available only on 30" and 36" wide

WALL VERTICAL-LIFT, 18" HIGH, 12" DEEP

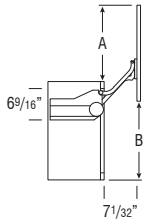
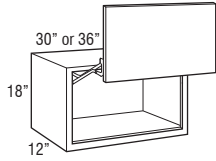

	Full Overlay	Modified Full Overlay	Partial Overlay
A	16 13/16"	16 1/16"	16 1/16"
B	17 5/16"	17 5/16"	18 1/16"

WVL3018	1906	1995	2020	2045	2069	2094	2141	2173	2206	2234	2261	2336
WVL3618	1953	2048	2076	2103	2131	2158	2210	2241	2279	2311	2336	2420

- Uses non-standard configuration doors. See Door Style Specifications page in Door Style section for details on doors with grain pattern exceptions.
- Decorative hardware required.
- See side view drawing for required clearances.
- Lift mechanism features a single motion for up and out movement with soft-close, tension can be field adjusted.
- Lift mechanisms and mounting brackets will be visible if used with transparent textured glass.
- Lift mechanism not available for order for field installation, only available factory installed.
- Hardware extends 1" into opening on each side.
- Art Glass not available.
- Not available on all door styles. See Door Style section for exceptions.
- When textured glass is ordered for use in wall vertical-lift cabinets, glass design will be turned horizontally and may not match desired pattern.

Custom Modifications

ADDTK	AUTH	CBO	CCO	CFNTO	CFRMO	CH	CND	CW	EXBK	EX	FB	FFD	FPEB	ID	INVERM	MIP	P	PFINBTMB	RD	TD	TVR_V	
	•		•		•			• ¹	•	•	•		•	•		•		•				

Construction Upgrades

APC	PE
•	•

Door Options

ALF	CG	CG.BTM	CG.TOP	DPSRR	MD	MD.BTM	MD.TOP	MFO
•	•			•				•

¹ Not available on 30" wide

WALL REFRIGERATOR SINGLE or DOUBLE DOOR, 18" HIGH, 24" DEEP

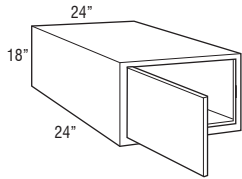

24", 27", 30", 31 1/2", 33", 34", 36", or 37"

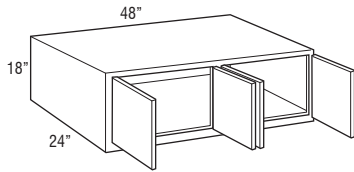
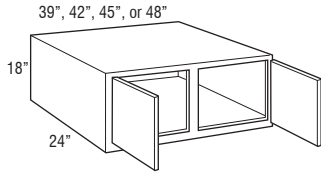
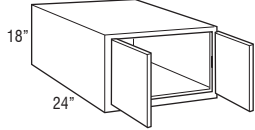

W241824 L or R	641	748	780	811	842	874	924	965	998	1037	1066	1152
-----------------------	-----	-----	-----	-----	-----	-----	-----	-----	-----	------	------	------

W241824	647	754	785	816	848	879	931	970	1006	1045	1073	1160
W271824	652	753	788	823	859	894	945	983	1023	1062	1090	1179
W301824	655	750	791	830	870	909	961	998	1038	1077	1105	1197
W31.51824	669	771	811	851	892	932	986	1023	1063	1103	1131	1225
W331824	682	790	831	871	913	953	1009	1047	1088	1128	1157	1253
W341824	692	804	846	886	926	967	1025	1064	1107	1146	1178	1276
W361824	702	814	857	898	940	981	1042	1082	1124	1164	1197	1296
W371824	722	840	885	928	973	1017	1077	1120	1166	1206	1240	1343

W391824	741	865	912	959	1006	1052	1114	1158	1206	1249	1284	1391
W421824	781	912	964	1017	1070	1121	1191	1235	1286	1331	1366	1478
W451824	831	970	1025	1079	1133	1187	1260	1307	1360	1411	1447	1568
W481824CS	880	1027	1084	1140	1197	1253	1328	1381	1435	1488	1528	1654

W481824	981	1142	1203	1263	1324	1384	1467	1527	1587	1644	1687	1828
----------------	-----	------	------	------	------	------	------	------	------	------	------	------

- 24" deep cabinets must be fully supported by screws installed in a structural member in the ceiling or soffit, and into adjacent cabinets or tall panels.
- Load limit is 15 lbs. per square foot of load bearing surface.

Custom Modifications

ADDTK	AUTH	CBO	CCO	CFNTO	CFRMO	CH	CND	CW	EXBK	EX	FB	FFD	FPEB	ID	INVERM	MIP	P	PFINBTMB	RD	TD	TVR_V
•	•		•	•	•	• ¹		• ²	•	•	•	•	•	•		•		•	•	• ³	

Construction Upgrades

APC	PE
•	•

Door Options

ALF	CG	CG.BTM	CG.TOP	DPSRR	MD	MD.BTM	MD.TOP	MFO
•	•			•	• ⁴			•

¹ Not available on 45" and 48" (2 doors) wide

² Not available on 24" (2 doors) and 48" (4 doors) wide

³ Not available on 39", 42", 45", and 48" wide

⁴ Available only on 24", 27", 30", 33", 36", 42", 45", and 48" wide

WALL TOP HINGE REFRIGERATOR, 18" HIGH, 24" DEEP

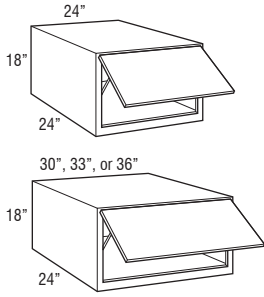

	Price Point	1	2	3	4	5	6	7	8	9	10	11	12
WTH241824		758	868	914	960	1005	1051	1110	1180	1201	1245	1279	1385
WTH301824		782	895	942	989	1036	1083	1145	1217	1238	1284	1318	1428
WTH331824		809	935	983	1032	1080	1128	1193	1270	1290	1336	1373	1487
WTH361824		837	973	1024	1073	1122	1172	1240	1320	1342	1389	1428	1548

- 24" Wide (WTH241824) uses standard configuration doors. See Door Style Specifications page in Door Style section for details on doors with grain pattern exceptions.
- 30"-36" Wide (WTH301824-WTH361824) use non-standard configuration doors. See Door Style Specifications page in Door Style section for details on doors with grain pattern exceptions.
- Not available on all door styles. See Door Style section for exceptions.
- 24" deep cabinets must be fully supported by screws installed in a structural member in the ceiling or soffit, and into adjacent cabinets or tall panels.
- Load limit is 15 lbs. per square foot of load bearing surface.
- Art Glass not available.
- Cabinet may utilize one or two lift mechanisms depending on door size and weight. Door lift mechanism tension can be field adjusted.
- Depth can be reduced to a minimum of 9".
- Door will open a maximum of 107° due to hinges. For applications close to a ceiling, door angle can be restricted to 86° with a Hinge Angle Restriction Clip (HINGERESCLIP, see page 320).
- Lift mechanisms and mounting brackets will be visible if used with transparent textured glass.
- Lift mechanism not available for order for field installation, only available factory installed.

Custom Modifications

ADDTK	AUTH	CBO	CCO	CFNTO	CFRMO	CH	CND	CW	EXBK	EX	FB	FFD	FPEB	ID	INVERM	MIP	P	PFINBTMB	RD	TD	TVR_V	
	•		•		•	•		•	•	•	•		•	•		•		•	•	•		

Construction Upgrades

APC	PE
•	•

Door Options

ALF	CG	CG.BTM	CG.TOP	DPSRR	MD	MD.BTM	MD.TOP	MFO
• ¹	•			•				•

¹ Available only on 30" and 36" wide

WALL REFRIGERATOR VERTICAL-LIFT, 18" HIGH, 24" DEEP

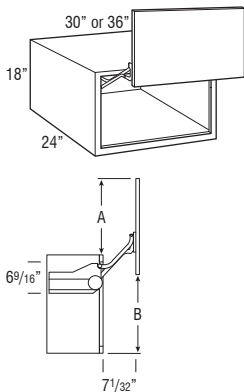

	Full Overlay	Modified Full Overlay	Partial Overlay
A	16 13/16"	16 1/16"	16 1/16"
B	17 5/16"	17 5/16"	18 1/16"

WVL301824	2003	2098	2139	2178	2218	2257	2309	2346	2386	2425	2453	2545
WVL361824	2050	2162	2205	2246	2288	2329	2390	2430	2472	2512	2545	2644

- Uses non-standard configuration doors. See Door Style Specifications page in Door Style section for details on doors with grain pattern exceptions.
- 24" deep cabinets must be fully supported by screws installed in a structural member in the ceiling or soffit, and into adjacent cabinets or tall panels.
- Decorative hardware required.
- See side view drawing for required clearances.
- Lift mechanism features a single motion for up and out movement with soft-close, tension can be field adjusted.
- Lift mechanisms and mounting brackets will be visible if used with transparent textured glass.
- Lift mechanism not available for order for field installation, only available factory installed.
- Hardware extends 1" into opening on each side.
- Art Glass not available.
- Not available on all door styles. See Door Style section for exceptions.
- Depth can be reduced to a minimum of 12".
- When textured glass is ordered for use in wall vertical-lift cabinets, glass design will be turned horizontally and may not match desired pattern.

Custom Modifications

ADDTK	AUTH	CBO	CCO	CFNTO	CFRMO	CH	CND	CW	EXBK	EX	FB	FFD	FPEB	ID	INVERM	MIP	P	PFINBTMB	RD	TD	TVR_V	
	•		•		•			• ¹	•	•	•		•	•		•		•	•	•		

Construction Upgrades

APC	PE
•	•

Door Options

ALF	CG	CG.BTM	CG.TOP	DPSRR	MD	MD.BTM	MD.TOP	MFO
•	•			•				•

¹ Not available on 30" wide

WALL REFRIGERATOR PULL-OUT, 18" HIGH, 24" DEEP

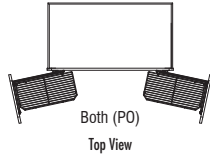
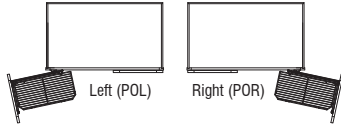
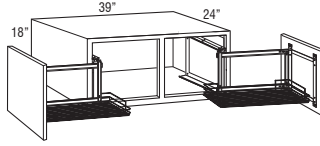
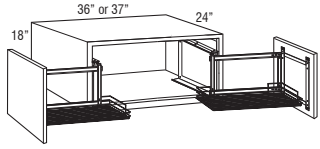

Price Point

	1	2	3	4	5	6	7	8	9	10	11	12
W361824PO L or R	2337	2449	2492	2533	2575	2616	2677	2717	2759	2799	2832	2931
W371824PO L or R	2357	2475	2520	2563	2608	2652	2712	2755	2801	2841	2875	2978
W361824PO	3972	4084	4127	4168	4210	4251	4312	4352	4394	4434	4467	4566
W371824PO	3992	4110	4155	4198	4243	4287	4347	4390	4436	4476	4510	4613

W391824PO L or R	2376	2500	2547	2594	2641	2687	2749	2793	2841	2884	2919	3026
W391824PO	4011	4135	4182	4229	4276	4322	4384	4428	4476	4519	4554	4661

- Door-mounted pull-out with a chrome wire rack that extends fully to the front of the cabinet then opens to the side for easy accessibility to contents. Designed for use above refrigerators or other high applications. Soft-close not included.
- Available installed in either the left side, right side, or both sides.
- For sufficient pull-out clearance, 13 1/8" of adjacent space is required for door to open fully when installed near a wall or corner.
- Chrome rack is 10" wide and 20 13/16" deep.
- 24" deep cabinets must be fully supported by screws installed in a structural member in the ceiling or soffit, and into adjacent cabinets or tall panels.
- Load limit is 20 lbs. per pull-out.

Custom Modifications

ADDTK	AUTH	CBO	CCO	CFNTO	CFRMO	CH	CND	CW	EXBK	EX	FB	FFD	FPEB	ID	INVFRM	MIP	P	PFINBTMB	RD	TD	TVR_V	
•	•	•				•			•	•	•		•			•		•				

Construction Upgrades

APC	PE
•	•

Door Options

ALF	CG	CG.BTM	CG.TOP	DPSRR	MD	MD.BTM	MD.TOP	MFO
				•				•

WALL SINGLE DOOR, 21" HIGH

9", 12", 15", 18", 21", or 24"

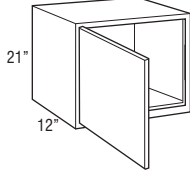

W921 L or R	450	505	528	551	574	597	635	658	686	710	731	790
W1221 L or R	459	515	539	562	586	609	648	671	700	724	746	806
W1521 L or R	485	544	569	594	618	643	680	706	735	764	783	851
W1821 L or R	508	571	597	623	648	674	717	745	774	802	825	894
W2121 L or R	535	604	631	657	684	711	755	783	813	847	868	940
W2421 L or R	552	620	650	678	706	734	778	808	839	870	897	971

Custom Modifications

ADDTK	AUTH	CBO	CCO	CFNTO	CFRMO	CH	CND	CW	EXBK	EX	FB	FFD	FPEB	ID	INVFRM	MIP	P	PFINBTMB	RD	TD	TVR_V	
•	•		•	•			• ¹		• ¹	•	•	•	•	•		•	•	•	•	•		

Construction Upgrades

APC	PE
•	•

Door Options

ALF	CG	CG.BTM	CG.TOP	DPSRR	MD	MD.BTM	MD.TOP	MFO
	•			•				•

¹ Not available on 9" wide

WALL DOUBLE DOOR, 21" HIGH

24", 27", 30", 31 1/2", 33", 34", 36", or 37"

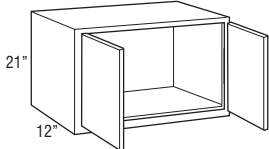

39", 42", 45", or 48"

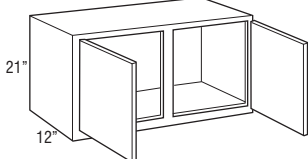

48"

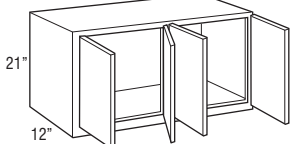

Price Point

	1	2	3	4	5	6	7	8	9	10	11	12
W2421	576	650	679	708	737	765	810	840	874	908	932	1011
W2721	592	669	699	729	759	790	834	867	899	935	962	1042
W3021	618	697	728	759	791	821	870	903	937	974	1001	1085
W31.521	634	718	748	778	808	837	889	921	958	995	1020	1107
W3321	648	739	768	796	824	852	908	937	977	1014	1039	1128
W3421	661	759	787	814	842	869	924	955	996	1033	1061	1148
W3621	673	777	804	831	858	884	939	976	1017	1052	1080	1169
W3721	685	791	820	848	876	904	960	996	1035	1073	1102	1193

W3921	702	806	836	865	894	922	979	1018	1055	1095	1122	1219
W4221	728	838	869	899	930	960	1018	1055	1100	1139	1168	1266
W4521	774	892	924	956	989	1020	1081	1122	1167	1211	1241	1344
W4821CS	820	942	977	1011	1046	1080	1145	1187	1236	1281	1315	1422

W4821	912	1048	1086	1124	1163	1200	1272	1320	1373	1422	1460	1583
--------------	-----	------	------	------	------	------	------	------	------	------	------	------

Custom Modifications

ADDTK	AUTH	CBO	CCO	CFNTO	CFRMO	CH	CND	CW	EXBK	EX	FB	FFD	FPEB	ID	INFRM	MIP	P	PFINBTMB	RD	TD	TVR_V	
•	•	•	•	•	•	•	•	• ¹	•	•	•	•	•	•	•	•	•	•	•	•	• ²	•

Construction Upgrades

APC	PE
•	•

Door Options

ALF	CG	CG.BTM	CG.TOP	DPSRR	MD	MD.BTM	MD.TOP	MFO
•	•	•	•	•	•	•	•	•

¹ Not available on 24" and 48" (4 doors) wide

² Not available on 39", 42", 45", and 48" wide

WALL TOP HINGE, 21" HIGH

18", 21", or 24"

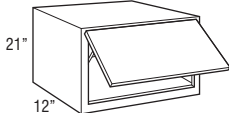

30", 33", or 36"

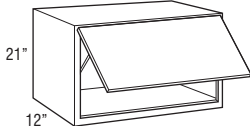

WTH1821	934	1020	1056	1092	1128	1163	1217	1259	1299	1336	1366	1459
WTH2121	943	1032	1067	1103	1139	1174	1230	1271	1313	1350	1380	1474
WTH2421	962	1054	1090	1126	1163	1198	1256	1298	1341	1379	1409	1505
WTH3021	982	1075	1112	1149	1186	1223	1281	1325	1368	1407	1438	1536
WTH3321	1017	1123	1158	1192	1226	1260	1323	1366	1411	1453	1484	1586
WTH3621	1051	1170	1203	1234	1266	1297	1364	1408	1455	1499	1530	1636

- 18"-24" Wide (WTH1821-WTH2421) use standard configuration doors. See Door Style Specifications page in Door Style section for details on doors with grain pattern exceptions.
- 30"-36" Wide (WTH3021-WTH3621) use non-standard configuration doors. See Door Style Specifications page in Door Style section for details on doors with grain pattern exceptions.
- Not available on all door styles. See Door Style section for exceptions.
- Art Glass not available.
- Cabinet may utilize one or two lift mechanisms depending on door size and weight. Door lift mechanism tension can be field adjusted.
- Depth can be reduced to a minimum of 9".
- Door will open a maximum of 107° due to hinges. For applications close to a ceiling, door angle can be restricted to 86° with a Hinge Angle Restriction Clip (HINGERESCLIP, see page 320).
- Lift mechanisms and mounting brackets will be visible if used with transparent textured glass.
- Lift mechanism not available for order for field installation, only available factory installed.

Custom Modifications

ADDTK	AUTH	CBO	CCO	CFNTO	CFRMO	CH	CND	CW	EXBK	EX	FB	FFD	FPEB	ID	INFRM	MIP	P	PFINBTMB	RD	TD	TVR_V	
•	•	•	•	•	•	•	•	• ¹	•	•	•	•	•	•	•	•	•	•	•	•	•	•

Construction Upgrades

APC	PE
•	•

Door Options

ALF	CG	CG.BTM	CG.TOP	DPSRR	MD	MD.BTM	MD.TOP	MFO
• ²	•	•	•	•	•	•	•	•

¹ Not available on 18" wide

² Available only on 30" and 36" wide

WALL VERTICAL-LIFT, 21" HIGH, 12" DEEP

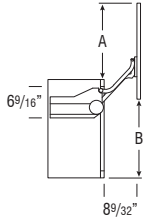
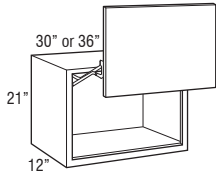

	Full Overlay	Modified Full Overlay	Partial Overlay
A	20"	19 1/4"	19 1/4"
B	20 1/2"	20 1/2"	21 1/4"

Price Point	1	2	3	4	5	6	7	8	9	10	11	12
WVL3021	1966	2045	2076	2107	2139	2169	2218	2251	2285	2322	2349	2433
WVL3621	2021	2125	2152	2179	2206	2232	2287	2324	2365	2400	2428	2517

- Uses non-standard configuration doors. See Door Style Specifications page in Door Style section for details on doors with grain pattern exceptions.
- Decorative hardware required.
- See side view drawing for required clearances.
- Lift mechanism features a single motion for up and out movement with soft-close, tension can be field adjusted.
- Lift mechanisms and mounting brackets will be visible if used with transparent textured glass.
- Lift mechanism not available for order for field installation, only available factory installed.
- Hardware extends 1" into opening on each side.
- Art Glass not available.
- Not available on all door styles. See Door Style section for exceptions.
- When textured glass is ordered for use in wall vertical-lift cabinets, glass design will be turned horizontally and may not match desired pattern.

Custom Modifications

ADDTK	AUTH	CBO	CCO	CFNTO	CFRMO	CH	CND	CW	EXBK	EX	FB	FFD	FPEB	ID	INVERM	MIP	P	PFINBTMB	RD	TD	TVR_V	
	•		•		•	•		• ¹	•	•	•		•	•		•		•				

Construction Upgrades

APC	PE
•	•

Door Options

ALF	CG	CG.BTM	CG.TOP	DPSRR	MD	MD.BTM	MD.TOP	MFO
•	•			•				•

¹ Not available on 30" wide

WALL REFRIGERATOR SINGLE or DOUBLE DOOR, 21" HIGH, 24" DEEP

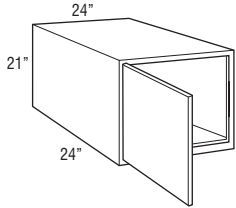

24", 27", 30", 31 1/2", 33", 34", 36", or 37"

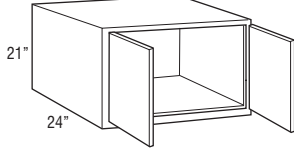

39", 42", 45", or 48"

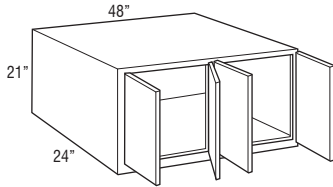
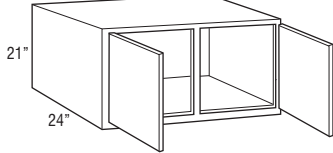

W242124 L or R	679	764	800	834	870	905	958	992	1032	1071	1102	1194
-----------------------	-----	-----	-----	-----	-----	-----	-----	-----	------	------	------	------

W242124	709	797	833	868	904	939	997	1033	1077	1114	1147	1243
W272124	715	810	849	887	926	964	1021	1062	1103	1144	1176	1275
W302124	720	822	864	905	946	987	1045	1088	1130	1173	1202	1305
W31.52124	732	838	879	920	961	1000	1060	1103	1146	1187	1220	1323
W332124	745	853	894	934	974	1014	1074	1118	1161	1202	1236	1340
W342124	759	874	914	954	995	1034	1096	1140	1186	1228	1262	1368
W362124	773	893	933	973	1014	1054	1118	1161	1208	1251	1287	1396
W372124	788	914	954	995	1035	1074	1139	1186	1233	1276	1313	1422

W392124	804	933	973	1014	1054	1094	1159	1207	1256	1298	1337	1449
W422124	895	1030	1068	1105	1144	1180	1252	1297	1351	1400	1438	1556
W452124	952	1096	1137	1176	1215	1254	1329	1380	1436	1490	1528	1655
W482124CS	1009	1160	1203	1244	1287	1328	1409	1460	1520	1576	1618	1752

W482124	1120	1290	1337	1383	1429	1475	1566	1622	1690	1752	1795	1947
----------------	------	------	------	------	------	------	------	------	------	------	------	------

- 24" deep cabinets must be fully supported by screws installed in a structural member in the ceiling or soffit, and into adjacent cabinets or tall panels.
- Load limit is 15 lbs. per square foot of load bearing surface.

Custom Modifications

ADDTK	AUTH	CBO	CCO	CFNTO	CFRMO	CH	CND	CW	EXBK	EX	FB	FFD	FPEB	ID	INVERM	MIP	P	PFINBTMB	RD	TD	TVR_V
•	•		•	•	•	•		• ¹	•	•	•	•	•	•		•		•	•	• ²	

Construction Upgrades

APC	PE
•	•

Door Options

ALF	CG	CG.BTM	CG.TOP	DPSRR	MD	MD.BTM	MD.TOP	MFO
•	•			•				•

¹ Not available on 24" (2 doors) and 48" (4 doors) wide

² Not available on 39", 42", 45", and 48" wide

WALL TOP HINGE REFRIGERATOR, 21" HIGH, 24" DEEP

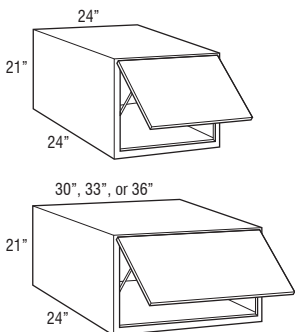

	Price Point	1	2	3	4	5	6	7	8	9	10	11	12
WTH242124		1061	1177	1224	1271	1317	1363	1434	1482	1532	1575	1613	1727
WTH302124		1104	1226	1276	1324	1372	1420	1493	1543	1596	1641	1680	1799
WTH332124		1136	1270	1318	1366	1415	1462	1536	1588	1643	1689	1728	1851
WTH362124		1166	1314	1361	1408	1455	1501	1579	1634	1689	1736	1776	1904

- 24" Wide (WTH242124) uses standard configuration doors. See Door Style Specifications page in Door Style section for details on doors with grain pattern exceptions.
- 30"-36" Wide (WTH302124-WTH362124) use non-standard configuration doors. See Door Style Specifications page in Door Style section for details on doors with grain pattern exceptions.
- Not available on all door styles. See Door Style section for exceptions.
- 24" deep cabinets must be fully supported by screws installed in a structural member in the ceiling or soffit, and into adjacent cabinets or tall panels.
- Load limit is 15 lbs. per square foot of load bearing surface.
- Art Glass not available.
- Cabinet may utilize one or two lift mechanisms depending on door size and weight. Door lift mechanism tension can be field adjusted.
- Depth can be reduced to a minimum of 9".
- Door will open a maximum of 107° due to hinges. For applications close to a ceiling, door angle can be restricted to 86° with a Hinge Angle Restriction Clip (HINGERESCLIP, see page 320).
- Lift mechanisms and mounting brackets will be visible if used with transparent textured glass.
- Lift mechanism not available for order for field installation, only available factory installed.

Custom Modifications

ADDTK	AUTH	CBO	CCO	CFNTO	CFRMO	CH	CND	CW	EXBK	EX	FB	FFD	FPEB	ID	INFRM	MIP	P	PFINBTMB	RD	TD	TVR_V	
	•		•		•	•		•	•	•	•		•	•		•		•	•	•		

Construction Upgrades

APC	PE
•	•

Door Options

ALF	CG	CG.BTM	CG.TOP	DPSRR	MD	MD.BTM	MD.TOP	MFO
• ¹	•			•				•

¹ Available only on 30" and 36" wide

WALL REFRIGERATOR VERTICAL-LIFT, 21" HIGH, 24" DEEP

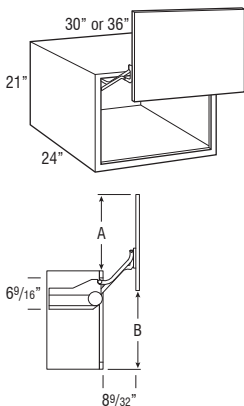

	Full Overlay	Modified Full Overlay	Partial Overlay
A	20"	19 1/4"	19 1/4"
B	20 1/2"	20 1/2"	21 1/4"

	2068	2170	2212	2253	2294	2335	2393	2436	2478	2521	2550	2653
WVL302124												
WVL362124		2121	2241	2281	2321	2362	2402	2466	2509	2556	2599	2744

- Uses non-standard configuration doors. See Door Style Specifications page in Door Style section for details on doors with grain pattern exceptions.
- 24" deep cabinets must be fully supported by screws installed in a structural member in the ceiling or soffit, and into adjacent cabinets or tall panels.
- Decorative hardware required.
- See side view drawing for required clearances.
- Lift mechanism features a single motion for up and out movement with soft-close, tension can be field adjusted.
- Lift mechanisms and mounting brackets will be visible if used with transparent textured glass.
- Lift mechanism not available for order for field installation, only available factory installed.
- Hardware extends 1" into opening on each side.
- Art Glass not available.
- Not available on all door styles. See Door Style section for exceptions.
- Depth can be reduced to a minimum of 12".
- When textured glass is ordered for use in wall vertical-lift cabinets, glass design will be turned horizontally and may not match desired pattern.

Custom Modifications

ADDTK	AUTH	CBO	CCO	CFNTO	CFRMO	CH	CND	CW	EXBK	EX	FB	FFD	FPEB	ID	INFRM	MIP	P	PFINBTMB	RD	TD	TVR_V	
	•		•		•	•		• ¹	•	•	•		•	•		•		•	•	•		

Construction Upgrades

APC	PE
•	•

Door Options

ALF	CG	CG.BTM	CG.TOP	DPSRR	MD	MD.BTM	MD.TOP	MFO
•	•			•				•

¹ Not available on 30" wide

**WALL REFRIGERATOR PULL-OUT,
21" HIGH, 24" DEEP**

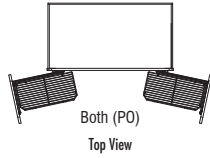
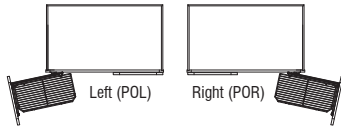
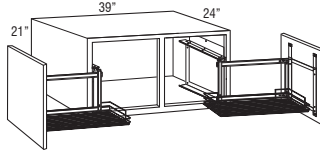
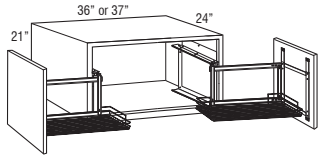

WALL SINGLE DOOR, 24" HIGH

9", 12", 15", 18", 21", or 24"

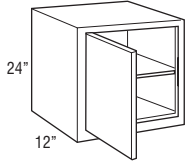

Price Point	1	2	3	4	5	6	7	8	9	10	11	12
W362124PO L or R	2408	2528	2568	2608	2649	2689	2753	2796	2843	2886	2922	3031
W372124PO L or R	2423	2549	2589	2630	2670	2709	2774	2821	2868	2911	2948	3057
W362124PO	4043	4163	4203	4243	4284	4324	4388	4431	4478	4521	4557	4666
W372124PO	4058	4184	4224	4265	4305	4344	4409	4456	4503	4546	4583	4692

W392124PO L or R	2439	2568	2608	2649	2689	2729	2794	2842	2891	2933	2972	3084
W392124PO	4074	4203	4243	4284	4324	4364	4429	4477	4526	4568	4607	4719

- Door-mounted pull-out with a chrome wire rack that extends fully to the front of the cabinet then opens to the side for easy accessibility to contents. Designed for use above refrigerators or other high applications. Soft-close not included.
- Available installed in either the left side, right side, or both sides.
- For sufficient pull-out clearance, 13 1/8" of adjacent space is required for door to open fully when installed near a wall or corner.
- Chrome rack is 10" wide and 20 13/16" deep.
- 24" deep cabinets must be fully supported by screws installed in a structural member in the ceiling or soffit, and into adjacent cabinets or tall panels.
- Load limit is 20 lbs. per pull-out.

Custom Modifications

ADDTK	AUTH	CBO	CCO	CFNTO	CFRMO	CH	CND	CW	EXBK	EX	FB	FFD	FPEB	ID	INVFRM	MIP	P	PFINBTMB	RD	TD	TVR_V	
•	•		•			•			•	•	•		•			•		•				

Construction Upgrades

APC	PE
•	•

Door Options

ALF	CG	CG.BTM	CG.TOP	DPSRR	MD	MD.BTM	MD.TOP	MFO
				•				•

W924 L or R	406	448	464	477	493	507	536	558	579	603	619	670
W1224 L or R	414	457	473	487	503	517	547	569	591	615	632	684
W1524 L or R	426	468	484	498	513	528	558	581	605	628	645	698
W1824 L or R	450	494	510	524	540	554	589	612	636	660	675	731
W2124 L or R	494	543	560	577	594	609	648	672	699	728	745	805
W2424 L or R	488	547	564	582	600	618	657	680	706	737	753	814

Custom Modifications

•	•	•	•	•	•	•	•	• ¹	•	•	•	•	•	•	•	•	•	•	•	•	•	•
---	---	---	---	---	---	---	---	----------------	---	---	---	---	---	---	---	---	---	---	---	---	---	---

Construction Upgrades

APC	PE
•	•

Door Options

ALF	CG	CG.BTM	CG.TOP	DPSRR	MD	MD.BTM	MD.TOP	MFO
	•			•	• ²			•

¹ Not available on 9" wide
² Not available on 9" and 12" wide

WALL DOUBLE DOOR, 24" HIGH

24", 27", 30", 31 1/2", 33", 34", 36", or 37"

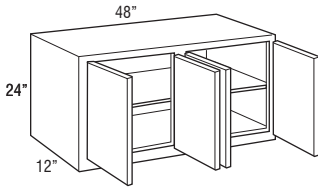
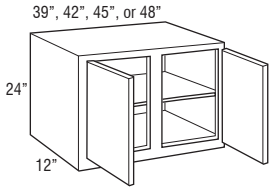
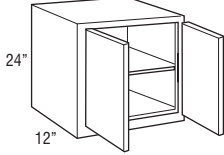

Price Point

	1	2	3	4	5	6	7	8	9	10	11	12
W2424	558	631	665	699	732	766	810	844	879	911	933	1014
W2724	578	653	691	729	767	805	856	889	926	959	984	1068
W3024	653	738	766	793	820	847	899	931	969	1008	1030	1114
W31.524	671	758	790	821	851	883	937	971	1010	1051	1073	1163
W3324	688	777	813	848	883	917	974	1011	1052	1092	1116	1210
W3424	697	787	825	862	899	936	993	1033	1074	1114	1141	1236
W3624	706	797	838	877	917	956	1014	1054	1095	1137	1166	1263
W3724	731	827	866	904	943	981	1040	1081	1124	1166	1196	1296

W3924	758	857	895	932	970	1007	1066	1105	1152	1194	1226	1328
W4224	769	869	915	960	1006	1051	1114	1157	1205	1247	1280	1387
W4524	824	932	979	1026	1073	1119	1186	1250	1324	1351	1413	1532
W4824CS	881	996	1044	1091	1138	1185	1259	1343	1439	1452	1547	1676

W4824	992	1121	1172	1222	1272	1322	1401	1529	1674	1704	1812	1961
--------------	-----	------	------	------	------	------	------	------	------	------	------	------

Custom Modifications

ADDTK	AUTH	CBO	CCO	CFNTD	CFRMO	CH	CND	CW	EXBK	EX	FB	FFD	FPEB	ID	INVRM	MIP	P	PFINBTMB	RD	TD	TVR_V
•	•	•	•	•	•	•	•	• ¹	•	•	•	•	•	•	•	•	•	•	•	•	• ²

Construction Upgrades

APC	PE
•	•

Door Options

ALF	CG	CG.BTM	CG.TOP	DPSRR	MD	MD.BTM	MD.TOP	MFO
•	•	•	•	•	• ³	•	•	•

¹ Not available on 24" and 48" (4 doors) wide

² Not available on 39", 42", 45", and 48" wide

³ Available only on 24", 27", 30", 33", 36", 42", 45", and 48" wide

WALL REFRIGERATOR SINGLE or DOUBLE DOOR, 24" HIGH, 24" DEEP

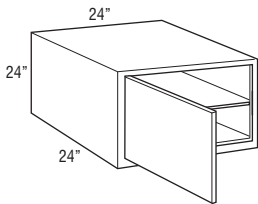

24", 27", 30", 31 1/2", 33", 34", 36", or 37"

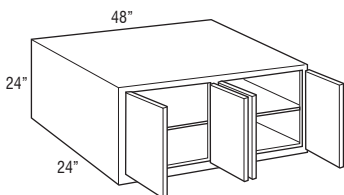
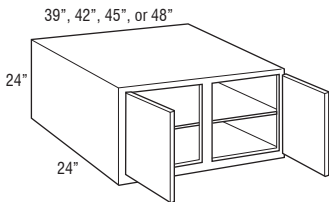
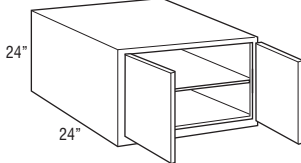

W242424 L or R	676	786	812	837	862	887	943	980	1021	1060	1089	1178
-----------------------	-----	-----	-----	-----	-----	-----	-----	-----	------	------	------	------

W242424	711	829	856	881	907	933	992	1032	1075	1113	1145	1238
W272424	746	861	889	916	944	971	1030	1071	1116	1155	1186	1285
W302424	780	893	922	951	980	1009	1068	1109	1155	1196	1229	1331
W31.52424	793	906	941	974	1008	1042	1105	1147	1194	1238	1270	1375
W332424	805	920	959	997	1035	1073	1141	1185	1233	1278	1312	1419
W342424	821	943	982	1020	1060	1098	1167	1211	1260	1307	1340	1450
W362424	839	968	1007	1045	1084	1122	1192	1239	1289	1333	1369	1483
W372424	881	1009	1048	1088	1127	1166	1238	1288	1340	1387	1422	1542

W392424	922	1051	1090	1129	1168	1207	1285	1335	1389	1440	1475	1600
W422424	935	1083	1136	1187	1239	1290	1371	1425	1482	1534	1576	1709
W452424	993	1142	1196	1250	1304	1357	1440	1495	1557	1613	1655	1796
W482424CS	1052	1200	1256	1310	1366	1421	1506	1566	1632	1689	1734	1882

W482424	1168	1315	1375	1435	1494	1553	1645	1708	1780	1842	1893	2054
----------------	------	------	------	------	------	------	------	------	------	------	------	------

- 24" deep cabinets must be fully supported by screws installed in a structural member in the ceiling or soffit, and into adjacent cabinets or tall panels.
- Load limit is 15 lbs. per square foot of load bearing surface.
- Shelf is 21" deep on W392424, W422424, W452424, W482424CS, and W482424 to allow for the shelf to be removed from the cabinet. Shelf will remain 21" if ID is selected on these cabinets.

Custom Modifications

ADDTK	AUTH	CBO	CCO	CFNTD	CFRMO	CH	CND	CW	EXBK	EX	FB	FFD	FPEB	ID	INVRM	MIP	P	PFINBTMB	RD	TD	TVR_V
•	•	•	•	•	•	•	•	• ¹	•	•	•	•	•	•	•	•	•	•	•	•	• ²

Construction Upgrades

APC	PE
•	•

Door Options

ALF	CG	CG.BTM	CG.TOP	DPSRR	MD	MD.BTM	MD.TOP	MFO
•	•	•	•	•	• ³	•	•	•

¹ Not available on 24" (2 doors) and 48" (4 doors) wide

² Not available on 39", 42", 45", and 48" wide

³ Available only on 24", 27", 30", 33", 36", 42", 45", and 48" wide

WALL REFRIGERATOR PULL-OUT, 24" HIGH, 24" DEEP

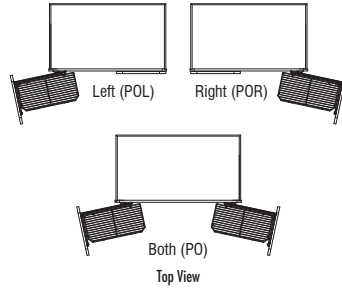
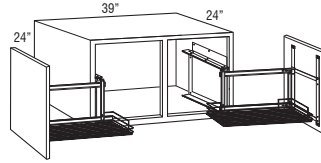
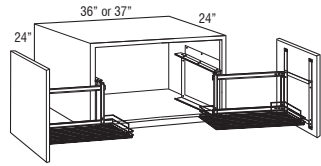

Price Point

	1	2	3	4	5	6	7	8	9	10	11	12
W362424PO L or R	2474	2603	2642	2680	2719	2757	2827	2874	2924	2968	3004	3118
W372424PO L or R	2516	2644	2683	2723	2762	2801	2873	2923	2975	3022	3057	3177
W362424PO	4109	4238	4277	4315	4354	4392	4462	4509	4559	4603	4639	4753
W372424PO	4151	4279	4318	4358	4397	4436	4508	4558	4610	4657	4692	4812

W392424PO L or R	2557	2686	2725	2764	2803	2842	2920	2970	3024	3075	3110	3235
W392424PO	4192	4321	4360	4399	4438	4477	4555	4605	4659	4710	4745	4870

- Door-mounted pull-out with a chrome wire rack that extends fully to the front of the cabinet then opens to the side for easy accessibility to contents. Designed for use above refrigerators or other high applications. Soft-close not included.
- Available installed in either the left side, right side, or both sides.
- For sufficient pull-out clearance, 13 1/8" of adjacent space is required for door to open fully when installed near a wall or corner.
- Chrome rack is 10" wide and 20 13/16" deep.
- 24" deep cabinets must be fully supported by screws installed in a structural member in the ceiling or soffit, and into adjacent cabinets or tall panels.
- Load limit is 20 lbs. per pull-out.

Custom Modifications

ADDTK	AUTH	CBO	CCO	CFNTO	CFRMO	CH	CND	CW	EXBK	EX	FB	FFD	FPEB	ID	INVFRM	MIP	P	PFINBTMB	RD	TD	TVR_V	
•	•		•			•			•	•	•		•			•		•				

Construction Upgrades

APC	PE
•	•

Door Options

ALF	CG	CG.BTM	CG.TOP	DPSRR	MD	MD.BTM	MD.TOP	MFO
				•				•

WALL SINGLE DOOR, 27" HIGH

9", 12", 15", 18", 21", or 24"

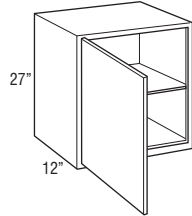

W927 L or R	438	494	517	539	562	584	618	642	667	692	710	768
W1227 L or R	447	504	528	550	573	596	631	655	681	706	724	784
W1527 L or R	472	532	556	579	603	625	664	687	718	744	764	827
W1827 L or R	495	559	585	609	635	660	699	725	755	781	802	869
W2127 L or R	523	588	615	642	669	694	737	763	795	823	847	916
W2427 L or R	550	619	647	674	702	729	775	804	837	866	888	965

Custom Modifications

ADDTK	AUTH	CBO	CCO	CFNTO	CFRMO	CH	CND	CW	EXBK	EX	FB	FFD	FPEB	ID	INVFRM	MIP	P	PFINBTMB	RD	TD	TVR_V	
•	•	•	•	•	•	•	•	• ¹	•	•	•	•	•	•	•	•	•	•	•	•	•	•

Construction Upgrades

APC	PE
•	•

Door Options

ALF	CG	CG.BTM	CG.TOP	DPSRR	MD	MD.BTM	MD.TOP	MFO
	•			•				•

¹ Not available on 9" wide

WALL DOUBLE DOOR, 27" HIGH

24", 27", 30", 33", 34", 36", or 37"

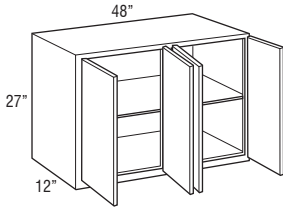
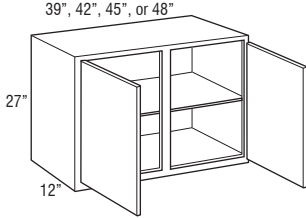
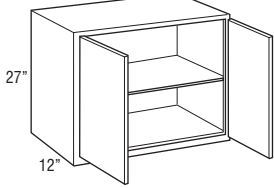

Price Point

	1	2	3	4	5	6	7	8	9	10	11	12
W2427	648	728	760	793	825	858	913	944	983	1019	1045	1133
W2727	680	766	801	836	870	905	960	995	1036	1073	1101	1194
W3027	710	799	834	869	904	939	999	1037	1080	1118	1147	1243
W3327	741	840	875	909	944	978	1037	1079	1120	1159	1194	1291
W3427	755	862	896	930	963	996	1057	1099	1141	1182	1216	1317
W3627	766	884	916	949	981	1014	1074	1118	1161	1202	1236	1340
W3727	784	902	936	970	1004	1037	1098	1141	1187	1230	1263	1370

W3927	801	922	956	991	1026	1061	1121	1165	1210	1257	1289	1398
W4227	832	960	996	1030	1066	1101	1167	1210	1258	1307	1341	1454
W4527	885	1019	1057	1095	1133	1170	1240	1288	1337	1387	1426	1547
W4827CS	935	1079	1119	1158	1198	1238	1314	1362	1416	1468	1508	1636

W4827	1040	1196	1242	1287	1333	1378	1458	1514	1572	1632	1677	1818
--------------	------	------	------	------	------	------	------	------	------	------	------	------

Custom Modifications

ADDTK	AUTH	CBO	CCO	CFNTO	CFRMO	CH	CND	CW	EXBK	EX	FB	FFD	FPEB	ID	INFRM	MIP	P	PFINBTMB	RD	TD	TVR_V
•	•	•	•	•	•	•	•	• ¹	•	•	•	•	•	•	•	•	•	•	•	•	• ²

Construction Upgrades

APC	PE
•	•

Door Options

ALF	CG	CG.BTM	CG.TOP	DPSRR	MD	MD.BTM	MD.TOP	MFO
•	•	•	•	•	•	•	•	•

¹ Not available on 24" and 48" (4 doors) wide
² Not available on 39", 42", 45", and 48" wide

WALL REFRIGERATOR SINGLE or DOUBLE DOOR, 27" HIGH, 24" DEEP

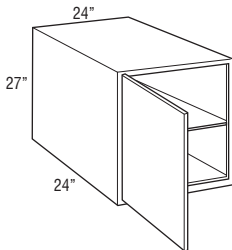

24", 27", 30", 33", 34", 36", or 37"

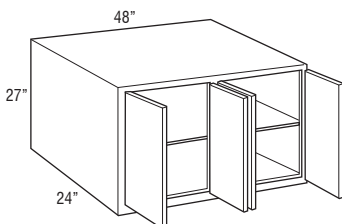
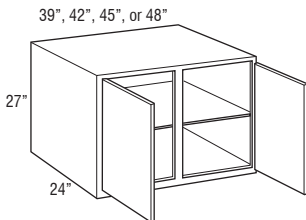
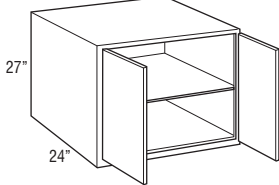

W242724 L or R	676	762	796	830	865	898	954	988	1028	1066	1094	1185
-----------------------	-----	-----	-----	-----	-----	-----	-----	-----	------	------	------	------

W242724	795	895	935	976	1016	1055	1121	1163	1210	1254	1287	1396
W272724	811	918	961	1004	1046	1089	1157	1200	1249	1292	1326	1437
W302724	828	939	984	1030	1076	1121	1191	1235	1286	1331	1366	1478
W332724	867	982	1023	1062	1101	1140	1206	1256	1304	1354	1390	1505
W342724	884	1010	1049	1088	1126	1164	1231	1279	1331	1380	1418	1536
W362724	897	1036	1074	1111	1148	1185	1253	1301	1355	1406	1446	1567
W372724	917	1057	1095	1133	1172	1210	1282	1332	1385	1437	1477	1599

W392724	935	1079	1118	1157	1196	1235	1310	1360	1416	1466	1506	1633
W422724	982	1131	1173	1214	1256	1297	1375	1428	1486	1539	1584	1714
W452724	1032	1187	1231	1275	1318	1362	1444	1500	1561	1616	1662	1799
W482724CS	1083	1248	1294	1340	1385	1430	1516	1575	1639	1697	1746	1888

W482724	1182	1360	1410	1459	1510	1559	1653	1716	1786	1850	1903	2059
----------------	------	------	------	------	------	------	------	------	------	------	------	------

- 24" deep cabinets must be fully supported by screws installed in a structural member in the ceiling or soffit, and into adjacent cabinets or tall panels.
- Load limit is 15 lbs. per square foot of load bearing surface.

Custom Modifications

ADDTK	AUTH	CBO	CCO	CFNTO	CFRMO	CH	CND	CW	EXBK	EX	FB	FFD	FPEB	ID	INFRM	MIP	P	PFINBTMB	RD	TD	TVR_V
•	•	•	•	•	•	•	•	• ¹	•	•	•	•	•	•	•	•	•	•	•	•	• ²

Construction Upgrades

APC	PE
•	•

Door Options

ALF	CG	CG.BTM	CG.TOP	DPSRR	MD	MD.BTM	MD.TOP	MFO
•	•	•	•	•	•	•	•	•

¹ Not available on 24" (2 doors) and 48" (4 doors) wide
² Not available on 39", 42", 45", and 48" wide

WALL SINGLE DOOR, 30" HIGH

9", 12", 15", 18", 21", or 24"

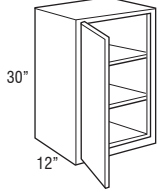

Price Point	1	2	3	4	5	6	7	8	9	10	11	12
W930 L or R	414	447	474	501	528	553	588	609	635	657	674	729
W1230 L or R	429	478	503	526	551	575	608	632	659	683	716	775
W1530 L or R	445	524	542	559	576	592	629	654	681	703	724	783
W1830 L or R	480	559	580	600	622	642	679	704	735	759	781	846
W2130 L or R	524	606	628	651	673	696	740	766	800	828	851	921
W2430 L or R	592	683	709	734	759	784	833	866	898	931	960	1039

Custom Modifications

ADDTK	AUTH	CBO	CCO	CFNTO	CFRMO	CH	CND	CW	EXBK	EX	FB	FFD	FPEB	ID	INVRM	MIP	P	PFINBTMB	RD	TD	TVR_V
•	•	•	•	•	•	•	•	• ¹	•	•	•	•	•	•	•	•	•	•	•	•	•

Construction Upgrades

APC	PE
•	•

Door Options

ALF	CG	CG.BTM	CG.TOP	DPSRR	MD	MD.BTM	MD.TOP	MFO
• ²	•			•	• ³			•

¹ Not available on 9" wide
² Not available on 9" and 24" wide
³ Not available on 9" and 12" wide

WALL DOUBLE DOOR, 30" HIGH

24", 27", 30", 33", or 36"

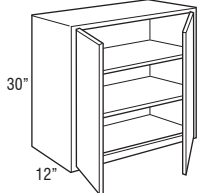

39", 42", 45", or 48"

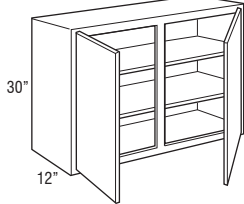

48"

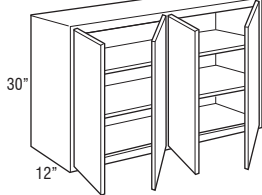

W2430	661	764	792	819	847	874	925	965	999	1038	1067	1156
W2730	702	811	844	877	911	943	1001	1040	1082	1121	1150	1247
W3030	737	853	886	917	950	981	1042	1082	1124	1164	1197	1296
W3330	773	890	926	962	998	1033	1095	1139	1185	1229	1261	1365
W3630	797	934	968	1001	1035	1068	1135	1177	1226	1272	1305	1412

W3930	811	916	965	1015	1064	1112	1180	1223	1273	1320	1355	1467
W4230	825	933	990	1047	1104	1161	1235	1286	1335	1383	1419	1539
W4530	899	1016	1077	1139	1201	1261	1340	1392	1449	1500	1539	1670
W4830CS	971	1098	1164	1229	1295	1360	1444	1500	1559	1616	1659	1799

W4830	1120	1266	1338	1411	1484	1556	1649	1715	1784	1846	1897	2059
--------------	------	------	------	------	------	------	------	------	------	------	------	------

Custom Modifications

ADDTK	AUTH	CBO	CCO	CFNTO	CFRMO	CH	CND	CW	EXBK	EX	FB	FFD	FPEB	ID	INVRM	MIP	P	PFINBTMB	RD	TD	TVR_V
•	•	•	•	•	•	•	•	• ¹	•	•	•	•	•	•	•	•	•	•	•	• ²	•

Construction Upgrades

APC	PE
•	•

Door Options

ALF	CG	CG.BTM	CG.TOP	DPSRR	MD	MD.BTM	MD.TOP	MFO
	•			•	• ³			•

¹ Not available on 24" and 48" (4 doors) wide
² Not available on 39", 42", 45", and 48" wide
³ Not available on 39" wide

WALL SINGLE DOOR, 33" HIGH

9", 12", 15", 18", 21", or 24"

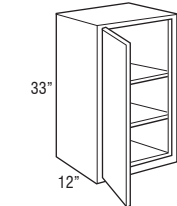

W933 L or R	463	506	533	560	587	613	651	674	702	726	747	808
W1233 L or R	483	538	564	591	618	644	679	693	736	764	793	858
W1533 L or R	503	586	606	626	646	665	707	731	764	790	810	878
W1833 L or R	539	626	650	672	696	718	764	791	827	853	877	952
W2133 L or R	587	680	706	731	757	782	831	862	896	928	956	1036
W2433 L or R	668	772	800	827	853	880	935	972	1009	1044	1076	1167

Custom Modifications

ADDTK	AUTH	CBO	CCO	CFNTO	CFRMO	CH	CND	CW	EXBK	EX	FB	FFD	FPEB	ID	INVRM	MIP	P	PFINBTMB	RD	TD	TVR_V
•	•	•	•	•	•	•	•	• ¹	•	•	•	•	•	•	•	•	•	•	•	•	•

Construction Upgrades

APC	PE
•	•

Door Options

ALF	CG	CG.BTM	CG.TOP	DPSRR	MD	MD.BTM	MD.TOP	MFO
	•			•	• ²			•

¹ Not available on 9" wide
² Not available on 9" and 12" wide

WALL DOUBLE DOOR, 33" HIGH

24", 27", 30", 33", or 36"

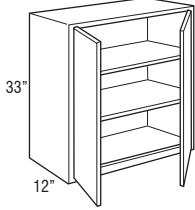

39", 42", 45", or 48"

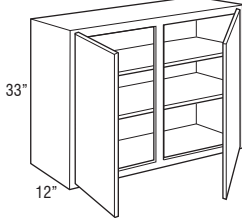

48"

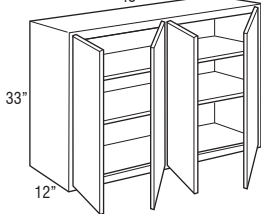

Price Point

	1	2	3	4	5	6	7	8	9	10	11	12
W2433	746	862	892	921	950	979	1038	1082	1123	1164	1196	1294
W2733	790	916	952	988	1024	1060	1122	1166	1211	1258	1289	1397
W3033	828	961	997	1032	1067	1102	1170	1213	1263	1310	1345	1458
W3333	867	999	1039	1079	1119	1158	1230	1277	1331	1378	1413	1531
W3633	896	1046	1085	1123	1161	1200	1276	1324	1378	1427	1466	1587

W3933	940	1095	1138	1179	1221	1262	1340	1391	1449	1501	1539	1667
W4233	969	1124	1167	1208	1250	1291	1374	1428	1485	1539	1580	1712
W4533	1056	1228	1273	1318	1364	1409	1495	1553	1615	1676	1719	1864
W4833CS	1144	1328	1378	1426	1475	1523	1616	1678	1746	1810	1858	2014

W4833	1316	1529	1585	1640	1695	1749	1855	1926	2007	2080	2135	2316
--------------	------	------	------	------	------	------	------	------	------	------	------	------

Custom Modifications

ADDTK	AUTH	CBO	CCO	CFNTO	CFRMO	CH	CND	CW	EXBK	EX	FB	FFD	FPEB	ID	INVFRM	MIP	P	PFINBTMB	RD	TD	TVR_V	
•	•	•	•	•	•	•	•	• ¹	•	•	•	•	•	•	•	•	•	•	•	•	•	•

Construction Upgrades

APC	PE
•	•

Door Options

ALF	CG	CG.BTM	CG.TOP	DPSRR	MD	MD.BTM	MD.TOP	MFO
•	•	•	•	•	• ²	•	•	•

¹ Not available on 24" and 48" (4 doors) wide

² Not available on 39" wide

WALL SINGLE DOOR, 36" HIGH

9", 12", 15", 18", 21", or 24"

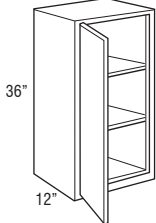

W936 L or R	508	567	594	619	645	671	712	740	767	797	819	886
W1236 L or R	535	598	627	655	683	711	753	783	812	847	868	939
W1536 L or R	561	647	670	692	715	737	782	811	844	875	899	972
W1836 L or R	599	697	722	747	773	797	847	879	917	945	973	1053
W2136 L or R	651	755	784	812	840	868	921	955	995	1030	1062	1149
W2436 L or R	740	859	888	917	946	976	1037	1079	1118	1158	1194	1291

Custom Modifications

ADDTK	AUTH	CBO	CCO	CFNTO	CFRMO	CH	CND	CW	EXBK	EX	FB	FFD	FPEB	ID	INVFRM	MIP	P	PFINBTMB	RD	TD	TVR_V	
•	•	•	•	•	•	•	•	• ¹	•	•	•	•	•	•	•	•	•	•	•	•	•	•

Construction Upgrades

APC	PE
•	•

Door Options

ALF	CG	CG.BTM	CG.TOP	DPSRR	MD	MD.BTM	MD.TOP	MFO
• ²	•	•	•	•	• ³	•	•	•

¹ Not available on 9" wide

² Not available on 9" and 24" wide

³ Not available on 9" and 12" wide

WALL DOUBLE DOOR, 36" HIGH

24", 27", 30", 33", or 36"

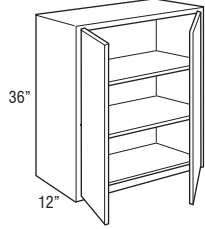

39", 42", 45", or 48"

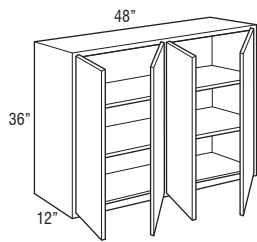
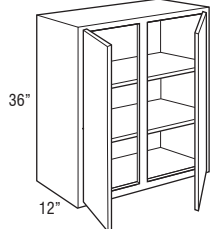

Price Point	1	2	3	4	5	6	7	8	9	10	11	12
W2436	831	962	993	1024	1054	1084	1149	1197	1243	1288	1325	1436
W2736	879	1019	1057	1095	1133	1170	1241	1291	1342	1392	1427	1547
W3036	917	1063	1103	1144	1184	1224	1297	1348	1402	1454	1495	1621
W3336	962	1110	1154	1197	1241	1285	1364	1418	1476	1528	1568	1695
W3636	996	1157	1202	1245	1289	1333	1412	1468	1529	1584	1627	1763
W3936	1056	1229	1275	1320	1366	1412	1499	1556	1621	1680	1725	1866
W4236	1068	1240	1286	1332	1378	1422	1512	1571	1636	1693	1739	1887
W4536	1166	1353	1403	1454	1504	1553	1649	1715	1785	1850	1898	2059
W4836CS	1262	1464	1520	1575	1630	1684	1786	1858	1933	2004	2057	2230
W4836	1457	1691	1755	1819	1883	1945	2062	2141	2231	2315	2374	2570

Custom Modifications

ADDTK	AUTH	CBO	CCO	CFNTO	CFRMO	CH	CND	CW	EXBK	EX	FB	FFD	FPEB	ID	INVFRM	MIP	P	PFINBTMB	RD	TD	TVR_V	
•	•	•	•	•	•	•	•	• ¹	•	•	•	•	•	•	•	•	•	•	•	•	•	•

Construction Upgrades

APC	PE
•	•

Door Options

ALF	CG	CG.BTM	CG.TOP	DPSRR	MD	MD.BTM	MD.TOP	MFO
•	•	•	•	•	• ²	•	•	•

¹ Not available on 24" and 48" (4 doors) wide
² Not available on 39" wide

WALL SINGLE DOOR, 39" HIGH

9", 12", 15", 18", 21" or 24"

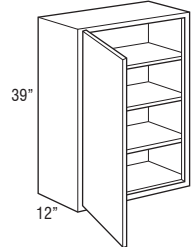

W939 L or R	560	624	653	681	710	738	783	813	842	876	902	974
W1239 L or R	588	657	689	720	752	782	829	862	893	928	956	1036
W1539 L or R	617	710	736	760	785	810	861	893	930	962	987	1070
W1839 L or R	660	766	794	821	849	876	928	969	1007	1042	1071	1158
W2139 L or R	713	831	862	894	925	956	1014	1052	1095	1132	1168	1264
W2439 L or R	813	941	974	1008	1042	1074	1140	1186	1233	1277	1314	1420

Custom Modifications

ADDTK	AUTH	CBO	CCO	CFNTO	CFRMO	CH	CND	CW	EXBK	EX	FB	FFD	FPEB	ID	INVFRM	MIP	P	PFINBTMB	RD	TD	TVR_V	
•	•	•	•	•	•	•	•	• ¹	•	•	•	•	•	•	•	•	•	•	•	•	•	•

Construction Upgrades

APC	PE
•	•

Door Options

ALF	CG	CG.BTM	CG.TOP	DPSRR	MD	MD.BTM	MD.TOP	MFO
•	•	•	•	•	• ²	•	•	•

¹ Not available on 9" wide
² Not available on 9" and 12" wide

WALL DOUBLE DOOR, 39" HIGH

24", 27", 30", 33", or 36"

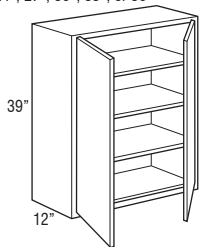

39", 42", 45", or 48"

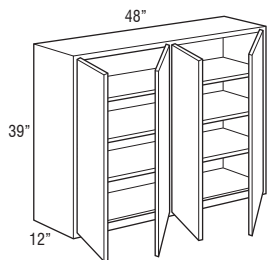
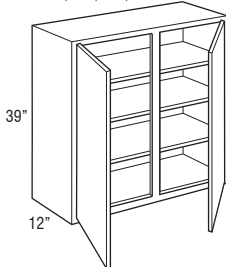

Price Point

	1	2	3	4	5	6	7	8	9	10	11	12
W2439	915	1055	1090	1124	1159	1193	1266	1319	1368	1417	1460	1580
W2739	969	1118	1160	1202	1244	1286	1366	1419	1477	1531	1571	1701
W3039	1007	1169	1214	1258	1301	1345	1427	1482	1542	1599	1642	1781
W3339	1055	1222	1270	1317	1365	1412	1501	1558	1621	1681	1723	1866
W3639	1096	1275	1323	1370	1418	1465	1553	1615	1681	1743	1789	1936

W3939	1163	1351	1402	1453	1503	1553	1646	1710	1785	1846	1896	2054
W4239	1173	1364	1416	1466	1518	1568	1661	1729	1798	1865	1912	2075
W4539	1280	1487	1543	1599	1655	1710	1813	1886	1963	2035	2087	2262
W4839CS	1388	1611	1671	1732	1792	1851	1966	2045	2128	2205	2261	2452

W4839	1602	1859	1930	1999	2070	2139	2268	2358	2454	2546	2610	2828
--------------	------	------	------	------	------	------	------	------	------	------	------	------

Custom Modifications

ADDTK	AUTH	CBO	CCO	CFNTO	CFRMO	CH	CND	CW	EXBK	EX	FB	FFD	FPEB	ID	INVFRM	MIP	P	PFINBTMB	RD	TD	TVR_V	
•	•	•	•	•	•	•	•	• ¹	•	•	•	•	•	•	•	•	•	•	•	•	•	•

Construction Upgrades

APC	PE
•	•

Door Options

ALF	CG	CG.BTM	CG.TOP	DPSRR	MD	MD.BTM	MD.TOP	MFO
•	•	•	•	•	• ²	•	•	•

¹ Not available on 24" and 48" (4 doors) wide

² Not available on 39" wide

WALL SINGLE DOOR, 42" HIGH

9", 12", 15", 18", 21", or 24"

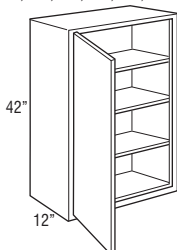

W942 L or R	609	681	712	744	775	805	856	889	926	959	984	1068
W1242 L or R	641	713	750	787	824	860	913	945	986	1020	1048	1137
W1542 L or R	678	788	813	837	861	885	939	977	1018	1053	1081	1170
W1842 L or R	720	837	867	896	926	955	1010	1051	1091	1132	1159	1257
W2142 L or R	781	908	942	976	1009	1043	1105	1150	1196	1238	1275	1378
W2442 L or R	887	1028	1065	1101	1138	1174	1244	1292	1344	1392	1432	1551

Custom Modifications

ADDTK	AUTH	CBO	CCO	CFNTO	CFRMO	CH	CND	CW	EXBK	EX	FB	FFD	FPEB	ID	INVFRM	MIP	P	PFINBTMB	RD	TD	TVR_V	
•	•	•	•	•	•	•	•	• ¹	•	•	•	•	•	•	•	•	•	•	•	•	•	•

Construction Upgrades

APC	PE
•	•

Door Options

ALF	CG	CG.BTM	CG.TOP	DPSRR	MD	MD.BTM	MD.TOP	MFO
•	•	•	•	•	• ²	•	•	•

¹ Not available on 9" wide

² Not available on 9" and 12" wide

WALL DOUBLE DOOR, 42" HIGH

24", 27", 30", 33", or 36"

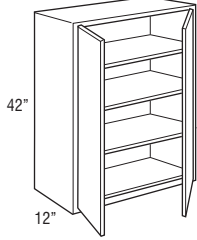

39", 42", 45", or 48"

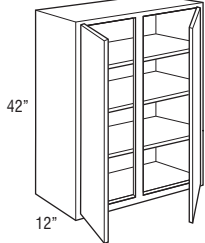

48"

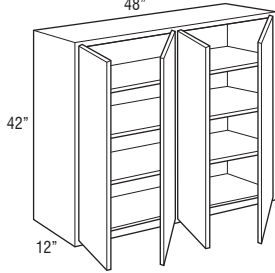

Price Point

	1	2	3	4	5	6	7	8	9	10	11	12
W2442	993	1150	1188	1226	1264	1303	1382	1434	1490	1547	1590	1725
W2742	1054	1216	1264	1312	1359	1406	1491	1549	1612	1672	1719	1861
W3042	1095	1273	1323	1371	1420	1468	1558	1618	1683	1745	1792	1941
W3342	1150	1327	1382	1436	1491	1544	1639	1704	1772	1837	1888	2045
W3642	1196	1381	1437	1492	1548	1603	1701	1764	1838	1904	1954	2118
W3942	1266	1464	1523	1581	1640	1698	1802	1868	1949	2023	2075	2244
W4242	1279	1480	1539	1597	1655	1714	1820	1889	1966	2041	2092	2268
W4542	1397	1613	1678	1742	1807	1870	1987	2062	2144	2228	2285	2475
W4842CS	1513	1748	1819	1888	1958	2027	2150	2233	2323	2412	2475	2681
W4842	1745	2017	2098	2178	2259	2340	2482	2576	2681	2782	2855	3093

Custom Modifications

ADDTK	AUTH	CBO	CCO	CFNTO	CFRMO	CH	CND	CW	EXBK	EX	FB	FFD	FPEB	ID	INVFRM	MIP	P	PFINBTMB	RD	TD	TVR_V	
•	•	•	•	•	•	•	•	• ¹	•	•	•	•	•	•	•	•	•	•	•	•	•	•

Construction Upgrades

APC	PE
•	•

Door Options

ALF	CG	CG.BTM	CG.TOP	DPSRR	MD	MD.BTM	MD.TOP	MFO
•	•	•	•	•	• ²	•	•	•

¹ Not available on 24" and 48" (4 doors) wide
² Not available on 39" wide

WALL TWO DRAWER CABINET, 18" HIGH, 12" DEEP

12", 15", 18", 21", 24", 27", 30", 33", or 36"

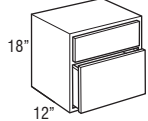

W2D1218	859	864	876	888	900	913	943	971	991	1010	1027	1085
W2D1518	950	954	970	984	999	1014	1047	1079	1103	1122	1141	1204
W2D1818	990	995	1014	1032	1049	1067	1103	1137	1161	1183	1202	1272
W2D2118	1035	1040	1061	1081	1101	1121	1160	1194	1223	1245	1268	1338
W2D2418	1089	1094	1111	1128	1145	1160	1204	1239	1270	1291	1318	1392
W2D2718	1154	1159	1177	1195	1213	1230	1277	1314	1344	1370	1397	1475
W2D3018	1217	1223	1242	1261	1280	1298	1348	1388	1420	1448	1477	1558
W2D3318	1286	1292	1313	1332	1351	1370	1421	1460	1497	1525	1553	1641
W2D3618	1350	1356	1378	1398	1419	1439	1493	1537	1572	1603	1634	1726

Custom Modifications

ADDTK	AUTH	CBO	CCO	CFNTO	CFRMO	CH	CND	CW	EXBK	EX	FB	FFD	FPEB	ID	INVFRM	MIP	P	PFINBTMB	RD	TD	TVR_V	
•	•	•	•	•	•	•	•	• ¹	•	•	•	•	•	•	•	•	•	•	•	•	•	•

Construction Upgrades

APC	PE
•	•

Door Options

ALF	CG	CG.BTM	CG.TOP	DPSRR	MD	MD.BTM	MD.TOP	MFO
•	•	•	•	•	•	•	•	•

¹ Not available on 12" wide

WALL TWO DRAWER SINGLE DOOR CABINET, 48", 51", 54", 57", or 60" HIGH, 12" DEEP

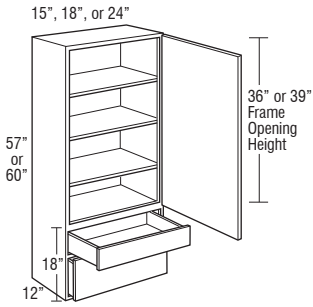
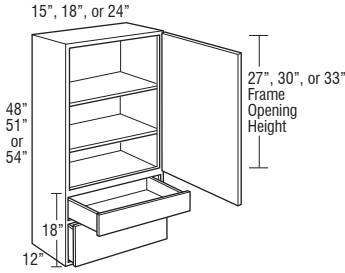

	Price Point	1	2	3	4	5	6	7	8	9	10	11	12
W2D1548 L or R	1103	1187	1279	1371	1463	1555	1648	1712	1782	1845	1896	2057	
W2D1848 L or R	1183	1266	1363	1460	1558	1655	1754	1822	1897	1966	2018	2187	
W2D2448 L or R	1366	1464	1578	1692	1807	1921	2034	2112	2199	2279	2340	2536	
W2D1551 L or R	1166	1253	1348	1444	1539	1633	1733	1800	1872	1939	1994	2160	
W2D1851 L or R	1247	1342	1441	1541	1641	1739	1845	1917	1992	2064	2120	2299	
W2D2451 L or R	1455	1564	1680	1795	1912	2027	2150	2236	2323	2412	2475	2679	
W2D1554 L or R	1229	1320	1419	1516	1614	1711	1817	1888	1962	2032	2090	2262	
W2D1854 L or R	1312	1418	1520	1622	1724	1824	1936	2013	2090	2166	2225	2412	
W2D2454 L or R	1540	1659	1779	1898	2018	2138	2268	2356	2448	2542	2608	2825	
W2D1557 L or R	1334	1434	1541	1649	1756	1863	1975	2052	2134	2210	2272	2461	
W2D1857 L or R	1428	1541	1652	1763	1874	1985	2107	2187	2274	2354	2420	2621	
W2D2457 L or R	1674	1805	1935	2065	2195	2325	2467	2565	2664	2762	2836	3072	
W2D1560 L or R	1355	1475	1576	1676	1776	1876	1989	2066	2149	2228	2290	2477	
W2D1860 L or R	1439	1566	1673	1780	1887	1994	2113	2196	2284	2367	2432	2635	
W2D2460 L or R	1710	1860	1986	2110	2236	2360	2504	2601	2706	2806	2880	3121	

Custom Modifications

ADDTK	AUTH	CBO	CCO	CFNTO	CFRMO	CH	CND	CW	EXBK	EX	FB	FFD	FPEB	ID	INVRM	MIP	P	PFINBTMB	RD	TD	TVR_V	
•	•	•	•		•	• ¹	• ²	•	•	•	•		•	•		•						

Construction Upgrades

APC	PE
•	•

Door Options

ALF	CG	CG.BTM	CG.TOP	DPSRR	MD	MD.BTM	MD.TOP	MFO
•	•			•	•			•

¹ Not available on 48" high

² Not available on 15" wide

WALL TWO DRAWER DOUBLE DOOR CABINET, 48", 51", 54", 57", or 60" HIGH, 12" DEEP

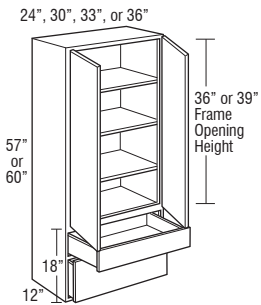
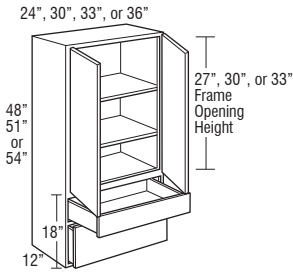

W2D2448	1437	1542	1662	1781	1901	2019	2144	2224	2315	2398	2462	2668
W2D3048	1608	1726	1860	1994	2128	2261	2399	2491	2593	2686	2757	2988
W2D3348	1695	1818	1960	2101	2242	2383	2528	2625	2731	2830	2904	3147
W2D3648	1781	1911	2060	2208	2356	2504	2658	2759	2869	2974	3052	3307
W2D2451	1530	1645	1768	1891	2013	2135	2265	2353	2447	2538	2605	2820
W2D3051	1714	1841	1979	2117	2255	2392	2538	2635	2742	2841	2918	3160
W2D3351	1807	1942	2087	2231	2376	2519	2673	2776	2888	2995	3074	3329
W2D3651	1898	2040	2192	2344	2496	2648	2809	2916	3035	3146	3229	3497
W2D2454	1620	1748	1875	2000	2126	2251	2387	2481	2578	2673	2746	2974
W2D3054	1816	1959	2100	2240	2380	2520	2673	2778	2888	2993	3077	3331
W2D3354	1912	2063	2212	2360	2509	2657	2817	2928	3042	3155	3241	3510
W2D3654	2008	2168	2324	2480	2635	2791	2959	3076	3198	3314	3406	3688
W2D2457	1763	1901	2038	2175	2312	2448	2597	2698	2804	2910	2987	3235
W2D3057	1973	2128	2283	2436	2589	2743	2909	3021	3142	3259	3344	3623
W2D3357	2080	2240	2402	2565	2727	2888	3064	3184	3310	3433	3525	3817
W2D3657	2185	2356	2527	2696	2866	3035	3220	3345	3478	3608	3704	4011
W2D2460	1801	1959	2090	2221	2352	2483	2638	2742	2848	2955	3031	3286
W2D3060	2017	2193	2341	2488	2634	2781	2953	3070	3191	3308	3395	3680
W2D3360	2126	2312	2467	2622	2776	2931	3112	3235	3362	3485	3576	3877
W2D3660	2234	2428	2592	2754	2918	3080	3269	3398	3531	3662	3758	4075

Custom Modifications

ADDTK	AUTH	CBO	CCO	CFNTO	CFRMO	CH	CND	CW	EXBK	EX	FB	FFD	FPEB	ID	INVRM	MIP	P	PFINBTMB	RD	TD	TVR_V	
•	•	•	•		•	• ¹	• ²	•	•	•	•		•	•		•						

Construction Upgrades

APC	PE
•	•

Door Options

ALF	CG	CG.BTM	CG.TOP	DPSRR	MD	MD.BTM	MD.TOP	MFO
•	•			•	•			•

¹ Not available on 48" high

² Not available on 24" wide

WALL THREE DRAWER SINGLE DOOR, 48", 51", 54", 57", or 60" HIGH

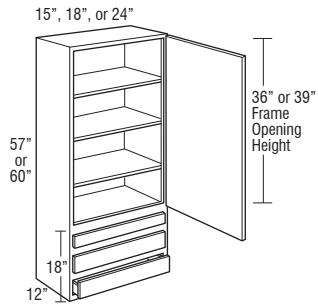
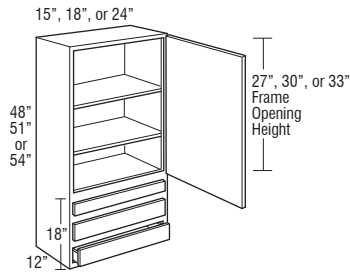

Price Point	1	2	3	4	5	6	7	8	9	10	11	12
W3D1548 L or R	1103	1187	1279	1371	1463	1555	1648	1712	1782	1845	1896	2057
W3D1848 L or R	1183	1266	1363	1460	1558	1655	1754	1822	1897	1966	2018	2187
W3D2448 L or R	1366	1464	1578	1692	1807	1921	2034	2112	2199	2279	2340	2536
W3D1551 L or R	1166	1253	1348	1444	1539	1633	1733	1800	1872	1939	1994	2160
W3D1851 L or R	1247	1342	1441	1541	1641	1739	1845	1917	1992	2064	2120	2299
W3D2451 L or R	1455	1564	1680	1795	1912	2027	2150	2236	2323	2412	2475	2679
W3D1554 L or R	1229	1320	1419	1516	1614	1711	1817	1888	1962	2032	2090	2262
W3D1854 L or R	1312	1418	1520	1622	1724	1824	1936	2013	2090	2166	2225	2412
W3D2454 L or R	1540	1659	1779	1898	2018	2138	2268	2356	2448	2542	2608	2825

W3D1557 L or R	1334	1434	1541	1649	1756	1863	1975	2052	2134	2210	2272	2461
W3D1857 L or R	1428	1541	1652	1763	1874	1985	2107	2187	2274	2354	2420	2621
W3D2457 L or R	1674	1805	1935	2065	2195	2325	2467	2565	2664	2762	2836	3072
W3D1560 L or R	1355	1475	1576	1676	1776	1876	1989	2066	2149	2228	2290	2477
W3D1860 L or R	1439	1566	1673	1780	1887	1994	2113	2196	2284	2367	2432	2635
W3D2460 L or R	1710	1860	1986	2110	2236	2360	2504	2601	2706	2806	2880	3121

- Includes one shallow depth drawer and two standard drawers.
- Top drawer will be slab drawer front for all 5-piece drawer applications.
- Drawer front to face frame reveal is justified to the top to be consistent with both full and partial overlay. Bottom reveal is 7/8" for full overlay and 1" for partial overlay.

Custom Modifications

ADDTK	AUTH	CBO	CCO	CFNTO	CFRMO	CH	CND	CW	EXBK	EX	FB	FFD	FPEB	ID	INVFRM	MIP	P	PFINBTMB	RD	TD	TVR_V	
•	•	•	•		•	• ¹	•	• ²	•	•	•		•	•		•						

Construction Upgrades

APC	PE
•	•

Door Options

ALF	CG	CG.BTM	CG.TOP	DPSRR	MD	MD.BTM	MD.TOP	MFO
	•			•	•			•

¹ Not available on 48" high
² Not available on 15" wide

WALL THREE DRAWER DOUBLE DOOR, 48", 51", 54", 57", or 60" HIGH

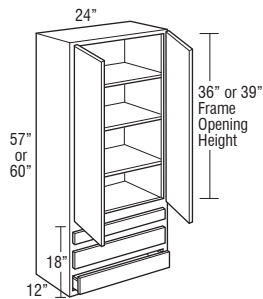
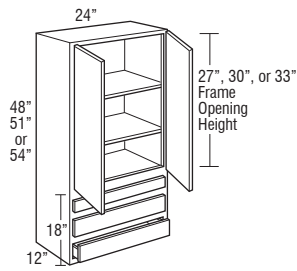

W3D2448	1437	1542	1662	1781	1901	2019	2144	2224	2315	2398	2462	2668
W3D2451	1530	1645	1768	1891	2013	2135	2265	2353	2447	2538	2605	2820
W3D2454	1620	1748	1875	2000	2126	2251	2387	2481	2578	2673	2746	2974

W3D2457	1763	1901	2038	2175	2312	2448	2597	2698	2804	2910	2987	3235
W3D2460	1801	1959	2090	2221	2352	2483	2638	2742	2848	2955	3031	3286

- Includes one shallow depth drawer and two standard drawers.
- Top drawer will be slab drawer front for all 5-piece drawer applications.
- Drawer front to face frame reveal is justified to the top to be consistent with both full and partial overlay. Bottom reveal is 7/8" for full overlay and 1" for partial overlay.

Custom Modifications

ADDTK	AUTH	CBO	CCO	CFNTO	CFRMO	CH	CND	CW	EXBK	EX	FB	FFD	FPEB	ID	INVFRM	MIP	P	PFINBTMB	RD	TD	TVR_V	
•	•	•	•		•	• ¹	•		•	•	•		•	•		•						

Construction Upgrades

APC	PE
•	•

Door Options

ALF	CG	CG.BTM	CG.TOP	DPSRR	MD	MD.BTM	MD.TOP	MFO
	•			•	•			•

¹ Not available on 48" high

STACKED WALL CABINETS SINGLE DOOR, 48", 51", 54", 57", or 60" HIGH

12", 15", 18", 21", or 24"

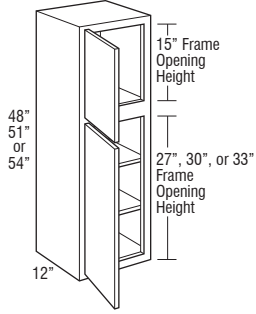

12", 15", 18", 21", or 24"

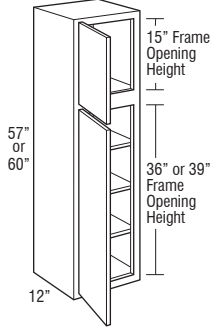

Price Point

	1	2	3	4	5	6	7	8	9	10	11	12
STW1248 L or R	1204	1324	1368	1410	1453	1495	1567	1587	1671	1712	1767	1897
STW1548 L or R	1245	1398	1436	1474	1512	1549	1623	1674	1732	1776	1817	1953
STW1848 L or R	1307	1465	1508	1549	1592	1633	1714	1770	1828	1879	1923	2064
STW2148 L or R	1371	1539	1586	1633	1680	1726	1811	1872	1933	1989	2034	2188
STW2448 L or R	1440	1621	1671	1720	1771	1820	1907	1976	2041	2102	2149	2316
STW1251 L or R	1256	1381	1427	1472	1518	1562	1636	1676	1746	1795	1842	1982
STW1551 L or R	1303	1460	1502	1542	1583	1623	1698	1755	1816	1863	1903	2050
STW1851 L or R	1369	1537	1580	1624	1668	1711	1799	1858	1919	1972	2018	2169
STW2151 L or R	1432	1612	1662	1711	1762	1811	1902	1968	2032	2090	2141	2304
STW2451 L or R	1516	1708	1761	1812	1864	1915	2010	2082	2152	2213	2267	2442
STW1254 L or R	1307	1439	1487	1536	1584	1631	1710	1765	1823	1877	1921	2062
STW1554 L or R	1361	1520	1564	1606	1649	1691	1775	1833	1897	1949	1991	2143
STW1854 L or R	1429	1603	1650	1696	1743	1789	1880	1947	2008	2064	2115	2274
STW2154 L or R	1494	1690	1743	1794	1846	1897	1992	2063	2130	2192	2244	2419
STW2454 L or R	1589	1796	1850	1904	1958	2010	2112	2188	2260	2326	2384	2568

75

STW1257 L or R	1361	1500	1551	1602	1652	1702	1785	1845	1906	1959	2007	2157
STW1557 L or R	1418	1586	1632	1677	1723	1767	1852	1914	1979	2034	2080	2239
STW1857 L or R	1487	1672	1721	1771	1820	1869	1963	2033	2100	2160	2211	2379
STW2157 L or R	1560	1763	1819	1875	1931	1986	2083	2157	2229	2294	2351	2532
STW2457 L or R	1663	1880	1939	1996	2053	2110	2214	2297	2371	2443	2504	2697
STW1260 L or R	1418	1557	1613	1669	1725	1780	1869	1928	1998	2053	2102	2259
STW1560 L or R	1480	1663	1708	1752	1796	1840	1933	1998	2068	2128	2173	2337
STW1860 L or R	1548	1744	1795	1846	1896	1947	2045	2116	2184	2251	2300	2477
STW2160 L or R	1626	1840	1898	1957	2015	2072	2177	2258	2330	2398	2457	2645
STW2460 L or R	1737	1967	2027	2088	2148	2208	2322	2406	2484	2560	2623	2826

Custom Modifications

ADDTK	AUTH	CBO	CCO	CFNTO	CFRMO	CH	CND	CW	EXBK	EX	FB	FFD	FPEB	ID	INFRM	MIP	P	PFINBTMB	RD	TD	TVR_V
•	•	•	•	•	•	• ¹	• ²	•	•	•	•	•	•	•	•	•	•	•	•	•	•

Construction Upgrades

APC	PE
•	•

Door Options

ALF	CG	CG.BTM	CG.TOP	DPSRR	MD	MD.BTM	MD.TOP	MFO
•	•	•	•	•	•	• ²	• ²	•

¹ Not available on 48" high

² Not available on 12" wide

STACKED WALL CABINETS DOUBLE DOOR, 48", 51", 54", 57", or 60" HIGH

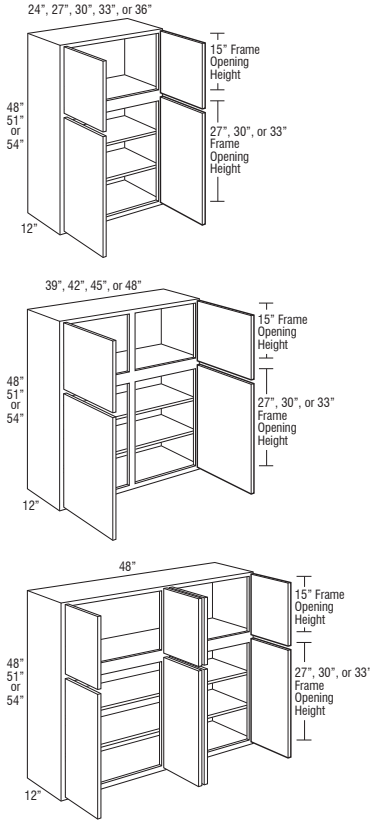

Price Point	1	2	3	4	5	6	7	8	9	10	11	12
STW2448	1515	1705	1757	1809	1860	1912	2009	2081	2147	2211	2265	2438
STW2748	1569	1766	1823	1880	1938	1994	2096	2168	2241	2306	2362	2546
STW3048	1622	1827	1884	1941	1998	2055	2159	2233	2312	2377	2435	2623
STW3348	1689	1905	1967	2027	2088	2148	2259	2340	2418	2492	2550	2750
STW3648	1729	1961	2022	2082	2143	2203	2323	2400	2484	2560	2616	2822
STW2451	1599	1803	1857	1911	1964	2018	2119	2197	2268	2336	2395	2578
STW2751	1658	1868	1929	1988	2047	2107	2215	2293	2372	2442	2501	2695
STW3051	1711	1931	1992	2053	2113	2174	2290	2367	2448	2519	2583	2783
STW3351	1782	2015	2080	2144	2209	2272	2393	2477	2566	2642	2703	2915
STW3651	1829	2073	2139	2204	2270	2335	2461	2545	2638	2717	2780	2997
STW2454	1683	1902	1957	2012	2066	2121	2234	2316	2390	2462	2521	2719
STW2754	1748	1972	2034	2094	2156	2216	2335	2417	2502	2576	2640	2844
STW3054	1801	2038	2103	2167	2231	2295	2417	2501	2587	2664	2729	2942
STW3354	1874	2126	2194	2262	2331	2398	2529	2619	2710	2792	2856	3081
STW3654	1926	2185	2257	2327	2398	2468	2601	2690	2788	2871	2939	3172

STW3948	1786	2019	2087	2153	2219	2285	2405	2484	2572	2654	2712	2922
STW4248	1851	2096	2164	2232	2300	2368	2492	2582	2673	2752	2818	3040
STW4548	1977	2242	2315	2388	2461	2532	2667	2762	2860	2947	3021	3256
STW4848CS	2106	2390	2467	2544	2620	2696	2839	2942	3048	3142	3219	3472
STW3951	1902	2154	2224	2295	2365	2435	2564	2651	2746	2834	2896	3123
STW4251	1951	2211	2284	2355	2427	2499	2630	2725	2825	2910	2978	3214
STW4551	2089	2370	2447	2523	2601	2677	2821	2925	3031	3124	3199	3451
STW4851CS	2225	2530	2613	2695	2776	2858	3012	3121	3237	3336	3418	3690
STW3954	2017	2285	2361	2436	2511	2586	2723	2816	2918	3012	3080	3321
STW4254	2048	2325	2401	2476	2552	2628	2768	2868	2971	3065	3138	3389
STW4554	2196	2495	2578	2660	2743	2825	2975	3084	3196	3297	3378	3646
STW4854CS	2344	2667	2756	2845	2933	3022	3183	3301	3422	3530	3615	3904

STW4848	2360	2686	2771	2856	2941	3025	3185	3302	3419	3528	3616	3904
STW4851	2501	2846	2939	3032	3125	3218	3395	3517	3644	3761	3853	4162
STW4854	2638	3007	3109	3210	3312	3413	3600	3731	3868	3994	4092	4420

Custom Modifications

ADDTK	AUTH	CBO	CCO	CFNTO	CFRMO	CH	CND	CW	EXBK	EX	FB	FFD	FPEB	ID	INVFRM	MIP	P	PFINBTMB	RD	TD	TVR_V
•	•	•	•	•	•	• ¹		• ²	•	•	•	•	•	•	•	• ³	•	•	•	• ³	

Construction Upgrades

APC	PE
•	•

Door Options

ALF	CG	CG.BTM	CG.TOP	DPSRR	MD	MD.BTM	MD.TOP	MFO
		•	•	•		• ⁴	• ⁴	•

¹ Not available on 48" high
² Not available on 24" and 48" (4 doors) wide
³ Not available on 39", 42", 45", and 48" wide
⁴ Not available on 39" wide

STACKED WALL CABINETS DOUBLE DOOR, 48", 51", 54", 57", or 60" HIGH (cont'd)

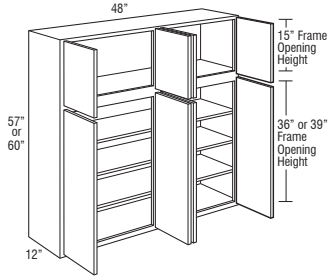
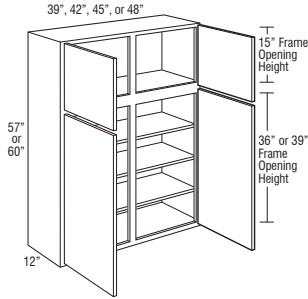
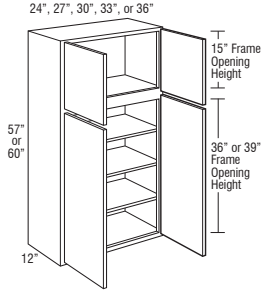

Price Point

	1	2	3	4	5	6	7	8	9	10	11	12
STW2457	1766	1998	2057	2117	2176	2234	2348	2437	2512	2594	2657	2864
STW2757	1837	2075	2140	2205	2270	2334	2460	2546	2636	2718	2781	2998
STW3057	1895	2143	2212	2281	2351	2419	2547	2635	2726	2811	2880	3106
STW3357	1970	2234	2308	2382	2456	2529	2664	2759	2856	2942	3012	3251
STW3657	2028	2300	2377	2452	2527	2602	2743	2838	2942	3030	3102	3347
STW2460	1848	2091	2154	2216	2279	2342	2463	2554	2638	2720	2787	3005
STW2760	1922	2173	2243	2314	2384	2454	2583	2679	2774	2856	2929	3158
STW3060	1979	2248	2322	2396	2470	2542	2676	2773	2868	2958	3028	3268
STW3360	2066	2341	2421	2501	2580	2660	2803	2904	3007	3100	3177	3428
STW3660	2130	2408	2492	2575	2659	2742	2886	2989	3098	3191	3268	3529

STW3957	2125	2408	2488	2567	2647	2726	2871	2971	3081	3181	3254	3509
STW4257	2157	2449	2530	2611	2691	2772	2919	3027	3135	3235	3311	3576
STW4557	2315	2633	2720	2807	2893	2979	3142	3257	3375	3483	3566	3852
STW4857CS	2472	2813	2908	3000	3095	3188	3362	3485	3614	3731	3821	4127
STW3960	2225	2523	2611	2697	2783	2869	3027	3132	3246	3357	3431	3699
STW4260	2262	2567	2656	2743	2831	2919	3078	3186	3302	3409	3490	3770
STW4560	2429	2759	2855	2950	3046	3142	3312	3431	3557	3674	3761	4062
STW4860CS	2595	2950	3054	3157	3260	3363	3548	3676	3810	3938	4033	4356

STW4857	2784	3177	3285	3392	3500	3606	3802	3945	4092	4226	4329	4676
STW4860	2931	3335	3453	3571	3688	3806	4017	4165	4319	4464	4572	4939

Custom Modifications

ADDTK	AUTH	CBO	CCO	CFNTO	CFRMO	CH	CND	CW	EXBK	EX	FB	FFD	FPEB	ID	INFRM	MIP	P	PFINBTMB	RD	TD	TVR_V
•	•	•	•	•	•	•	•	• ¹	•	•	•	•	•	•	•	•	• ²	•	•	• ²	

Construction Upgrades

APC	PE
•	•

Door Options

ALF	CG	CG.BTM	CG.TOP	DPSRR	MD	MD.BTM	MD.TOP	MFO
		•	•	•			• ³	• ³

¹ Not available on 24" and 48" (4 doors) wide
² Not available on 39", 42", 45", and 48" wide
³ Not available on 39" wide

Wall Corner Cabinets

- Wall corner cabinets may be installed flush to the wall (left) or pulled up to 3" away from wall (right) to accommodate odd dimensions in a kitchen design. In either case, the adjoining run of 12" wall cabinets plus a 3" filler will butt against the solid-wood panel.
- When a cabinet is "pulled" it will use proportionally more wall space, for example, a 30" wide WC pulled 2" will use 32" of space.
- The L or R in the cabinet's nomenclature indicates the location of cabinet void.
- Blind side of wall corner cabinets cannot be installed next to a range hood or microwave shelf unit due to door interference.

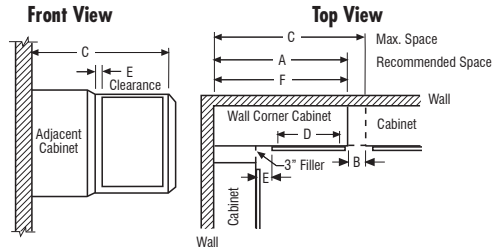

NOTE: All outside stiles are 1 1/2" wide

Model	A Recommended Space	B Max. Pull ¹	C Max. Space	D Face Frame Opening	E* Full Overlay At Min. At Max.		E Partial Overlay At Min. At Max.		F Actual Cabinet
WC24../STWC24..	24"	5"	29"	7 1/2"	1 3/4"	6 3/4"	2 1/2"	7 1/2"	24"
WC27../STWC27..	27"	4 1/2"	31 1/2"	9"	3 1/4"	7 3/4"	4"	8 1/2"	27"
WC30../STWC30..	30"	5"	35"	13 1/2"	1 3/4"	6 3/4"	2 1/2"	7 1/2"	30"
WC33../STWC33..	33"	4 1/2"	37 1/2"	15"	3 1/4"	7 3/4"	4"	8 1/2"	33"
WC36../STWC36..	36"	5"	41"	19 1/2"	1 3/4"	6 3/4"	2 1/2"	7 1/2"	36"
WC39../STWC39..	39"	4 1/2"	43 1/2"	21"	3 1/4"	7 3/4"	4"	8 1/2"	39"
WC42../STWC42..	42"	4 1/2"	46 1/2"	24"	3 1/4"	7 3/4"	4"	8 1/2"	42"
WC45../STWC45..	45"	4 1/2"	49 1/2"	27"	3 1/4"	7 3/4"	4"	8 1/2"	45"
WC48../STWC48..	48"	4 1/2"	52 1/2"	30"	3 1/4"	7 3/4"	4"	8 1/2"	48"

¹Minimum/maximum space between inside edge of door and face of filler/adjoining cabinet.
If cabinet is pulled to maximum stated dimension, filler will need to be cleated for proper attachment.

WALL CORNER SINGLE DOOR, 24" or 27" HIGH

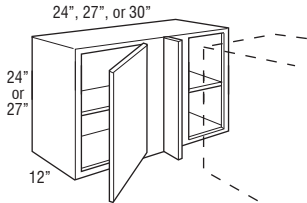

	Price Point												
		1	2	3	4	5	6	7	8	9	10	11	12
WC2424 L or R	494	547	566	584	601	619	654	683	710	736	756	820	
WC2724 L or R	524	592	613	633	653	673	713	741	772	799	820	886	
WC3024 L or R	554	640	661	682	703	725	769	801	833	862	886	961	
WC2427 L or R	532	586	607	627	647	668	706	737	764	794	814	883	
WC2727 L or R	564	638	661	683	706	728	772	801	832	864	887	959	
WC3027 L or R	598	690	713	736	759	782	830	864	899	931	956	1035	

- Includes one 3" filler, shipped unattached.
- L or R indicates void. R (right) void shown.

Custom Modifications

ADDTK	AUTH	CBO	CCO	CFNTO	CFRMO	CH	CND	CW	EXBK	EX	FB	FFD	FPEB	ID	INVFRM	MIP	P	PFINBTMB	RD	TD	TVR_V
•	•	•	•	•	•	• ¹	•	• ²	•	•	•	• ³	•	•	•	•	•	•	•	•	•

Construction Upgrades

APC	PE
•	•

Door Options

ALF	CG	CG.BTM	CG.TOP	DPSRR	MD	MD.BTM	MD.TOP	MFO
•	•	•	•	•	•	•	•	•

¹ Not available on 24" high

² Width reduction is taken from door section and does not affect corner void or clearance dimensions. Not available on 24" wide.

³ Face Frame and Door on End modification not available on the void side of the cabinet.

**WALL CORNER SINGLE DOOR,
30", 33", or 36" HIGH**

24", 27", 30", 33", or 36"

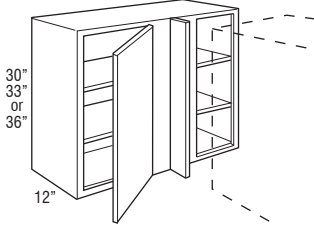

Price
Point

	1	2	3	4	5	6	7	8	9	10	11	12
WC2430 L or R	568	625	647	670	692	715	757	788	816	851	871	943
WC2730 L or R	605	683	708	732	757	782	829	860	893	927	954	1030
WC3030 L or R	641	740	766	791	815	840	888	926	965	999	1026	1109
WC3330 L or R	673	780	806	832	859	885	939	977	1018	1053	1081	1170
WC3630 L or R	706	814	843	871	899	927	986	1024	1064	1105	1137	1231
WC2433 L or R	643	704	729	754	778	802	851	885	920	955	978	1061
WC2733 L or R	679	767	794	821	848	875	926	964	998	1039	1067	1155
WC3033 L or R	719	830	858	886	914	941	999	1040	1082	1121	1150	1245
WC3333 L or R	756	872	903	932	962	991	1054	1095	1140	1183	1213	1314
WC3633 L or R	794	917	949	980	1011	1042	1107	1149	1195	1240	1275	1379
WC2436 L or R	720	783	810	836	861	887	943	979	1019	1058	1083	1173
WC2736 L or R	755	849	879	908	937	967	1026	1064	1108	1149	1180	1279
WC3036 L or R	795	918	950	981	1012	1044	1108	1152	1200	1241	1277	1380
WC3336 L or R	839	968	1001	1035	1068	1101	1169	1212	1262	1310	1343	1457
WC3636 L or R	883	1018	1053	1086	1121	1155	1228	1275	1326	1374	1411	1528

- Includes one 3" filler, shipped unattached.
- L or R indicates void. R (right) void shown.

Custom Modifications

ADDTK	AUTH	CBO	CCO	CFNTO	CFRMO	CH	CND	CW	EXBK	EX	FB	FFD	FPEB	ID	INFRM	MIP	P	PFINBTMB	RD	TD	TVR_V	
•	•	•	•	•	•	• ¹	• ²	•	•	•	• ³	•	•	•	•	•	•	•	•	•	•	•

Construction Upgrades

APC	PE
•	•

Door Options

ALF	CG	CG.BTM	CG.TOP	DPSRR	MD	MD.BTM	MD.TOP	MFO
•	•	•	•	•	• ⁴	•	•	•

¹ Not available on 30" high

² Width reduction is taken from door section and does not affect corner void or clearance dimensions. Not available on 24" wide.

³ Face Frame and Door on End modification not available on the void side of the cabinet.

⁴ Available only on 30", 33", and 36" wide

**WALL CORNER DOUBLE DOOR,
30", 33", or 36" HIGH**

39", 42", 45", or 48"

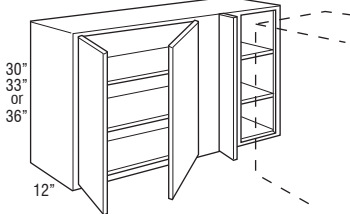

WC3930 L or R	846	967	991	1015	1038	1062	1122	1166	1213	1258	1291	1401
WC4230 L or R	889	1021	1062	1101	1141	1180	1250	1297	1351	1400	1438	1557
WC4530 L or R	920	1060	1100	1139	1179	1219	1290	1340	1393	1445	1483	1606
WC4830 L or R	949	1100	1138	1176	1214	1252	1329	1381	1435	1488	1528	1656
WC3933 L or R	914	1055	1091	1127	1163	1197	1272	1323	1375	1427	1466	1587
WC4233 L or R	960	1107	1145	1183	1221	1258	1336	1388	1443	1499	1540	1667
WC4533 L or R	1007	1163	1203	1242	1281	1320	1403	1457	1515	1574	1618	1749
WC4833 L or R	1057	1221	1262	1304	1345	1385	1474	1529	1592	1651	1698	1837
WC3936 L or R	1016	1169	1210	1249	1288	1327	1412	1465	1523	1580	1623	1756
WC4236 L or R	1066	1230	1271	1313	1354	1394	1483	1540	1602	1659	1704	1845
WC4536 L or R	1120	1290	1334	1378	1421	1464	1555	1615	1682	1743	1789	1938
WC4836 L or R	1175	1354	1400	1445	1491	1536	1634	1697	1766	1830	1878	2034

- Includes one 3" filler, shipped unattached.
- L or R indicates void. R (right) void shown.
- On 39" wide cabinets, Peninsula and Mullion Door options cannot be ordered together due to the unavailability of Mullion Doors for the double door side.

Custom Modifications

ADDTK	AUTH	CBO	CCO	CFNTO	CFRMO	CH	CND	CW	EXBK	EX	FB	FFD	FPEB	ID	INFRM	MIP	P	PFINBTMB	RD	TD	TVR_V	
•	•	•	•	•	•	• ¹	• ²	•	•	•	• ³	•	•	•	•	•	•	•	•	•	•	•

Construction Upgrades

APC	PE
•	•

Door Options

ALF	CG	CG.BTM	CG.TOP	DPSRR	MD	MD.BTM	MD.TOP	MFO
•	•	•	•	•	•	•	•	•

¹ Not available on 30" high

² Width reduction is taken from door section and does not affect corner void or clearance dimensions. Not available on 39" wide.

³ Face Frame and Door on End modification not available on the void side of the cabinet.

WALL CORNER SINGLE DOOR, 39" or 42" HIGH

24", 27", 30", 33", or 36"

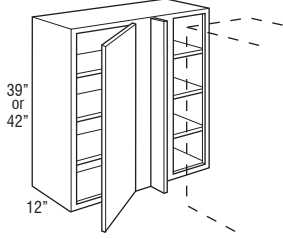

Price Point	1	2	3	4	5	6	7	8	9	10	11	12
WC2439 L or R	791	862	892	920	949	977	1039	1079	1119	1161	1192	1289
WC2739 L or R	831	935	968	999	1030	1062	1130	1170	1219	1264	1296	1407
WC3039 L or R	875	1009	1045	1080	1114	1149	1222	1268	1320	1366	1404	1521
WC3339 L or R	924	1062	1100	1137	1174	1211	1285	1334	1389	1440	1477	1600
WC3639 L or R	971	1117	1156	1194	1233	1271	1351	1402	1458	1512	1551	1681
WC2442 L or R	871	945	977	1007	1038	1068	1135	1177	1226	1272	1305	1412
WC2742 L or R	916	1021	1056	1091	1126	1160	1232	1280	1334	1382	1417	1536
WC3042 L or R	954	1096	1136	1174	1213	1251	1328	1379	1434	1487	1527	1655
WC3342 L or R	1009	1156	1197	1239	1280	1322	1401	1457	1514	1570	1611	1745
WC3642 L or R	1057	1213	1257	1299	1343	1385	1469	1528	1587	1646	1689	1833

- Includes one 3" filler, shipped unattached.
- L or R indicates void. R (right) void shown.

Custom Modifications

ADDTK	AUTH	CBO	CCO	CFNTO	CFRMO	CH	CND	CW	EXBK	EX	FB	FFD	FPEB	ID	INVFRM	MIP	P	PFINBTMB	RD	TD	TVR_V	
•	•	•	•	•	•	• ¹	•	• ²	•	•	•	• ³	•	•	•	•	•	•	•	•	•	•

Construction Upgrades

APC	PE
•	•

Door Options

ALF	CG	CG.BTM	CG.TOP	DPSRR	MD	MD.BTM	MD.TOP	MFO
•	•	•	•	•	• ⁴	•	•	•

¹ Not available on 39" high
² Width reduction is taken from door section and does not affect corner void or clearance dimensions. Not available on 24" wide.
³ Face Frame and Door on End modification not available on the void side of the cabinet.
⁴ Available only on 30", 33", and 36" wide

WALL CORNER DOUBLE DOOR, 39" or 42" HIGH

39", 42", 45", or 48"

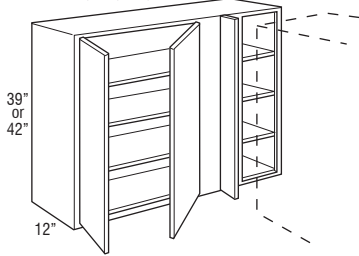

WC3939 L or R	1117	1284	1328	1373	1418	1462	1553	1612	1677	1738	1783	1934
WC4239 L or R	1172	1347	1394	1441	1488	1534	1632	1692	1761	1826	1874	2031
WC4539 L or R	1231	1416	1465	1513	1562	1611	1712	1776	1849	1917	1967	2132
WC4839 L or R	1292	1486	1538	1589	1641	1691	1799	1866	1942	2013	2064	2239
WC3942 L or R	1216	1397	1446	1495	1544	1594	1690	1756	1824	1894	1942	2107
WC4242 L or R	1278	1466	1519	1570	1623	1674	1775	1845	1916	1989	2040	2212
WC4542 L or R	1341	1541	1596	1650	1704	1757	1864	1938	2012	2088	2143	2323
WC4842 L or R	1408	1616	1674	1732	1789	1846	1957	2034	2112	2193	2249	2438

- Includes one 3" filler, shipped unattached.
- L or R indicates void. R (right) void shown.
- On 39" wide cabinets, Peninsula and Mullion Door options cannot be ordered together due to the unavailability of Mullion Doors for the double door side.

Custom Modifications

ADDTK	AUTH	CBO	CCO	CFNTO	CFRMO	CH	CND	CW	EXBK	EX	FB	FFD	FPEB	ID	INVFRM	MIP	P	PFINBTMB	RD	TD	TVR_V	
•	•	•	•	•	•	• ¹	•	• ²	•	•	•	• ³	•	•	•	•	•	•	•	•	•	•

Construction Upgrades

APC	PE
•	•

Door Options

ALF	CG	CG.BTM	CG.TOP	DPSRR	MD	MD.BTM	MD.TOP	MFO
•	•	•	•	•	•	•	•	•

¹ Not available on 39" high
² Width reduction is taken from door section and does not affect corner void or clearance dimensions. Not available on 39" wide.
³ Face Frame and Door on End modification not available on the void side of the cabinet.

STACKED WALL CORNER SINGLE DOOR, 48", 51", 54", 57", or 60" HIGH

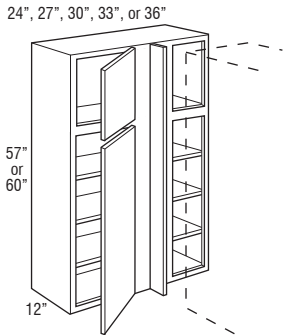
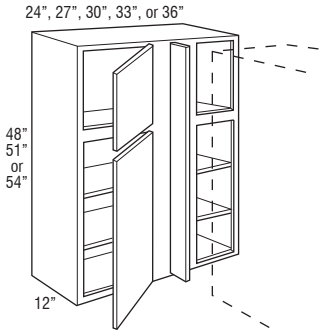

Price Point	1	2	3	4	5	6	7	8	9	10	11	12
STWC2448 L or R	1243	1398	1440	1483	1525	1568	1648	1707	1761	1813	1857	1999
STWC2748 L or R	1303	1466	1514	1561	1608	1655	1739	1799	1860	1914	1961	2113
STWC3048 L or R	1378	1552	1602	1650	1698	1746	1835	1898	1964	2019	2070	2230
STWC3348 L or R	1436	1620	1671	1723	1774	1826	1921	1988	2055	2118	2167	2337
STWC3648 L or R	1504	1706	1760	1812	1865	1917	2020	2089	2160	2228	2276	2455
STWC2451 L or R	1312	1480	1524	1568	1612	1655	1738	1802	1860	1916	1963	2115
STWC2751 L or R	1376	1550	1600	1650	1699	1748	1838	1902	1969	2027	2076	2238
STWC3051 L or R	1455	1642	1693	1745	1796	1848	1947	2012	2082	2141	2195	2365
STWC3351 L or R	1515	1712	1767	1822	1877	1932	2034	2107	2181	2247	2297	2479
STWC3651 L or R	1590	1804	1861	1919	1976	2032	2140	2214	2295	2363	2418	2607
STWC2454 L or R	1380	1560	1605	1650	1695	1739	1832	1900	1960	2018	2068	2230
STWC2754 L or R	1452	1637	1688	1738	1789	1839	1939	2007	2076	2138	2191	2360
STWC3054 L or R	1531	1733	1788	1842	1897	1951	2055	2126	2199	2265	2321	2501
STWC3354 L or R	1593	1807	1865	1923	1981	2038	2149	2227	2304	2373	2428	2620
STWC3654 L or R	1676	1902	1963	2025	2087	2148	2262	2341	2426	2498	2557	2760

STWC2457 L or R	1448	1639	1688	1736	1784	1832	1925	1998	2061	2127	2178	2348
STWC2757 L or R	1523	1723	1776	1830	1884	1938	2042	2112	2188	2256	2308	2489
STWC3057 L or R	1611	1821	1880	1939	1998	2056	2165	2239	2317	2390	2448	2641
STWC3357 L or R	1674	1900	1962	2025	2088	2149	2265	2344	2427	2501	2560	2764
STWC3657 L or R	1765	2001	2068	2132	2199	2264	2386	2470	2559	2636	2699	2912
STWC2460 L or R	1515	1714	1766	1818	1869	1921	2019	2093	2163	2231	2286	2464
STWC2760 L or R	1595	1803	1863	1921	1979	2037	2144	2223	2302	2371	2430	2622
STWC3060 L or R	1682	1911	1973	2036	2099	2162	2275	2358	2437	2516	2574	2778
STWC3360 L or R	1756	1989	2057	2126	2194	2261	2383	2468	2556	2635	2700	2914
STWC3660 L or R	1854	2096	2168	2240	2313	2384	2512	2601	2695	2776	2843	3070

- Includes one 3" filler, shipped unattached.
- L or R indicates void. R (right) void shown.

Custom Modifications

ADDTK	AUTH	CBO	CCO	CFNTO	CFRMO	CH	CND	CW	EXBK	EX	FB	FFD	FPEB	ID	INFRM	MIP	P	PFINBTMB	RD	TD	TVR_V	
•	•	•	•	•	•	• ¹	•	• ²	•	•	•	• ³	•	•	•	•	•	•	•	•	•	•

Construction Upgrades

APC	PE
•	•

Door Options

ALF	CG	CG.BTM	CG.TOP	DPSRR	MD	MD.BTM	MD.TOP	MFO
•	•	•	•	•	• ⁴	• ⁴	•	•

¹ Not available on 48" high

² Width reduction is taken from door section and does not affect corner void or clearance dimensions. Not available on 24" wide.

³ Face Frame and Door on End modification not available on the void side of the cabinet.

⁴ Available only on 30", 33", and 36" wide

**STACKED WALL CORNER
DOUBLE DOOR, 48", 51",
54", 57", or 60" HIGH**

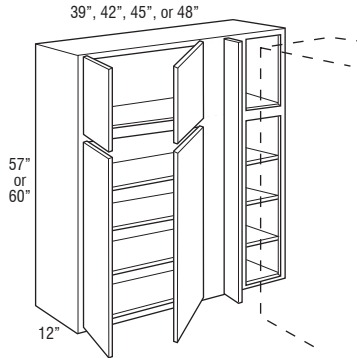
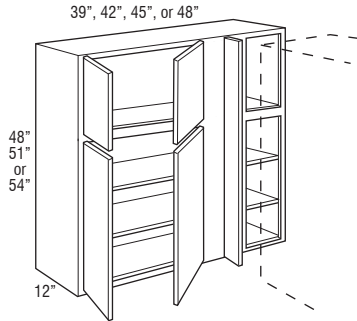

Price Point	1	2	3	4	5	6	7	8	9	10	11	12
STWC3948 L or R	1679	1898	1961	2024	2087	2148	2260	2335	2417	2495	2549	2746
STWC4248 L or R	1814	2054	2121	2187	2255	2321	2443	2530	2620	2697	2762	2978
STWC4548 L or R	1858	2108	2176	2244	2313	2380	2507	2595	2689	2770	2839	3061
STWC4848 L or R	2171	2471	2549	2626	2705	2782	2931	3037	3146	3246	3326	3592
STWC3951 L or R	1789	2025	2091	2157	2223	2289	2410	2491	2582	2663	2723	2936
STWC4251 L or R	1912	2166	2237	2307	2378	2448	2577	2671	2768	2852	2919	3149
STWC4551 L or R	1963	2228	2300	2372	2445	2517	2652	2750	2848	2937	3007	3244
STWC4851 L or R	2302	2617	2704	2789	2875	2960	3123	3235	3352	3460	3545	3829
STWC3954 L or R	1896	2148	2219	2289	2360	2430	2559	2647	2743	2831	2895	3121
STWC4254 L or R	2007	2279	2353	2427	2501	2575	2712	2810	2911	3005	3076	3322
STWC4554 L or R	2064	2345	2424	2501	2578	2656	2797	2900	3005	3099	3175	3427
STWC4854 L or R	2427	2766	2860	2953	3046	3139	3311	3433	3559	3675	3764	4066

STWC3957 L or R	1997	2264	2339	2414	2489	2563	2698	2792	2896	2990	3059	3298
STWC4257 L or R	2113	2401	2481	2559	2638	2716	2860	2967	3072	3170	3245	3504
STWC4557 L or R	2175	2474	2556	2638	2719	2800	2953	3061	3173	3274	3352	3621
STWC4857 L or R	2561	2923	3023	3121	3220	3319	3499	3629	3765	3888	3983	4302
STWC3960 L or R	2091	2372	2454	2535	2616	2697	2846	2943	3051	3155	3224	3478
STWC4260 L or R	2216	2516	2602	2688	2774	2860	3016	3123	3236	3341	3420	3694
STWC4560 L or R	2284	2593	2684	2773	2864	2953	3114	3224	3343	3453	3536	3818
STWC4860 L or R	2697	3069	3177	3285	3394	3501	3696	3833	3973	4107	4207	4544

- Includes one 3" filler, shipped unattached.
- L or R indicates void. R (right) void shown.

Custom Modifications

ADDTK	AUTH	CBO	CCO	CFNTO	CFRMO	CH	CND	CW	EXBK	EX	FB	FFD	FPEB	ID	INVERM	MIP	P	PFINBTMB	RD	TD	TVR_V
•	•	•	•	•	•	• ¹		• ²	•	•	•	• ³	•	•	•	•		•	•		

Construction Upgrades

APC	PE
•	•

Door Options

ALF	CG	CG.BTM	CG.TOP	DPSRR	MD	MD.BTM	MD.TOP	MFO
		•	•	•		• ⁴	• ⁴	•

¹ Not available on 48" high

² Width reduction is taken from door section and does not affect corner void or clearance dimensions. Not available on 39" wide.

³ Face Frame and Door on End modification not available on the void side of the cabinet.

⁴ Not available on 39" wide

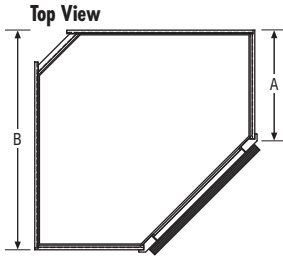

Diagonal Wall Cabinets with Increased or Reduced Depth

	RD9	RD10	RD11	STD	ID13	ID14	ID15	ID16	ID17	ID18	ID19	ID20	ID21	ID22	ID23	ID24	
Cabinet Depth	A	9"	10"	11"	12"	13"	14"	15"	16"	17"	18"	19"	20"	21"	22"	23"	24"
Wall Space	B	21"	22"	23"	24"	25"	26"	27"	28"	29"	30"	31"	32"	33"	34"	35"	36"

DIAGONAL WALL, 12", 15", or 18" HIGH, 24" x 24"

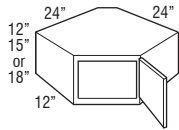

	Price Point	1	2	3	4	5	6	7	8	9	10	11	12
DW122424 L or R		360	416	431	447	463	477	507	525	548	564	582	631
DW152424 L or R		399	464	480	496	513	529	562	582	609	628	647	701
DW182424 L or R		442	515	533	551	569	587	623	650	675	698	718	778

- Requires 24" x 24" of corner wall space.
- Full overlay styles use the same width doors as partial overlay styles (14 1/2" wide) with a partial overlay hinge (38NPOHINGE) to allow for proper door clearance with adjacent cabinets.

Custom Modifications

ADDTK	AUTH	CBO	CCO	CFNTO	CFRMO	CH	CND	CW	EXBK	EX	FB	FFD	FPEB	ID	INFRM	MIP	P	PFINBTMB	RD	TD	TVR_V	
	•		•	•	•	• ¹					• ²	•	•			•		•		•		

Construction Upgrades

APC	PE
•	•

Door Options

ALF	CG	CG.BTM	CG.TOP	DPSRR	MD	MD.BTM	MD.TOP	MFO
	•			•	• ¹			•

¹ Not available on 12" high
² Available only on 18" high

DIAGONAL WALL, 24" or 27" HIGH, 24" x 24"

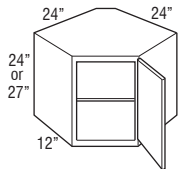

DW242424 L or R	493	571	592	613	633	653	694	721	750	776	799	865
DW272424 L or R	547	636	659	681	703	726	772	801	834	862	886	961

- Requires 24" x 24" of corner wall space.
- Adjustable shelf cannot be removed/retrofitted.
- Full overlay styles use the same width doors as partial overlay styles (14 1/2" wide) with a partial overlay hinge (38NPOHINGE) to allow for proper door clearance with adjacent cabinets.

Custom Modifications

ADDTK	AUTH	CBO	CCO	CFNTO	CFRMO	CH	CND	CW	EXBK	EX	FB	FFD	FPEB	ID	INFRM	MIP	P	PFINBTMB	RD	TD	TVR_V	
	•	•	•	•	•	•					•	•	•	•		•		•		•		

Construction Upgrades

APC	PE
•	•

Door Options

ALF	CG	CG.BTM	CG.TOP	DPSRR	MD	MD.BTM	MD.TOP	MFO
	•			•	• ¹			•

¹ Not available on 27" high

DIAGONAL WALL, 30", 33", 36", 39", or 42" HIGH, 24" x 24"

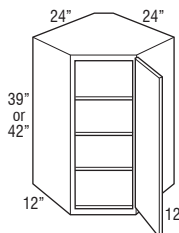
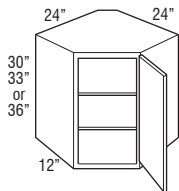

DW302424 L or R	607	706	731	756	781	805	856	889	926	959	984	1068
DW332424 L or R	676	792	822	851	880	909	965	1001	1043	1080	1109	1202
DW362424 L or R	746	879	913	945	979	1011	1072	1116	1158	1201	1234	1336

DW392424 L or R	821	969	1005	1040	1076	1112	1180	1229	1276	1322	1359	1468
DW422424 L or R	906	1052	1093	1133	1175	1215	1289	1340	1394	1446	1482	1605

- Requires 24" x 24" of corner wall space.
- Adjustable shelves.
- Full overlay styles use the same width doors as partial overlay styles (14 1/2" wide) with a partial overlay hinge (38NPOHINGE) to allow for proper door clearance with adjacent cabinets.

Custom Modifications

ADDTK	AUTH	CBO	CCO	CFNTO	CFRMO	CH	CND	CW	EXBK	EX	FB	FFD	FPEB	ID	INFRM	MIP	P	PFINBTMB	RD	TD	TVR_V	
	•	•	•	•	•	•					•	•	•	•		•		•		•		

Construction Upgrades

APC	PE
•	•

Door Options

ALF	CG	CG.BTM	CG.TOP	DPSRR	MD	MD.BTM	MD.TOP	MFO
	•			•	•			•

DIAGONAL WALL, 12", 15", or 18" HIGH, 27" x 27"

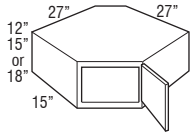

Price Point	1	2	3	4	5	6	7	8	9	10	11	12
DW122727 L or R	580	657	719	780	840	900	956	999	1044	1109	1169	1267
DW152727 L or R	643	729	797	865	933	1000	1062	1110	1160	1232	1298	1407
DW182727 L or R	717	810	886	961	1036	1111	1178	1231	1286	1369	1444	1562

- Requires 27" x 27" of corner wall space.
- Full overlay styles use the same width doors as partial overlay styles (14 1/2" wide) with a partial overlay hinge (38NPOHINGE) to allow for proper door clearance with adjacent cabinets.

Custom Modifications

ADDTK	AUTH	CBO	CCO	CFNTO	CFRMO	CH	CND	CW	EXBK	EX	FB	FFD	FPEB	ID	INVFRM	MIP	P	PFINBTMB	RD	TD	TVR_V	
	•		•	•		•	• ¹				•	• ²	•	•		•		•	•			

Construction Upgrades

APC	PE
•	•

Door Options

ALF	CG	CG.BTM	CG.TOP	DPSRR	MD	MD.BTM	MD.TOP	MFO
	•			•	• ¹			•

¹ Not available on 12" high

² Available only on 18" high

DIAGONAL WALL, 24" or 27" HIGH, 27" x 27"

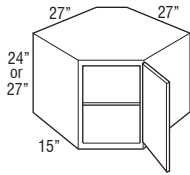

DW242727 L or R	795	899	983	1066	1150	1233	1312	1371	1432	1522	1603	1736
DW272727 L or R	885	998	1092	1185	1279	1372	1455	1520	1588	1690	1781	1929

- Requires 27" x 27" of corner wall space.
- Adjustable shelf cannot be removed/retrofitted.
- Full overlay styles use the same width doors as partial overlay styles (14 1/2" wide) with a partial overlay hinge (38NPOHINGE) to allow for proper door clearance with adjacent cabinets.

Custom Modifications

ADDTK	AUTH	CBO	CCO	CFNTO	CFRMO	CH	CND	CW	EXBK	EX	FB	FFD	FPEB	ID	INVFRM	MIP	P	PFINBTMB	RD	TD	TVR_V	
	•	•	•	•		•	•				•	•	•	•		•		•	•			

Construction Upgrades

APC	PE
•	•

Door Options

ALF	CG	CG.BTM	CG.TOP	DPSRR	MD	MD.BTM	MD.TOP	MFO
	•			•	• ¹			•

¹ Not available on 27" high

DIAGONAL WALL, 30", 33", 36", 39", or 42" HIGH, 27" x 27"

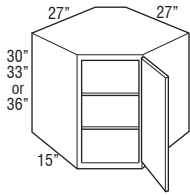

DW302727 L or R	982	1110	1214	1317	1421	1524	1620	1692	1768	1878	1980	2143
DW332727 L or R	1049	1187	1298	1408	1518	1627	1727	1804	1885	2007	2113	2289
DW362727 L or R	1116	1262	1379	1495	1612	1728	1837	1920	2006	2132	2246	2433

- Requires 27" x 27" of corner wall space.
- Full overlay styles use the same width doors as partial overlay styles (14 1/2" wide) with a partial overlay hinge (38NPOHINGE) to allow for proper door clearance with adjacent cabinets.

Custom Modifications

ADDTK	AUTH	CBO	CCO	CFNTO	CFRMO	CH	CND	CW	EXBK	EX	FB	FFD	FPEB	ID	INVFRM	MIP	P	PFINBTMB	RD	TD	TVR_V	
	•	•	•	•		•	•				•	•	•	•		•		•	•			

Construction Upgrades

APC	PE
•	•

Door Options

ALF	CG	CG.BTM	CG.TOP	DPSRR	MD	MD.BTM	MD.TOP	MFO
	•			•	•			•

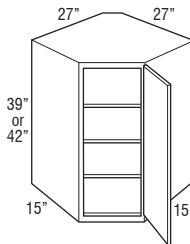

DIAGONAL WALL with LAZY SUSAN, 30", 33", 36", 39", or 42" HIGH, 24" x 24"

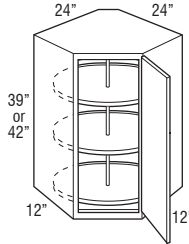
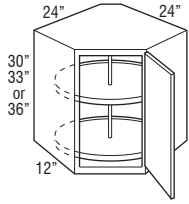

Price Point	1	2	3	4	5	6	7	8	9	10	11	12
DW302424S L or R	869	991	1033	1073	1114	1155	1225	1273	1324	1373	1410	1529
DW332424S L or R	961	1109	1155	1200	1244	1289	1369	1422	1478	1533	1572	1706
DW362424S L or R	1049	1226	1277	1326	1375	1425	1511	1568	1632	1692	1736	1880
DW392424S L or R	1154	1347	1403	1458	1513	1568	1660	1726	1794	1864	1906	2069
DW422424S L or R	1230	1459	1520	1579	1639	1698	1801	1868	1945	2015	2070	2244

- Requires 24" x 24" of corner wall space.
- Plywood shelves are 18" in overall diameter with a 17" interior diameter and 1" high lip.
- Shelves rotate independently.
- Full overlay styles use the same width doors as partial overlay styles (14 1/2" wide) with a partial overlay hinge (38NPOHINGE) to allow for proper door clearance with adjacent cabinets.

Custom Modifications

ADDTK	AUTH	CBO	CCO	CFNTO	CFRMO	CH	CND	CW	EXBK	EX	FB	FFD	FPEB	ID	INVFRM	MIP	P	PFINBTMB	RD	TD	TVR_V	
	•	•	•	•	•						•	•	•			•		•				

Construction Upgrades

APC	PE
•	•

Door Options

ALF	CG	CG.BTM	CG.TOP	DPSRR	MD	MD.BTM	MD.TOP	MFO
	•			•	•			•

DIAGONAL WALL with LOWER DOOR, 48", 51", 54", 57", or 60" HIGH, 24" x 24"

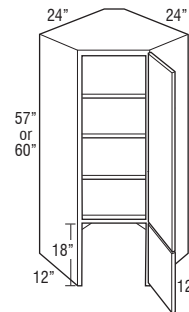
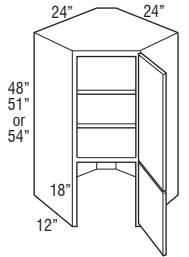

DW302424D L or R	1119	1253	1297	1340	1383	1426	1514	1572	1636	1692	1738	1886
DW332424D L or R	1187	1340	1385	1431	1477	1522	1616	1677	1744	1808	1855	2010
DW362424D L or R	1250	1425	1474	1522	1570	1618	1714	1782	1855	1922	1973	2136
DW392424D L or R	1378	1566	1620	1672	1726	1779	1887	1960	2038	2113	2169	2350
DW422424D L or R	1382	1588	1644	1700	1756	1812	1925	2000	2078	2153	2211	2396

- Requires 24" x 24" of corner wall space.
- Lower section of cabinet does not have a bottom (floor).
- Mullion Doors not available on bottom door.
- Full overlay styles use the same width doors as partial overlay styles (14 1/2" wide) with a partial overlay hinge (38NPOHINGE) to allow for proper door clearance with adjacent cabinets.

Custom Modifications

ADDTK	AUTH	CBO	CCO	CFNTO	CFRMO	CH	CND	CW	EXBK	EX	FB	FFD	FPEB	ID	INVFRM	MIP	P	PFINBTMB	RD	TD	TVR_V	
	•	•	•	•	•	• ¹					•		•	•		•			•			

Construction Upgrades

APC	PE
•	•

Door Options

ALF	CG	CG.BTM	CG.TOP	DPSRR	MD	MD.BTM	MD.TOP	MFO
		•	•	•			•	•

¹ Not available on 48" high

DIAGONAL WALL with LOWER DOOR, 48", 51", 54", 57", or 60" HIGH, 27" x 27"

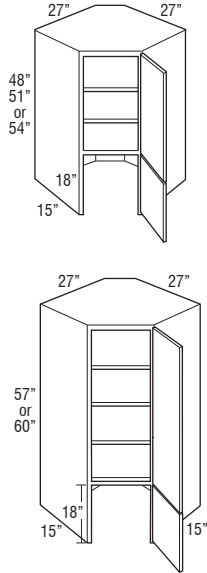

Price Point	1	2	3	4	5	6	7	8	9	10	11	12
DW302727D L or R	1587	1716	1829	1941	2054	2166	2299	2388	2466	2544	2614	2834
DW332727D L or R	1652	1792	1912	2032	2152	2270	2410	2503	2587	2670	2750	2978
DW362727D L or R	1720	1865	1992	2120	2248	2376	2518	2619	2708	2798	2883	3124
DW392727D L or R	1894	2052	2192	2332	2472	2611	2773	2880	2979	3078	3173	3435
DW422727D L or R	1866	2053	2188	2324	2460	2595	2751	2860	2974	3086	3204	3470

- Requires 27" x 27" of corner wall space.
- Lower section of cabinet does not have a bottom (floor).
- Mullion Doors not available on bottom door.
- Full overlay styles use the same width doors as partial overlay styles (14 1/2" wide) with a partial overlay hinge (38NPOHINGE) to allow for proper door clearance with adjacent cabinets.

Custom Modifications

ADDTK	AUTH	CBO	CCO	CFNTO	CFRMO	CH	CND	CW	EXBK	EX	FB	FFD	FPEB	ID	INVFRM	MIP	P	PFINBTMB	RD	TD	TVR_V	
	•	•	•	•	•	• ¹					•		•	•		•				•		

Construction Upgrades

APC	PE
•	

Door Options

ALF	CG	CG.BTM	CG.TOP	DPSRR	MD	MD.BTM	MD.TOP	MFO
		•	•	•			•	•

¹ Not available on 48" high

STACKED DIAGONAL WALL, 48", 51", 54", 57", or 60" HIGH, 24" x 24"

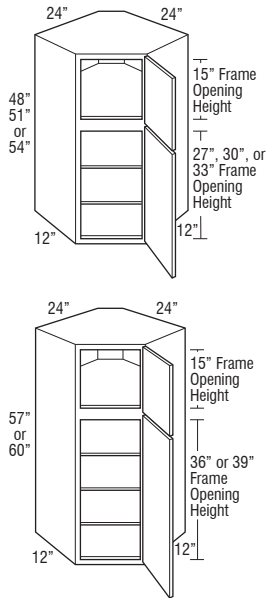

STDW482424 L or R	1947	2045	2068	2089	2111	2132	2183	2229	2265	2285	2312	2447
STDW512424 L or R	2016	2132	2158	2184	2210	2236	2290	2343	2383	2407	2436	2580
STDW542424 L or R	2084	2219	2248	2277	2306	2335	2396	2454	2499	2528	2560	2716

STDW572424 L or R	2160	2307	2340	2372	2405	2437	2505	2568	2616	2647	2684	2850
STDW602424 L or R	2221	2391	2429	2466	2504	2541	2614	2679	2732	2772	2809	2986

- Requires 24" x 24" of corner wall space.
- Full overlay styles use the same width doors as partial overlay styles (14 1/2" wide) with a partial overlay hinge (38NPOHINGE) to allow for proper door clearance with adjacent cabinets.

Custom Modifications

ADDTK	AUTH	CBO	CCO	CFNTO	CFRMO	CH	CND	CW	EXBK	EX	FB	FFD	FPEB	ID	INVFRM	MIP	P	PFINBTMB	RD	TD	TVR_V	
	•	•	•	•	•	• ¹					•		•	•		•				•		

Construction Upgrades

APC	PE
•	•

Door Options

ALF	CG	CG.BTM	CG.TOP	DPSRR	MD	MD.BTM	MD.TOP	MFO
		•	•	•		•	•	•

¹ Not available on 48" high

**STACKED DIAGONAL WALL,
48", 51", 54", 57", or 60" HIGH,
27" x 27"**

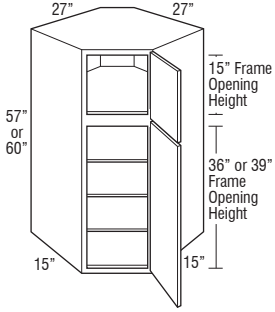
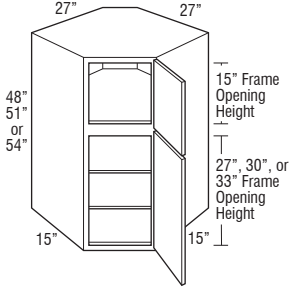

Price Point	1	2	3	4	5	6	7	8	9	10	11	12
STDW482727 L or R	2588	2718	2818	2916	3015	3114	3208	3287	3378	3468	3571	3795
STDW512727 L or R	2656	2791	2897	3004	3110	3217	3315	3399	3497	3593	3703	3940
STDW542727 L or R	2722	2867	2980	3093	3207	3319	3426	3512	3618	3722	3836	4086

STDW572727 L or R	2834	2995	3119	3242	3367	3490	3610	3703	3820	3937	4061	4330
STDW602727 L or R	2868	3055	3176	3297	3418	3538	3660	3755	3883	4011	4153	4432

- Requires 27" x 27" of corner wall space.
- Full overlay styles use the same width doors as partial overlay styles (14 1/2" wide) with a partial overlay hinge (38NPOHINGE) to allow for proper door clearance with adjacent cabinets.

Custom Modifications

ADDTK	AUTH	CBO	CCO	CFNTD	CFRMO	CH	CND	CW	EXBK	EX	FB	FFD	FPEB	ID	INVFRM	MIP	P	PFINBTMB	RD	TD	TVR_V	
	•	•	•	•	•	• ¹					•		•	•	•	•		•	•			

Construction Upgrades

APC	PE
•	•

Door Options

ALF	CG	CG.BTM	CG.TOP	DPSRR	MD	MD.BTM	MD.TOP	MFO
		•	•	•		•	•	•

¹ Not available on 48" high

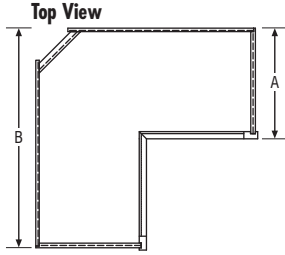

Easy Reach Wall Corner Cabinets with Increased or Reduced Depth

	RD9	RD10	RD11	STD	ID13	ID14	ID15	ID16	ID17	ID18	ID19	ID20	ID21	ID22	ID23	ID24	
Cabinet Depth (ER_2424)	A	9"	10"	11"	12"	13"	14"	15"	16"	17"	18"	19"	20"	21"	22"	23"	24"
Wall Space (ER_2424)	B	21"	22"	23"	24"	25"	26"	27"	28"	29"	30"	31"	32"	33"	34"	35"	36"
Cabinet Depth (ER_2121)	A	9"	10"	11"	12"	13"	14"	15"	16"	17"	18"	19"	20"	21"	22"	23"	24"
Wall Space (ER_2121)	B	18"	19"	20"	21"	22"	23"	24"	25"	26"	27"	28"	29"	30"	31"	32"	33"

EASY REACH WALL CORNER, 30", 33", 36", 39", or 42" HIGH, 21" x 21"

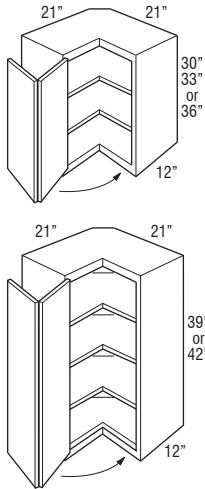

	Price Point	1	2	3	4	5	6	7	8	9	10	11	12
ER302121 L or R		865	982	1020	1058	1096	1133	1200	1250	1299	1344	1383	1500
ER332121 L or R		961	1091	1133	1176	1219	1260	1335	1389	1441	1496	1534	1662
ER362121 L or R		1053	1200	1247	1292	1338	1384	1467	1527	1587	1644	1687	1828
ER392121 L or R		1157	1320	1372	1422	1473	1523	1616	1678	1745	1809	1855	2009
ER422121 L or R		1157	1320	1372	1422	1473	1523	1616	1678	1745	1809	1855	2009

- Requires 21" x 21" of corner wall space.
- Decorative hardware screws must be countersunk to prevent scratching of adjacent cabinets and face frame of ER.
- Adjustable shelves.
- Hinged door opens 170°.
- Integrated soft-close hinge not included.

Custom Modifications

ADDTK	AUTH	CBO	CCO	CFNTO	CFRMO	CH	CND	CW	EXBK	EX	FB	FFD	FPEB	ID	INVERM	MIP	P	PFINBTMB	RD	TD	TVR_V	
	•	•	•			• ¹					•		•	•		•		•	•			

Construction Upgrades

APC	PE
•	•

Door Options

ALF	CG	CG.BTM	CG.TOP	DPSRR	MD	MD.BTM	MD.TOP	MFO
				•				•

¹ Not available on 30" high

EASY REACH WALL CORNER, 30", 33", 36", 39", or 42" HIGH, 24" x 24"

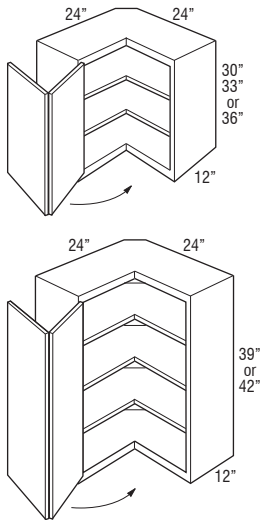

ER30 L or R	865	982	1020	1058	1096	1133	1200	1250	1299	1344	1383	1500
ER33 L or R	961	1091	1133	1176	1219	1260	1335	1389	1441	1496	1534	1662
ER36 L or R	1053	1200	1247	1292	1338	1384	1467	1527	1587	1644	1687	1828
ER39 L or R	1157	1320	1372	1422	1473	1523	1616	1678	1745	1809	1855	2009
ER42 L or R	1241	1411	1467	1523	1579	1634	1733	1803	1877	1941	1996	2164

- Requires 24" x 24" of corner wall space.
- Decorative hardware screws must be countersunk to prevent scratching of adjacent cabinets and face frame of ER.
- Adjustable shelves.
- Hinged door opens 170°.
- Integrated soft-close hinge not included.

Custom Modifications

ADDTK	AUTH	CBO	CCO	CFNTO	CFRMO	CH	CND	CW	EXBK	EX	FB	FFD	FPEB	ID	INVERM	MIP	P	PFINBTMB	RD	TD	TVR_V	
	•	•	•			• ¹					•		•	•		•		•	•			

Construction Upgrades

APC	PE
•	•

Door Options

ALF	CG	CG.BTM	CG.TOP	DPSRR	MD	MD.BTM	MD.TOP	MFO
				•				•

¹ Not available on 30" high

ASYMMETRICAL EASY REACH WALL CORNER, 30", 33", 36", 39", or 42" HIGH

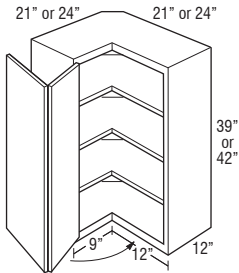
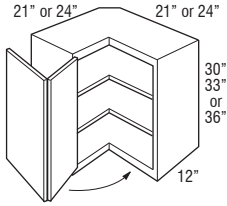

	Price Point	1	2	3	4	5	6	7	8	9	10	11	12
ER302124 L or R	865	982	1020	1058	1096	1133	1200	1250	1299	1344	1383	1500	
ER302421 L or R	865	982	1020	1058	1096	1133	1200	1250	1299	1344	1383	1500	
ER332124 L or R	961	1091	1133	1176	1219	1260	1335	1389	1441	1496	1534	1662	
ER332421 L or R	961	1091	1133	1176	1219	1260	1335	1389	1441	1496	1534	1662	
ER362124 L or R	1053	1200	1247	1292	1338	1384	1467	1527	1587	1644	1687	1828	
ER362421 L or R	1053	1200	1247	1292	1338	1384	1467	1527	1587	1644	1687	1828	

ER392124 L or R	1157	1320	1372	1422	1473	1523	1616	1678	1745	1809	1855	2009
ER392421 L or R	1157	1320	1372	1422	1473	1523	1616	1678	1745	1809	1855	2009
ER422124 L or R	1241	1411	1467	1523	1579	1634	1733	1803	1877	1941	1996	2164
ER422421 L or R	1241	1411	1467	1523	1579	1634	1733	1803	1877	1941	1996	2164

- Hinged door opens to 170°.
- Adjustable shelves.
- Legs at the front frames are 9" on 21" leg and 12" on 24" leg.
- Nomenclature for asymmetrical cabinets reads as follows:
 First set of numbers = height
 Second set of numbers = left side
 Third set of numbers = right side
- Decorative hardware screws must be countersunk to prevent scratching of adjacent cabinets and face frame of ER.
- ER__2124L shown.
- Integrated soft-close hinge not included.

Custom Modifications

ADDTK	AUTH	CBO	CCO	CFNTO	CFRMO	CH	CND	CW	EXBK	EX	FB	FFD	FPEB	ID	INVFRM	MIP	P	PFINBTMB	RD	TD	TVR_V	
	•	•	•			• ¹					•		•	•		•		•				

Construction Upgrades

APC	PE
•	•

Door Options

ALF	CG	CG.BTM	CG.TOP	DPSRR	MD	MD.BTM	MD.TOP	MFO
				•				•

¹ Not available on 30" high

WALL END CABINET SINGLE DOOR, 30", 33", 36", 39", or 42" HIGH, 12" x 12"

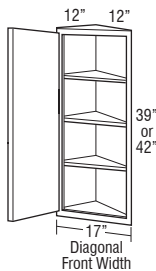
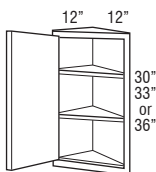

WEC1230 L or R	480	559	580	600	622	642	679	704	735	759	781	846
WEC1233 L or R	549	626	650	672	696	718	764	791	827	853	877	952
WEC1236 L or R	591	697	722	747	773	797	847	879	917	945	973	1053

WEC1239 L or R*	652	766	794	821	849	876	928	969	1007	1042	1071	1158
WEC1242 L or R*	688	791	832	874	915	955	1010	1051	1091	1132	1159	1257

- Width at wall: 12" x 12".
 - Cabinet features two unfinished back panels. Must be installed with one back panel adjacent to a cabinet of equal height with the other back panel attached to the wall.
- *When ordered with MD, shelves will not align with mullions.

Custom Modifications

ADDTK	AUTH	CBO	CCO	CFNTO	CFRMO	CH	CND	CW	EXBK	EX	FB	FFD	FPEB	ID	INVFRM	MIP	P	PFINBTMB	RD	TD	TVR_V	
		•	•	•	•	• ¹										•		•				

Construction Upgrades

APC	PE
•	

Door Options

ALF	CG	CG.BTM	CG.TOP	DPSRR	MD	MD.BTM	MD.TOP	MFO
	•			•	•			•

¹ Not available on 30" high

WALL END CABINET DOUBLE DOOR, 30", 33", 36", 39", or 42" HIGH, 12" x 12"

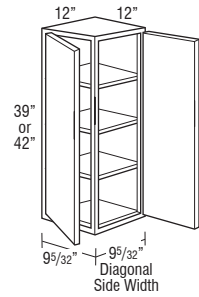
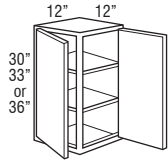
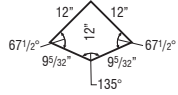

Price Point	1	2	3	4	5	6	7	8	9	10	11	12
WEC1230D	753	790	821	852	884	914	967	1007	1047	1083	1114	1205
WEC1233D	811	857	890	923	956	989	1048	1092	1137	1177	1210	1310
WEC1236D	870	922	959	996	1033	1068	1135	1177	1226	1272	1305	1412
WEC1239D	955	1015	1055	1095	1136	1175	1249	1295	1348	1399	1435	1553
WEC1242D	983	1053	1098	1141	1185	1229	1305	1355	1411	1463	1501	1626

- Width at wall: 12" x 12".
- Cabinet features two unfinished back panels. Must be installed with one back panel adjacent to a cabinet of equal height with the other back panel attached to the wall.
- Decorative glass inserts are not available.

Custom Modifications

ADTK	AUTH	CBO	CCO	CFNTO	CFRMO	CH	CND	CW	EXBK	EX	FB	FFD	FPEB	ID	INVERM	MIP	P	PFINBTMB	RD	TD	TVR_V	
		•	•			• ¹										•		•				

Construction Upgrades

APC	PE
•	

Door Options

ALF	CG	CG.BTM	CG.TOP	DPSRR	MD	MD.BTM	MD.TOP	MFO
	•			•				•

¹ Not available on 30" high

WALL QUARTER ROUND END SHELF, 30", 33", 36", 39", or 42" HIGH

Radius Top and Bottom Panels

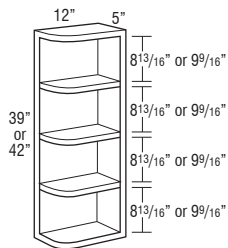
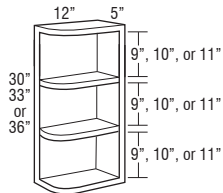
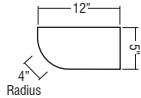

WQRES630RT	483	483	483	483	483	483	483	483	483	483	483	483
WQRES633RT	510	510	510	510	510	510	510	510	510	510	510	510
WQRES636RT	535	535	535	535	535	535	535	535	535	535	535	535
WQRES639RT	589	589	589	589	589	589	589	589	589	589	589	589
WQRES642RT	589	589	589	589	589	589	589	589	589	589	589	589

- Units are reversible.
- Radius moulding is not available for WQRES636RT.
- Veneer on 3/4" furniture board core with matching interior.
- If ordered with Heirloom Technique, will not feature sand-through characteristics.
- Cabinet features two unfinished back panels. Must be installed with one back panel adjacent to a cabinet of equal height with the other back panel attached to the wall.

MODIFICATIONS

No modifications available for these products.

Construction Upgrades

APC	PE
•	

**WALL QUARTER ROUND END SHELF,
30", 33", 36", 39", or 42" HIGH**

Square Top and Radius Bottom Panels

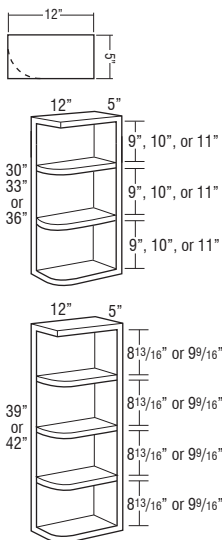

Price Point	1	2	3	4	5	6	7	8	9	10	11	12
WQRES630ST L or R	483	483	483	483	483	483	483	483	483	483	483	483
WQRES633ST L or R	510	510	510	510	510	510	510	510	510	510	510	510
WQRES636ST L or R	535	535	535	535	535	535	535	535	535	535	535	535

WQRES639ST L or R	589	589	589	589	589	589	589	589	589	589	589	589
WQRES642ST L or R	589	589	589	589	589	589	589	589	589	589	589	589

- Specify left or right. Only top panel is square. Right shown.
- Veneer on 3/4" furniture board core with matching interior.
- If ordered with Heirloom Technique, will not feature sand-through characteristics.
- Cabinet features two unfinished back panels. Must be installed with one back panel adjacent to a cabinet of equal height with the other back panel attached to the wall.

MODIFICATIONS
No modifications available for these products.

Construction Upgrades

APC	PE
•	

**WALL QUARTER ROUND END SHELF,
30", 33", 36", 39", or 42" HIGH**

Square Top and Bottom Panels

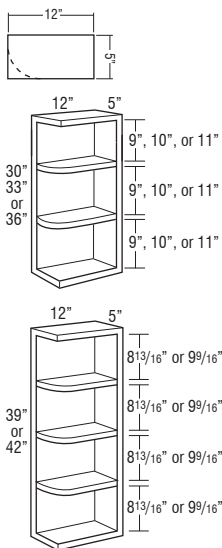

WQRES630STSB	483	483	483	483	483	483	483	483	483	483	483	483
WQRES633STSB	510	510	510	510	510	510	510	510	510	510	510	510
WQRES636STSB	535	535	535	535	535	535	535	535	535	535	535	535

WQRES639STSB	589	589	589	589	589	589	589	589	589	589	589	589
WQRES642STSB	589	589	589	589	589	589	589	589	589	589	589	589

- Units are reversible.
- Veneer on 3/4" furniture board core with matching interior.
- If ordered with Heirloom Technique, will not feature sand-through characteristics.
- Cabinet features two unfinished back panels. Must be installed with one back panel adjacent to a cabinet of equal height with the other back panel attached to the wall.

MODIFICATIONS
No modifications available for these products.

Construction Upgrades

APC	PE
•	

Price Point

WALL QUARTER ROUND END SHELF, 12" RADIUS, 30", 33", 36", 39", or 42" HIGH

Radius Top and Bottom Panels

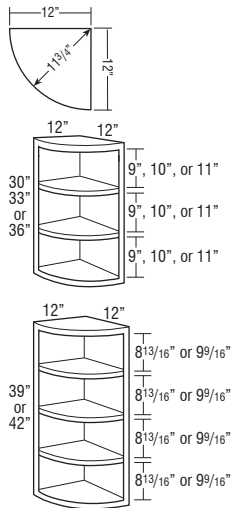

	1	2	3	4	5	6	7	8	9	10	11	12
WQRES1230RT	746	746	746	746	746	746	746	746	746	746	746	746
WQRES1233RT	824	824	824	824	824	824	824	824	824	824	824	824
WQRES1236RT	900	900	900	900	900	900	900	900	900	900	900	900
WQRES1239RT	988	988	988	988	988	988	988	988	988	988	988	988
WQRES1242RT	1052	1052	1052	1052	1052	1052	1052	1052	1052	1052	1052	1052

- Veneer on 3/4" furniture board core with matching interior.
- If ordered with Heirloom Technique, will not feature sand-through characteristics.
- Cabinet features two unfinished back panels. Must be installed with one back panel adjacent to a cabinet of equal height with the other back panel attached to the wall.

MODIFICATIONS
No modifications available for these products.

Construction Upgrades

APC	PE
•	

WALL QUARTER ROUND END SHELF, 12" RADIUS, 30", 33", 36", 39", or 42" HIGH

Square Top and Radius Bottom Panels

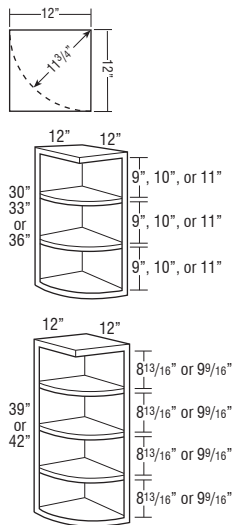

	1	2	3	4	5	6	7	8	9	10	11	12
WQRES1230STRB	746	746	746	746	746	746	746	746	746	746	746	746
WQRES1233STRB	824	824	824	824	824	824	824	824	824	824	824	824
WQRES1236STRB	900	900	900	900	900	900	900	900	900	900	900	900
WQRES1239STRB	988	988	988	988	988	988	988	988	988	988	988	988
WQRES1242STRB	1052	1052	1052	1052	1052	1052	1052	1052	1052	1052	1052	1052

- Veneer on 3/4" furniture board core with matching interior.
- If ordered with Heirloom Technique, will not feature sand-through characteristics.
- Cabinet features two unfinished back panels. Must be installed with one back panel adjacent to a cabinet of equal height with the other back panel attached to the wall.

MODIFICATIONS
No modifications available for these products.

Construction Upgrades

APC	PE
•	

WALL MICROWAVE CABINET, 18" or 21" HIGH

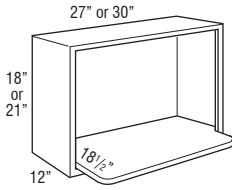

	Opening		Cabinet	
	Width	Height	Width	Height
MW2718	24"	14 1/4"	27"	18"
MW3018	27"	14 1/4"	30"	18"
MW2721	24"	17 1/4"	27"	21"
MW3021	27"	17 1/4"	30"	21"

	Price Point	1	2	3	4	5	6	7	8	9	10	11	12
MW2718		846	846	846	846	846	846	846	846	846	846	846	846
MW3018		846	846	846	846	846	846	846	846	846	846	846	846
MW2721		846	846	846	846	846	846	846	846	846	846	846	846
MW3021		846	846	846	846	846	846	846	846	846	846	846	846

- Includes one 3/4" shelf with six mounting screws. Microwave shelf extends beyond the front of the cabinet by 6 1/2", for a total shelf depth of 18 1/2".
- Microwave cabinet must be attached to wall stud and adjacent cabinets on both sides for support.
- When ID is ordered, shelf will not be included with cabinet.
- When placed at a different height than adjacent cabinets, FPFB modification is recommended.
- If ordered with Heirloom Technique, will not feature sand-through characteristics.

Custom Modifications

ADDTK	AUTH	CBO	CCO	CFNTO	CFRMO	CH	CND	CW	EXBK	EX	FB	FFD	FPEB	ID	INVFRM	MIP	P	PFINBTMB	RD	TD	TVR_V	
	•	STD				•	• ¹		•	•	•		•	•			STD		•			

Construction Upgrades

APC	PE

Door Options

ALF	CG	CG.BTM	CG.TOP	DPSRR	MD	MD.BTM	MD.TOP	MFO

¹ Not available on 18" high

WALL MICROWAVE DOUBLE DOOR CABINET, 36", 39", or 42" HIGH

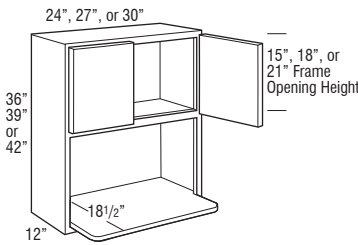

	Opening		Cabinet	
	Width	Height	Width	Height
WMW2436	21"	15 3/4"	24"	36"
WMW2736	24"	15 3/4"	27"	36"
WMW3036	27"	15 3/4"	30"	36"
WMW2439	21"	15 3/4"	24"	39"
WMW2739	24"	15 3/4"	27"	39"
WMW3039	27"	15 3/4"	30"	39"
WMW2442	21"	15 3/4"	24"	42"
WMW2742	24"	15 3/4"	27"	42"
WMW3042	27"	15 3/4"	30"	42"

WMW2436	1625	1794	1847	1900	1952	2004	2130	2213	2298	2383	2448	2653
WMW2736	1625	1794	1847	1900	1952	2004	2130	2213	2298	2383	2448	2653
WMW3036	1710	1883	1939	1995	2051	2106	2230	2320	2410	2499	2567	2781
WMW2439	1608	1775	1828	1879	1932	1984	2109	2191	2275	2360	2425	2626
WMW2739	1691	1865	1920	1975	2029	2083	2215	2302	2389	2480	2547	2760
WMW3039	1739	1920	1976	2032	2088	2144	2279	2368	2458	2550	2621	2838
WMW2442	1755	1938	1995	2051	2108	2164	2300	2389	2482	2574	2644	2866
WMW2742	1820	2008	2068	2126	2185	2243	2386	2479	2574	2670	2743	2971
WMW3042	1852	2045	2106	2165	2224	2284	2428	2522	2620	2717	2792	3025

- Includes one 3/4" shelf with six mounting screws. Microwave shelf extends beyond the front of the cabinet by 6 1/2", for a total shelf depth of 18 1/2".
- 42" high cabinets include one adjustable shelf in the upper section.
- Microwave cabinet must be attached to wall stud and adjacent cabinets on both sides for support.
- When ID is ordered, shelf will not be included with cabinet.
- When placed at a different height than adjacent cabinets, FPFB modification is recommended.

Custom Modifications

ADDTK	AUTH	CBO	CCO	CFNTO	CFRMO	CH	CND	CW	EXBK	EX	FB	FFD	FPEB	ID	INVFRM	MIP	P	PFINBTMB	RD	TD	TVR_V
	•	•	•	•	•	•	• ¹	• ²	•	•	•		•	•			STD		•		

Construction Upgrades

APC	PE

Door Options

ALF	CG	CG.BTM	CG.TOP	DPSRR	MD	MD.BTM	MD.TOP	MFO
•				•				•

¹ Not available on 36" high

² Not available on 24" wide

WALL BUILT-IN MICROWAVE CABINET, 18" or 21" HIGH

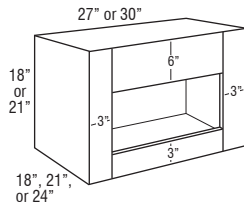

Model	Factory Opening	Maximum Cut-out
WBMW2718..	21W x 9H	25 1/2W x 15H
WBMW2721..	21W x 12H	25 1/2W x 18H
WBMW3018..	24W x 9H	28 1/2W x 15H
WBMW3021..	24W x 12H	28 1/2W x 18H

	Price Point	1	2	3	4	5	6	7	8	9	10	11	12
WBMW271818		734	734	734	734	734	734	734	734	734	734	734	734
WBMW301818		734	734	734	734	734	734	734	734	734	734	734	734
WBMW272118		734	734	734	734	734	734	734	734	734	734	734	734
WBMW302118		734	734	734	734	734	734	734	734	734	734	734	734
WBMW271821		792	792	792	792	792	792	792	792	792	792	792	792
WBMW301821		792	792	792	792	792	792	792	792	792	792	792	792
WBMW272121		792	792	792	792	792	792	792	792	792	792	792	792
WBMW302121		792	792	792	792	792	792	792	792	792	792	792	792
WBMW271824		871	871	871	871	871	871	871	871	871	871	871	871
WBMW301824		871	871	871	871	871	871	871	871	871	871	871	871
WBMW272124		871	871	871	871	871	871	871	871	871	871	871	871
WBMW302124		871	871	871	871	871	871	871	871	871	871	871	871

- WBMWs can be used to stack with other cabinets to create custom appliance cabinet designs.
- Microwave cabinet must be attached to wall stud and adjacent cabinets on both sides for support.
- When placed at a different height than adjacent cabinets, FPEB modification is recommended. When stacking cabinets, a skin or space filler (S96X14) may be required when installing adjacent to cabinets of other depths.
- If ordered with Heirloom Technique, will not feature sand-through characteristics.

Custom Modifications

ADDTK	AUTH	CBO	CCO	CFNTO	CFRMO	CH	CND	CW	EXBK	EX	FB	FFD	FPEB	ID	INVFRM	MIP	P	PFINBTMB	RD	TD	TVR_V	
			•					• ¹														

Construction Upgrades

APC	PE
•	•

Door Options

ALF	CG	CG.BTM	CG.TOP	DPSRR	MD	MD.BTM	MD.TOP	MFO

¹ Not available on 18" high
² Not available on 27" wide

WALL BUILT-IN MICROWAVE DOUBLE DOOR CABINET, 36", 39", or 42" HIGH, 18" or 21" DEEP

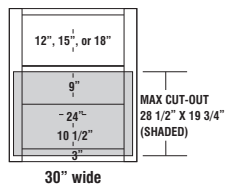
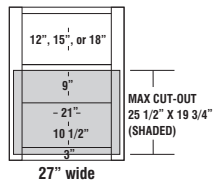
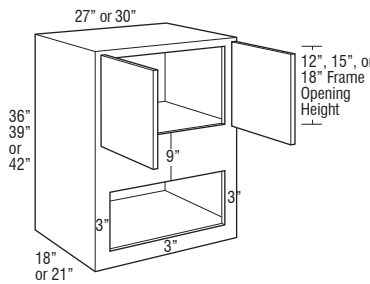

Model	Factory Opening	Maximum Cut-out
WBMW27..	21W x 10 1/2H	25 1/2W x 19 3/4H
WBMW30..	24W x 10 1/2H	28 1/2W x 19 3/4H

WBMW273618	1007	1095	1128	1160	1193	1224	1297	1350	1402	1454	1495	1621
WBMW303618	1060	1149	1183	1216	1250	1284	1360	1416	1472	1524	1568	1695
WBMW273918	1108	1205	1241	1276	1310	1345	1427	1483	1542	1599	1642	1781
WBMW303918	1167	1263	1301	1338	1375	1412	1496	1556	1617	1678	1723	1867
WBMW274218	1208	1312	1351	1390	1429	1467	1558	1618	1682	1745	1792	1940
WBMW304218	1271	1379	1419	1459	1500	1540	1632	1698	1764	1828	1880	2034
WBMW273621	1113	1152	1185	1217	1250	1281	1357	1408	1460	1512	1551	1678
WBMW303621	1165	1207	1241	1275	1308	1341	1416	1475	1529	1583	1625	1754
WBMW273921	1219	1262	1298	1334	1370	1404	1484	1542	1600	1658	1701	1838
WBMW303921	1276	1324	1361	1397	1432	1468	1553	1614	1676	1734	1781	1926
WBMW274221	1326	1372	1411	1449	1487	1525	1618	1677	1742	1801	1848	1998
WBMW304221	1385	1436	1477	1518	1558	1598	1689	1755	1822	1886	1938	2092

- Uses face mount hinges, doors have a consistent width reveal for full overlay (1/4") and partial overlay (1").
- Microwave cabinet must be attached to wall stud and adjacent cabinets on both sides for support.
- All cabinets have 3" stiles on frames.
- When placed at a different height than adjacent cabinets, FPEB modification is recommended. When stacking cabinets, a skin or space filler (S96X14) may be required when installing adjacent to cabinets of other depths.

Custom Modifications

ADDTK	AUTH	CBO	CCO	CFNTO	CFRMO	CH	CND	CW	EXBK	EX	FB	FFD	FPEB	ID	INVFRM	MIP	P	PFINBTMB	RD	TD	TVR_V	

Construction Upgrades

APC	PE
•	•

Door Options

ALF	CG	CG.BTM	CG.TOP	DPSRR	MD	MD.BTM	MD.TOP	MFO

¹ Not available on 18" deep
² Not available on 36" high
³ Not available on 27" wide

WALL APPLIANCE GARAGE DOOR, 18" HIGH, 12" DEEP

12", 15", 18", 21", or 24"

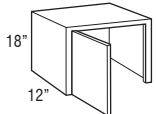

24", 27", 30", 33", or 36"

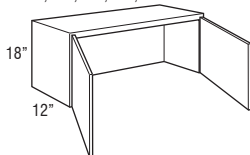

Price Point

	1	2	3	4	5	6	7	8	9	10	11	12
WAGD12 L or R	766	766	766	766	766	766	766	766	766	766	766	766
WAGD15 L or R	791	791	791	791	791	791	791	791	791	791	791	791
WAGD18 L or R	814	814	814	814	814	814	814	814	814	814	814	814
WAGD21 L or R	836	836	836	836	836	836	836	836	836	836	836	836
WAGD24 L or R	878	878	878	878	878	878	878	878	878	878	878	878

WAGD24	922	922	922	922	922	922	922	922	922	922	922	922
WAGD27	951	951	951	951	951	951	951	951	951	951	951	951
WAGD30	978	978	978	978	978	978	978	978	978	978	978	978
WAGD33	1009	1009	1009	1009	1009	1009	1009	1009	1009	1009	1009	1009
WAGD36	1038	1038	1038	1038	1038	1038	1038	1038	1038	1038	1038	1038

• Cabinet does not have floor.

Custom Modifications

ADDTK	AUTH	CBO	CCO	CFNTO	CFRMO	CH	CND	CW	EXBK	EX	FB	FFD	FPEB	ID	INFRM	MIP	P	PFINBTMB	RD	TD	TVR_V	
	•			•					• ¹	•				•								

Construction Upgrades

APC	PE
•	STD

Door Options

ALF	CG	CG.BTM	CG.TOP	DPSRR	MD	MD.BTM	MD.TOP	MFO
	•			•				

¹ Not available on 12" and 24" (2 doors) wide

WALL APPLIANCE GARAGE VERTICAL-LIFT DOOR, 18" HIGH, 12" DEEP

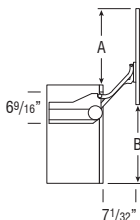
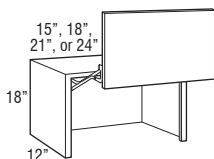

	Full Overlay	Partial Overlay
A	16 13/16"	16 1/16"
B	17 5/16"	18 1/16"

	1725	1814	1837	1858	1880	1902	1949	1992	2025	2042	2068	2144
WAGVLD15												
WAGVLD18	1774	1863	1885	1906	1929	1950	1997	2041	2073	2090	2116	2192
WAGVLD21	1822	1912	1934	1956	1977	1998	2045	2090	2122	2138	2165	2240
WAGVLD24	1872	1961	1982	2004	2025	2046	2094	2138	2172	2186	2213	2289

- Uses standard configuration doors with vertical center panel grain. See Door Style Specifications page in Door Style section for details on doors with grain pattern exceptions.
- Decorative hardware required.
- See side view drawing for required clearances.
- Lift mechanism features a single motion for up and out movement with soft-close, tension can be field adjusted.
- Lift mechanisms and mounting brackets will be visible if used with transparent textured glass.
- Lift mechanism not available for order for field installation, only available factory installed.
- Hardware extends 1" into opening on each side.
- Bottom edge not trimmable.

Custom Modifications

ADDTK	AUTH	CBO	CCO	CFNTO	CFRMO	CH	CND	CW	EXBK	EX	FB	FFD	FPEB	ID	INFRM	MIP	P	PFINBTMB	RD	TD	TVR_V	
	•		•		•				• ¹	•				•								

Construction Upgrades

APC	PE
•	•

Door Options

ALF	CG	CG.BTM	CG.TOP	DPSRR	MD	MD.BTM	MD.TOP	MFO
	•			•				

¹ Not available on 15" wide

CORNER DOOR, 18" HIGH

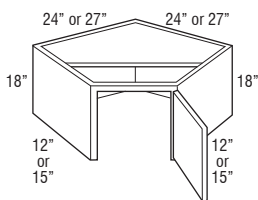

	877	877	877	877	877	877	877	877	877	877	877	877
CD2424 L or R												
CD2727 L or R	1141	1141	1141	1141	1141	1141	1141	1141	1141	1141	1141	1141

- CD2424 L or R requires 24" x 24" corner wall space.
- CD2727 L or R requires 27" x 27" corner wall space.
- Cabinet is designed to fit beneath Diagonal Wall Cabinets.
- Cabinet has partial top and no floor.
- Full overlay styles use the same width doors as partial overlay styles (14 1/2" wide) with a partial overlay hinge (38NPOHINGE) to allow for proper door clearance with adjacent cabinets.

Custom Modifications

ADDTK	AUTH	CBO	CCO	CFNTO	CFRMO	CH	CND	CW	EXBK	EX	FB	FFD	FPEB	ID	INFRM	MIP	P	PFINBTMB	RD	TD	TVR_V	
	•		•	•	•																	

Construction Upgrades

APC	PE
•	•

Door Options

ALF	CG	CG.BTM	CG.TOP	DPSRR	MD	MD.BTM	MD.TOP	MFO
	•			•				

WALL BOX COLUMN PULL-OUT, PLAIN

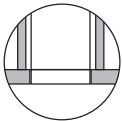
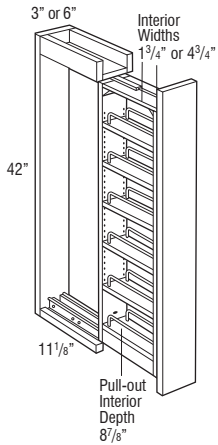
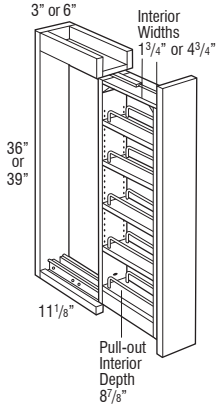
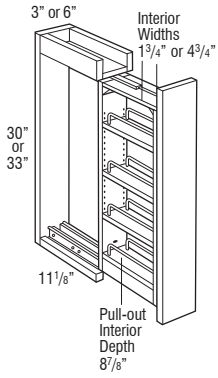

Top View

Price Point	1	2	3	4	5	6	7	8	9	10	11	12
WBCPO330	772	772	772	772	772	772	772	772	772	772	772	772
WBCPO630	990	990	990	990	990	990	990	990	990	990	990	990
WBCPO333	831	831	831	831	831	831	831	831	831	831	831	831
WBCPO633	1049	1049	1049	1049	1049	1049	1049	1049	1049	1049	1049	1049
WBCPO336	890	890	890	890	890	890	890	890	890	890	890	890
WBCPO636	1108	1108	1108	1108	1108	1108	1108	1108	1108	1108	1108	1108
WBCPO339	949	949	949	949	949	949	949	949	949	949	949	949
WBCPO639	1167	1167	1167	1167	1167	1167	1167	1167	1167	1167	1167	1167
WBCPO342	1008	1008	1008	1008	1008	1008	1008	1008	1008	1008	1008	1008
WBCPO642	1226	1226	1226	1226	1226	1226	1226	1226	1226	1226	1226	1226

- Recommend installation between two cabinets. Can be installed on the end of a run or adjacent to an appliance with a 3/4" thick end panel.
- All styles feature a natural finish full extension wood pull-out with adjustable shelves and chrome rail sides.
- If ordered with Heirlooming Technique, will not feature sand-through characteristics.
- In order to allow proper clearance for opening and closing, allow an additional 1/8" space between adjacent cabinet face frames. The 3" wide pull-outs require 3 1/8" space and the 6" wide pull-outs require 6 1/8" space. Spacers are included with the pull-outs to allow for proper installation.
- For full access from both sides of unit, do not install against a wall or next to deeper appliances and cabinets.
- Install unit before removing shipping brace.
- Soft-close guide not featured.

MODIFICATIONS
No modifications available for these products.

Finish Techniques

Heirlooming

WALL BOX COLUMN PULL-OUT, OVERLAY

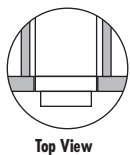
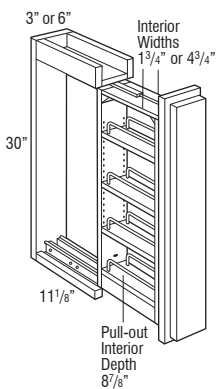

Price Point	1	2	3	4	5	6	7	8	9	10	11	12
WBCPO3300L	827	827	827	827	827	827	827	827	827	827	827	827
WBCPO6300L	1044	1044	1044	1044	1044	1044	1044	1044	1044	1044	1044	1044

- Recommend installation between two cabinets. Can be installed on the end of a run or adjacent to an appliance with a 3/4" thick end panel.
- Overlay application includes profiled full overlay filler.
- All styles feature a natural finish full extension wood pull-out with adjustable shelves and chrome rail sides.
- In order to allow proper clearance for opening and closing, allow an additional 1/8" space between adjacent cabinet face frames. The 3" wide pull-outs require 3 1/8" space and the 6" wide pull-outs require 6 1/8" space. Spacers are included with the pull-outs to allow for proper installation.
- For full access from both sides of unit, do not install against a wall or next to deeper appliances and cabinets.
- Not compatible with face mount moulding.
- Filler is included, but unattached.
- Install unit before removing shipping brace and attaching filler.
- Soft-close guide not featured.

MODIFICATIONS
No modifications available for these products.

Finish Techniques

Heirlooming
•

WALL SPICE PULL-OUT, 30", 33", 36", 39", or 42" HIGH

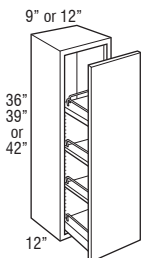
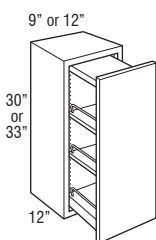

WSP930	922	955	982	1009	1036	1061	1096	1117	1143	1165	1182	1237
WSP1230	967	1016	1041	1064	1089	1113	1146	1170	1197	1221	1254	1313
WSP933	971	1014	1041	1068	1095	1121	1159	1182	1210	1234	1255	1316
WSP1233	1021	1076	1102	1129	1156	1182	1217	1231	1274	1302	1331	1396

WSP936	1016	1075	1102	1127	1153	1179	1220	1248	1275	1305	1327	1394
WSP1236	1073	1136	1165	1193	1221	1249	1291	1321	1350	1385	1406	1477
WSP939	1068	1132	1161	1189	1218	1246	1291	1321	1350	1384	1410	1482
WSP1239	1126	1195	1227	1258	1290	1320	1367	1400	1431	1466	1494	1574
WSP942	1117	1189	1220	1252	1283	1313	1364	1397	1434	1467	1492	1576
WSP1242	1179	1251	1288	1325	1362	1398	1451	1483	1524	1558	1586	1675

- 30" and 33" high units include a natural finish, full extension wood pull-out with two adjustable shelves, one fixed shelf, and chrome finish rail sides.
- Wood plugs for top of 30" and 33" high pull-out included for field installation.
- 36" to 42" high units include a natural finish, full extension wood pull-out with two adjustable shelves, two fixed shelves, and chrome finish rail sides.
- Wire for top rail on 36" to 42" high pull-out included separately for field installation.
- Shelf dimensions for 9" wide cabinets are 4 1/4" wide x 9 1/2" deep. Shelf dimensions for 12" wide cabinets are 7 1/4" wide x 9 1/2" deep.
- For full access from both sides of unit, do not install against a wall or next to deeper appliances and cabinets.

Custom Modifications

ADDTK	AUTH	CBO	CCO	CFNTO	CFRMO	CH	CND	CW	EXBK	EX	FB	FFD	FPEB	ID	INFRM	MIP	P	PFINBTMB	RD	TD	TVR_V	
•	•	•	•		•				•	•	•		•					•				

Construction Upgrades

APC	PE
•	•

Door Options

ALF	CG	CG.BTM	CG.TOP	DPSRR	MD	MD.BTM	MD.TOP	MFO
				•				•

WALL SHELF PULL-DOWN

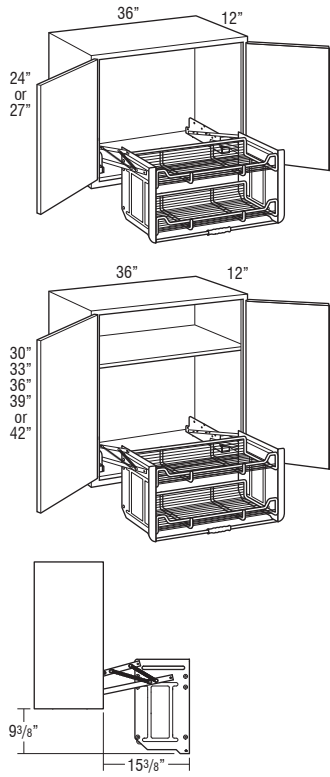

Price Point	1	2	3	4	5	6	7	8	9	10	11	12
W3624SHLFPD	1780	1871	1912	1951	1991	2030	2088	2128	2169	2211	2240	2337
W3627SHLFPD	1840	1958	1990	2023	2055	2088	2148	2192	2235	2276	2310	2414
W3630SHLFPD	1871	2008	2042	2075	2109	2142	2209	2251	2300	2346	2379	2486
W3633SHLFPD	1970	2120	2159	2197	2235	2274	2350	2398	2452	2501	2540	2661
W3636SHLFPD	2070	2231	2276	2319	2363	2407	2486	2542	2603	2658	2701	2837
W3639SHLFPD	2170	2349	2397	2444	2492	2539	2627	2689	2755	2817	2863	3010
W3642SHLFPD	2270	2455	2511	2566	2622	2677	2775	2838	2912	2978	3028	3192

- Shelf Pull-down dimensions: 18 11/64" high x 28 1/4" wide x 8 1/2" deep.
- Interior dimensions of pull-down trays: 28 1/4" wide x 8 1/2" deep.
- Clearance dimensions: 19 3/8" high x 15 3/8" wide.
- 30" to 42" high units will have one adjustable shelf above pull-down unit.
- Maximum Weight Capacity for Shelf Pull-down: 26 lbs.

Custom Modifications

ADDTK	AUTH	CBO	CCO	CFNTO	CFRMO	CH	CND	CW	EXBK	EX	FB	FFD	FPEB	ID	INVFRM	MIP	P	PFINBTMB	RD	TD	TVR_V	
	•	•	•	•	•	• ¹			•	•	•		•			•		•				

Construction Upgrades

APC	PE
•	•

Door Options

ALF	CG	CG.BTM	CG.TOP	DPSRR	MD	MD.BTM	MD.TOP	MFO
	•			•	• ²			•

¹ Not available on 24" and 30" high
² Not available on 27" high

WALL SPICE RACK CABINET, 30", 33", 36", 39", or 42" HIGH

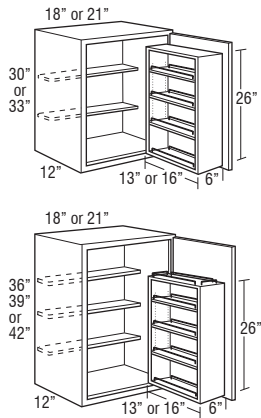

WSR1830 L or R	1208	1342	1406	1468	1532	1595	1690	1758	1827	1893	1947	2109
WSR2130 L or R	1252	1382	1452	1520	1589	1658	1755	1823	1898	1969	2023	2191
WSR1833 L or R	1266	1412	1478	1544	1611	1677	1779	1849	1921	1990	2046	2214
WSR2133 L or R	1316	1459	1530	1600	1671	1742	1845	1917	1992	2066	2121	2299
WSR1836 L or R	1324	1482	1550	1618	1687	1755	1865	1941	2015	2087	2145	2323
WSR2136 L or R	1379	1533	1606	1679	1752	1823	1934	2012	2089	2165	2223	2410
WSR1839 L or R	1411	1588	1664	1740	1817	1892	2003	2081	2166	2241	2307	2498
WSR2139 L or R	1480	1656	1735	1812	1891	1968	2088	2171	2257	2337	2398	2601
WSR1842 L or R	1431	1612	1690	1767	1845	1922	2033	2112	2197	2275	2342	2536
WSR2142 L or R	1500	1682	1762	1840	1920	1998	2118	2205	2289	2376	2437	2641

- Shelves are 4 1/2" deep.
- Field installed swing-out is natural finished wood with three adjustable and one fixed bottom shelf with chrome finish wire rail sides.
- Dimensions: WSR18 wood insert is 26" high x 13" wide x 6" deep. WSR21 wood insert is 26" high x 16" wide x 6" deep.
- When Increased Depth (ID) is ordered, wood insert will not increase in size.
- Maximum Weight Capacity for Spice Rack Shelves: 15 lbs.
- Inserts are packaged separately and are field installed.

Custom Modifications

ADDTK	AUTH	CBO	CCO	CFNTO	CFRMO	CH	CND	CW	EXBK	EX	FB	FFD	FPEB	ID	INVFRM	MIP	P	PFINBTMB	RD	TD	TVR_V	
•	•	•	•	•	•				•	•	•		•	•		•		•				

Construction Upgrades

APC	PE
•	•

Door Options

ALF	CG	CG.BTM	CG.TOP	DPSRR	MD	MD.BTM	MD.TOP	MFO
	•			•	•			•

**WALL WINE RACK,
15", 18", or 30" HIGH**

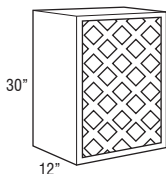
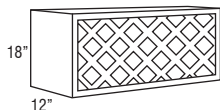
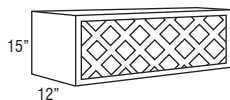

Model	# of Bottles
WNR3015	11
WNR3615	13
WNR3018	11
WNR3618	13
WNR1530	11
WNR1830	11
WNR2130	17

Price Point

	1	2	3	4	5	6	7	8	9	10	11	12
WNR3015	1081	1081	1081	1081	1081	1081	1081	1081	1081	1081	1081	1081
WNR3615	1183	1183	1183	1183	1183	1183	1183	1183	1183	1183	1183	1183
WNR3018	1114	1114	1114	1114	1114	1114	1114	1114	1114	1114	1114	1114
WNR3618	1204	1204	1204	1204	1204	1204	1204	1204	1204	1204	1204	1204
WNR1530	1061	1061	1061	1061	1061	1061	1061	1061	1061	1061	1061	1061
WNR1830	1114	1114	1114	1114	1114	1114	1114	1114	1114	1114	1114	1114
WNR2130	1183	1183	1183	1183	1183	1183	1183	1183	1183	1183	1183	1183

- Cabinet interior finished to match cabinet face frame.
- Solid-wood lattice work.
- Wine bottle opening 4" x 4".
- If ordered with Heirloom Technique, will not feature sand-through characteristics.

Custom Modifications

ADDTK	AUTH	CBO	CCO	CFNTO	CFRMO	CH	CND	CW	EXBK	EX	FB	FFD	FPEB	ID	INVFRM	MIP	P	PFINBTMB	RD	TD	TVR_V	
•		STD			•				•	•			•				STD	•				

Construction Upgrades

APC	PE

Door Options

ALF	CG	CG.BTM	CG.TOP	DPSRR	MD	MD.BTM	MD.TOP	MFO

**WINE STORAGE CABINET,
12", 15", 18", 21", or 24" HIGH**

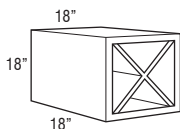
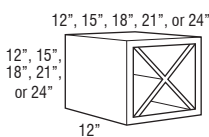

Model	# of Bottles*
WSC121212	4
WSC151512	10
WSC181812	18
WSC212112	24
WSC242412	32
WSC181818	18

	1	2	3	4	5	6	7	8	9	10	11	12
WSC121212	651	651	651	651	651	651	651	651	651	651	651	651
WSC151512	687	687	687	687	687	687	687	687	687	687	687	687
WSC181812	722	722	722	722	722	722	722	722	722	722	722	722
WSC212112	758	758	758	758	758	758	758	758	758	758	758	758
WSC242412	796	796	796	796	796	796	796	796	796	796	796	796
WSC181818	784	784	784	784	784	784	784	784	784	784	784	784

- Must be installed between two cabinets, between a cabinet and a wall, or mounted to a horizontal surface.
- "X" shelf configuration cannot be removed.
- If ordered with Heirloom Technique, will not feature sand-through characteristics.
- Reduced depth not recommended for safe wine bottle storage.

Custom Modifications

ADDTK	AUTH	CBO	CCO	CFNTO	CFRMO	CH	CND	CW	EXBK	EX	FB	FFD	FPEB	ID	INVFRM	MIP	P	PFINBTMB	RD	TD	TVR_V	
									•				•	• ¹		STD		•	•			

Construction Upgrades

APC	PE

Door Options

ALF	CG	CG.BTM	CG.TOP	DPSRR	MD	MD.BTM	MD.TOP	MFO

¹ ID on 12" deep models available up to 18" deep

*Standard 3 1/8" wine bottles.

**WALL CUBE HORIZONTAL,
18", 24", 30", 36", or
42" WIDE, 6" HIGH**

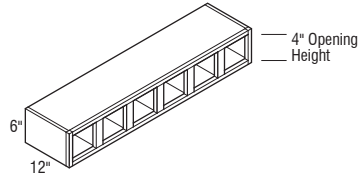

	Price Point	1	2	3	4	5	6	7	8	9	10	11	12
WCH18 (3 openings)		864	864	864	864	864	864	864	864	864	864	864	864
WCH24 (4 openings)		909	909	909	909	909	909	909	909	909	909	909	909
WCH30 (5 openings)		956	956	956	956	956	956	956	956	956	956	956	956
WCH36 (6 openings)		1048	1048	1048	1048	1048	1048	1048	1048	1048	1048	1048	1048
WCH42 (7 openings)		1155	1155	1155	1155	1155	1155	1155	1155	1155	1155	1155	1155

• If ordered with Heirloom Technique, will not feature sand-through characteristics.

Custom Modifications

ADDTK	AUTH	CBO	CCO	CFNTO	CFRMO	CH	CND	CW	EXBK	EX	FB	FFD	FPEB	ID	INVERM	MIP	P	PFINBTMB	RD	TD	TVR_V	
					•				•				•	•		STD						

Construction Upgrades

APC	PE

Door Options

ALF	CG	CG.BTM	CG.TOP	DPSRR	MD	MD.BTM	MD.TOP	MFO

**WALL ORGANIZER,
30", 33", or 36" WIDE,
9" HIGH**

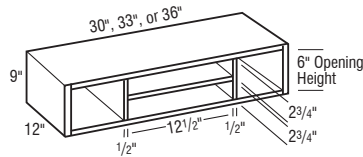

WORG30	956	956	956	956	956	956	956	956	956	956	956	956	956
WORG33	1002	1002	1002	1002	1002	1002	1002	1002	1002	1002	1002	1002	1002
WORG36	1048	1048	1048	1048	1048	1048	1048	1048	1048	1048	1048	1048	1048

• If ordered with Heirloom Technique, will not feature sand-through characteristics.

Custom Modifications

ADDTK	AUTH	CBO	CCO	CFNTO	CFRMO	CH	CND	CW	EXBK	EX	FB	FFD	FPEB	ID	INVERM	MIP	P	PFINBTMB	RD	TD	TVR_V	
					•				•				•	•		STD		•				

Construction Upgrades

APC	PE

Door Options

ALF	CG	CG.BTM	CG.TOP	DPSRR	MD	MD.BTM	MD.TOP	MFO

**APOTHECARY DRAWER
HORIZONTAL,
18", 24", 30", 36", or
42" WIDE, 6" HIGH**

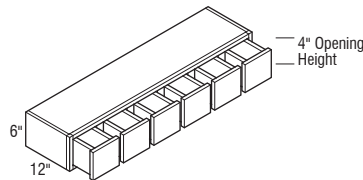

ADH18 (3 drawers)	1169	1169	1169	1169	1169	1169	1169	1169	1169	1169	1169	1169	1169
ADH24 (4 drawers)	1231	1231	1231	1231	1231	1231	1231	1231	1231	1231	1231	1231	1231
ADH30 (5 drawers)	1313	1313	1313	1313	1313	1313	1313	1313	1313	1313	1313	1313	1313
ADH36 (6 drawers)	1435	1435	1435	1435	1435	1435	1435	1435	1435	1435	1435	1435	1435
ADH42 (7 drawers)	1723	1723	1723	1723	1723	1723	1723	1723	1723	1723	1723	1723	1723

- Drawer front is unique to item and will not match profile chosen.
- All styles use standard drawer front profile except shaker door styles, which use the shaker profile.
- 1/2" hardwood drawer with rabbet joint.
- Horizontal application only.
- Does not include soft-close guides. Drawer slides on wooden frame.

Custom Modifications

ADDTK	AUTH	CBO	CCO	CFNTO	CFRMO	CH	CND	CW	EXBK	EX	FB	FFD	FPEB	ID	INVERM	MIP	P	PFINBTMB	RD	TD	TVR_V	
					•				•				•	•		STD						

Construction Upgrades

APC	PE

Door Options

ALF	CG	CG.BTM	CG.TOP	DPSRR	MD	MD.BTM	MD.TOP	MFO

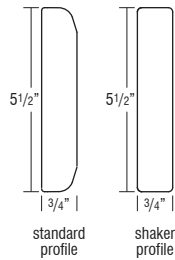

WALL MESSAGE CENTER, 30", 33", 36", 39", or 42" HIGH, 3" DEEP

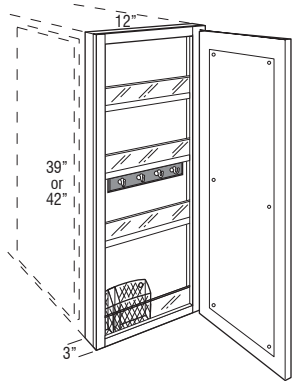
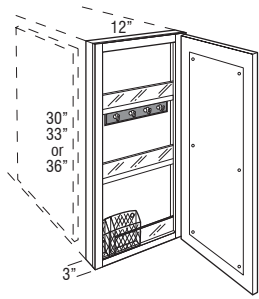

Price Point

	1	2	3	4	5	6	7	8	9	10	11	12
WMC1230 L or R	992	1043	1066	1089	1111	1133	1167	1195	1223	1241	1276	1334
WMC1233 L or R	1047	1103	1128	1152	1177	1202	1238	1258	1299	1323	1352	1417
WMC1236 L or R	1101	1163	1191	1217	1244	1271	1313	1347	1378	1404	1427	1500

WMC1239 L or R	1152	1222	1252	1281	1312	1341	1387	1427	1458	1488	1515	1594
WMC1242 L or R	1207	1278	1314	1348	1383	1418	1471	1511	1549	1580	1608	1693

- Includes magnetic whiteboard on back of door, key hooks, pencil holder, and fixed plexi-glass fronted shelves.
- WMC1230, WMC1233, and WMC1236 have 2 fixed shelves. WMC1239 and WMC1242 have 3 fixed shelves.
- Not recommended for use next to a Peninsula cabinet due to the additional 1/4" cabinet depth.
- Door will open 90° without decorative hardware.
- Cabinet should be hinged on wall side.
- For proper installation, adjacent cabinet must have FPEB or 1/4" skin applied.
- Overlay fillers can be used on side of cabinet to add a decorative touch.

Custom Modifications

ADDTK	AUTH	CBO	CCO	CFNTO	CFRMO	CH	CND	CW	EXBK	EX	FB	FFD	FPEB	ID	INVFRM	MIP	P	PFINBTMB	RD	TD	TVR_V	
		•	•										STD			•						

Construction Upgrades

APC	PE
•	

Door Options

ALF	CG	CG.BTM	CG.TOP	DPSRR	MD	MD.BTM	MD.TOP	MFO
				•				•

CLASSIC ARCH WOOD HOOD, 36", 42", or 48" WIDE

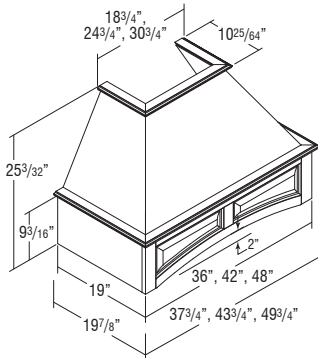

WHA36	4389	4389	4389	4389	4389	4389	4389	4389	4389	4389	4389	4389
WHA42	4702	4702	4702	4702	4702	4702	4702	4702	4702	4702	4702	4702
WHA48	4939	4939	4939	4939	4939	4939	4939	4939	4939	4939	4939	4939

- Freestanding unit (must be properly secured to wall and cannot be attached to adjacent cabinets).
- Exhaust system not included. Compatible with all blowers on page 110.
- Compatible with Classic Wood Hood Chimney (WHC_), which can be trimmed. See page 104.
- Check local building code and appliance installation specifications for clearance requirements and installation heights above the range.
- Silver metallic liner included. Assembly required.
- Arched raised panel valance front.
- Installation instructions and hardware included.
- Liner opening size: 10 1/4" deep by 19 1/2" wide.
- Wood hoods ordered in Rustic Alder and Rustic Hickory will not feature Rustic characteristics.
- No changes or cancellations will be accepted after 24 hours from acknowledgment of order.

MODIFICATIONS

No modifications available for these products.

Finish Techniques

Heirlooming
•

Price Point	1	2	3	4	5	6	7	8	9	10	11	12
-------------	---	---	---	---	---	---	---	---	---	----	----	----

NEW ARTISAN STRAIGHT WOOD HOOD, 30", 36", 42", or 48" WIDE

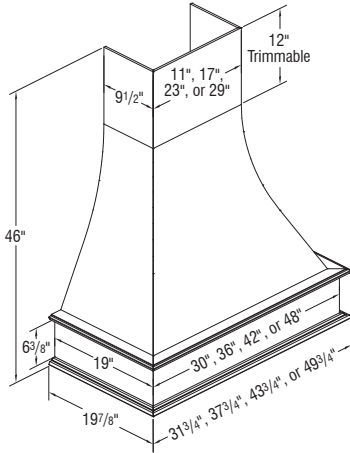

WHAS30	3776	3776	3776	3776	3776	3776	3776	3776	3776	3776	3776	3776
WHAS36	3975	3975	3975	3975	3975	3975	3975	3975	3975	3975	3975	3975
WHAS42	4103	4103	4103	4103	4103	4103	4103	4103	4103	4103	4103	4103
WHAS48	4293	4293	4293	4293	4293	4293	4293	4293	4293	4293	4293	4293

- Freestanding unit (must be properly secured to wall and cannot be attached to adjacent cabinets).
- Chimney height is trimmable up to 34".
- Exhaust system not included. Compatible with all blowers on page 110.
- Check local building code and appliance installation specifications for clearance requirements and installation heights above the range.
- Silver metallic liner included. Assembly required.
- Installation instructions and hardware included.
- Liner opening size: 10 1/4" deep by 19 1/2" wide.
- Wood hoods ordered in Rustic Alder and Rustic Hickory will not feature Rustic characteristics.
- No changes or cancellations will be accepted after 24 hours from acknowledgment of order.

MODIFICATIONS
No modifications available for these products.

Finish Techniques

Heirlooming
•

NEW WATERFALL WOOD HOOD, 36" or 42" WIDE

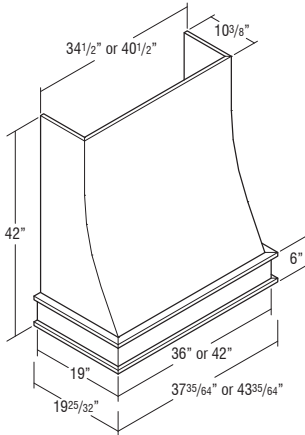

WHWF36	3975	3975	3975	3975	3975	3975	3975	3975	3975	3975	3975	3975
WHWF42	4103	4103	4103	4103	4103	4103	4103	4103	4103	4103	4103	4103

- Freestanding unit (must be properly secured to wall and cannot be attached to adjacent cabinets).
- Exhaust system not included. Compatible with all blowers on page 110.
- Chimney height is trimmable up to 34"
- Check local building code and appliance installation specifications for clearance requirements and installation heights above the range.
- Silver metallic liner included. Assembly required.
- Liner opening size: 10 1/4" deep x 19 1/2" wide.
- Installation instructions and hardware included.
- Wood hoods ordered in Rustic Alder and Rustic Hickory will not feature Rustic characteristics.
- No changes or cancellations will be accepted after 24 hours from acknowledgment of order.

MODIFICATIONS
No modifications available for these products.

Finish Techniques

Heirlooming
•

NEW CRAFTSMAN STRAIGHT WOOD HOOD, 30", 36", 42", or 48" WIDE

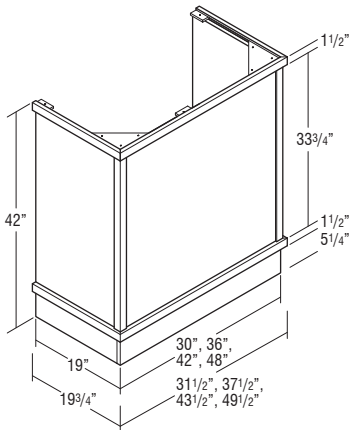

WHCFS30	3387	3387	3387	3387	3387	3387	3387	3387	3387	3387	3387	3387
WHCFS36	3764	3764	3764	3764	3764	3764	3764	3764	3764	3764	3764	3764
WHCFS42	4605	4605	4605	4605	4605	4605	4605	4605	4605	4605	4605	4605
WHCFS48	5066	5066	5066	5066	5066	5066	5066	5066	5066	5066	5066	5066

- Freestanding unit (must be properly secured to wall and cannot be attached to adjacent cabinets).
- Exhaust system not included. Compatible with all blowers on page 110.
- Check local building code and appliance installation specifications for clearance requirements and installation heights above the range.
- Silver metallic liner included. Assembly required.
- Liner opening size: 10 1/4" deep x 19 1/2" wide.
- Installation instructions and hardware included.
- Wood hoods ordered in Rustic Alder and Rustic Hickory will not feature Rustic characteristics.
- No changes or cancellations will be accepted after 24 hours from acknowledgment of order.

MODIFICATIONS
No modifications available for these products.

Finish Techniques

Heirlooming
•



SIGNATURE MANTEL WOOD HOOD, 30" or 36" WIDE, 30" or 36" HIGH

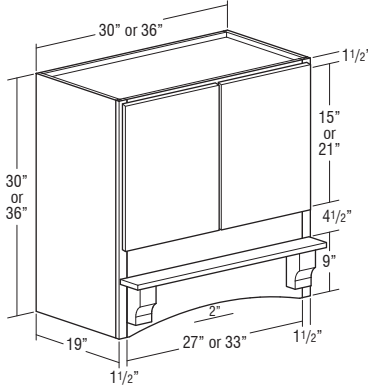

	Price Point	1	2	3	4	5	6	7	8	9	10	11	12
WHSGM3030		3374	3392	3397	3403	3409	3413	3482	3555	3569	3583	3655	3693
WHSGM3036		3650	3669	3674	3679	3683	3688	3763	3840	3856	3873	3952	3992
WHSGM3630		3650	3669	3674	3679	3683	3688	3763	3840	3856	3873	3952	3992
WHSGM3636		4076	4096	4102	4108	4112	4118	4201	4287	4306	4324	4413	4457

- Exhaust system not included. Compatible with all blowers on page 110.
- Operable doors matching the style ordered will be installed on hood.
- Check local building code and appliance installation specifications for clearance requirements and installation heights above the range.
- Silver metallic liner included. Assembly required.
- Liner opening size: 10 1/4" deep x 19 1/2" wide.
- Installation instructions and hardware included.
- When ordering Rustic Alder or Rustic Hickory, only the doors will feature rustic characteristics.
- No changes or cancellations will be accepted after 24 hours from acknowledgment of order.

MODIFICATIONS
No modifications available for these products.

Door Options
ALF CG CG.BTM CG.TOP DPSRR MD MD.BTM MD.TOP MFO
•

Finish Techniques
Heirlooming
•

CLASSIC SQUARE WOOD HOOD, 30", 36", 42", or 48" WIDE

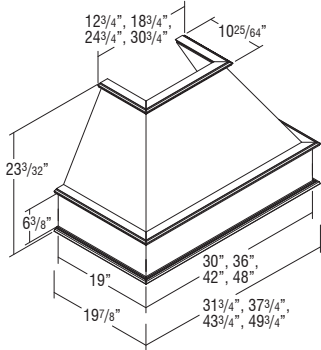

WHS30	3776	3776	3776	3776	3776	3776	3776	3776	3776	3776	3776	3776	3776
WHS36	3975	3975	3975	3975	3975	3975	3975	3975	3975	3975	3975	3975	3975
WHS42	4103	4103	4103	4103	4103	4103	4103	4103	4103	4103	4103	4103	4103
WHS48	4293	4293	4293	4293	4293	4293	4293	4293	4293	4293	4293	4293	4293

- Freestanding unit (must be properly secured to wall and cannot be attached to adjacent cabinets).
- Exhaust system not included. Compatible with all blowers on page 110.
- Compatible with Classic Wood Hood Chimney (WHC_), which can be trimmed. See page 104.
- Check local building code and appliance installation specifications for clearance requirements and installation heights above the range.
- Silver metallic liner included. Assembly required.
- Installation instructions and hardware included.
- Liner opening size: 10 1/4" deep by 19 1/2" wide.
- Wood hoods ordered in Rustic Alder and Rustic Hickory will not feature Rustic characteristics.
- No changes or cancellations will be accepted after 24 hours from acknowledgment of order.

MODIFICATIONS
No modifications available for these products.

Finish Techniques
Heirlooming
•

ARCH FLAT PANEL WOOD HOOD, 30", 36", 42", or 48" WIDE

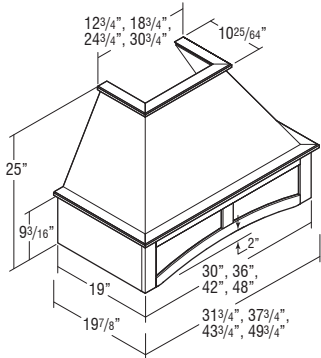

WHAFP30	4128	4128	4128	4128	4128	4128	4128	4128	4128	4128	4128	4128	4128
WHAFP36	4170	4170	4170	4170	4170	4170	4170	4170	4170	4170	4170	4170	4170
WHAFP42	4467	4467	4467	4467	4467	4467	4467	4467	4467	4467	4467	4467	4467
WHAFP48	4692	4692	4692	4692	4692	4692	4692	4692	4692	4692	4692	4692	4692

- Freestanding unit (must be properly secured to wall and cannot be attached to adjacent cabinets).
- Exhaust system not included. Compatible with all blowers on page 110.
- Compatible with Classic Wood Hood Chimney (WHC_), which can be trimmed. See page 104.
- Check local building code and appliance installation specifications for clearance requirements and installation heights above the range.
- Silver metallic liner included. Assembly required.
- Installation instructions and hardware included.
- Liner opening size: 10 1/4" deep by 19 1/2" wide.
- Wood hoods ordered in Rustic Alder and Rustic Hickory will not feature Rustic characteristics.
- No changes or cancellations will be accepted after 24 hours from acknowledgment of order.

MODIFICATIONS
No modifications available for these products.

Finish Techniques
Heirlooming
•

SQUARE FLAT PANEL WOOD HOOD, 30", 36", 42", or 48" WIDE

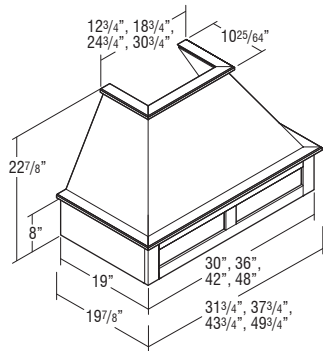

Price Point	1	2	3	4	5	6	7	8	9	10	11	12
WHSFP30	3935	3935	3935	3935	3935	3935	3935	3935	3935	3935	3935	3935
WHSFP36	3975	3975	3975	3975	3975	3975	3975	3975	3975	3975	3975	3975
WHSFP42	4103	4103	4103	4103	4103	4103	4103	4103	4103	4103	4103	4103
WHSFP48	4293	4293	4293	4293	4293	4293	4293	4293	4293	4293	4293	4293

- Freestanding unit (must be properly secured to wall and cannot be attached to adjacent cabinets).
- Exhaust system not included. Compatible with all blowers on page 110.
- Compatible with Classic Wood Hood Chimney (WHC__), which can be trimmed. See page 104.
- Check local building code and appliance installation specifications for clearance requirements and installation heights above the range.
- Silver metallic liner included. Assembly required.
- Installation instructions and hardware included.
- Liner opening size: 10 1/4" deep by 19 1/2" wide.
- Wood hoods ordered in Rustic Alder and Rustic Hickory will not feature Rustic characteristics.
- No changes or cancellations will be accepted after 24 hours from acknowledgment of order.

MODIFICATIONS
No modifications available for these products.

Finish Techniques

Heirlooming
•

CLASSIC WOOD HOOD CHIMNEY, 23 1/2" or 31" HIGH

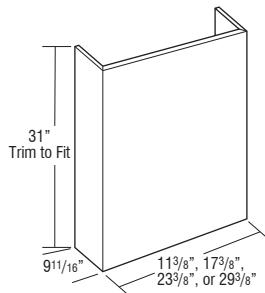
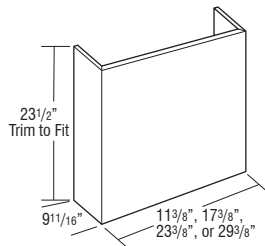

WHC30	748	748	748	748	748	748	748	748	748	748	748	748
WHC36	748	748	748	748	748	748	748	748	748	748	748	748
WHC42	875	875	875	875	875	875	875	875	875	875	875	875
WHC48	953	953	953	953	953	953	953	953	953	953	953	953

WHCT30	942	942	942	942	942	942	942	942	942	942	942	942
WHCT36	942	942	942	942	942	942	942	942	942	942	942	942
WHCT42	1103	1103	1103	1103	1103	1103	1103	1103	1103	1103	1103	1103
WHCT48	1201	1201	1201	1201	1201	1201	1201	1201	1201	1201	1201	1201

- 3/4" thick plywood.
- Trimable.
- If trimmed, moulding is recommended to conceal any cut marks.
- Optional accessory for Classic Arch Wood Hood (WHA), Classic Square Wood Hood (WHS), Arch Flat Panel Wood Hood (WHAFP), and Square Flat Panel Wood Hood (WHSFP).
- WHC30 and WHCT30 are not compatible with CONVERSION.
- Wood hoods ordered in Rustic Alder and Rustic Hickory will not feature Rustic characteristics.
- No changes or cancellations will be accepted after 24 hours from acknowledgment of order.

MODIFICATIONS
No modifications available for these products.

Finish Techniques

Heirlooming
•

LINEAR TAPERED WOOD HOOD, 30", 36", or 42" WIDE

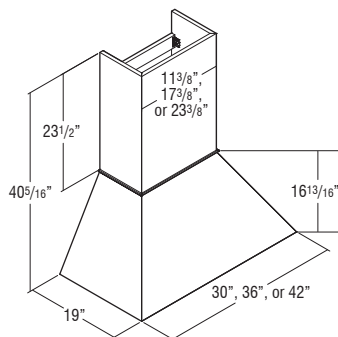

JWHL30	3853	3853	3853	3853	3853	3853	3853	3853	3853	3853	3853	3853
JWHL36	4103	4103	4103	4103	4103	4103	4103	4103	4103	4103	4103	4103
JWHL42	4293	4293	4293	4293	4293	4293	4293	4293	4293	4293	4293	4293

- Freestanding unit (must be properly secured to wall and cannot be attached to adjacent cabinets).
- Exhaust system not included. Compatible with all blowers on page 110.
- Chimney included and can be trimmed.
- Check local building code and appliance installation specifications for clearance requirements and installation heights above the range.
- Silver metallic liner included. Assembly required.
- Installation instructions and hardware included.
- Liner opening size: 10 1/4" deep by 19 1/2" wide.
- Wood hoods ordered in Rustic Alder and Rustic Hickory will not feature Rustic characteristics.
- Available in glaze finishes, but wood hood design does not provide detail for glaze hang-up.
- No changes or cancellations will be accepted after 24 hours from acknowledgment of order.

MODIFICATIONS
No modifications available for these products.

Price Point

1 2 3 4 5 6 7 8 9 10 11 12

SHIPLAP STRAIGHT WOOD HOOD, 36", 42", or 48" WIDE

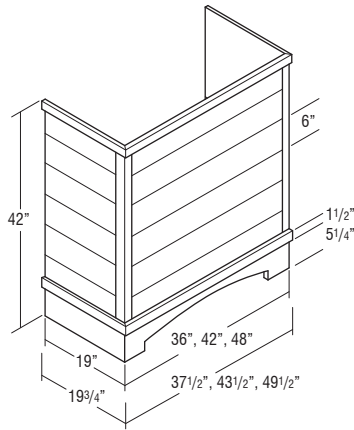

JWHSHPSTR36	4566	4566	4566	4566	4566	4566	4566	4566	4566	4566	4566	4566
JWHSHPSTR42	4694	4694	4694	4694	4694	4694	4694	4694	4694	4694	4694	4694
JWHSHPSTR48	4884	4884	4884	4884	4884	4884	4884	4884	4884	4884	4884	4884

- Freestanding unit (must be properly secured to wall and cannot be attached to adjacent cabinets).
- Constructed of 3/4" thick grooved plywood creating a shiplap appearance.
- Trimmable. If trimmed, moulding is recommended to conceal any cut marks.
- Exhaust system not included. Compatible with all blowers on page 110.
- Check local building code and appliance installation specifications for clearance requirements and installation heights above the range.
- Silver metallic liner included. Assembly required.
- Installation instructions and hardware included.
- Liner opening size: 10 1/4" deep by 19 1/2" wide.
- Wood hoods ordered in Rustic Alder will not feature Rustic characteristics.
- Not available in Rustic Hickory.
- No changes or cancellations will be accepted after 24 hours from acknowledgment of order.

MODIFICATIONS
No modifications available for these products.

Finish Techniques
Heirlooming
•

SHIPLAP STRAIGHT WOOD HOOD with CORBELS, 36", 42", or 48" WIDE

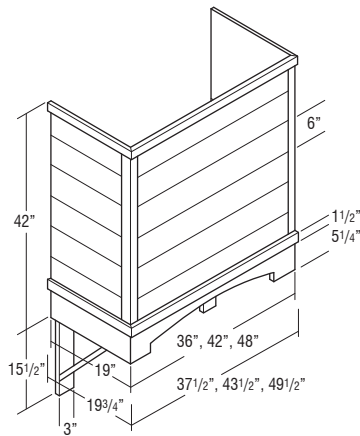

JWHSHPSTRCB36	4889	4889	4889	4889	4889	4889	4889	4889	4889	4889	4889	4889
JWHSHPSTRCB42	5017	5017	5017	5017	5017	5017	5017	5017	5017	5017	5017	5017
JWHSHPSTRCB48	5207	5207	5207	5207	5207	5207	5207	5207	5207	5207	5207	5207

- Includes a pair of decorative corbels.
- Freestanding unit (must be properly secured to wall and cannot be attached to adjacent cabinets).
- Constructed of 3/4" thick grooved plywood creating a shiplap appearance.
- Trimmable. If trimmed, moulding is recommended to conceal any cut marks.
- Exhaust system not included. Compatible with all blowers on page 110.
- Check local building code and appliance installation specifications for clearance requirements (including corbels) and installation heights above the range.
- Silver metallic liner included. Assembly required.
- Installation instructions and hardware included.
- Liner opening size: 10 1/4" deep by 19 1/2" wide.
- Wood hoods ordered in Rustic Alder will not feature Rustic characteristics.
- Not available in Rustic Hickory.
- No changes or cancellations will be accepted after 24 hours from acknowledgment of order.

MODIFICATIONS
No modifications available for these products.

Finish Techniques
Heirlooming
•

SHIPLAP TAPERED WOOD HOOD, 30", 36", 42", or 48" WIDE

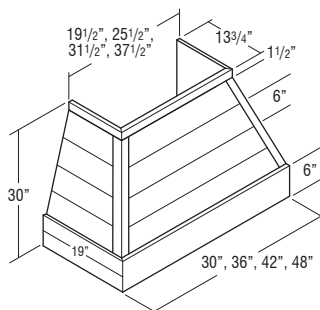

JWHSIPT30	4389	4389	4389	4389	4389	4389	4389	4389	4389	4389	4389	4389
JWHSIPT36	4980	4980	4980	4980	4980	4980	4980	4980	4980	4980	4980	4980
JWHSIPT42	5293	5293	5293	5293	5293	5293	5293	5293	5293	5293	5293	5293
JWHSIPT48	5530	5530	5530	5530	5530	5530	5530	5530	5530	5530	5530	5530

- Freestanding unit (must be properly secured to wall and cannot be attached to adjacent cabinets).
- Constructed of 3/4" thick grooved plywood creating a shiplap appearance.
- Exhaust system not included. Compatible with all blowers on page 110.
- Compatible with Shiplap Wood Hood Chimney (JWHSHPCH_), which can be trimmed. See page 106.
- Check local building code and appliance installation specifications for clearance requirements and installation heights above the range.
- Silver metallic liner included. Assembly required.
- Installation instructions and hardware included.
- Liner opening size: 10 1/4" deep by 19 1/2" wide.
- Wood hoods ordered in Rustic Alder will not feature Rustic characteristics.
- Not available in Rustic Hickory.
- No changes or cancellations will be accepted after 24 hours from acknowledgment of order.

MODIFICATIONS
No modifications available for these products.

Finish Techniques
Heirlooming
•

SHIPLAP TAPERED WOOD HOOD with CORBELS, 36", 42", or 48" WIDE

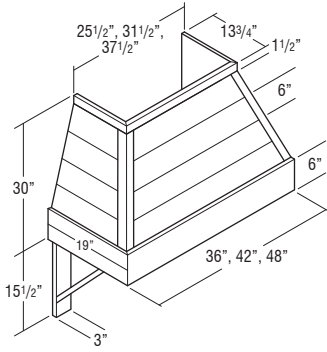

Price Point	1	2	3	4	5	6	7	8	9	10	11	12
JWHSIPTCB36	5303	5303	5303	5303	5303	5303	5303	5303	5303	5303	5303	5303
JWHSIPTCB42	5616	5616	5616	5616	5616	5616	5616	5616	5616	5616	5616	5616
JWHSIPTCB48	5853	5853	5853	5853	5853	5853	5853	5853	5853	5853	5853	5853

- Includes a pair of decorative corbels.
- Freestanding unit (must be properly secured to wall and cannot be attached to adjacent cabinets).
- Constructed of 3/4" thick grooved plywood creating a shiplap appearance.
- Exhaust system not included. Compatible with all blowers on page 110.
- Compatible with Shiplap Wood Hood Chimney (JWHSIPCH__), which can be trimmed. See page 106.
- Check local building code and appliance installation specifications for clearance requirements (including corbels) and installation heights above the range.
- Silver metallic liner included. Assembly required.
- Installation instructions and hardware included.
- Liner opening size: 10 1/4" deep by 19 1/2" wide.
- Wood hoods ordered in Rustic Alder will not feature Rustic characteristics.
- Not available in Rustic Hickory.
- No changes or cancellations will be accepted after 24 hours from acknowledgment of order.

MODIFICATIONS
No modifications available for these products.

Finish Techniques

Heirlooming
•

SHIPLAP WOOD HOOD CHIMNEY, 24 3/4" HIGH

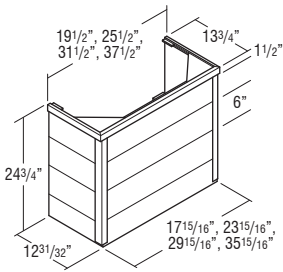

JWHSIPCH30	1339	1339	1339	1339	1339	1339	1339	1339	1339	1339	1339	1339
JWHSIPCH36	1339	1339	1339	1339	1339	1339	1339	1339	1339	1339	1339	1339
JWHSIPCH42	1466	1466	1466	1466	1466	1466	1466	1466	1466	1466	1466	1466
JWHSIPCH48	1544	1544	1544	1544	1544	1544	1544	1544	1544	1544	1544	1544

- Constructed of 3/4" thick grooved plywood creating a shiplap appearance.
- Trimable. If trimmed, moulding is recommended to conceal any cut marks.
- Optional accessory for Shiplap Tapered Wood Hoods (JWHSIPT__ and JWHSIPTCB__) for an installed height of 54".
- Wood hoods ordered in Rustic Alder will not feature Rustic characteristics.
- Not available in Rustic Hickory.
- No changes or cancellations will be accepted after 24 hours from acknowledgment of order.

MODIFICATIONS
No modifications available for these products.

Finish Techniques

Heirlooming
•

SIMPLE TAPERED WOOD HOOD, 30", 36", 42", or 48" WIDE

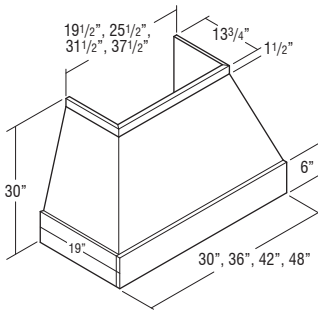

WHSMT30	4389	4389	4389	4389	4389	4389	4389	4389	4389	4389	4389	4389
WHSMT36	4981	4981	4981	4981	4981	4981	4981	4981	4981	4981	4981	4981
WHSMT42	5293	5293	5293	5293	5293	5293	5293	5293	5293	5293	5293	5293
WHSMT48	5531	5531	5531	5531	5531	5531	5531	5531	5531	5531	5531	5531

- Freestanding unit (must be properly secured to wall and cannot be attached to adjacent cabinets).
- Exhaust system not included. Compatible with all blowers on page 110.
- Compatible with Simple Wood Hood Chimney (WHSMT__), which can be trimmed. See page 107.
- Check local building code and appliance installation specifications for clearance requirements and installation heights above the range.
- Silver metallic liner included. Assembly required.
- Installation instructions and hardware included.
- Liner opening size: 10 1/4" deep by 19 1/2" wide.
- Wood hoods ordered in Rustic Alder will not feature Rustic characteristics.
- Not available in Rustic Hickory.
- No changes or cancellations will be accepted after 24 hours from acknowledgment of order.

MODIFICATIONS
No modifications available for these products.

Finish Techniques

Heirlooming
•

**SIMPLE WOOD HOOD CHIMNEY,
24 3/4" HIGH**

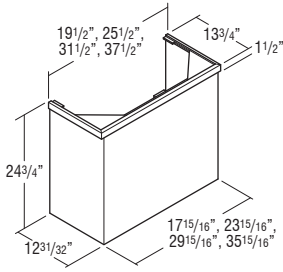

	Price Point	1	2	3	4	5	6	7	8	9	10	11	12
WHSMC30		1341	1341	1341	1341	1341	1341	1341	1341	1341	1341	1341	1341
WHSMC36		1341	1341	1341	1341	1341	1341	1341	1341	1341	1341	1341	1341
WHSMC42		1466	1466	1466	1466	1466	1466	1466	1466	1466	1466	1466	1466
WHSMC48		1544	1544	1544	1544	1544	1544	1544	1544	1544	1544	1544	1544

- Trimmable. If trimmed, moulding is recommended to conceal any cut marks.
- Optional accessory for Simple Tapered Wood Hoods (WHSMT_) for an installed height of 54".
- Wood hoods ordered in Rustic Alder will not feature Rustic characteristics.
- Not available in Rustic Hickory.
- No changes or cancellations will be accepted after 24 hours from acknowledgment of order.

MODIFICATIONS
No modifications available for these products.

Finish Techniques

Heirlooming
•

**CANOPY ARCH WOOD HOOD,
30" or 36" WIDE, 24" HIGH**

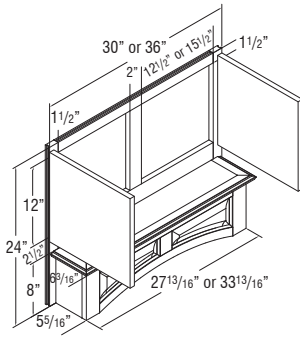

WHCA30	2994	3008	3014	3018	3023	3027	3089	3152	3165	3179	3244	3276
WHCA36	3233	3249	3254	3258	3263	3267	3334	3403	3417	3431	3501	3537

- Install between adjacent cabinets.
- Doors matching the style ordered will be installed on hood.
- Exhaust system not included. Compatible with all blowers on page 110.
- Check local building code and appliance installation specifications for clearance requirements and installation heights above the range.
- Silver metallic liner included. Assembly required. Liner is not arched.
- Installation instructions and hardware included.
- Liner opening size: 10 1/4" deep by 19 1/2" wide.
- When ordered in Rustic Alder or Rustic Hickory, only the doors will have Rustic characteristics.
- Arched raised panel valance front.
- No changes or cancellations will be accepted after 24 hours from acknowledgment of order.

MODIFICATIONS
No modifications available for these products.

Door Options

ALF	CG	CG.BTM	CG.TOP	DPSRR	MD	MD.BTM	MD.TOP	MFO
								•

Finish Techniques

Heirlooming
•

**CANOPY ARCH WOOD HOOD,
30" or 36" WIDE, 30" HIGH**

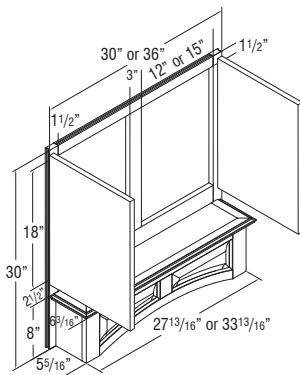

JWHCA3030	3276	3293	3298	3304	3310	3314	3381	3451	3465	3479	3549	3585
JWHCA3630	3544	3562	3567	3572	3576	3581	3653	3728	3744	3760	3837	3876

- Install between adjacent cabinets.
- Doors matching the style ordered will be installed on hood.
- Exhaust system not included. Compatible with all blowers on page 110.
- Check local building code and appliance installation specifications for clearance requirements and installation heights above the range.
- Silver metallic liner included. Assembly required. Liner is not arched.
- Installation instructions and hardware included.
- Liner opening size: 10 1/4" deep by 19 1/2" wide.
- When ordered in Rustic Alder or Rustic Hickory, only the doors will have Rustic characteristics.
- Arched raised panel valance front.
- No changes or cancellations will be accepted after 24 hours from acknowledgment of order.

MODIFICATIONS
No modifications available for these products.

Door Options

ALF	CG	CG.BTM	CG.TOP	DPSRR	MD	MD.BTM	MD.TOP	MFO
								•

Finish Techniques

Heirlooming
•

CANOPY SQUARE WOOD HOOD, 30" or 36" WIDE, 24" HIGH

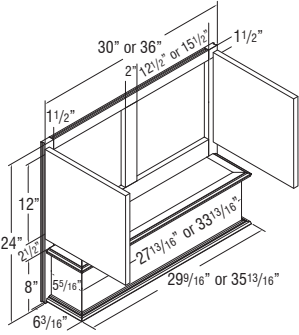

WHCS30	2672	2686	2690	2694	2698	2701	2756	2812	2825	2837	2895	2924
WHCS36	2887	2902	2906	2911	2915	2919	2978	3039	3052	3064	3127	3158

- Install between adjacent cabinets.
- Doors matching the style ordered will be installed on hood.
- Exhaust system not included. Compatible with all blowers on page 110.
- Check local building code and appliance installation specifications for clearance requirements and installation heights above the range.
- Silver metallic liner included. Assembly required.
- Installation instructions and hardware included.
- Liner opening size: 10 1/4" deep by 19 1/2" wide.
- When ordered in Rustic Alder or Rustic Hickory, only the doors will have Rustic characteristics.
- No changes or cancellations will be accepted after 24 hours from acknowledgment of order.

MODIFICATIONS
No modifications available for these products.

Door Options								
ALF	CG	CG.BTM	CG.TOP	DPSRR	MD	MD.BTM	MD.TOP	MFO
								•

Finish Techniques
Heirlooming
•

CANOPY SQUARE WOOD HOOD, 30" or 36" WIDE, 30" HIGH

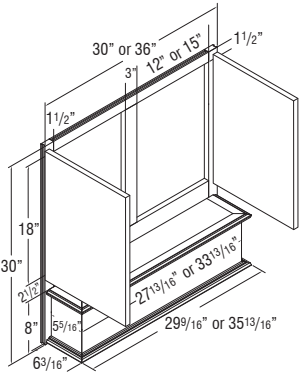

JWHCS3030	2928	2942	2947	2950	2955	2958	3018	3080	3093	3107	3171	3203
JWHCS3630	3161	3176	3182	3186	3192	3196	3261	3328	3342	3356	3424	3459

- Install between adjacent cabinets.
- Doors matching the style ordered will be installed on hood.
- Exhaust system not included. Compatible with all blowers on page 110.
- Check local building code and appliance installation specifications for clearance requirements and installation heights above the range.
- Silver metallic liner included. Assembly required.
- Installation instructions and hardware included.
- Liner opening size: 10 1/4" deep by 19 1/2" wide.
- When ordered in Rustic Alder or Rustic Hickory, only the doors will have Rustic characteristics.
- No changes or cancellations will be accepted after 24 hours from acknowledgment of order.

MODIFICATIONS
No modifications available for these products.

Door Options								
ALF	CG	CG.BTM	CG.TOP	DPSRR	MD	MD.BTM	MD.TOP	MFO
								•

Finish Techniques
Heirlooming
•

STRAIGHT BATTEN WOOD HOOD, 30" or 36" WIDE, 24" or 30" HIGH

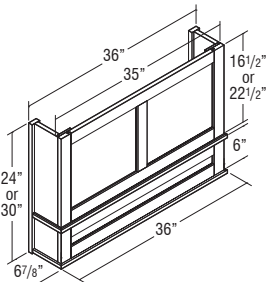
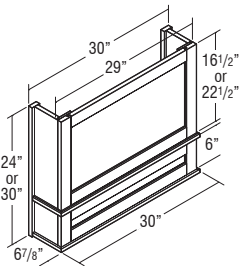

WHSBATTEN3024	3037	3037	3037	3037	3037	3037	3037	3037	3037	3037	3037	3037
WHSBATTEN3030	3387	3387	3387	3387	3387	3387	3387	3387	3387	3387	3387	3387

WHSBATTEN3624	3342	3342	3342	3342	3342	3342	3342	3342	3342	3342	3342	3342
WHSBATTEN3630	3764	3764	3764	3764	3764	3764	3764	3764	3764	3764	3764	3764

- Install between adjacent cabinets.
- Exhaust system not included. Compatible with all blowers on page 110.
- Check local building code and appliance installation specifications for clearance requirements and installation heights above the range.
- Silver metallic liner included. Assembly required.
- Installation instructions and hardware included.
- Liner opening size: 10 1/4" deep by 19 1/2" wide.
- End rails, side stiles, and center stiles are 2 1/4" wide.
- Grain runs vertical on center panels in upper section and horizontal on center panel in lower section.
- Wood hoods ordered in Rustic Alder and Rustic Hickory will not feature Rustic characteristics.
- No changes or cancellations will be accepted after 24 hours from acknowledgment of order.

MODIFICATIONS
No modifications available for these products.

Finish Techniques
Heirlooming
•

**STRAIGHT BATTEN WOOD HOOD,
30", 36", or 42" WIDE, 36" HIGH**

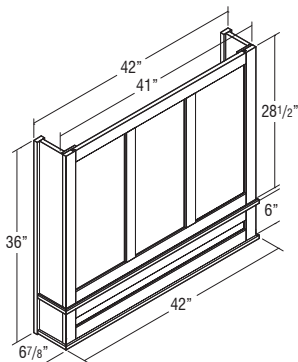
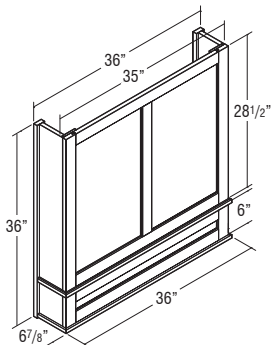
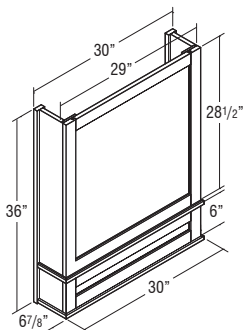

Price Point	1	2	3	4	5	6	7	8	9	10	11	12
WHSBATTEN3036	3737	3737	3737	3737	3737	3737	3737	3737	3737	3737	3737	3737

WHSBATTEN3636	4185	4185	4185	4185	4185	4185	4185	4185	4185	4185	4185	4185
----------------------	------	------	------	------	------	------	------	------	------	------	------	------

WHSBATTEN4236	4605	4605	4605	4605	4605	4605	4605	4605	4605	4605	4605	4605
----------------------	------	------	------	------	------	------	------	------	------	------	------	------

- Install between adjacent cabinets.
- Exhaust system not included. Compatible with all blowers on page 110.
- Check local building code and appliance installation specifications for clearance requirements and installation heights above the range.
- Silver metallic liner included. Assembly required.
- Installation instructions and hardware included.
- Liner opening size: 10 1/4" deep by 19 1/2" wide.
- End rails, side stiles, and center stiles are 2 1/4" wide.
- Grain runs vertical on center panels in upper section and horizontal on center panel in lower section.
- Wood hoods ordered in Rustic Alder and Rustic Hickory will not feature Rustic characteristics.
- No changes or cancellations will be accepted after 24 hours from acknowledgment of order.

MODIFICATIONS
No modifications available for these products.

Finish Techniques

Heirlooming
•

**TAPERED WOOD HOOD,
30" or 36" WIDE, 24" HIGH**

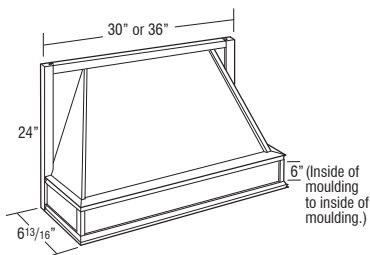

TWH30	1483	1483	1483	1483	1483	1483	1483	1483	1483	1483	1483	1483
--------------	------	------	------	------	------	------	------	------	------	------	------	------

TWH36FW	1622	1622	1622	1622	1622	1622	1622	1622	1622	1622	1622	1622
----------------	------	------	------	------	------	------	------	------	------	------	------	------

- Install between adjacent cabinets.
- Exhaust system not included. Compatible with all blowers on page 110.
- Check local building code and appliance installation specifications for clearance requirements and installation heights above the range.
- Tapered design.
- Liner opening size: 10 1/4" deep x 19 1/2" wide.
- Silver metallic liner included, not available for order separately.
- Wood hoods ordered in Rustic Alder and Rustic Hickory will not feature Rustic characteristics.
- No changes or cancellations will be accepted after 24 hours from acknowledgment of order.

MODIFICATIONS
No modifications available for these products.

Finish Techniques

Heirlooming

WOOD HOOD BLOWER, 600 CFM

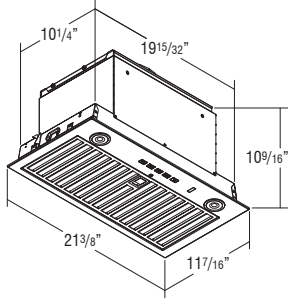

BLOWER600

1	2	3	4	5	6	7	8	9	10	11	12
3006	3006	3006	3006	3006	3006	3006	3006	3006	3006	3006	3006

- 600 CFM.
- Two 3 watt (300+ Lumens, 3 settings) LED lights included.
- Installation instructions and repair information included.
- Stainless Steel finish.
- Four speed push button control.
- Includes removable dishwasher safe grease filter.
- WIFI Enabled, Auto-Sensing, and Heat Sentry technology included.
- 1 year warranty.
- Compatible with all Wood Hoods and Hearths.

MODIFICATIONS

No modifications available for these products.

WOOD HOOD BLOWER, 400 CFM

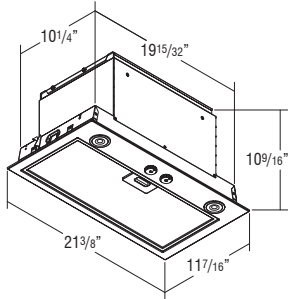

BLOWER400

1411	1411	1411	1411	1411	1411	1411	1411	1411	1411	1411	1411
------	------	------	------	------	------	------	------	------	------	------	------

- 400 CFM, Energy Star rated.
- Two 2.8 watt (250+ Lumens) LED lights included.
- Installation instructions and repair information included.
- Stainless Steel finish.
- Three speed rotary switch control.
- Includes removable dishwasher safe grease filter.
- Heat Sentry technology included.
- 1 year warranty.
- Compatible with all Wood Hoods and Hearths.

MODIFICATIONS

No modifications available for these products.

WOOD HOOD BLOWER, 250 CFM

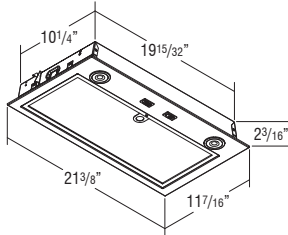

BLOWER250

728	728	728	728	728	728	728	728	728	728	728	728
-----	-----	-----	-----	-----	-----	-----	-----	-----	-----	-----	-----

- 250 CFM.
- Two 2.8 watt (250+ Lumens) LED lights included.
- Installation instructions and repair information included.
- Stainless Steel finish.
- Two speed rocker switch control.
- Includes removable dishwasher safe grease filter.
- Sound rating is 8.0 sones on highest setting.
- Vertical ducting requires 7" diameter vent.
- 1 year warranty.
- Compatible with all Wood Hoods and Hearths.

MODIFICATIONS

No modifications available for these products.

WOOD HOOD INTERIOR DUCTWORK CONVERSION KIT

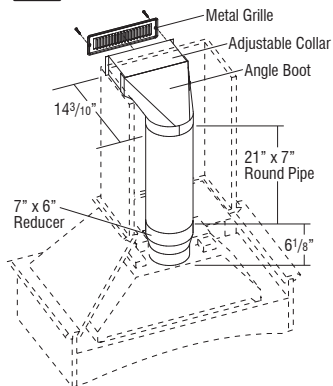

CONVERSION

285	285	285	285	285	285	285	285	285	285	285	285
-----	-----	-----	-----	-----	-----	-----	-----	-----	-----	-----	-----

FILTERCHAR

132	132	132	132	132	132	132	132	132	132	132	132
-----	-----	-----	-----	-----	-----	-----	-----	-----	-----	-----	-----

- CONVERSION includes: (1) 21" x 7" round pipe, (1) adjustable collar, (1) white metal soffit grille (11 3/8" x 3 5/8"), (1) angle boot, (1) 7" x 6" reducer, filter, and installation instructions.
- CONVERSION is compatible with BLOWER250, BLOWER400, and BLOWER600.
- CONVERSION is not compatible with WHC30.
- FILTERCHAR is a replacement charcoal filter used to provide proper filtration for air recirculation when a conversion kit is used. The filter attaches to the inside of the removable mesh metal filter in the blower.

MODIFICATIONS

No modifications available for these products.

Price Point	1	2	3	4	5	6	7	8	9	10	11	12
-------------	---	---	---	---	---	---	---	---	---	----	----	----

HEARTH PIER, 9" WIDE, 36" HIGH

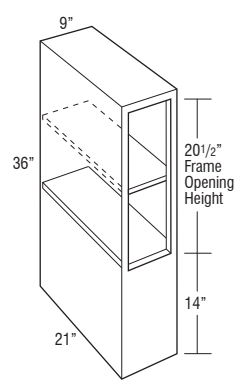

HP93621	977	977	977	977	977	977	977	977	977	977	977	977
----------------	-----	-----	-----	-----	-----	-----	-----	-----	-----	-----	-----	-----

- Designed for use with a floating hearth application.
- Not available in Rustic Hickory.
- Recommended for use with 24" high Mantel and 9" high Corbels.

Custom Modifications

ADDTK	AUTH	CBO	CCO	CFNTO	CFRMO	CH	CND	CW	EXBK	EX	FB	FFD	FPEB	ID	INVFRM	MIP	P	PFINBTMB	RD	TD	TVR_V	
		STD		•	•				•				STD	•		STD				•		

Construction Upgrades

APC	PE

Door Options

ALF	CG	CG.BTM	CG.TOP	DPSRR	MD	MD.BTM	MD.TOP	MFO

HEARTH MANTEL, 23 1/2" HIGH

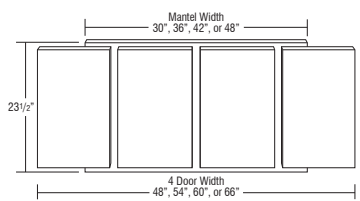

Model	Application
HM3023.5	48" Wide
HM3623.5	54" Wide
HM4223.5	60" Wide
HM4823.5	66" Wide

HM3023.5	1239	1327	1351	1373	1397	1419	1466	1505	1538	1559	1586	1688
HM3623.5	1286	1379	1406	1431	1457	1483	1536	1574	1611	1636	1661	1773
HM4223.5	1334	1437	1466	1495	1524	1553	1604	1650	1690	1718	1746	1864
HM4823.5	1537	1671	1708	1744	1781	1817	1886	1941	1987	2028	2066	2209

- Recommended for use with 36" high Hearth Piers and same width Raised or Recessed Panel Arched Valance.
- Not available in Rustic Hickory.
- Doors for Hearth Mantel are included. Field installation required for attachment of outer doors to Hearth Piers.

MODIFICATIONS

No modifications available for these products.

Door Options

ALF	CG	CG.BTM	CG.TOP	DPSRR	MD	MD.BTM	MD.TOP	MFO
				•				•

Finish Techniques

Heirlooming
•

HEARTH SHELF, 4 1/2" DEEP

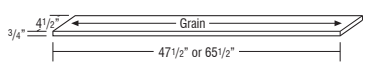

HS48	162	162	162	162	162	162	162	162	162	162	162	162
HS66	221	221	221	221	221	221	221	221	221	221	221	221

- Shelves will install on top of corbels and will slightly overlay the Raised or Recessed Panel Arched Valance.
- Shelf width should match the overall hearth width (pier width + Mantel/valance width).
- Actual shelf width is 1/2" shorter than the dimension in the product code.
- Shelf finished on one long edge, two short edges, top, and bottom.
- Not available in Rustic Hickory.
- If ordered with Heirlooming Technique, will not feature sand-through characteristics.

MODIFICATIONS

No modifications available for these products.

HEARTH LINER

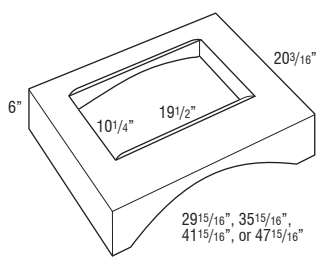

Model	Application
HL30	48" Wide
HL36	54" Wide
HL42	60" Wide
HL48	66" Wide

HL30	1195	1195	1195	1195	1195	1195	1195	1195	1195	1195	1195	1195
HL36	1207	1207	1207	1207	1207	1207	1207	1207	1207	1207	1207	1207
HL42	1225	1225	1225	1225	1225	1225	1225	1225	1225	1225	1225	1225
HL48	1241	1241	1241	1241	1241	1241	1241	1241	1241	1241	1241	1241

- Liner is metallic silver.
- Compatible with all blowers.
- Mounts to wall and adjoining cabinets.
- Recommended for use with Raised or Recessed Panel Arched Valance.

MODIFICATIONS

No modifications available for these products.

TABLE OF CONTENTS – BASE CABINETS

Base Cabinets with Drawers	113
Full Height Base Cabinets	115
Base Organization, Base with Roll Trays, and Specialty Cabinets	118
Sink Base Cabinets	128
Corner Base Cabinets	139
Drawer Base Cabinets	153
Wastebaskets	159
Pull-outs	162
Appliance Base Cabinets	165
Base Corner Peninsula Cabinets	168

BASE CABINETS

BASE CABINET NOMENCLATURE

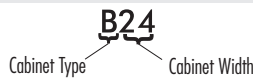

MODIFICATIONS GRID KEY

- Available
- STD Standard on these cabinets
-  5 Day Express Response Item

CONSTRUCTION UPGRADES

Mod.	Description
APC	All-plywood Construction
ET	EasyTrax™
PE	Plywood Ends

DOOR OPTIONS

Mod.	Description
DPSRR	Door Panel - Solid Reverse Raised

CUSTOM MODIFICATIONS

Mod.	Description	Mod.	Description
AUTHB	Authentic Ends - Both	FFDR	Face Frame and Door on End - Right
AUTHL	Authentic End - Left	FPEB	Furniture Finished Plywood Ends
AUTHR	Authentic End - Right	FTK	Flush Toekick
CBO	Cabinet Box Only	FTKAV	Flush Toekick Arch
CCO	Cabinet Case Only	FTKFV	Flush Toekick Furniture
CFNTO	Cabinet Front Only	ID	Increased Depth
CFP	Cabinet False Panel	INVFRM	Inverted Frame
CFRMO	Cabinet Frame Only	MIP	Matching Interior Plywood
CH	Custom Height	P	Peninsula
CMAT	CabMat™	PTOWB	Push to Open Wastebasket
CND	Cabinet with No Door, with Drawer	RD	Reduced Depth
CW	Custom Width	RECTKALL	Recessed Island Toekick
DRT	Deep Roll Tray	RECTKBK	Recessed Toekick - Back
DRWPWR	PowerGlide™ Compact Drawer Outlet	RECTKL	Recessed Toekick - Left
DRWSEC	Biometric Secured Drawer	RECTKR	Recessed Toekick - Right
DRWTK	Toekick Drawer	RT	Installed Roll Tray
DRWWRM	Warming Drawer	SCPDRW	Scooped Drawer
EXBKL	End Extended Back - Left	TD	Tray Dividers
EXBKR	End Extended Back - Right	TOTSSS	Tilt-out Tray, Stainless Steel Slim
EXL	Extended Stile - Left	TVRAV	Valance Top Rail, Arch
EXR	Extended Stile - Right	TVRFV	Valance Top Rail, Furniture
FB	Finished Ends	TVRVV	Valance Top Rail, Straight
FD	Full Depth Shelf	VTK	Void Toekick
FFDL	Face Frame and Door on End - Left		

All Base Cabinets are 34 1/2" high and 24" deep unless otherwise noted.

Base Cabinets are shipped with an unfinished toekick. Finished toekicks in matching wood veneer or laminate must be ordered separately and field installed.

Drawer box reduces in depth in 3" increments. Spacer blocks are used for drawer hardware.

FPEB modification is recommended for non-stacking applications. Use a 1/4" skin for stacking applications.

	Price Point	1	2	3	4	5	6	7	8	9	10	11	12
BASE SINGLE DOOR	B9 L or R	702	713	748	782	815	849	886	920	945	973	992	1062
	B12 L or R	781	820	831	842	853	864	912	942	977	1010	1037	1116
	B15 L or R	827	870	880	889	898	907	958	990	1026	1062	1086	1173
	B18 L or R	848	895	912	927	943	959	1011	1048	1084	1119	1149	1240
	B21 L or R	907	955	976	996	1016	1036	1093	1130	1172	1211	1240	1341
	B24 L or R	998	1046	1062	1077	1093	1109	1174	1214	1261	1303	1336	1444

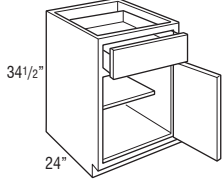

• Adjustable 15" deep shelf.

Custom Modifications

AUTH	CBO	CCO	CFNTO	CFP	CFRMO	CH	CMAT	CND	CW	DRT	DRWPWR	DRWSEC	DRWTK	DRWWRM	EXBK	EX	FB	FD	FFD	FPEB	FTK	FTK_V	ID	INVFRM	MIP	P	PTOWB	RD	RECTK	RT	SCPDRAW	TD	TOTSSS	TVR_V	VTK		
•	•	•	•	•	•	•	•	•	•	• ¹	•	• ²	• ²	• ²	•	•	•	•	•	•	•	•	• ³	•	•	• ¹	•	•	• ¹	•	•	•	•	•	•	•	•

Construction Upgrades

APC	ET	PE
•	•	•

Door Options

DPSRR
•

¹ Not available on 9" wide

² Not available on 9", 12", and 15" wide

³ Not available on 9" and 12" wide

BASE DOUBLE DOOR

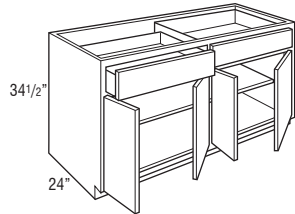
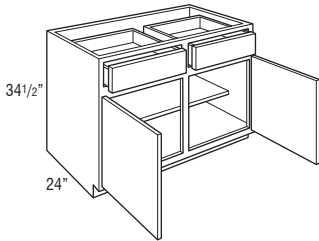
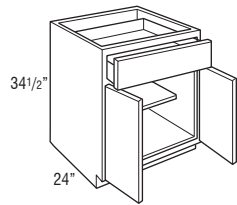

B24	1094	1136	1148	1160	1173	1185	1252	1299	1348	1392	1428	1542
B27	1140	1207	1240	1271	1304	1335	1412	1462	1518	1570	1608	1738
B30	1197	1271	1303	1334	1365	1396	1473	1528	1586	1639	1683	1819
B33	1213	1289	1328	1366	1406	1444	1525	1584	1642	1695	1742	1880
B36	1257	1334	1374	1413	1454	1493	1576	1636	1699	1754	1801	1950
B39	1512	1594	1612	1630	1648	1665	1754	1819	1884	1945	1995	2150
B42	1575	1656	1679	1701	1724	1746	1842	1912	1979	2044	2096	2260
B45	1636	1720	1748	1776	1804	1831	1932	2005	2076	2145	2199	2371
B48CS	1693	1781	1814	1848	1882	1914	2023	2097	2172	2243	2299	2482
B48	1810	1906	1951	1995	2038	2082	2200	2280	2364	2442	2503	2703

• Adjustable 15" deep shelf.

Custom Modifications

AUTH	CBO	CCO	CFNTO	CFP	CFRMO	CH	CMAT	CND	CW	DRT	DRWPWR	DRWSEC	DRWTK	DRWWRM	EXBK	EX	FB	FD	FFD	FPEB	FTK	FTK_V	ID	INVFRM	MIP	P	PTOWB	RD	RECTK	RT	SCPDRAW	TD	TOTSSS	TVR_V	VTK		
•	•	•	•	•	•	•	•	•	•	• ¹	•	• ²	• ³	•	•	•	•	•	•	•	•	•	•	•	•	•	•	•	•	•	•	•	•	•	•	•	•

Construction Upgrades

APC	ET	PE
•	•	•

Door Options

DPSRR
•

¹ Not available on 24" and 48" (4 doors) wide

² Available only on 24", 42", and 48" wide

³ Not available on 39", 42", 45", and 48" wide

BASE SINGLE DOOR with WOOD TIERED CUTLERY DIVIDER DRAWER

15", 18", 21", or 24"

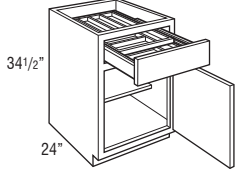

Price Point

	1	2	3	4	5	6	7	8	9	10	11	12
B15WTCD L or R	1305	1348	1358	1367	1376	1385	1436	1468	1504	1540	1564	1651
B18WTCD L or R	1344	1391	1408	1423	1439	1455	1507	1544	1580	1615	1645	1736
B21WTCD L or R	1422	1470	1491	1511	1531	1551	1608	1645	1687	1726	1755	1856
B24WTCD L or R	1530	1578	1594	1609	1625	1641	1706	1746	1793	1835	1868	1976

- Adjustable 15" deep shelf.
- Exterior WTCD drawer box height is 3 3/4", interior height of top and bottom tier is 1 3/8".
- Wood Tiered Cutlery Divider Drawer is also available as an accessory. See page 312.

Custom Modifications

AUTH	CBO	CCO	CFNTO	CFP	CFRMO	CH	CMAT	CND	CW	DRT	DRWPWR	DRWSEC	DRWTK	DRWWRM	EXBK	EX	FB	FD	FFD	FPEB	FTK	FTK_V	ID	INVFRM	MIP	P	PTOWB	RD	RECTK	RT	SCPDRW	TD	TOTSSS	TVR_V	VTK
•	•	•	•	•	•	•	•	•	•	•	•	•	• ¹	•	•	•	•	•	•	•	•	•	•	•	•	•	•	•	•	•	•	•	•	•	•

Construction Upgrades

APC	ET	PE
•	•	•

Door Options

DPSRR
•

¹ Not available on 15" wide

BASE DOUBLE DOOR with WOOD TIERED CUTLERY DIVIDER DRAWER

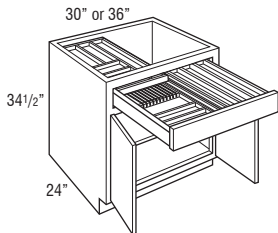
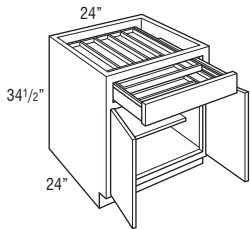

B24WTCD	1626	1668	1680	1692	1705	1717	1784	1831	1880	1924	1960	2074
B30WTCD	1892	1966	1998	2029	2060	2091	2168	2223	2281	2334	2378	2514
B36WTCD	1988	2065	2105	2144	2185	2224	2307	2367	2430	2485	2532	2681

- Adjustable 15" deep shelf.
- Exterior WTCD drawer box height is 3 3/4", interior height of top and bottom tier is 1 3/8".
- Wood Tiered Cutlery Divider Drawer is also available as an accessory. See page 312.

Custom Modifications

AUTH	CBO	CCO	CFNTO	CFP	CFRMO	CH	CMAT	CND	CW	DRT	DRWPWR	DRWSEC	DRWTK	DRWWRM	EXBK	EX	FB	FD	FFD	FPEB	FTK	FTK_V	ID	INVFRM	MIP	P	PTOWB	RD	RECTK	RT	SCPDRW	TD	TOTSSS	TVR_V	VTK
•	•	•	•	•	•	•	•	•	•	•	•	•	•	•	•	•	•	•	•	•	•	•	•	•	•	•	•	•	•	•	•	•	•	•	•

Construction Upgrades

APC	ET	PE
•	•	•

Door Options

DPSRR
•

FULL HEIGHT BASE SINGLE DOOR, 6" WIDE

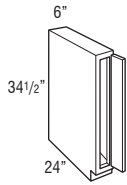

B6FH L or R	480	494	526	558	589	620	660	687	715	744	763	827
--------------------	-----	-----	-----	-----	-----	-----	-----	-----	-----	-----	-----	-----

- Frame opening is 3" wide.
- Cabinet has a full top panel.
- Utilizes a 5 1/2" wide overlay filler as a hinged door for full and partial overlay styles.
- When FFDL or FFDR modification is selected, the VTK modification will automatically be selected.

Custom Modifications

AUTH	CBO	CCO	CFNTO	CFP	CFRMO	CH	CMAT	CND	CW	DRT	DRWPWR	DRWSEC	DRWTK	DRWWRM	EXBK	EX	FB	FD	FFD	FPEB	FTK	FTK_V	ID	INVFRM	MIP	P	PTOWB	RD	RECTK	RT	SCPDRW	TD	TOTSSS	TVR_V	VTK	
•		•	•		•										•	•	•		• ¹	•	•			•	•		•									•

Construction Upgrades

APC	ET	PE
•		•

Door Options

DPSRR

¹ Includes VTK

FULL HEIGHT BASE SINGLE DOOR

9", 12", 15", 18", 21", or 24"

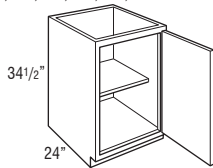

B9FH L or R	506	519	553	587	620	654	694	725	753	781	802	869
--------------------	-----	-----	-----	-----	-----	-----	-----	-----	-----	-----	-----	-----

B12FH L or R	525	558	591	625	659	692	732	760	794	821	846	914
---------------------	-----	-----	-----	-----	-----	-----	-----	-----	-----	-----	-----	-----

B15FH L or R	564	604	635	666	698	729	774	805	837	867	889	967
---------------------	-----	-----	-----	-----	-----	-----	-----	-----	-----	-----	-----	-----

B18FH L or R	590	625	663	700	738	775	824	855	887	922	945	1024
---------------------	-----	-----	-----	-----	-----	-----	-----	-----	-----	-----	-----	------

B21FH L or R	641	681	721	760	801	840	888	926	965	999	1026	1109
---------------------	-----	-----	-----	-----	-----	-----	-----	-----	-----	-----	------	------

B24FH L or R	787	833	858	883	907	931	987	1026	1070	1104	1137	1231
---------------------	-----	-----	-----	-----	-----	-----	-----	------	------	------	------	------

- Adjustable 15" deep shelf.

Custom Modifications

AUTH	CBO	CCO	CFNTO	CFP	CFRMO	CH	CMAT	CND	CW	DRT	DRWPWR	DRWSEC	DRWTK	DRWWRM	EXBK	EX	FB	FD	FFD	FPEB	FTK	FTK_V	ID	INVFRM	MIP	P	PTOWB	RD	RECTK	RT	SCPDRW	TD	TOTSSS	TVR_V	VTK
•	•	•	•	•	•					• ¹			• ²		•	•	•	•	•	•	•	• ³			•	•		•	•	• ¹					•

Construction Upgrades

APC	ET	PE
•		•

Door Options

DPSRR
•

¹ Not available on 9" wide

² Not available on 9", 12", and 15" wide

³ Not available on 9" and 12" wide

FULL HEIGHT BASE SINGLE DOOR, 40 1/2" HIGH

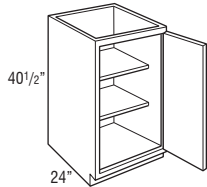

B1240FH L or R	1038	1080	1090	1100	1110	1119	1168	1204	1236	1266	1290	1373
-----------------------	------	------	------	------	------	------	------	------	------	------	------	------

B1540FH L or R	1083	1127	1136	1144	1152	1160	1214	1249	1286	1317	1342	1427
-----------------------	------	------	------	------	------	------	------	------	------	------	------	------

B1840FH L or R	1107	1155	1170	1185	1201	1215	1267	1305	1344	1375	1407	1499
-----------------------	------	------	------	------	------	------	------	------	------	------	------	------

B2140FH L or R	1165	1213	1233	1252	1271	1290	1347	1389	1431	1467	1499	1596
-----------------------	------	------	------	------	------	------	------	------	------	------	------	------

B2440FH L or R	1258	1303	1319	1335	1351	1366	1428	1476	1520	1558	1592	1698
-----------------------	------	------	------	------	------	------	------	------	------	------	------	------

- Two adjustable 15" deep shelves.

Custom Modifications

AUTH	CBO	CCO	CFNTO	CFP	CFRMO	CH	CMAT	CND	CW	DRT	DRWPWR	DRWSEC	DRWTK	DRWWRM	EXBK	EX	FB	FD	FFD	FPEB	FTK	FTK_V	ID	INVFRM	MIP	P	PTOWB	RD	RECTK	RT	SCPDRW	TD	TOTSSS	TVR_V	VTK	
•		•	•		•								• ¹		•	•	•	•	•	•	•	•	• ²			•	•		•	•						•

Construction Upgrades

APC	ET	PE
•		•

Door Options

DPSRR
•

¹ Not available on 12" and 15" wide

² Not available on 12" wide

FULL HEIGHT BASE DOUBLE DOOR

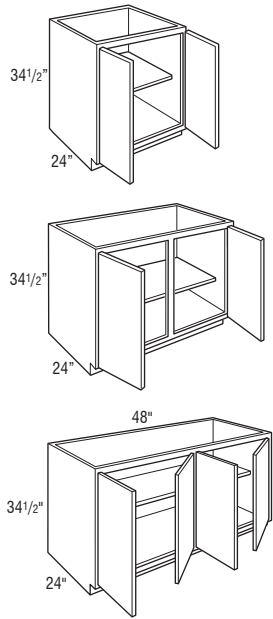

Price Point	1	2	3	4	5	6	7	8	9	10	11	12
B24FH	830	876	903	928	954	980	1040	1081	1124	1161	1196	1294
B27FH	851	906	959	1010	1063	1114	1184	1228	1276	1325	1359	1469
B30FH	908	963	1014	1064	1114	1164	1236	1288	1337	1384	1420	1540
B33FH	922	977	1035	1092	1150	1207	1285	1335	1389	1440	1475	1600
B36FH	962	1019	1077	1135	1193	1250	1326	1378	1432	1483	1525	1654
B39FH	1010	1072	1136	1198	1262	1325	1406	1460	1520	1574	1616	1748
B42FH	1063	1129	1197	1264	1332	1399	1482	1541	1604	1661	1710	1850
B45FH	1117	1186	1259	1331	1402	1474	1562	1625	1691	1752	1801	1951
B48FHCS	1168	1242	1319	1397	1474	1550	1642	1708	1776	1841	1894	2052
B48FH	1273	1354	1441	1528	1615	1701	1802	1877	1951	2019	2078	2249

• Adjustable 15" deep shelf.

Custom Modifications

AUTH	CBO	CCO	CFNTO	CFP	CFRMO	CH	CMAT	CND	CW	DRT	DRWPWR	DRWSEC	DRWTK	DRWWRM	EXBK	EX	FB	FD	FFD	FPEB	FTK	FTK_V	ID	INVFRM	MIP	P	PTOWB	RD	RECTK	RT	SCPDWR	TD	TOTSSS	TVR_V	VTK
•	•	•	•	•	•	•	•	•	• ¹	•	•	• ²	•	•	•	•	•	•	•	•	•	•	•	•	•	•	•	•	•	•	•	•	•	•	•

Construction Upgrades

APC	ET	PE
•	•	•

Door Options

DPSRR
•

¹ Not available on 24" and 48" (4 doors) wide
² Not available on 39", 42", 45", and 48" wide

FULL HEIGHT BASE DOUBLE DOOR, 40 1/2" HIGH

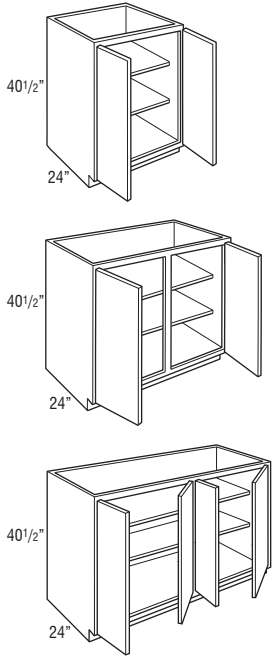

B2440FH	1352	1393	1407	1419	1431	1444	1508	1558	1607	1648	1686	1799
B2740FH	1398	1465	1496	1528	1559	1590	1668	1720	1775	1826	1865	1995
B3040FH	1458	1529	1559	1589	1620	1650	1730	1788	1844	1894	1939	2075
B3340FH	1475	1544	1584	1622	1660	1698	1781	1841	1900	1953	1997	2136
B3640FH	1516	1594	1632	1670	1708	1746	1833	1895	1957	2010	2059	2205
B3940FH	1770	1854	1872	1888	1906	1923	2010	2079	2141	2201	2251	2409
B4240FH	1835	1915	1938	1959	1981	2003	2100	2171	2238	2298	2351	2516
B4540FH	1895	1977	2005	2033	2061	2088	2188	2264	2337	2398	2454	2628
B4840FHCS	1952	2041	2073	2106	2138	2171	2276	2355	2433	2501	2555	2737
B4840FH	2070	2165	2209	2251	2295	2337	2455	2538	2624	2698	2759	2961

• Two adjustable 15" deep shelves.

Custom Modifications

AUTH	CBO	CCO	CFNTO	CFP	CFRMO	CH	CMAT	CND	CW	DRT	DRWPWR	DRWSEC	DRWTK	DRWWRM	EXBK	EX	FB	FD	FFD	FPEB	FTK	FTK_V	ID	INVFRM	MIP	P	PTOWB	RD	RECTK	RT	SCPDWR	TD	TOTSSS	TVR_V	VTK
•	•	•	•	•	•	•	•	•	• ¹	•	•	• ²	•	•	•	•	•	•	•	•	•	•	•	•	•	•	•	•	•	•	•	•	•	•	•

Construction Upgrades

APC	ET	PE
•	•	•

Door Options

DPSRR
•

¹ Not available on 24" and 48" (4 doors) wide
² Not available on 39", 42", 45", and 48" wide

	Price Point	1	2	3	4	5	6	7	8	9	10	11	12
WALL BASE SINGLE DOOR	WB12 L or R	525	558	591	625	659	692	732	760	794	821	846	914
	WB15 L or R	564	604	635	666	698	729	774	805	837	867	889	967
	WB18 L or R	590	625	663	700	738	775	824	855	887	922	945	1024
	WB21 L or R	641	681	721	760	801	840	888	926	965	999	1026	1109
	WB24 L or R	787	833	858	883	907	931	987	1026	1070	1104	1137	1231

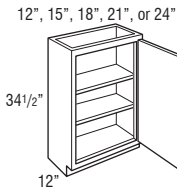

- Two full depth shelves.
- Will have the same shelf hole drill pattern as a base cabinet.

Custom Modifications

AUTH	CBO	CCO	CFNTO	CFP	CFRMO	CH	CMAT	CND	CW	DRT	DRWPWR	DRWSEC	DRWTK	DRWWRM	EXBK	EX	FB	FD	FFD	FPEB	FTK	FTK_V	ID	INVFRM	MIP	P	PTOWB	RD	RECTK	RT	SCDRW	TD	TOTSSS	TVR_V	VTK	
•	•	•	•	•	•	•	•	•	• ¹						•	•	•	•	•	•	•	• ²	•		•		•	• ³				•				•

Construction Upgrades

APC	ET	PE
•		•

Door Options

DPSRR
•

¹ Minimum width is 9"
² Not available on 12" wide
³ RECTKALL and RECTKBK not available

WALL BASE DOUBLE DOOR	WB24	830	876	903	928	954	980	1040	1081	1124	1161	1196	1294
	WB27	851	906	959	1010	1063	1114	1184	1228	1276	1325	1359	1469
	WB30	908	963	1014	1064	1114	1164	1236	1288	1337	1384	1420	1540
	WB33	922	977	1035	1092	1150	1207	1285	1335	1389	1440	1475	1600
	WB36	962	1019	1077	1135	1193	1250	1326	1378	1432	1483	1525	1654

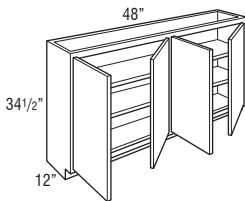
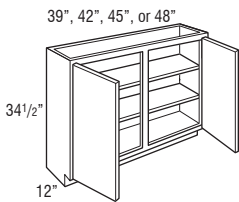
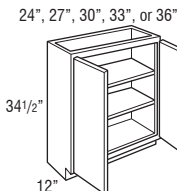

	WB39	1010	1072	1136	1198	1262	1325	1406	1460	1520	1574	1616	1748
	WB42	1063	1129	1197	1264	1332	1399	1482	1541	1604	1661	1710	1850
	WB45	1117	1186	1259	1331	1402	1474	1562	1625	1691	1752	1801	1951
	WB48CS	1168	1242	1319	1397	1474	1550	1642	1708	1776	1841	1894	2052
	WB48	1273	1354	1441	1528	1615	1701	1802	1877	1951	2019	2078	2249

- Two full depth shelves.
- Will have the same shelf hole drill pattern as a base cabinet.

Custom Modifications

AUTH	CBO	CCO	CFNTO	CFP	CFRMO	CH	CMAT	CND	CW	DRT	DRWPWR	DRWSEC	DRWTK	DRWWRM	EXBK	EX	FB	FD	FFD	FPEB	FTK	FTK_V	ID	INVFRM	MIP	P	PTOWB	RD	RECTK	RT	SCDRW	TD	TOTSSS	TVR_V	VTK	
•	•	•	•	•	•	•	•	•	• ¹						•	•	•	•	•	•	•	•	•	•	•	•	•	• ²				• ³				•

Construction Upgrades

APC	ET	PE
•		•

Door Options

DPSRR
•

¹ Not available on 24" and 48" (4 doors) wide
² RECTKALL and RECTKBK not available
³ Not available on 39", 42", 45", and 48" wide

Price Point

1 2 3 4 5 6 7 8 9 10 11 12

30" SUPERCABINET™

BSC30RP	1796	1851	1902	1952	2002	2052	2124	2176	2225	2272	2308	2428
BSC30PR	1796	1851	1902	1952	2002	2052	2124	2176	2225	2272	2308	2428
BSC30RS	1405	1460	1511	1561	1611	1661	1733	1785	1834	1881	1917	2037
BSC30SR	1405	1460	1511	1561	1611	1661	1733	1785	1834	1881	1917	2037
BSC30R	1360	1415	1466	1516	1566	1616	1688	1740	1789	1836	1872	1992

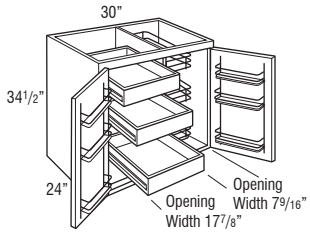

BSC30RP

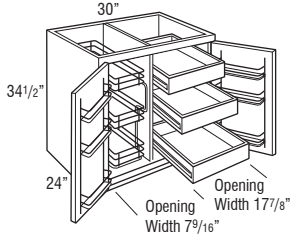

BSC30PR

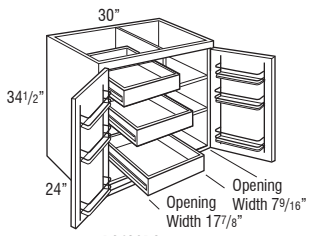

BSC30RS

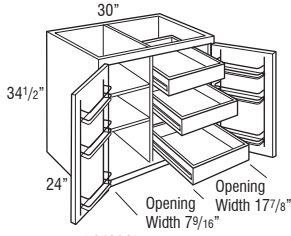

BSC30SR

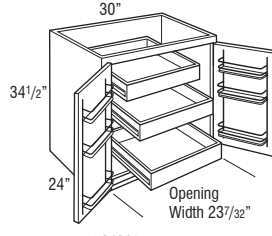

BSC30R

- Nomenclature represents left to right order of interior components.
Example: BSC30RP = Base SuperCabinet™ 30" Roll-out Pull-out.
- Shelves are adjustable and 20" deep.
- Cabinets utilize 170° hinge. For sufficient pull-out clearance, 12" of adjacent space is required for door to open 170° when installed near a wall or corner.
- Each door features a chrome and wood three-tiered rack.
- Door rack width is 9 3/8".
- Door rack depth is 3".
- Integrated soft-close hinge not included. Premium door mechanism installed.

Custom Modifications

AUTH	CBO	CCO	CFNTO	CFP	CFRMO	CH	CMAT	CND	CW	DRT	DRWPWR	DRWSEC	DRWTK	DRWWRM	EXBK	EX	FB	FD	FFD	FPEB	FTK	FTK_V	ID	INVFRM	MIP	P	PTOWB	RD	RECTK	RT	SCPDRW	TD	TOTSSS	TVR_V	VTK
•	•	•	•	•	•	•	•	•	•	•	•	•	•	•	•	•	•	•	•	•	•	•	•	•	•	•	•	•	•	•	•	•	•	•	•

Construction Upgrades

APC	ET	PE
•	•	•

Door Options

DPSRR
•

36" SUPERCABINET™

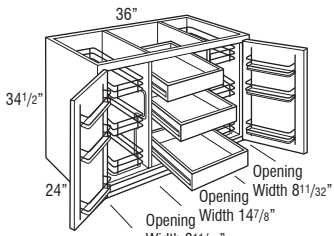

BSC36PRP

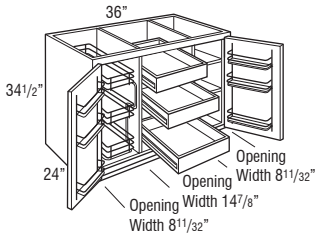

BSC36PRS

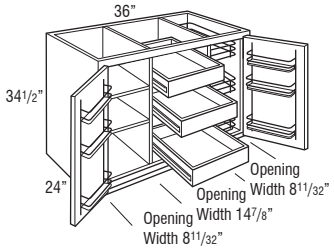

BSC36SRP

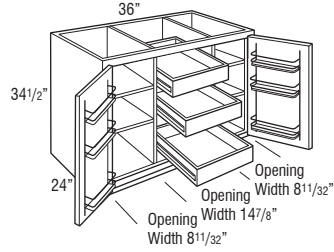

BSC36SRS

Price Point	1	2	3	4	5	6	7	8	9	10	11	12
BSC36PRP	2342	2399	2457	2515	2573	2630	2706	2758	2812	2863	2905	3034
BSC36PRS	1981	2038	2096	2154	2212	2269	2345	2397	2451	2502	2544	2673
BSC36SRP	1981	2038	2096	2154	2212	2269	2345	2397	2451	2502	2544	2673
BSC36SRS	1587	1644	1702	1760	1818	1875	1951	2003	2057	2108	2150	2279

- Nomenclature represents left to right order of interior components.
Example: BSC36PRP = Base SuperCabinet™ 36" Pull-out Roll-out Pull-out.
- Shelves are adjustable and 20" deep.
- Cabinets utilize 170° hinge. For sufficient pull-out clearance, 12" of adjacent space is required for door to open 170° when installed near a wall or corner.
- Each door features a chrome and wood three-tiered rack.
- Door rack width is 12 3/8".
- Door rack depth is 3".
- Integrated soft-close hinge not included. Premium door mechanism installed.

Custom Modifications

AUTH	CBO	CCO	CFNTO	CFP	CFRMO	CH	CMTAT	CND	CW	DRT	DRWPWR	DRWSEC	DRWTK	DRWWRM	EXBK	EX	FB	FD	FFD	FPEB	FTK	FTK_V	ID	INVFRM	MIP	P	PTOWB	RD	RECTK	RT	SCDRW	TD	TOTSSS	TVR_V	VTK	
•	•	•	•	•	•	•	•	•	•	•	•	•	•	•	•	•	•	•	•	•	•	•	•	•	•	•	•	•	•	•	•	•	•	•	•	•

Construction Upgrades

APC	ET	PE
•	•	•

Door Options

DPSRR
•

Price Point

BASE with ROLL TRAYS

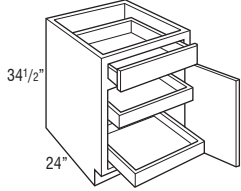

	1	2	3	4	5	6	7	8	9	10	11	12
B12RT L or R	1342	1381	1392	1403	1414	1425	1473	1503	1538	1571	1598	1677
B15RT L or R	1388	1431	1441	1450	1459	1468	1519	1551	1587	1623	1647	1734
B18RT L or R	1409	1456	1473	1488	1504	1520	1572	1609	1645	1680	1710	1801
B21RT L or R	1468	1516	1537	1557	1577	1597	1654	1691	1733	1772	1801	1902
B24RT L or R	1559	1607	1623	1638	1654	1670	1735	1775	1822	1864	1897	2005

- 2 roll trays standard.
- Cabinet may accommodate up to 4 roll trays, which may be purchased separately for field installation. See page 317.

Custom Modifications

AUTH	CBO	CCO	CFNTO	CFP	CFRMO	CH	CMAT	CND	CW	DRT	DRWPWR	DRWSEC	DRWTK	DRWWRM	EXBK	EX	FB	FD	FFD	FPEB	FTK	FTK V	ID	INVFRM	MIP	P	PTOWB	RD	RECTK	RT	SCPDRW	TD	TOTSSS	TVR	V	VTK
•	•	•	•	•	•	•	•	•	•	• ¹	•	• ²	• ²	• ²	•	•	•	•	•	•	•	•	• ¹	•	•	•	•	•	•	•	•	•	•	•	•	•

Construction Upgrades

APC	ET	PE
•	•	•

Door Options

DPSRR
•

¹ Not available on 12" wide
² Not available on 12" and 15" wide

BASE DOUBLE DOOR with ROLL TRAYS

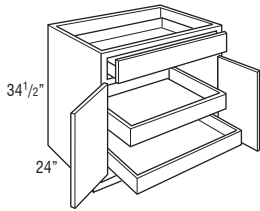

B24RT	1655	1697	1709	1721	1734	1746	1813	1860	1909	1953	1989	2103
B27RT	1701	1768	1801	1832	1865	1896	1973	2023	2079	2131	2169	2299
B30RT	1758	1832	1864	1895	1926	1957	2034	2089	2147	2200	2244	2380
B33RT	1774	1850	1889	1927	1967	2005	2086	2145	2203	2256	2303	2441
B36RT	1818	1895	1935	1974	2015	2054	2137	2197	2260	2315	2362	2511

- 2 roll trays standard.
- Cabinet may accommodate up to 4 roll trays, which may be purchased separately for field installation. See page 317.

Custom Modifications

AUTH	CBO	CCO	CFNTO	CFP	CFRMO	CH	CMAT	CND	CW	DRT	DRWPWR	DRWSEC	DRWTK	DRWWRM	EXBK	EX	FB	FD	FFD	FPEB	FTK	FTK V	ID	INVFRM	MIP	P	PTOWB	RD	RECTK	RT	SCPDRW	TD	TOTSSS	TVR	V	VTK	
•	•	•	•	•	•	•	•	•	•	• ¹	•	• ²	•	•	•	•	•	•	•	•	•	•	•	•	•	•	•	•	•	•	•	•	•	•	•	•	•

Construction Upgrades

APC	ET	PE
•	•	•

Door Options

DPSRR
•

¹ Not available on 24" wide
² Available only on 24" wide

BASE DOUBLE DOOR with ROLL TRAYS

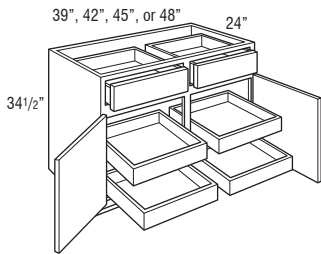

B39RT	2634	2716	2734	2752	2770	2787	2876	2941	3006	3067	3117	3272
B42RT	2697	2778	2801	2823	2846	2868	2964	3034	3101	3166	3218	3382
B45RT	2758	2842	2870	2898	2926	2953	3054	3127	3198	3267	3321	3493
B48CSRT	2815	2903	2936	2970	3004	3036	3145	3219	3294	3365	3421	3604

B48RT	2932	3028	3073	3117	3160	3204	3322	3402	3486	3564	3625	3825
--------------	------	------	------	------	------	------	------	------	------	------	------	------

- 4 roll trays standard.
- Cabinet may accommodate up to 8 roll trays, which may be purchased separately for field installation. See page 317.

Custom Modifications

AUTH	CBO	CCO	CFNTO	CFP	CFRMO	CH	CMAT	CND	CW	DRT	DRWPWR	DRWSEC	DRWTK	DRWWRM	EXBK	EX	FB	FD	FFD	FPEB	FTK	FTK V	ID	INVFRM	MIP	P	PTOWB	RD	RECTK	RT	SCPDRW	TD	TOTSSS	TVR	V	VTK
•	•	•	•	•	•	•	•	•	•	• ¹	•	• ²	•	•	•	•	•	•	•	•	•	•	•	•	•	•	•	•	•	•	•	•	•	•	•	•

Construction Upgrades

APC	ET	PE
•	•	•

Door Options

DPSRR
•

¹ Not available on 48" (4 doors) wide
² Available only on 42" and 48" wide

Price Point

	1	2	3	4	5	6	7	8	9	10	11	12
BASE FULL HEIGHT with ROLL TRAYS												
B12FHRT L or R	1086	1119	1152	1186	1220	1253	1293	1321	1355	1382	1407	1475
B15FHRT L or R	1125	1165	1196	1227	1259	1290	1335	1366	1398	1428	1450	1528
B18FHRT L or R	1151	1186	1224	1261	1299	1336	1385	1416	1448	1483	1506	1585
B21FHRT L or R	1202	1242	1282	1321	1362	1401	1449	1487	1526	1560	1587	1670
B24FHRT L or R	1348	1394	1419	1444	1468	1492	1548	1587	1631	1665	1698	1792

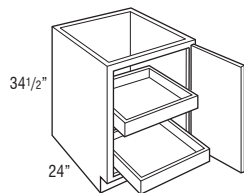

- 2 roll trays standard.
- Cabinet may accommodate up to 5 roll trays, which may be purchased separately for field installation. See page 317.

Custom Modifications

AUTH	CBO	CCO	CFNTO	CFP	CFRMO	CH	CMAT	CND	CW	DRT	DRWPWR	DRWSEC	DRWTK	DRWWRM	EXBK	EX	FB	FD	FFD	FPEB	FTK	FTK_V	ID	INVFRM	MIP	P	PTOWB	RD	RECTK	RT	SCPDW	TD	TOTSSS	TVR_V	VTK		
•	•	•	•	•	•	•	•	•	•	1	•	•	•	•	•	•	•	•	•	•	•	•	•	•	•	•	•	•	•	•	•	•	•	•	•	•	•

Construction Upgrades

APC	ET	PE
•	•	•

Door Options

DPSRR
•

¹ Not available on 12" wide
² Not available on 12" and 15" wide

	1	2	3	4	5	6	7	8	9	10	11	12
BASE FULL HEIGHT with ROLL TRAYS												
B24FHRT	1391	1437	1464	1489	1515	1541	1601	1642	1685	1722	1757	1855
B27FHRT	1412	1467	1520	1571	1624	1675	1745	1789	1837	1886	1920	2030
B30FHRT	1469	1524	1575	1625	1675	1725	1797	1849	1898	1945	1981	2101
B33FHRT	1483	1538	1596	1653	1711	1768	1846	1896	1950	2001	2036	2161
B36FHRT	1523	1580	1638	1696	1754	1811	1887	1939	1993	2044	2086	2215

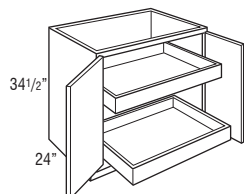

- 2 roll trays standard.
- Cabinet may accommodate up to 5 roll trays, which may be purchased separately for field installation. See page 317.

Custom Modifications

AUTH	CBO	CCO	CFNTO	CFP	CFRMO	CH	CMAT	CND	CW	DRT	DRWPWR	DRWSEC	DRWTK	DRWWRM	EXBK	EX	FB	FD	FFD	FPEB	FTK	FTK_V	ID	INVFRM	MIP	P	PTOWB	RD	RECTK	RT	SCPDW	TD	TOTSSS	TVR_V	VTK		
•	•	•	•	•	•	•	•	•	•	1	•	•	•	•	•	•	•	•	•	•	•	•	•	•	•	•	•	•	•	•	•	•	•	•	•	•	•

Construction Upgrades

APC	ET	PE
•	•	•

Door Options

DPSRR
•

¹ Not available on 24" wide

	1	2	3	4	5	6	7	8	9	10	11	12
BASE FULL HEIGHT DOUBLE DOOR with ROLL TRAYS												
B39FHRT	2132	2194	2258	2320	2384	2447	2528	2582	2642	2696	2738	2870
B42FHRT	2185	2251	2319	2386	2454	2521	2604	2663	2726	2783	2832	2972
B45FHRT	2239	2308	2381	2453	2524	2596	2684	2747	2813	2874	2923	3073
B48FHCSRT	2290	2364	2441	2519	2596	2672	2764	2830	2898	2963	3016	3174

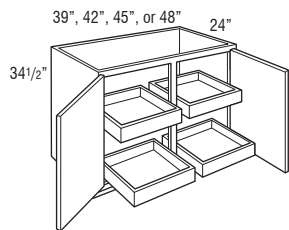

- 4 roll trays standard.
- Cabinet may accommodate up to 10 roll trays, which may be purchased separately for field installation. See page 317.

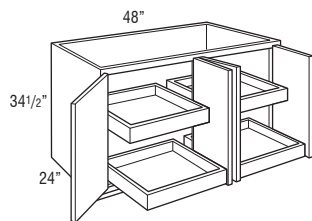

Custom Modifications

AUTH	CBO	CCO	CFNTO	CFP	CFRMO	CH	CMAT	CND	CW	DRT	DRWPWR	DRWSEC	DRWTK	DRWWRM	EXBK	EX	FB	FD	FFD	FPEB	FTK	FTK_V	ID	INVFRM	MIP	P	PTOWB	RD	RECTK	RT	SCPDW	TD	TOTSSS	TVR_V	VTK		
•	•	•	•	•	•	•	•	•	•	1	•	•	•	•	•	•	•	•	•	•	•	•	•	•	•	•	•	•	•	•	•	•	•	•	•	•	•

Construction Upgrades

APC	ET	PE
•	•	•

Door Options

DPSRR
•

¹ Not available on 48" (4 doors) wide

Price Point

BASE SINGLE DOOR with WOOD TIERED CUTLERY DIVIDER DRAWER and ROLL TRAYS

15", 18", 21", or 24"

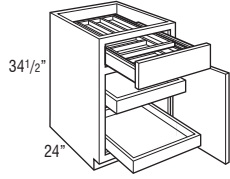

	1	2	3	4	5	6	7	8	9	10	11	12
B15RTWTCD L or R	1866	1909	1919	1928	1937	1946	1997	2029	2065	2101	2125	2212
B18RTWTCD L or R	1905	1952	1969	1984	2000	2016	2068	2105	2141	2176	2206	2297
B21RTWTCD L or R	1983	2031	2052	2072	2092	2112	2169	2206	2248	2287	2316	2417
B24RTWTCD L or R	2091	2139	2155	2170	2186	2202	2267	2307	2354	2396	2429	2537

- 2 roll trays standard.
- Cabinet may accommodate up to 4 roll trays, which may be purchased separately for field installation. See page 317.
- Exterior WTCD drawer box height is 3 3/4", interior height of top and bottom tier is 1 3/8".
- Wood Tiered Cutlery Divider Drawer is also available as an accessory. See page 312.

Custom Modifications

AUTH	CBO	CCO	CFNT0	CFP	CFRMO	CH	CMAT	CND	CW	DRT	DRWPWR	DRWSEC	DRWTK	DRWWRM	EXBK	EX	FB	FD	FFD	FPEB	FTK	FTK_V	ID	INVFRM	MIP	P	PTOWB	RD	RECTK	RT	SCPDRW	TD	TOTSSS	TVR_V	VTK
•	•	•	•	•	•	•	•	•	•	•	•	•	• ¹	•	•	•	•	•	•	•	•	•	•	•	•	•	•	•	•	•	•	•	•	•	•

Construction Upgrades

APC	ET	PE
•	•	•

Door Options

DPSRR
•

¹ Not available on 15" wide

BASE DOUBLE DOOR with WOOD TIERED CUTLERY DIVIDER DRAWER and ROLL TRAYS

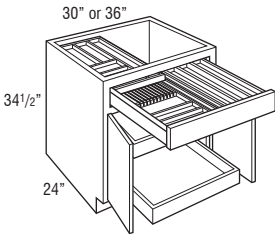
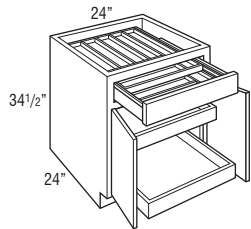

B24RTWTCD	2187	2229	2241	2253	2266	2278	2345	2392	2441	2485	2521	2635
B30RTWTCD	2453	2527	2559	2590	2621	2652	2729	2784	2842	2895	2939	3075
B36RTWTCD	2549	2626	2666	2705	2746	2785	2868	2928	2991	3046	3093	3242

- 2 roll trays standard.
- Cabinet may accommodate up to 4 roll trays, which may be purchased separately for field installation. See page 317.
- Exterior WTCD drawer box height is 3 3/4", interior height of top and bottom tier is 1 3/8".
- Wood Tiered Cutlery Divider Drawer is also available as an accessory. See page 312.

Custom Modifications

AUTH	CBO	CCO	CFNT0	CFP	CFRMO	CH	CMAT	CND	CW	DRT	DRWPWR	DRWSEC	DRWTK	DRWWRM	EXBK	EX	FB	FD	FFD	FPEB	FTK	FTK_V	ID	INVFRM	MIP	P	PTOWB	RD	RECTK	RT	SCPDRW	TD	TOTSSS	TVR_V	VTK
•	•	•	•	•	•	•	•	•	•	•	•	•	•	•	•	•	•	•	•	•	•	•	•	•	•	•	•	•	•	•	•	•	•	•	•

Construction Upgrades

APC	ET	PE
•	•	•

Door Options

DPSRR
•

POTS & PANS ORGANIZER BASE with DRAWER

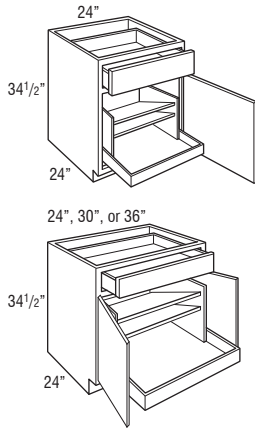

	Price Point	1	2	3	4	5	6	7	8	9	10	11	12
B24PS L or R		1448	1496	1512	1527	1543	1559	1624	1664	1711	1753	1786	1894
B24PS		1682	1724	1736	1748	1761	1773	1840	1887	1936	1980	2016	2130
B30PS		1821	1895	1927	1958	1989	2020	2097	2152	2210	2263	2307	2443
B36PS		1953	2030	2070	2109	2150	2189	2272	2332	2395	2450	2497	2646

- Cabinet has bottom roll tray with double lid storage shelves above.
- Base Pan Storage unit is also available as an accessory for field installation. See page 311.

Custom Modifications

AUTH	CBO	CCO	CFNTO	CFP	CFRMO	CH	CMAT	CND	CW	DRT	DRWPWR	DRWSEC	DRWTK	DRWWRM	EXBK	EX	FB	FD	FFD	FPEB	FTK	FTK_V	ID	INVFRM	MIP	P	PTOWB	RD	RECTK	RT	SCDRW	TD	TOTSSS	TVR_V	VTK	
•	•	•	•	•	•	•	•	•	•	•	•	• ¹	•	•	•	•	•	•	•	•	•	•	•	•	•	•	•	•	•	•	•	•	•	•	•	•

Construction Upgrades

APC	ET	PE
•	•	•

Door Options

DPSRR
•

¹ Available only on 24" wide

BASE POTS & PANS PULL-OUT

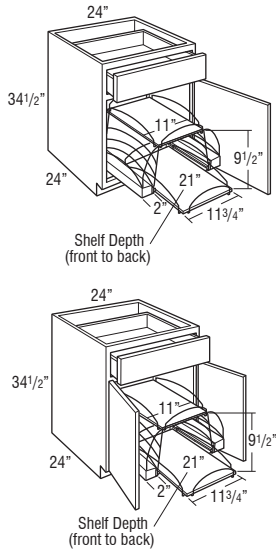

	1	2	3	4	5	6	7	8	9	10	11	12
BPPP24 L or R	1643	1691	1707	1722	1738	1754	1819	1859	1906	1948	1981	2089
BPPP24	2083	2125	2137	2149	2162	2174	2241	2288	2337	2381	2417	2531

- Full Extension slide-out shelves pull out independently.
- Pots and Pans Pull-out is also available as an accessory for field installation. See page 314.
- For full access from both sides of unit, do not install against a wall or next to deeper appliances and cabinets.

Custom Modifications

AUTH	CBO	CCO	CFNTO	CFP	CFRMO	CH	CMAT	CND	CW	DRT	DRWPWR	DRWSEC	DRWTK	DRWWRM	EXBK	EX	FB	FD	FFD	FPEB	FTK	FTK_V	ID	INVFRM	MIP	P	PTOWB	RD	RECTK	RT	SCDRW	TD	TOTSSS	TVR_V	VTK
•	•	•	•	•	•	•	•	•	•	•	•	•	•	•	•	•	•	•	•	•	•	•	•	•	•	•	•	•	•	•	•	•	•	•	•

Construction Upgrades

APC	ET	PE
•	•	•

Door Options

DPSRR
•

BASE POTS & PANS PULL-OUT

BPPP30

2568	2642	2674	2705	2736	2767	2844	2899	2957	3010	3054	3190
------	------	------	------	------	------	------	------	------	------	------	------

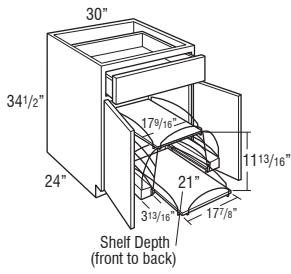

- Full Extension slide-out shelves pull out independently.
- Pots and Pans Pull-out is also available as an accessory for field installation. See page 314.
- For full access from both sides of unit, do not install against a wall or next to deeper appliances and cabinets.

Custom Modifications

AUTH	CBO	CCO	CFNTO	CFP	CFRMO	CH	CMAT	CND	CW	DRT	DRWPWR	DRWSEC	DRWTK	DRWWRM	EXBK	EX	FB	FD	FFD	FPEB	FTK	FTK_V	ID	INVFRM	MIP	P	PTOWB	RD	RECTK	RT	SCPDWR	TD	TOTSSS	TVR_V	VTK		
•	•	•	•	•	•	•	•	•	•	•	•	•	•	•	•	•	•	•	•	•	•	•	•	•	•	•	•	•	•	•	•	•	•	•	•	•	•

Construction Upgrades

APC	ET	PE
•	•	•

Door Options

DPSRR
•

BASE with FOOD STORAGE CONTAINER ORGANIZER

B18FSCO L or R

2229	2276	2293	2308	2324	2340	2392	2429	2465	2500	2530	2621
------	------	------	------	------	------	------	------	------	------	------	------

B24FSCO L or R

2379	2427	2443	2458	2474	2490	2555	2595	2642	2684	2717	2825
------	------	------	------	------	------	------	------	------	------	------	------

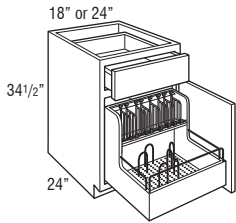

- Pull-out features natural finished hardwood dovetailed box with chrome rails on lower section with undermount soft-close guides.
- Includes seven chrome "U" pegs to use on the pegboard bottom to customize the fit to container sizes.
- Adjustable clip-on lid dividers included to fit with a variety of lid shapes. 18" wide includes five dividers, 24" wide includes eight dividers.
- Front of pull-out is routed for easy access.

Custom Modifications

AUTH	CBO	CCO	CFNTO	CFP	CFRMO	CH	CMAT	CND	CW	DRT	DRWPWR	DRWSEC	DRWTK	DRWWRM	EXBK	EX	FB	FD	FFD	FPEB	FTK	FTK_V	ID	INVFRM	MIP	P	PTOWB	RD	RECTK	RT	SCPDWR	TD	TOTSSS	TVR_V	VTK		
•	•	•	•	•	•	•	•	•	•	•	•	•	•	•	•	•	•	•	•	•	•	•	•	•	•	•	•	•	•	•	•	•	•	•	•	•	•

Construction Upgrades

APC	ET	PE
•	•	•

Door Options

DPSRR
•

Price
Point

1

2

3

4

5

6

7

8

9

10

11

12

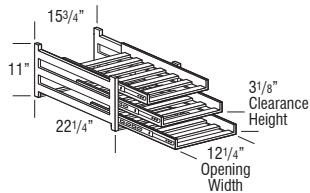
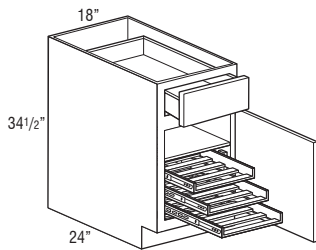
BASE with CAN and WINE BOTTLE PULL-OUTS**B18CWP18 L or R**

3141

3188

3205

3220

3236

3252

3304

3341

3377

3412

3442

3533

- Pull-outs feature natural finished hardwood with side-mounted guides (soft-close not included).
- One adjustable full depth shelf.
- Holds eighteen wine bottles.
- Insert not available as a field installed kit.

Custom Modifications

AUTH	CBO	CCO	CFNTO	CFP	CFRMO	CH	CMAT	CND	CW	DRT	DRWPWR	DRWSEC	DRWTK	DRWWRM	EXBK	EX	FB	FD	FFD	FPEB	FTK	FTK_V	ID	INVERM	MIP	P	PTOWB	RD	RECTK	RT	SCPDRW	TD	TOTSSS	TVR_V	VTK		
•	•	•	•	•	•	•	•	•	•	•	•	•	•	•	•	•	•	•	•	•	•	•	•	•	•	•	•	•	•	•	•	•	•	•	•	•	•

Construction Upgrades

APC	ET	PE
•	•	•

Door Options

DPSRR
•

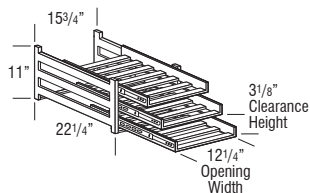
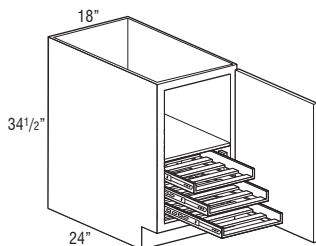
BASE FULL HEIGHT with CAN and WINE BOTTLE PULL-OUTS**B18FHCWP18 L or R**

2883

2918

2956

2993

3031

3068

3117

3148

3180

3215

3238

3317

- Pull-outs feature natural finished hardwood with side-mounted guides (soft-close not included).
- One adjustable full depth shelf.
- Holds eighteen wine bottles.
- Insert not available as a field installed kit.

Custom Modifications

AUTH	CBO	CCO	CFNTO	CFP	CFRMO	CH	CMAT	CND	CW	DRT	DRWPWR	DRWSEC	DRWTK	DRWWRM	EXBK	EX	FB	FD	FFD	FPEB	FTK	FTK_V	ID	INVERM	MIP	P	PTOWB	RD	RECTK	RT	SCPDRW	TD	TOTSSS	TVR_V	VTK		
•	•	•	•	•	•	•	•	•	•	•	•	•	•	•	•	•	•	•	•	•	•	•	•	•	•	•	•	•	•	•	•	•	•	•	•	•	•

Construction Upgrades

APC	ET	PE
•	•	•

Door Options

DPSRR
•

125

BASE CABINETS

Price Point

	1	2	3	4	5	6	7	8	9	10	11	12
BASE with ROLL-OUT TRAY DIVIDER												
B12TDRO L or R	1164	1203	1214	1225	1236	1247	1295	1325	1360	1393	1420	1499

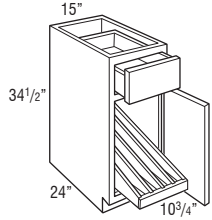
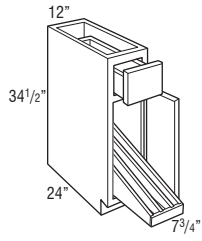

B15TDRO L or R	1244	1287	1297	1306	1315	1324	1375	1407	1443	1479	1503	1590
-----------------------	------	------	------	------	------	------	------	------	------	------	------	------

- Dividers are removable.
- 12" - 3 compartments.
- 15" - 4 compartments.
- Roll-out Tray Divider is also available as an accessory for field installation. See page 316.
- Tray divider utilizes soft-close undermount guides.

Custom Modifications

AUTH	CBO	CCO	CFNTO	CFP	CFRMO	CH	CMAT	CND	CW	DRT	DRWPWR	DRWSEC	DRWTK	DRWWRM	EXBK	EX	FB	FD	FFD	FPEB	FTK	FTK_V	ID	INVFRM	MIP	P	PTOWB	RD	RECTK	RT	SCPDRW	TD	TOTSSS	TVR_V	VTK	
•	•	•	•	•	•	•	•	•	•	•	•	•	•	•	•	•	•	•	•	•	•	•	•	•	•	•	•	•	•	•	•	•	•	•	•	•

Construction Upgrades

APC	ET	PE
•	•	•

Door Options

DPSRR
•

¹ Not available on 12" wide

BASE with TRAY DIVIDER												
TD9 L or R	831	860	870	879	889	898	944	979	1019	1047	1074	1159

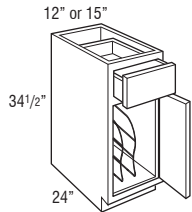
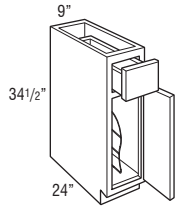

TD12 L or R	884	912	923	933	944	954	1007	1040	1079	1113	1142	1232
--------------------	-----	-----	-----	-----	-----	-----	------	------	------	------	------	------

TD15 L or R	935	964	976	986	997	1007	1058	1098	1136	1173	1202	1296
--------------------	-----	-----	-----	-----	-----	------	------	------	------	------	------	------

- Tray Divider is chrome.
- Tray Divider is also available as an accessory for field installation. See page 315.
- Dividers are removable for easy cleaning.

Custom Modifications

AUTH	CBO	CCO	CFNTO	CFP	CFRMO	CH	CMAT	CND	CW	DRT	DRWPWR	DRWSEC	DRWTK	DRWWRM	EXBK	EX	FB	FD	FFD	FPEB	FTK	FTK_V	ID	INVFRM	MIP	P	PTOWB	RD	RECTK	RT	SCPDRW	TD	TOTSSS	TVR_V	VTK	
•	•	•	•	•	•	•	•	•	•	•	•	•	•	•	•	•	•	•	•	•	•	•	•	•	•	•	•	•	•	•	•	•	•	•	•	•

Construction Upgrades

APC	ET	PE
•	•	•

Door Options

DPSRR
•

¹ Not available on 9" and 12" wide

² RECTKALL not available on 9" wide

BASE FULL HEIGHT with TRAY DIVIDER

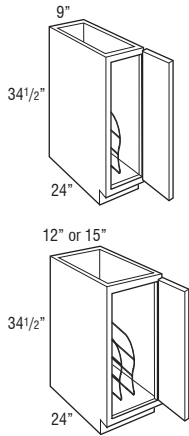

	Price Point	1	2	3	4	5	6	7	8	9	10	11	12
TD9FH L or R		687	718	728	737	747	756	804	837	874	909	932	1019
TD12FH L or R		741	769	780	790	800	810	864	896	935	972	1001	1092
TD15FH L or R		792	820	831	842	853	864	916	954	991	1032	1062	1156

- Tray Divider is chrome.
- Tray Divider is also available as an accessory for field installation. See page 315.
- Dividers are removable for easy cleaning.

Custom Modifications

AUTH	CBO	CCO	CFNTO	CFP	CFRMO	CH	CMAT	CND	CW	DRT	DRWPWR	DRWSEC	DRWTK	DRWWRM	EXBK	EX	FB	FD	FFD	FPEB	FTK	FTK_V	ID	INVFRM	MIP	P	PTOWB	RD	RECTK	RT	SCPDRW	TD	TOTSSS	TVR_V	VTK	
•	•	•	•	•	•										•	•	•			•	•	•	• ¹			•			• ²							•

Construction Upgrades

APC	ET	PE
•		•

Door Options

DPSRR
•

¹ Not available on 9" and 12" wide
² RECTKALL not available on 9" wide

BASE CABINET with MIXER SHELF

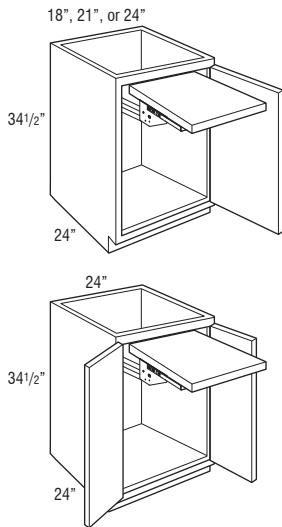

B18FHMIXSC L or R	1747	1782	1820	1857	1895	1932	1981	2012	2044	2079	2102	2181
B21FHMIXSC L or R	1926	1966	2006	2045	2086	2125	2173	2211	2250	2284	2311	2394
B24FHMIXSC L or R	2200	2246	2271	2296	2320	2344	2400	2439	2483	2517	2550	2644
B24FHMIXSC	2243	2289	2316	2341	2367	2393	2453	2494	2537	2574	2609	2707

- Includes mixer lift with soft-close closing feature.
- Mixer shelf will be 3/4" thick, mixer shelf dimensions:
 18" wide: 11 3/4" wide x 20" deep.
 21" wide: 14 3/4" wide x 20" deep.
 24" wide: 17 3/4" wide x 20" deep.
- Maximum Weight Capacity for Mixer Shelf: 60 lbs.
- Mixer shelf locks in the fully open position. Release brackets lower the mixer shelf back into the cabinet.
- When in closed position, clearance above shelf is 17 5/8"; clearance below shelf is 7 3/4".
- Mixer shelves are also available as an accessory for field installation. See page 311.

Custom Modifications

AUTH	CBO	CCO	CFNTO	CFP	CFRMO	CH	CMAT	CND	CW	DRT	DRWPWR	DRWSEC	DRWTK	DRWWRM	EXBK	EX	FB	FD	FFD	FPEB	FTK	FTK_V	ID	INVFRM	MIP	P	PTOWB	RD	RECTK	RT	SCPDRW	TD	TOTSSS	TVR_V	VTK	
•	•	•	•	•	•									•	•	•			•	•	•	•						•								•

Construction Upgrades

APC	ET	PE
•		•
STD		

Door Options

DPSRR
•

SINK BASE

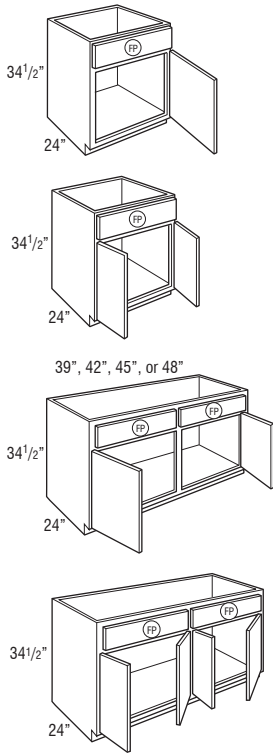

	Price Point	1	2	3	4	5	6	7	8	9	10	11	12
SB21 L or R		668	728	766	804	842	880	935	971	1011	1045	1076	1168
SB24 L or R		702	766	806	847	887	926	983	1023	1063	1101	1132	1229
SB24		739	806	849	892	934	976	1036	1077	1119	1158	1193	1290
SB27		784	839	893	945	998	1051	1114	1157	1205	1247	1280	1387
SB30		851	915	967	1017	1068	1119	1189	1234	1281	1329	1365	1477
SB33		872	934	991	1048	1105	1161	1235	1286	1335	1383	1419	1539
SB36		900	965	1026	1085	1145	1204	1280	1333	1384	1434	1471	1595
SB39		953	1023	1085	1148	1211	1272	1346	1402	1460	1511	1553	1683
SB42		1015	1083	1150	1217	1285	1351	1432	1486	1544	1604	1646	1785
SB45		1072	1146	1214	1281	1348	1416	1501	1562	1621	1683	1728	1872
SB48CS		1129	1208	1277	1345	1413	1482	1572	1636	1699	1763	1809	1958
SB48		1243	1333	1403	1474	1544	1615	1712	1781	1852	1922	1970	2134

• Mini Touch-up Kit (MTUK) included. MTUK includes small touch-up marker and small fill stick.

(FP) = False Panel

Custom Modifications

AUTH	CBO	CCO	CFNTO	CFP	CFRMO	CH	CMAT	CND	CW	DRT	DRWPWR	DRWSEC	DRWTK	DRWWRM	EXBK	EX	FB	FD	FFD	FPEB	FTK	FTK_V	ID	INVFRM	MIP	P	PTOWB	RD	RECTK	RT	SCPDWR	TD	TOTSSS	TVR_V	VTK
•	•	•	•	STD	•	•	• ¹	•	• ²				• ³		•	•	•		•	•	•	•	•		•	•		•	•	•		•		•	

Construction Upgrades

APC	ET	PE
•		•

Door Options

DPSRR
•

¹ Available only on 30", 33", and 36" wide
² Not available on 21", 24" (2 doors), and 48" (4 doors) wide
³ Not available on 39", 42", 45", and 48" wide

SINK BASE with CABMAT™

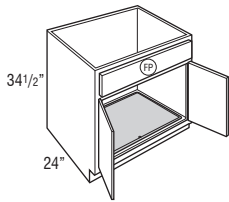

SB30CM	1090	1154	1206	1256	1307	1358	1428	1473	1520	1568	1604	1716
SB33CM	1111	1173	1230	1287	1344	1400	1474	1525	1574	1622	1658	1778
SB36CM	1139	1204	1265	1324	1384	1443	1519	1572	1623	1673	1710	1834

• Mini Touch-up Kit (MTUK) included. MTUK includes small touch-up marker and small fill stick.
 • CabMat™ is designed to capture spills and is removable for cleaning.
 • CabMat™ also available for field installation. See page 311.

(FP) = False Panel

Custom Modifications

AUTH	CBO	CCO	CFNTO	CFP	CFRMO	CH	CMAT	CND	CW	DRT	DRWPWR	DRWSEC	DRWTK	DRWWRM	EXBK	EX	FB	FD	FFD	FPEB	FTK	FTK_V	ID	INVFRM	MIP	P	PTOWB	RD	RECTK	RT	SCPDWR	TD	TOTSSS	TVR_V	VTK
•	•	•	•	STD	•	•	STD	•					•		•	•	•		•	•	•	•	•		•	•		•	•	•		•		•	

Construction Upgrades

APC	ET	PE
•		•

Door Options

DPSRR
•

SINK BASE, 27" DEEP, SINGLE or DOUBLE DOOR

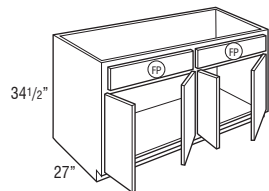
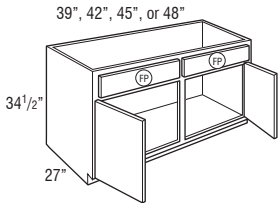
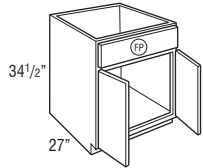
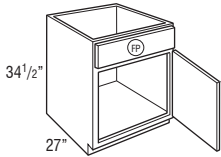

Ⓢ = False Panel

Custom Modifications

AUTH	CBO	CCO	CFNTD	CFP	CFRMO	CH	CMAT	CND	CW	DRT	DRWPWR	DRWSEC	DRWTK	DRWWRM	EXBK	EX	FB	FD	FFD	FPEB	FTK	FTK_V	ID	INVFRM	MIP	P	PTOWB	RD	RECTK	RT	SCPDRW	TD	TOTSSS	TVR_V	VTK
•		•	•	•	STD	•	•		•	• ¹					•	•	•			•	•	•			•	•						•		•	

Construction Upgrades

APC	ET	PE
•		•

Door Options

DPSRR
•

¹ Not available on 24" (2 doors) and 48" (4 doors) wide

Price Point

	1	2	3	4	5	6	7	8	9	10	11	12
SB243427 L or R	737	805	848	889	932	973	1032	1072	1116	1155	1187	1287
SB243427	776	846	890	935	980	1024	1085	1127	1173	1216	1250	1355
SB273427	822	880	936	992	1048	1103	1169	1213	1263	1310	1344	1458
SB303427	893	962	1016	1068	1121	1174	1245	1295	1347	1397	1434	1553
SB333427	917	981	1042	1102	1163	1223	1296	1347	1400	1450	1494	1620
SB363427	942	1015	1079	1141	1204	1267	1344	1398	1454	1505	1547	1677
SB393427	998	1074	1139	1204	1269	1334	1415	1473	1530	1585	1631	1767
SB423427	1062	1140	1210	1279	1348	1417	1504	1566	1626	1683	1730	1876
SB453427	1124	1205	1277	1347	1418	1488	1579	1642	1706	1766	1814	1968
SB483427CS	1185	1270	1342	1413	1485	1557	1651	1718	1786	1848	1900	2060
SB483427	1304	1398	1473	1547	1621	1695	1799	1866	1947	2014	2069	2242

• Mini Touch-up Kit (MTUK) included. MTUK includes small touch-up marker and small fill stick.

129

BASE CABINETS

SINK BASE with TILT-OUT TRAYS

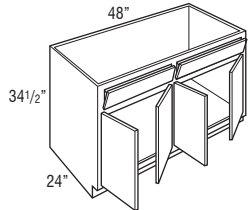
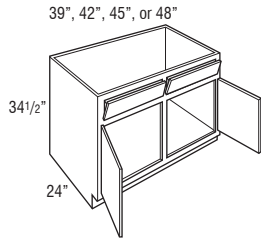
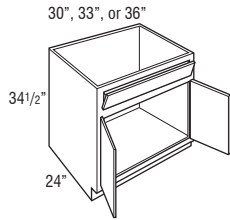
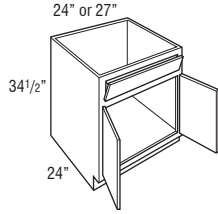
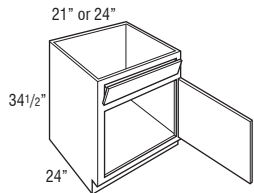

Price Point

	1	2	3	4	5	6	7	8	9	10	11	12
SB21ST L or R	942	1002	1040	1078	1116	1154	1209	1245	1285	1319	1350	1442
SB24ST L or R	976	1040	1080	1121	1161	1200	1257	1297	1337	1375	1406	1503
SB24ST	899	966	1009	1052	1094	1136	1196	1237	1279	1318	1353	1450
SB27ST	944	999	1053	1105	1158	1211	1274	1317	1365	1407	1440	1547
SB30ST	1070	1146	1200	1252	1306	1359	1444	1496	1557	1618	1659	1795
SB33ST	1095	1173	1230	1286	1343	1399	1482	1541	1604	1661	1710	1850
SB36ST	1120	1203	1263	1324	1384	1444	1529	1589	1652	1714	1764	1906
SB39ST	1186	1270	1332	1392	1454	1514	1605	1667	1735	1798	1845	2000
SB42ST	1212	1301	1375	1449	1523	1596	1691	1760	1828	1895	1948	2110
SB45ST	1232	1306	1374	1441	1508	1576	1661	1722	1781	1843	1888	2032
SB48CSST	1289	1368	1437	1505	1573	1642	1732	1796	1859	1923	1969	2118
SB48ST	1403	1493	1563	1634	1704	1775	1872	1941	2012	2082	2130	2294

- Tilt-out trays are stain resistant, moisture resistant plastic to allow storage of sponges and other cleaning materials.
- Mini Touch-up Kit (MTUK) included. MTUK includes small touch-up marker and small fill stick.
- Includes two tilt-out trays on 30"-48" wide.
- Tilt-out trays are also available as an accessory for field installation. See page 315.

Custom Modifications

AUTH	CBO	CCO	CFNTO	CFP	CFRMO	CH	CMAT	CND	CW	DRT	DRWPWR	DRWSEC	DRWTK	DRWWRM	EXBK	EX	FB	FD	FFD	FPEB	FTK	FTK_V	ID	INVFRM	MIP	P	PTOWB	RD	RECTK	RT	SCPDWR	TD	TOTSSS	TVR	VTK
•	•	•	•	•	•	•	•	•	•	•	•	•	• ²	•	•	•	•	•	•	•	•	•	•	•	•	•	•	•	•	•	•	•	•	•	•

Construction Upgrades

APC	ET	PE
•	•	•

Door Options

DPSRR
•

¹ Available only on 30", 33", and 36" wide
² Not available on 39", 42", 45", and 48" wide

SINK BASE with TILT-OUT TRAYS and CABMAT™

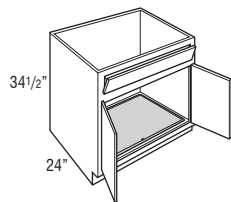

	Price Point	1	2	3	4	5	6	7	8	9	10	11	12
SB30STCM		1309	1385	1439	1491	1545	1598	1683	1735	1796	1857	1898	2034
SB33STCM		1334	1412	1469	1525	1582	1638	1721	1780	1843	1900	1949	2089
SB36STCM		1359	1442	1502	1563	1623	1683	1768	1828	1891	1953	2003	2145

- Mini Touch-up Kit (MTUK) included. MTUK includes small touch-up marker and small fill stick.
- CabMat™ is designed to capture spills and is removable for cleaning.
- Tilt-out trays are stain resistant, moisture resistant plastic to allow storage of sponges and other cleaning materials.
- Includes two tilt-out trays.
- Tilt-out trays are also available as an accessory for field installation. See page 315.
- CabMat™ also available for field installation. See page 311.

Custom Modifications

AUTH	CBO	CCO	CFNTO	CFP	CFRMO	CH	CMAT	CND	CW	DRT	DRWPWR	DRWSEC	DRWTK	DRWWRM	EXBK	EX	FB	FD	FFD	FPEB	FTK	FTK_V	ID	INVFRM	MIP	P	PTOWB	RD	RECTK	RT	SCPRDW	TD	TOTSSS	TVR_V	VTK	
•	•	•	•	•	•	•	•	•	•	•	•	•	•	•	•	•	•	•	•	•	•	•	•	•	•	•	•	•	•	•	•	•	•	•	•	•

Construction Upgrades

APC	ET	PE
•	•	•

Door Options

DPSRR
•

SINK BASE with TILT-OUT TRAYS, 27" DEEP

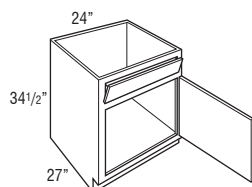

SB243427ST L or R

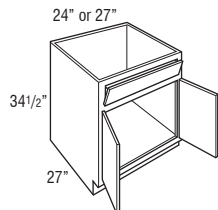

SB243427ST-SB273427ST

30", 33", or 36"

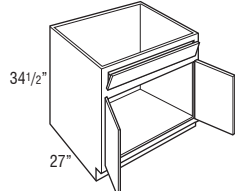

SB303427ST-SB363427ST

39", 42", 45", or 48"

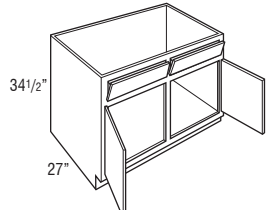

SB393427ST-SB483427CSST

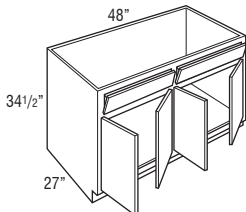

SB483427ST

SB243427ST L or R	1011	1079	1122	1163	1206	1247	1306	1346	1390	1429	1461	1561
SB243427ST	936	1006	1050	1095	1140	1184	1245	1287	1333	1376	1410	1515
SB273427ST	982	1040	1096	1152	1208	1263	1329	1373	1423	1470	1504	1618
SB303427ST	1120	1204	1260	1316	1372	1427	1515	1574	1639	1695	1743	1889
SB333427ST	1150	1235	1294	1352	1410	1468	1558	1618	1683	1745	1792	1942
SB363427ST	1177	1261	1326	1390	1454	1518	1608	1671	1738	1799	1848	2004
SB393427ST	1244	1334	1398	1462	1525	1588	1684	1752	1822	1888	1941	2106
SB423427ST	1273	1366	1445	1522	1599	1677	1779	1849	1921	1991	2046	2215
SB453427ST	1284	1365	1437	1507	1578	1648	1739	1802	1866	1926	1974	2128
SB483427CSST	1345	1430	1502	1573	1645	1717	1811	1878	1946	2008	2060	2220
SB483427ST	1464	1558	1633	1707	1781	1855	1959	2026	2107	2174	2229	2402

- Tilt-out trays are stain resistant, moisture resistant plastic to allow storage of sponges and other cleaning materials.
- Mini Touch-up Kit (MTUK) included. MTUK includes small touch-up marker and small fill stick.
- Includes two tilt-out trays on 30"-48" wide.
- Tilt-out trays are also available as an accessory for field installation. See page 315.

Custom Modifications

AUTH	CBO	CCO	CFNTO	CFP	CFRMO	CH	CMAT	CND	CW	DRT	DRWPWR	DRWSEC	DRWTK	DRWWRM	EXBK	EX	FB	FD	FFD	FPEB	FTK	FTK_V	ID	INVFRM	MIP	P	PTOWB	RD	RECTK	RT	SCPRDW	TD	TOTSSS	TVR_V	VTK
•	•	•	•	•	•	•	•	•	•	•	•	•	•	•	•	•	•	•	•	•	•	•	•	•	•	•	•	•	•	•	•	•	•	•	•

Construction Upgrades

APC	ET	PE
•	•	•

Door Options

DPSRR
•

Price Point	1	2	3	4	5	6	7	8	9	10	11	12
-------------	---	---	---	---	---	---	---	---	---	----	----	----

SINK BASE SUPERCABINET™

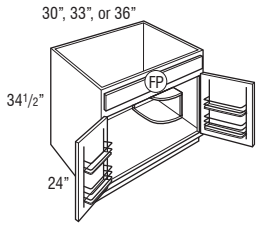

SB30S	1244	1308	1360	1410	1461	1512	1582	1627	1674	1722	1758	1870
SB33S	1265	1327	1384	1441	1498	1554	1628	1679	1728	1776	1812	1932
SB36S	1293	1358	1419	1478	1538	1597	1673	1726	1777	1827	1864	1988

- Quarter Round Reversible Shelf for left or right applications will be constructed from 3/4" thick laminated furniture board. (Shelf shipped secure, can be positioned in left or right corner.)
- Mini Touch-up Kit (MTUK) included. MTUK includes small touch-up marker and small fill stick.
- Each door features a chrome and wood two-tiered rack.
- Door rack width is 11 3/8" on 30" and 33" wide cabinets and 14 3/8" on 36" wide cabinet.
- Door rack depth is 3 1/2".

FP = False Panel

Custom Modifications

AUTH	CBO	CCO	CFNTO	CFP	CFRMO	CH	CMAT	CND	CW	DRT	DRWPWR	DRWSEC	DRWTK	DRWWRM	EXBK	EX	FB	FD	FFD	FPEB	FTK	FTK_V	ID	INVERM	MIP	P	PTOWB	RD	RECTK	RT	SCPDRW	TD	TOTSSS	TVR_V	VTK	
•	•	•	•	•	•	•	•	•	•	•	•	•	•	•	•	•	•	•	•	•	•	•	•	•	•	•	•	•	•	•	•	•	•	•	•	•

Construction Upgrades

APC	ET	PE
•	•	•

Door Options

DPSRR
•

SINK BASE SUPERCABINET™ with CABMAT™

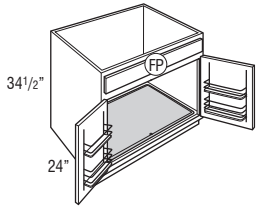

SB30SCM	1483	1547	1599	1649	1700	1751	1821	1866	1913	1961	1997	2109
SB33SCM	1504	1566	1623	1680	1737	1793	1867	1918	1967	2015	2051	2171
SB36SCM	1532	1597	1658	1717	1777	1836	1912	1965	2016	2066	2103	2227

- Mini Touch-up Kit (MTUK) included. MTUK includes small touch-up marker and small fill stick.
- CabMat™ is designed to capture spills and is removable for cleaning.
- Each door features a chrome and wood two-tiered rack.
- Door rack width is 11 3/8" on 30" and 33" wide cabinets and 14 3/8" on 36" wide cabinet.
- Door rack depth is 3 1/2".
- CabMat™ also available for field installation. See page 311.

FP = False Panel

Custom Modifications

AUTH	CBO	CCO	CFNTO	CFP	CFRMO	CH	CMAT	CND	CW	DRT	DRWPWR	DRWSEC	DRWTK	DRWWRM	EXBK	EX	FB	FD	FFD	FPEB	FTK	FTK_V	ID	INVERM	MIP	P	PTOWB	RD	RECTK	RT	SCPDRW	TD	TOTSSS	TVR_V	VTK	
•	•	•	•	•	•	•	•	•	•	•	•	•	•	•	•	•	•	•	•	•	•	•	•	•	•	•	•	•	•	•	•	•	•	•	•	•

Construction Upgrades

APC	ET	PE
•	•	•

Door Options

DPSRR
•

SINK BASE SUPERCABINET™ with TILT-OUT TRAYS

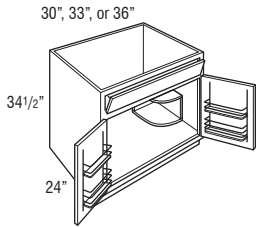

SB30STS	1463	1539	1593	1645	1699	1752	1837	1889	1950	2011	2052	2188
SB33STS	1488	1566	1623	1679	1736	1792	1875	1934	1997	2054	2103	2243
SB36STS	1513	1596	1656	1717	1777	1837	1922	1982	2045	2107	2157	2299

- Quarter Round Reversible Shelf for left or right applications will be constructed from 3/4" thick laminated furniture board. (Shelf shipped secure, can be positioned in left or right corner.)
- Mini Touch-up Kit (MTUK) included. MTUK includes small touch-up marker and small fill stick.
- Includes two tilt-out trays.
- Tilt-out trays are stain resistant, moisture resistant plastic to allow storage of sponges and other cleaning materials.
- Tilt-out trays are also available as an accessory for field installation. See page 315.
- Each door features a chrome and wood two-tiered rack.
- Door rack width is 11 3/8" on 30" and 33" wide cabinets and 14 3/8" on 36" wide cabinet.
- Door rack depth is 3 1/2".

Custom Modifications

AUTH	CBO	CCO	CFNTO	CFP	CFRMO	CH	CMAT	CND	CW	DRT	DRWPWR	DRWSEC	DRWTK	DRWWRM	EXBK	EX	FB	FD	FFD	FPEB	FTK	FTK_V	ID	INVERM	MIP	P	PTOWB	RD	RECTK	RT	SCPDRW	TD	TOTSSS	TVR_V	VTK	
•	•	•	•	•	•	•	•	•	•	•	•	•	•	•	•	•	•	•	•	•	•	•	•	•	•	•	•	•	•	•	•	•	•	•	•	•

Construction Upgrades

APC	ET	PE
•	•	•

Door Options

DPSRR
•

SINK BASE SUPERCABINET™ with TILT-OUT TRAYS and CABMAT™

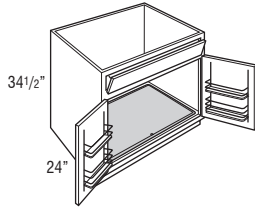

Price Point	1	2	3	4	5	6	7	8	9	10	11	12
SB30STSCM	1702	1778	1832	1884	1938	1991	2076	2128	2189	2250	2291	2427
SB33STSCM	1727	1805	1862	1918	1975	2031	2114	2173	2236	2293	2342	2482
SB36STSCM	1752	1835	1895	1956	2016	2076	2161	2221	2284	2346	2396	2538

- Mini Touch-up Kit (MTUK) included. MTUK includes small touch-up marker and small fill stick.
- CabMat™ is designed to capture spills and is removable for cleaning.
- Includes two tilt-out trays.
- Tilt-out trays are stain resistant, moisture resistant plastic to allow storage of sponges and other cleaning materials.
- Tilt-out trays are also available as an accessory for field installation. See page 315.
- Each door features a chrome and wood two-tiered rack.
- Door rack width is 11 3/8" on 30" and 33" wide cabinets and 14 3/8" on 36" wide cabinet.
- Door rack depth is 3 1/2".
- CabMat™ also available for field installation. See page 311.

Custom Modifications

AUTH	CBO	CCO	CFNTO	CFP	CFRMO	CH	CMAT	CND	CW	DRT	DRWPWR	DRWSEC	DRWTK	DRWWRM	EXBK	EX	FB	FD	FFD	FPEB	FTK	FTK_V	ID	INVFRM	MIP	P	PTOWB	RD	RECTK	RT	SCPDRW	TD	TOTSSS	TVR_V	VTK	
•	•	•	•	•	•	•	•	•	•	•	•	•	•	•	•	•	•	•	•	•	•	•	•	•	•	•	•	•	•	•	•	•	•	•	•	•

Construction Upgrades

APC	ET	PE
•	•	•

Door Options

DPSRR
•

SINK BASE with DRAWER BELOW

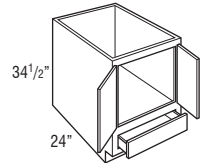
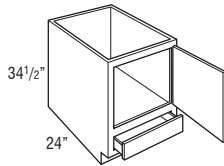

39", 42", 45", or 48"

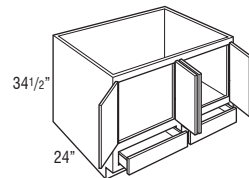
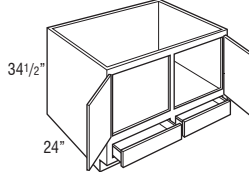

SB24D L or R	1120	1126	1138	1150	1163	1175	1238	1289	1334	1378	1412	1525
---------------------	------	------	------	------	------	------	------	------	------	------	------	------

SB24D	1182	1187	1200	1212	1224	1235	1307	1354	1403	1449	1487	1605
SB27D	1324	1351	1370	1389	1408	1426	1469	1522	1583	1634	1677	1811
SB30D	1380	1392	1409	1425	1441	1457	1539	1597	1658	1712	1758	1902
SB33D	1419	1434	1452	1468	1485	1502	1586	1649	1709	1767	1816	1959
SB36D	1460	1473	1495	1518	1540	1562	1650	1711	1780	1839	1886	2038

SB39D	1663	1671	1688	1705	1721	1737	1833	1897	1966	2027	2080	2244
SB42D	1748	1757	1774	1791	1808	1823	1925	1992	2068	2132	2185	2360
SB45D	1823	1860	1885	1908	1932	1956	2089	2167	2236	2290	2475	
SB48DCS	1900	1912	1933	1954	1976	1997	2109	2185	2266	2336	2396	2591

SB48D	2048	2074	2099	2122	2146	2169	2293	2376	2464	2544	2608	2818
--------------	------	------	------	------	------	------	------	------	------	------	------	------

- Drawers are below full cabinet floor.
- Mini Touch-up Kit (MTUK) included. MTUK includes small touch-up marker and small fill stick.
- Verify that sink, garbage disposal and plumbing fit opening.
- Plumbing going through floor will interfere with drawer operation. 2 3/4" clearance from back of drawer to interior back of cabinet.
- Face frame opening height is 20 1/2".
- Face frame opening height for drawer is 4 1/2".

Custom Modifications

AUTH	CBO	CCO	CFNTO	CFP	CFRMO	CH	CMAT	CND	CW	DRT	DRWPWR	DRWSEC	DRWTK	DRWWRM	EXBK	EX	FB	FD	FFD	FPEB	FTK	FTK_V	ID	INVFRM	MIP	P	PTOWB	RD	RECTK	RT	SCPDRW	TD	TOTSSS	TVR_V	VTK
•	•	•	•	•	•	•	• ¹	•	• ²	•	•	•	• ³	•	•	•	•	•	•	•	•	•	•	•	•	•	•	•	•	•	•	•	•	•	•

Construction Upgrades

APC	ET	PE
•	•	•

Door Options

DPSRR
•

¹ Available only on 30", 33", and 36" wide
² Not available on 24" (2 doors), 39", and 48" (4 doors) wide
³ Not available on 39", 42", 45", and 48" wide

SINK FRONT BOTTOM

SFB48

84

84

84

84

84

84

84

84

84

84

84

84

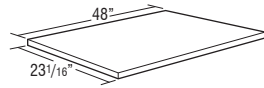

- Designed for use with Sink Bases ordered with CFNTO.
- 3/8" thick.
- Trimmable.

Custom Modifications

AUTH	CBO	CCO	CFNTO	CFP	CFRMO	CH	CMAT	CND	CW	DRT	DRWPWR	DRWSEC	DRWTK	DRWWRM	EXBK	EX	FB	FD	FFD	FPEB	FTK	FTK_V	ID	INVFRM	MIP	P	PTOWB	RD	RECTK	RT	SCPDWR	TD	TOTSSS	TVR_V	VTK			

Construction Upgrades

APC	ET	PE
•		

Door Options

DPSRR

134

BASE CABINETS

ANGLED CORNER SINK BASE

ACS36 L or R

1217

1354

1421

1487

1555

1621

1718

1785

1857

1925

1978

2141

ACS39 L or R

1278

1420

1492

1562

1633

1704

1804

1878

1952

2024

2079

2251

ACS42[†]

1382

1533

1598

1662

1726

1790

1897

1971

2050

2128

2185

2364

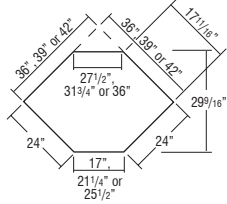
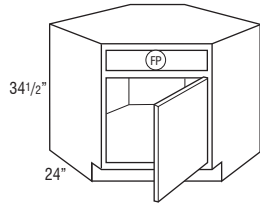

Max. Sink Widths if cut-out is 4" back from face of front frame

- Edges beveled at 45°.
- Mini Touch-up Kit (MTUK) included. MTUK includes small touch-up marker and small fill stick.
- For sufficient dishwasher door clearance and loading/unloading space, a 15" wide base cabinet is recommended for use between a corner sink base and dishwasher.
- For ACS36, full overlay styles use the same width doors as partial overlay styles (14 1/2" wide) with a partial overlay hinge (38NPOHINGE) to allow for proper door clearance with adjacent cabinets.

[†]ACS42 has butt doors.

Model	Wall Width	Frame	Maximum Sink Width	Maximum Sink Depth
ACS36	36" x 36"	17"	25 3/4"	27 11/32"
ACS39	39" x 39"	21 1/4"	30"	27 11/32"
ACS42	42" x 42"	25 1/2"	34 1/4"	27 11/32"

(FP) = False Panel

Custom Modifications

AUTH	CBO	CCO	CFNTO	CFP	CFRMO	CH	CMAT	CND	CW	DRT	DRWPWR	DRWSEC	DRWTK	DRWWRM	EXBK	EX	FB	FD	FFD	FPEB	FTK	FTK_V	ID	INVFRM	MIP	P	PTOWB	RD	RECTK	RT	SCPDWR	TD	TOTSSS	TVR_V	VTK	
•		•	•	•	•	•	•	•	•								•			•	•	•			•			•								•

Construction Upgrades

APC	ET	PE
•		•

Door Options

DPSRR
•

**ANGLED CORNER SINK FRONT
without SINK FLOOR**

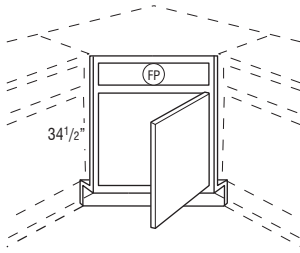

Max. Sink Widths if cut-out is 4" back from face of front frame

FP = False Panel

Custom Modifications

AUTH	CBO	CCO	CFNTO	CFP	CFRMO	CH	CMAT	CND	CW	DRT	DRWPWR	DRWSEC	DRWTK	DRWWRM	EXBK	EX	FB	FD	FFD	FPEB	FTK	FTK_V	ID	INVFRM	MIP	P	PTOWB	RD	RECTK	RT	SCPDRW	TD	TOTSSS	TVR_V	VTK		
			STD	STD																																	

Construction Upgrades

APC	ET	PE

Door Options

DPSRR

	Price Point	1	2	3	4	5	6	7	8	9	10	11	12
ACSF36 L or R		470	505	544	584	623	662	702	730	759	786	809	877
ACSF39 L or R		515	552	598	643	688	732	776	808	839	869	894	969
ACSF42[†]		727	777	829	879	930	980	1040	1081	1124	1161	1196	1294

- Edges beveled at 45°.
 - Angled corner sink front bottom required for field installation. Order separately. See next item.
 - Toekick and toekick retainer shipped unattached from the face frame.
 - For ACSF36, full overlay styles use the same width doors as partial overlay styles (14 1/2" wide) with a partial overlay hinge (38NPOHINGE) to allow for proper door clearance with adjacent cabinets.
 - For sufficient dishwasher door clearance and loading/unloading space, a 15" wide base cabinet is recommended for use between a corner sink base and dishwasher.
- [†]ACSF42 has butt doors.

Model	Wall Width	Frame	Maximum Sink Width	Maximum Sink Depth
ACSF36	36" x 36"	17"	25 3/4"	27 11/32"
ACSF39	39" x 39"	21 1/4"	30"	27 11/32"
ACSF42	42" x 42"	25 1/2"	34 1/4"	27 11/32"

**ANGLED CORNER SINK FRONT
BOTTOM**

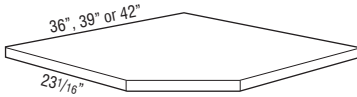

ACSF36	140	140	140	140	140	140	140	140	140	140	140	140	140
ACSF39	157	157	157	157	157	157	157	157	157	157	157	157	157
ACSF42	167	167	167	167	167	167	167	167	167	167	167	167	167

- Designed for use with Angled Corner Sink Front.
- Cabinet bottom is sized for use next to an adjacent wall or cabinet with flush ends.
- 3/8" thick.
- Trimmable.

Custom Modifications

AUTH	CBO	CCO	CFNTO	CFP	CFRMO	CH	CMAT	CND	CW	DRT	DRWPWR	DRWSEC	DRWTK	DRWWRM	EXBK	EX	FB	FD	FFD	FPEB	FTK	FTK_V	ID	INVFRM	MIP	P	PTOWB	RD	RECTK	RT	SCPDRW	TD	TOTSSS	TVR_V	VTK		

Construction Upgrades

APC	ET	PE

Door Options

DPSRR

COUNTRY SINK BASE

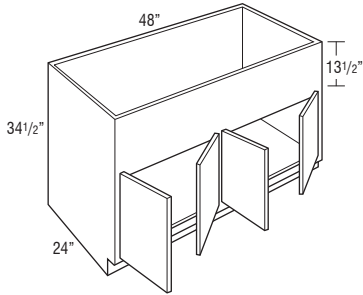
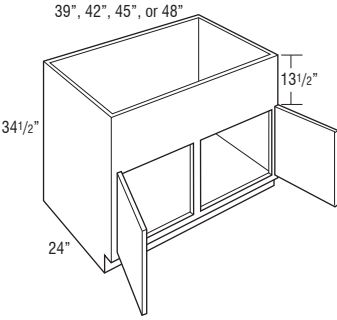
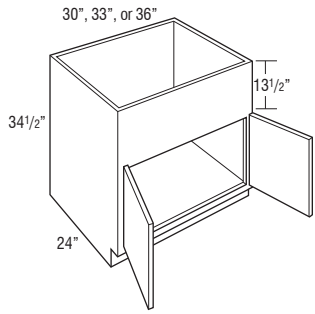

Price Point

	1	2	3	4	5	6	7	8	9	10	11	12
CNTYSB30	851	915	967	1017	1068	1119	1189	1234	1281	1329	1365	1477
CNTYSB33	876	936	993	1049	1105	1161	1234	1281	1334	1382	1418	1536
CNTYSB36	900	965	1026	1085	1145	1204	1280	1333	1384	1434	1471	1595
CNTYSB39	977	1046	1109	1172	1234	1296	1375	1429	1486	1540	1583	1712
CNTYSB42	1036	1108	1175	1242	1309	1375	1460	1515	1578	1633	1678	1817
CNTYSB45	1095	1170	1241	1312	1382	1452	1541	1602	1668	1727	1773	1922
CNTYSB48CS	1152	1234	1309	1383	1457	1531	1624	1687	1756	1818	1867	2024
CNTYSB48	1270	1359	1441	1523	1605	1687	1788	1858	1933	2003	2056	2230

- 13 1/2" panel can be trimmed up to 12".
- Mini Touch-up Kit (MTUK) included. MTUK includes small touch-up marker and small fill stick.
- For apron front sinks requiring smaller cut-out heights, see Country Sink Base with Short Apron on page 138 or Base Drop-in Range Cabinets on page 165.
- Refer to sink manufacturer's recommendations for additional support required for apron front sinks.

Custom Modifications

AUTH	CBO	CCO	CFNTO	CFP	CFRMO	CH	CMAT	CND	CW	DRT	DRWPWR	DRWSEC	DRWTK	DRWWRM	EXBK	EX	FB	FD	FFD	FPEB	FTK	FTK_V	ID	INVFRM	MIP	P	PTOWB	RD	RECTK	RT	SCPDRW	TD	TOTSSS	TVR	V	VTK
•	•	•	•	•	•	•	• ¹	• ²	• ³	•	•	•	• ⁴	•	•	•	•	•	•	•	•	•	•	•	•	•	•	•	•	•	•	•	•	•	•	•

Construction Upgrades

APC	ET	PE
•	•	•

Door Options

DPSRR
•

¹ Minimum height is 32" (top panel height remains the same)
² Available only on 30", 33", and 36" wide
³ Not available on 48" (4 doors) wide
⁴ Not available on 39", 42", 45", and 48" wide

COUNTRY SINK BASE with CABMAT™

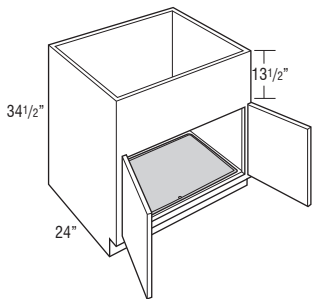

CNTYSB30CM	1090	1154	1206	1256	1307	1358	1428	1473	1520	1568	1604	1716
CNTYSB33CM	1115	1175	1232	1288	1344	1400	1473	1520	1573	1621	1657	1775
CNTYSB36CM	1139	1204	1265	1324	1384	1443	1519	1572	1623	1673	1710	1834

- Mini Touch-up Kit (MTUK) included. MTUK includes small touch-up marker and small fill stick.
- CabMat™ is designed to capture spills and is removable for cleaning.
- 13 1/2" panel can be trimmed to 12".
- For apron front sinks requiring smaller cut-out heights, see Country Sink Base with Short Apron on page 138 or Base Drop-in Range Cabinets on page 165.
- Refer to sink manufacturer's recommendations for additional support required for apron front sinks.
- CabMat™ also available for field installation. See page 311.

Custom Modifications

AUTH	CBO	CCO	CFNTO	CFP	CFRMO	CH	CMAT	CND	CW	DRT	DRWPWR	DRWSEC	DRWTK	DRWWRM	EXBK	EX	FB	FD	FFD	FPEB	FTK	FTK_V	ID	INVFRM	MIP	P	PTOWB	RD	RECTK	RT	SCPDRW	TD	TOTSSS	TVR	V	VTK	
•	•	•	•	•	•	•	•	•	•	•	•	•	•	•	•	•	•	•	•	•	•	•	•	•	•	•	•	•	•	•	•	•	•	•	•	•	•

Construction Upgrades

APC	ET	PE
•	•	•

Door Options

DPSRR
•

¹ Minimum height is 32" (top panel height remains the same)

COUNTRY SINK BASE, 27" DEEP

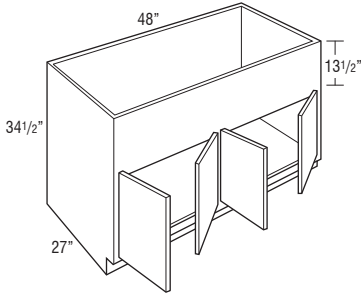
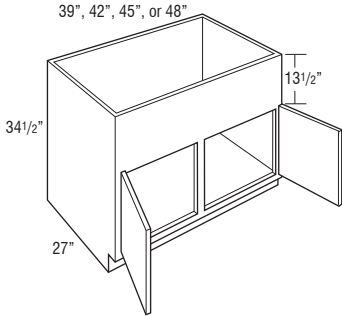
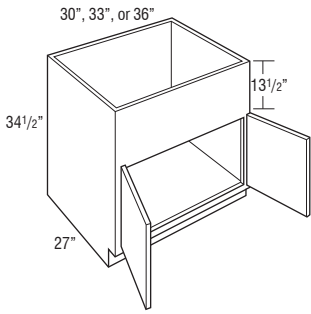

Price Point

	1	2	3	4	5	6	7	8	9	10	11	12
CNTYSB303427	911	975	1027	1077	1128	1179	1249	1294	1341	1389	1425	1537
CNTYSB333427	936	996	1053	1109	1165	1221	1294	1341	1394	1442	1478	1596
CNTYSB363427	960	1025	1086	1145	1205	1264	1340	1393	1444	1494	1531	1655
CNTYSB393427	1037	1106	1169	1232	1294	1356	1435	1489	1546	1600	1643	1772
CNTYSB423427	1096	1168	1235	1302	1369	1435	1520	1575	1638	1693	1738	1877
CNTYSB453427	1155	1230	1301	1372	1442	1512	1601	1662	1728	1787	1833	1982
CNTYSB483427CS	1212	1294	1369	1443	1517	1591	1684	1747	1816	1878	1927	2084
CNTYSB483427	1330	1419	1501	1583	1665	1747	1848	1918	1993	2063	2116	2290

- 13 1/2" panel can be trimmed up to 12".
- Mini Touch-up Kit (MTUK) included. MTUK includes small touch-up marker and small fill stick.
- For apron front sinks requiring smaller cut-out heights, see Country Sink Base with Short Apron on page 138 or Base Drop-in Range Cabinets on page 165.
- Refer to sink manufacturer's recommendations for additional support required for apron front sinks.

Custom Modifications

AUTH	CBO	CCO	CFNTO	CFP	CFRMO	CH	CMAI	CND	CW	DRT	DRWPWR	DRWSEC	DRWTK	DRWWRM	EXBK	EX	FB	FD	FFD	FPEB	FTK	FTK_V	ID	INVFRM	MIP	P	PTOWB	RD	RECTK	RT	SCDRW	TD	TOTSSS	TVR_V	VTK	
•	•	•	•	•	•	• ¹	•	•	• ²	•	•	•	•	•	•	•	•	•	•	•	•	•	•	•	•	•	•	•	•	•	•	•	•	•	•	•

Construction Upgrades

APC	ET	PE
•	•	•

Door Options

DPSRR
•

¹ Minimum height is 32" (top panel height remains the same)

² Not available on 48" (4 doors) wide

COUNTRY SINK BASE with SHORT APRON

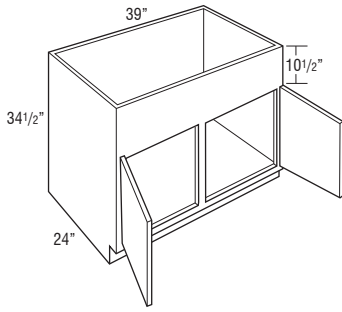
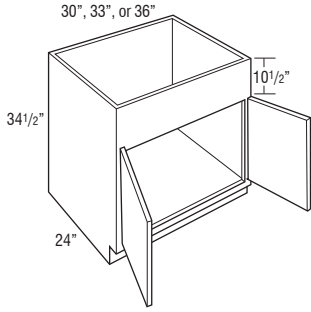

Custom Modifications

AUTH	CBO	CCO	CFNTO	CFP	CFRMO	CH	CMAT	CND	CW	DRT	DRWPWR	DRWSEC	DRWTK	DRWWRM	EXBK	EX	FB	FD	FFD	FPEB	FTK	FTK_V	ID	INVFRM	MIP	P	PTOWB	RD	RECTK	RT	SCPDRW	TD	TOTSSS	TVR_V	VTK		
•	•	•	•	•	•	• ¹	• ²	•	•	•	•	•	• ²	•	•	•	•	•	•	•	•	•	•	•	•	•	•	•	•	•	•	•	•	•	•	•	•

Construction Upgrades

APC	ET	PE
•	•	•

Door Options

DPSRR
•

¹ Minimum height is 27 1/2" (top panel height remains the same)
² Not available on 39" wide

Price Point

	1	2	3	4	5	6	7	8	9	10	11	12
CNTYSB30SA	851	915	967	1017	1068	1119	1189	1234	1281	1329	1365	1477
CNTYSB33SA	876	936	993	1049	1105	1161	1234	1281	1334	1382	1418	1536
CNTYSB36SA	900	965	1026	1085	1145	1204	1280	1333	1384	1434	1471	1595

CNTYSB39SA	977	1046	1109	1172	1234	1296	1375	1429	1486	1540	1583	1712
-------------------	-----	------	------	------	------	------	------	------	------	------	------	------

- 10 1/2" panel can be trimmed up to 9".
- Mini Touch-up Kit (MTUK) included. MTUK includes small touch-up marker and small fill stick.
- For apron front sinks requiring a cut-out height of 6 1/2" or less, see Base Drop-in Range Cabinets on page 165.
- Refer to sink manufacturer's recommendations for additional support required for apron front sinks.

COUNTRY SINK BASE with SHORT APRON, 27" DEEP

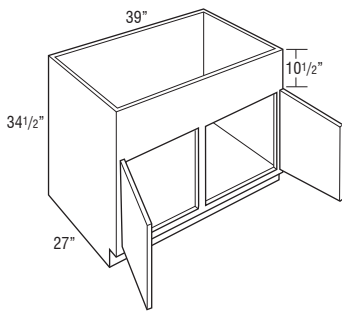
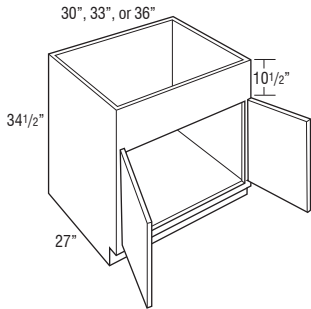

Custom Modifications

AUTH	CBO	CCO	CFNTO	CFP	CFRMO	CH	CMAT	CND	CW	DRT	DRWPWR	DRWSEC	DRWTK	DRWWRM	EXBK	EX	FB	FD	FFD	FPEB	FTK	FTK_V	ID	INVFRM	MIP	P	PTOWB	RD	RECTK	RT	SCPDRW	TD	TOTSSS	TVR_V	VTK		
•	•	•	•	•	•	• ¹	•	•	•	•	•	•	•	•	•	•	•	•	•	•	•	•	•	•	•	•	•	•	•	•	•	•	•	•	•	•	•

Construction Upgrades

APC	ET	PE
•	•	•

Door Options

DPSRR
•

¹ Minimum height is 27 1/2" (top panel height remains the same)

CNTYSB303427SA	911	975	1027	1077	1128	1179	1249	1294	1341	1389	1425	1537
CNTYSB333427SA	936	996	1053	1109	1165	1221	1294	1341	1394	1442	1478	1596
CNTYSB363427SA	960	1025	1086	1145	1205	1264	1340	1393	1444	1494	1531	1655

CNTYSB393427SA	1037	1106	1169	1232	1294	1356	1435	1489	1546	1600	1643	1772
-----------------------	------	------	------	------	------	------	------	------	------	------	------	------

- 10 1/2" panel can be trimmed up to 9".
- Mini Touch-up Kit (MTUK) included. MTUK includes small touch-up marker and small fill stick.
- For apron front sinks requiring a cut-out height of 6 1/2" or less, see Base Drop-in Range Cabinets on page 165.
- Refer to sink manufacturer's recommendations for additional support required for apron front sinks.

Sink Base Corner Cabinets

- SBCs use the wall space the nomenclature implies.
- Remember to use 3" filler on adjoining cabinets.
- The adjoining run of cabinets will cover the void.
- The L or R in the cabinet nomenclature indicates the location of the void to ensure clearance.
- It is not recommended to place SBC cabinets next to appliances where any face component is deeper than 27".

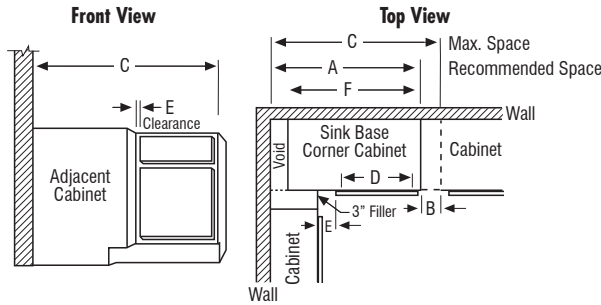

Model	A Recommended Space	B Max. Pull*	C Max. Space	D Face Frame Opening	E* Full Overlay		E* Partial Overlay		F Actual Cabinet
					At Min.**	At Max.	At Min.**	At Max.	
SBC51	51"	4 1/2"	55 1/2"	21"	3 1/4"	7 3/4"	4"	8 1/2"	48"
SBC54	54"	4 1/2"	58 1/2"	24"	3 1/4"	7 3/4"	4"	8 1/2"	51"
SBC57	57"	4 1/2"	61 1/2"	27"	3 1/4"	7 3/4"	4"	8 1/2"	54"
SBC60	60"	4 1/2"	64 1/2"	30"	3 1/4"	7 3/4"	4"	8 1/2"	57"
SBC63	63"	4 1/2"	67 1/2"	33"	3 1/4"	7 3/4"	4"	8 1/2"	60"

*Minimum/maximum space between inside edge of door and face of filler/adjoining cabinet. If cabinet is pulled to maximum stated dimension, filler will need to be cleated for proper attachment.

**When using hardware on cabinet doors/drawers, additional clearance may be needed.

SINK BASE CORNER	Price Point	1	2	3	4	5	6	7	8	9	10	11	12
		SBC51 L or R	1071	1133	1167	1201	1234	1268	1342	1389	1444	1491	1531
SBC54 L or R	1215	1288	1326	1364	1402	1439	1523	1577	1640	1693	1738	1877	
SBC57 L or R	1225	1297	1336	1374	1412	1450	1536	1589	1653	1707	1752	1892	
SBC60 L or R	1234	1308	1347	1385	1425	1463	1548	1603	1667	1720	1765	1906	
SBC63 L or R	1244	1317	1356	1396	1435	1474	1559	1615	1679	1734	1780	1922	

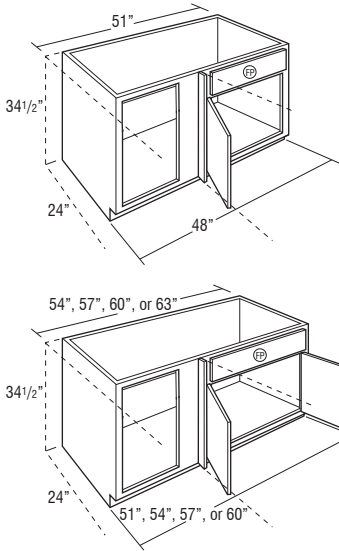

- On void side, do not install next to an appliance deeper than standard cabinet depth due to clearance needed for the door.
- Includes one 3" filler, shipped unattached.
- L or R indicates void. L (left) void shown.
- Mini Touch-up Kit (MTUK) included. MTUK includes small touch-up marker and small fill stick.

	Sink Base Frame Opening Width	Sink Base Cabinet Equivalent Width	# of Doors	Full Overlay Door Size		Partial Overlay Door Size	
				Width	Height	Width	Height
SBC51	21"	24"	1	23 1/2"	23"	22"	21 1/2"
SBC54	24"	27"	2	13 3/16"	23"	12 7/16"	21 1/2"
SBC57	27"	30"	2	14 11/16"	23"	13 15/16"	21 1/2"
SBC60	30"	33"	2	16 3/16"	23"	15 7/16"	21 1/2"
SBC63	33"	36"	2	17 11/16"	23"	16 15/16"	21 1/2"

Ⓢ = False Panel

Custom Modifications

AUTH	CBO	CCO	CFNTO	CFP	CFRMO	CH	CMAT	CND	CW	DRT	DRWPWR	DRWSEC	DRWTK	DRWWRM	EXBK	EX	FB	FD	FFD	FPEB	FTK	V	ID	INVFRM	MIP	P	PTOWB	RD	RECTK	RT	SCPRW	TD	TOTSS	TVR	V	VTK
•	•	•	•	STD	•	•	•	• ¹	•	•	•	•	•	•	•	•	•	•	• ²	•	•	•	•	•	•	•	•	•	•	•	•	•	•	•	•	•

Construction Upgrades

APC	ET	PE
•	•	•

Door Options

DPSRR
•

¹ Width reduction is taken from door section and does not affect corner void or clearance dimensions. Not available on SBC51.
² Face Frame and Door on End modification not available on the void side of the cabinet.

Base Corner Cabinets

- BCs use the wall space the nomenclature implies.
- Remember to use 3" filler on adjoining cabinets.
- The adjoining run of cabinets will cover the void.
- BCFW specifies full width base corner cabinet.
- The L or R in the cabinet nomenclature indicates the location of the void to ensure clearance.
- It is not recommended to place BC cabinets next to appliances where any face component is deeper than 27".

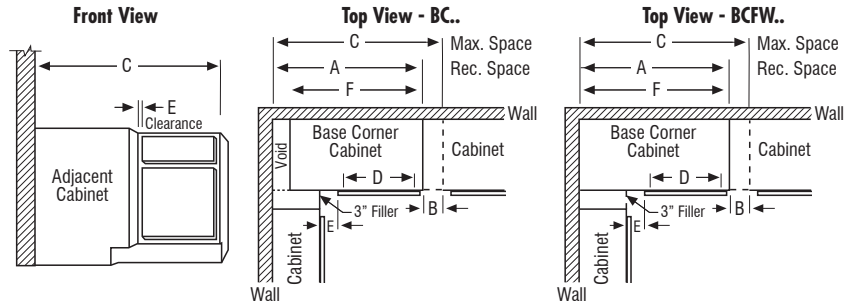

Model	A Recommended Space	B Max. Pull*	C Max. Space	D Face Frame Opening	E* Full Overlay		E* Partial Overlay		F Actual Cabinet	Full Overlay Door Width	Partial Overlay Door Width
					At Min.**	At Max.	At Min.**	At Max.			
BC36	36"	6"	42"	7 1/2"	1 3/4"	7 3/4"	2 1/2"	8 1/2"	27"	10"	8 1/2"
BC39	39"	4 1/2"	43 1/2"	9"	3 1/4"	7 3/4"	4"	8 1/2"	30"	11 1/2"	10"
BC42	42"	6"	48"	13 1/2"	1 3/4"	7 3/4"	2 1/2"	8 1/2"	39"	16"	14 1/2"
BC45/BC45PO	45"	4 1/2"	49 1/2"	15"	3 1/4"	7 3/4"	4"	8 1/2"	42"	17 1/2"	16"
BC48/BC48PO	48"	3"	51"	16 1/2"	4 3/4"	7 3/4"	5 1/2"	8 1/2"	45"	19"	17 1/2"
BCFW36/BCFW36FH	36"	5"	41"	7 1/2"	1 3/4"	6 3/4"	2 1/2"	7 1/2"	36"	10"	8 1/2"
BCFW39/BCFW39FH	39"	3 1/2"	42 1/2"	9"	3 1/4"	6 3/4"	4"	7 1/2"	39"	11 1/2"	10"
BCFW42/BCFW42FH	42"	9"	51"	13 1/2"	1 3/4"	10 3/4"	2 1/2"	11 1/2"	42"	16"	14 1/2"
BCFW45/BCFW45FH/BCFW45PO	45"	7 1/2"	52 1/2"	15"	3 1/4"	10 3/4"	4"	11 1/2"	45"	17 1/2"	16"
BCFW48/BCFW48CPD/BCFW48FH/BCFW48PO	48"	4 1/2"	52 1/2"	18"	3 1/4"	7 3/4"	4"	8 1/2"	48"	20 1/2"	19"
BCFW48SP	48"	4 1/2"	52 1/2"	18"	3 1/4"	7 3/4"	4"	8 1/2"	48"	20 1/2"	19"

*Minimum/maximum space between inside edge of door and face of filler/adjoining cabinet. If cabinet is pulled to maximum stated dimension, filler will need to be cleated for proper attachment.

**When using hardware on cabinet doors/drawers, additional clearance may be needed.

BASE CORNER

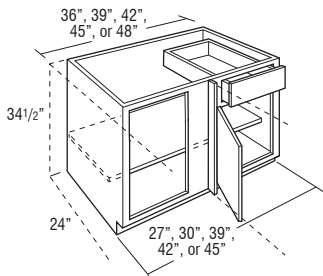

	Price Point	1	2	3	4	5	6	7	8	9	10	11	12
BC36 L or R		1027	1081	1093	1105	1118	1129	1192	1234	1279	1323	1359	1465
BC39 L or R		1077	1139	1159	1178	1197	1216	1284	1333	1381	1425	1464	1581
BC42 L or R		1124	1189	1219	1248	1277	1305	1378	1430	1484	1533	1572	1699
BC45 L or R		1151	1216	1249	1281	1314	1345	1422	1477	1534	1584	1627	1756
BC48 L or R		1173	1242	1279	1316	1353	1389	1469	1522	1583	1634	1677	1811

- On void side, do not install next to an appliance deeper than standard cabinet depth due to clearance needed for the door and drawer.
- Includes one 3" filler, shipped unattached.
- L or R indicates void. L (left) void shown.
- Adjustable 15" deep shelves.

Custom Modifications

AUTH	CBO	CCO	CFNTO	CFP	CFRMO	CH	CMAT	CND	CW	DRT	DRWPWR	DRWSEC	DRWTK	DRWWRM	EXBK	EX	FB	FD	FFD	FPFB	FTK	FTK_V	ID	INVFRM	MIP	P	PTOWB	RD	RECTK	RT	SCPDRW	TD	TOTSSS	TVR	V	VTK
•	•	•	•	•	•	•	•	•	•	•	• ²	• ³			•	•	•	•	• ⁴	•	•				•			•	•							•

Construction Upgrades

APC	ET	PE
•	•	•

Door Options

DPSRR
•

¹ Width reduction is taken from door section and does not affect corner void or clearance dimensions. Not available on BC36.

² Not available on BC36, BC39, and BC42

³ Available only on BC45

⁴ Face Frame and Door on End modification not available on the void side of the cabinet.

	Price Point	1	2	3	4	5	6	7	8	9	10	11	12
BASE CORNER with PULL-OUT	BC45PO L or R	3021	3086	3119	3151	3184	3215	3292	3347	3404	3454	3497	3626
	BC48PO L or R	3043	3112	3149	3186	3223	3259	3339	3392	3453	3504	3547	3681

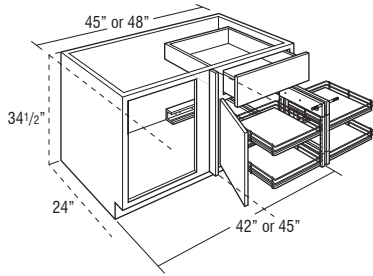

- On pull-out side of cabinet, do not install next to a wall or appliance due to clearance needed for pull-out to come out of cabinet. On void side, do not install next to an appliance deeper than standard cabinet depth due to clearance needed for door to open fully to allow pull-out to be used and also for the drawer to open fully.
- Pull-out features four wood shelves with chrome surround. Soft-close not available.
- Includes one 3" filler, shipped unattached.
- L or R indicates void. L (left) void shown.
- Adjacent cabinet hardware may interfere with shelf position on pull-out.
- Wire pull-out dimensions are 10 5/8" W x 17 1/8" D x 2 3/4" H.
- For pull-out to open, 10" of adjacent space is required with no obstruction beyond 1" in front of the cabinet face frame.

Custom Modifications

AUTH	CBO	CCO	CFNTO	CFP	CFRMO	CH	CMAT	CND	CW	DRT	DRWPWR	DRWSEC	DRWTK	DRWWRM	EXBK	EX	FB	FD	FFD	FPEB	FTK	FTK_V	ID	INVFRM	MIP	P	PTOWB	RD	RECTK	RT	SCPRW	TD	TOTSSS	TVR_V	VTK	
•	•	•	•	•	•	•	•	•	•	•	•	•	•	•	•	•	•	•	•	•	•	•	•	•	•	•	•	•	•	•	•	•	•	•	•	•

Construction Upgrades

APC	ET	PE
•	•	•

Door Options

DPSRR
•

BASE CORNER FULL WIDTH

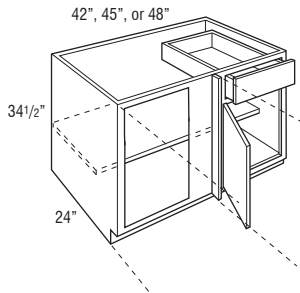
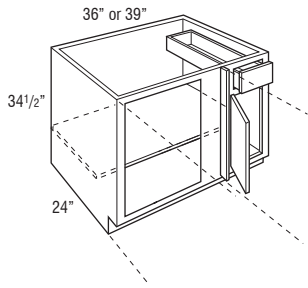

BCFW36 L or R	1109	1168	1194	1220	1245	1271	1341	1389	1439	1491	1527	1649
BCFW39 L or R	1148	1210	1240	1269	1299	1328	1403	1455	1510	1559	1599	1730

BCFW42 L or R	1185	1249	1282	1315	1347	1380	1463	1515	1572	1625	1667	1802
BCFW45 L or R	1216	1284	1318	1353	1388	1422	1505	1566	1621	1677	1721	1861
BCFW48 L or R	1247	1320	1357	1394	1431	1467	1553	1609	1668	1725	1772	1915

- On void side, do not install next to an appliance deeper than standard cabinet depth due to clearance needed for the door and drawer.
- Includes one 3" filler, shipped unattached.
- L or R indicates void. L (left) void shown.
- Adjustable 15" deep shelves.

Custom Modifications

AUTH	CBO	CCO	CFNTO	CFP	CFRMO	CH	CMAT	CND	CW	DRT	DRWPWR	DRWSEC	DRWTK	DRWWRM	EXBK	EX	FB	FD	FFD	FPEB	FTK	FTK_V	ID	INVFRM	MIP	P	PTOWB	RD	RECTK	RT	SCPRW	TD	TOTSSS	TVR_V	VTK	
•	•	•	•	•	•	•	•	•	•	• ¹	• ²	• ³	•	•	•	•	•	•	• ⁴	•	•	•	•	•	•	•	•	•	•	•	•	•	•	•	•	•

Construction Upgrades

APC	ET	PE
•	•	•

Door Options

DPSRR
•

¹ Width reduction is taken from door section and does not affect corner void or clearance dimensions. Not available on 36" wide.

² Not available on 36", 39", and 42" wide

³ Available only on 45" and 48" wide

⁴ Face Frame and Door on End modification not available on the void side of the cabinet.

BASE CORNER FULL WIDTH, FULL HEIGHT

36", 39", 42", 45", or 48"

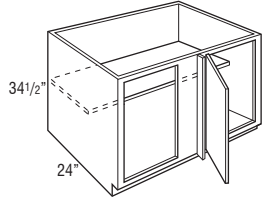

Price Point

	1	2	3	4	5	6	7	8	9	10	11	12
BCFW36FH L or R	914	974	1000	1026	1052	1076	1149	1193	1248	1299	1336	1456
BCFW39FH L or R	953	1016	1046	1075	1104	1133	1213	1259	1317	1368	1409	1538
BCFW42FH L or R	989	1054	1088	1120	1152	1185	1272	1319	1380	1434	1476	1609
BCFW45FH L or R	1020	1089	1123	1158	1193	1228	1315	1370	1428	1485	1531	1669
BCFW48FH L or R	1051	1126	1163	1200	1236	1272	1362	1415	1475	1533	1581	1723

- On void side, do not install next to an appliance deeper than standard cabinet depth due to clearance needed for the door.
- Includes one 3" filler, shipped unattached.
- L or R indicates void. L (left) void shown.
- Adjustable 15" deep shelves.

Custom Modifications

AUTH	CBO	CCO	CFNT0	CFP	CFRMO	CH	CMAT	CND	CW	DRT	DRWPWR	DRWSEC	DRWTK	DRWWRM	EXBK	EX	FB	FD	FFD	FPEB	FTK	FTK_V	ID	INVFRM	MIP	P	PTOWB	RD	RECTK	RT	SCPDRW	TD	TOTSSS	TVR_V	VTK
•	•	•	•	•	•	•	•	•	•	•	•	•	•	•	•	•	•	•	•	•	•	•	•	•	•	•	•	•	•	•	•	•	•	•	•

Construction Upgrades

APC	ET	PE
•	•	•

Door Options

DPSRR
•

¹ Width reduction is taken from door section and does not affect corner void or clearance dimensions. Not available on 36" wide.

² Face Frame and Door on End modification not available on the void side of the cabinet.

BASE CORNER FULL WIDTH with CURVED PULL-OUT

48"

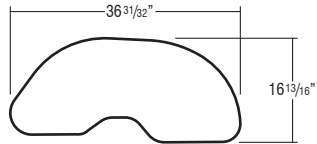
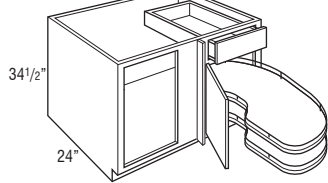

BCFW48CPO L or R	4233	4306	4343	4380	4417	4453	4539	4595	4654	4711	4758	4901
------------------	------	------	------	------	------	------	------	------	------	------	------	------

- On void side, do not install next to an appliance deeper than standard cabinet depth due to clearance needed for the door and drawer.
- Includes one 3" filler, shipped unattached.
- Includes two pull-out shelves with chrome wire surround and soft-close closing mechanism. Shelf height can be adjusted in the field.
- When shelf is fully opened, it extends 27 3/4" from front edge of the face frame. Unit pulls out to the front only and can be installed next to a wall or appliance without side interference.
- Distance from surface of shelf to top edge of wire surround is 1 11/16".
- L or R indicates void. L (left) void shown.
- Maximum Weight Capacity: 44 lbs. per shelf.
- Adjacent cabinet hardware may interfere with adjustable shelf position on pull-out.

Custom Modifications

AUTH	CBO	CCO	CFNT0	CFP	CFRMO	CH	CMAT	CND	CW	DRT	DRWPWR	DRWSEC	DRWTK	DRWWRM	EXBK	EX	FB	FD	FFD	FPEB	FTK	FTK_V	ID	INVFRM	MIP	P	PTOWB	RD	RECTK	RT	SCPDRW	TD	TOTSSS	TVR_V	VTK
•	•	•	•	•	•	•	•	•	•	•	•	•	•	•	•	•	•	•	•	•	•	•	•	•	•	•	•	•	•	•	•	•	•	•	

Construction Upgrades

APC	ET	PE
•	•	•

Door Options

DPSRR
•

BASE CORNER FULL WIDTH with PULL-OUT

45" or 48"

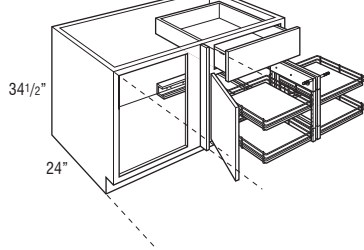

BCFW45PO L or R	3086	3154	3188	3223	3258	3292	3375	3436	3491	3547	3591	3731
BCFW48PO L or R	3117	3190	3227	3264	3301	3337	3423	3479	3538	3595	3642	3785

- On pull-out side of cabinet, do not install next to a wall or appliance due to clearance needed for pull-out to come out of cabinet. On void side, do not install next to an appliance deeper than standard cabinet depth due to clearance needed for door to open fully to allow pull-out to be used and also for the drawer to open fully.
- Includes one 3" filler, shipped unattached.
- L or R indicates void. L (left) void shown.
- Pull-out features four wood shelves with chrome surround. Soft-close not available.
- Wire pull-out interior dimensions are 10 5/8" W x 17 1/8" D x 2 3/4" H.
- For pull-out to open, 10" of adjacent space is required with no obstruction beyond 1" in front of the cabinet face frame.
- Adjacent cabinet hardware may interfere with shelf position on pull-out.

Custom Modifications

AUTH	CBO	CCO	CFNT0	CFP	CFRMO	CH	CMAT	CND	CW	DRT	DRWPWR	DRWSEC	DRWTK	DRWWRM	EXBK	EX	FB	FD	FFD	FPEB	FTK	FTK_V	ID	INVFRM	MIP	P	PTOWB	RD	RECTK	RT	SCPDRW	TD	TOTSSS	TVR_V	VTK
•	•	•	•	•	•	•	•	•	•	•	•	•	•	•	•	•	•	•	•	•	•	•	•	•	•	•	•	•	•	•	•	•	•	•	

Construction Upgrades

APC	ET	PE
•	•	•

Door Options

DPSRR
•

BASE CORNER FULL WIDTH with ROLL TRAYS & SWING-OUT

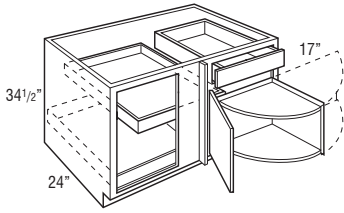

BCFW48SP L or R	2256	2377	2410	2444	2477	2510	2658	2757	2864	2965	3043	3292
------------------------	------	------	------	------	------	------	------	------	------	------	------	------

- On swing-out side of cabinet, do not install next to a wall or appliance due to clearance needed for swing-out to come out of cabinet and allow full access to other contents inside of cabinet. On void side, do not install next to an appliance deeper than standard cabinet depth due to clearance needed for door to open fully to allow swing-out to be used and also for the drawer to open fully.
- Includes one 3" filler, shipped unattached.
- L or R indicates void. L (left) void shown.
- Swing-out hinged opposite door.
- Roll trays and swing-outs installed.
- Insert swing on a base corner full width cabinet is 17".
- Swing-out is 3/4" laminated furniture board.

Custom Modifications

AUTH	CBO	CCO	CFNTO	CFP	CFRMO	CH	CMAT	CND	CW	DRT	DRWPWR	DRWSEC	DRWTK	DRWWRM	EXBK	EX	FB	FD	FFD	FPEB	FTK	FTK_V	ID	INVFRM	MIP	P	PTOWB	RD	RECTK	RT	SCPDRW	TD	TOTSSS	TVR_V	VTK		
•	•	•	•	•	•	•	•	•	•	•	•	•	•	•	•	•	•	•	•	•	•	•	•	•	•	•	•	•	•	•	•	•	•	•	•	•	•

Construction Upgrades

APC	ET	PE
•	•	•

Door Options

DPSRR
•

BASE LAZY SUSAN CORNER with FULL HEIGHT DOOR and LAZY SUSAN (With Center Hinge Door)

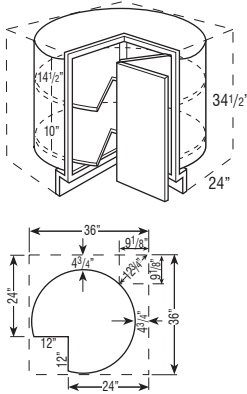

BLS36 L or R	1180	1259	1331	1402	1474	1544	1639	1704	1772	1837	1888	2045
---------------------	------	------	------	------	------	------	------	------	------	------	------	------

- BLS36 L or R wall width is 36" x 36".
- Cabinet is drum-shaped; adjoining cabinets create sides.
- BLS white plastic shelves are 28" diameter with a chrome pole.
- See Panels & Skins section for BLS BEP if used at end of cabinet run.
- Drum diameter is 31 1/8" and composed of 1/8" thick hardboard.
- Decorative hardware screws must be countersunk to prevent scratching of adjacent cabinets and face frame of BLS.
- Integrated soft-close hinge not included.

Custom Modifications

AUTH	CBO	CCO	CFNTO	CFP	CFRMO	CH	CMAT	CND	CW	DRT	DRWPWR	DRWSEC	DRWTK	DRWWRM	EXBK	EX	FB	FD	FFD	FPEB	FTK	FTK_V	ID	INVFRM	MIP	P	PTOWB	RD	RECTK	RT	SCPDRW	TD	TOTSSS	TVR_V	VTK		
•	•	•	•	•	•	•	•	•	•	•	•	•	•	•	•	•	•	•	•	•	•	•	•	•	•	•	•	•	•	•	•	•	•	•	•	•	•

Construction Upgrades

APC	ET	PE
•	•	•

Door Options

DPSRR
•

DIAGONAL BASE with FULL HEIGHT DOOR

DAB36FS L or R

1471	1606	1677	1746	1816	1885	1995	2073	2154	2233	2292	2480
------	------	------	------	------	------	------	------	------	------	------	------

- One fixed 1/2" thick shelf.
- Full overlay styles use the same width doors as partial overlay styles (14 1/2" wide) with a partial overlay hinge (38NPOHINGE) to allow for proper door clearance with adjacent cabinets.

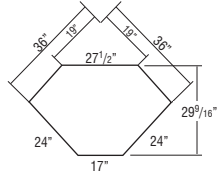
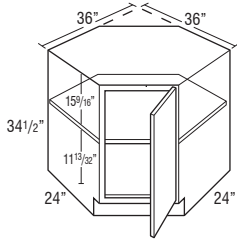

Custom Modifications

AUTH	CBO	CCO	CFNTO	CFP	CFRMO	CH	CMAT	CND	CW	DRT	DRWPWR	DRWSEC	DRWTK	DRWWRM	EXBK	EX	FB	FD	FFD	FPEB	FTK	FTK_V	ID	INVFRM	MIP	P	PTOWB	RD	RECTK	RT	SCPDRW	TD	TOTSSS	TVR_V	VTK		
•	•	•	•	•	•	•	•	•	•	•	•	•	•	•	•	•	•	•	•	•	•	•	•	•	•	•	•	•	•	•	•	•	•	•	•	•	•

Construction Upgrades

APC	ET	PE
•	•	•

Door Options

DPSRR
•

DIAGONAL BASE with FULL HEIGHT DOOR & SUPER LAZY SUSAN

DAB36SLS L or R

1960	2094	2163	2231	2299	2368	2479	2563	2641	2716	2775	2964
------	------	------	------	------	------	------	------	------	------	------	------

- Features two 28" plywood susans with a 1" plywood lip. Lower susan is mounted to floor. Upper susan is mounted to fixed shelf. Fixed shelf is 1/2" thick laminated furniture board.
- Full overlay styles use the same width doors as partial overlay styles (14 1/2" wide) with a partial overlay hinge (38NPOHINGE) to allow for proper door clearance with adjacent cabinets.

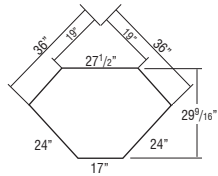
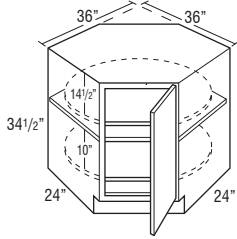

Due to fixed shelf mounting, susans cannot be retrofitted.

Custom Modifications

AUTH	CBO	CCO	CFNTO	CFP	CFRMO	CH	CMAT	CND	CW	DRT	DRWPWR	DRWSEC	DRWTK	DRWWRM	EXBK	EX	FB	FD	FFD	FPEB	FTK	FTK_V	ID	INVFRM	MIP	P	PTOWB	RD	RECTK	RT	SCPDRW	TD	TOTSSS	TVR_V	VTK		
•	•	•	•	•	•	•	•	•	•	•	•	•	•	•	•	•	•	•	•	•	•	•	•	•	•	•	•	•	•	•	•	•	•	•	•	•	•

Construction Upgrades

APC	ET	PE
•	•	•

Door Options

DPSRR
•

BASE EASY REACH

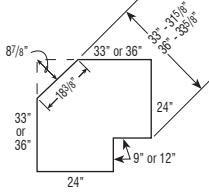
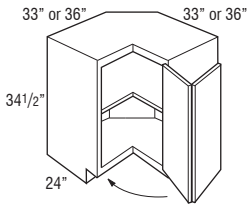

BER33 L or R	1180	1259	1331	1402	1474	1544	1639	1704	1772	1837	1888	2045
BER36 L or R	1180	1259	1331	1402	1474	1544	1639	1704	1772	1837	1888	2045

- BER33 L or R wall width is 33" x 33". BER36 L or R wall width is 36" x 36".
- Decorative hardware screws must be countersunk to prevent scratching of adjacent cabinets and face frame of BER.
- Fixed shelf is 1/2" thick laminated furniture board.
- Integrated soft-close hinge not included.

Custom Modifications

AUTH	CBO	CCO	CFNTO	CFP	CFRMO	CH	CMAT	CND	CW	DRT	DRWPWR	DRWSEC	DRWTK	DRWWRM	EXBK	EX	FB	FD	FFD	FPEB	FTK	FTK V	ID	INVFRM	MIP	P	PTOWB	RD	RECTK	RT	SCDRW	TD	TOTSSS	TVR	V	VTK		
•	•	•															•			•					•													•

Construction Upgrades

APC	ET	PE
•		•

Door Options

DPSRR
•

BASE EASY REACH with ADJUSTABLE SHELVES

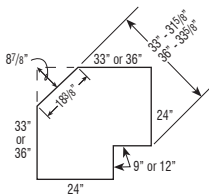
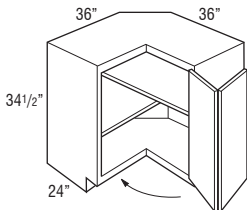
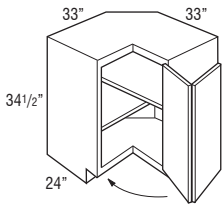

BERAS33 L or R	1215	1294	1366	1437	1509	1579	1674	1739	1807	1872	1923	2080
BERAS36 L or R	1215	1294	1366	1437	1509	1579	1674	1739	1807	1872	1923	2080

- BERAS33 L or R wall width is 33" x 33". BERAS36 L or R wall width is 36" x 36".
- Decorative hardware screws must be countersunk to prevent scratching of adjacent cabinets and face frame of BERAS.
- Adjustable crisscross shelves.
- Integrated soft-close hinge not included.

Custom Modifications

AUTH	CBO	CCO	CFNTO	CFP	CFRMO	CH	CMAT	CND	CW	DRT	DRWPWR	DRWSEC	DRWTK	DRWWRM	EXBK	EX	FB	FD	FFD	FPEB	FTK	FTK V	ID	INVFRM	MIP	P	PTOWB	RD	RECTK	RT	SCDRW	TD	TOTSSS	TVR	V	VTK		
•	•	•															•			•					•													•

Construction Upgrades

APC	ET	PE
•		•

Door Options

DPSRR
•

Price Point

1 2 3 4 5 6 7 8 9 10 11 12

ASYMMETRICAL BASE EASY REACH

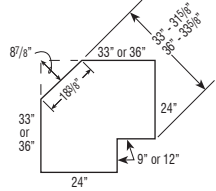
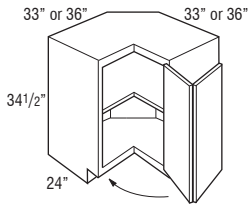

BER3336 L or R	1180	1259	1331	1402	1474	1544	1639	1704	1772	1837	1888	2045
BER3633 L or R	1180	1259	1331	1402	1474	1544	1639	1704	1772	1837	1888	2045

- BER3336 L or R wall width is 33" x 36".
- BER3633 L or R wall width is 36" x 33".
- Legs at the front frames are 9" on 33" and 12" on 36" leg.
- Nomenclature for asymmetrical cabinets reads as follows:
First set of numbers = left side of cabinet dimensions.
Second set of numbers = right side of cabinet dimensions.
- Decorative hardware screws must be countersunk to prevent scratching of adjacent cabinets and face frame of BER.
- Fixed shelf is 1/2" thick laminated furniture board.
- Integrated soft-close hinge not included.

Custom Modifications

AUTH	CBO	CCO	CFNTO	CFP	CFRMO	CH	CMAT	CND	CW	DRT	DRWPWR	DRWSEC	DRWTK	DRWWRM	EXBK	EX	FB	FD	FFD	FPEB	FTK	FTK_V	ID	INVFRM	MIP	P	PTOWB	RD	RECTK	RT	SCPDWR	TD	TOTSSS	TVR	V	VTK		
•	•	•				•												•			•					•												•

Construction Upgrades

APC	ET	PE
•		•

Door Options

DPSRR
•

ASYMMETRICAL BASE EASY REACH with ADJUSTABLE SHELVES

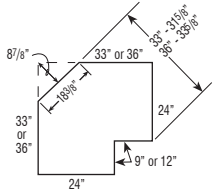
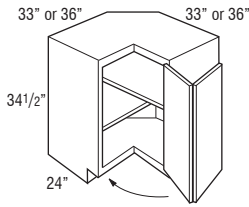

BERAS3336 L or R	1215	1294	1366	1437	1509	1579	1674	1739	1807	1872	1923	2080
BERAS3633 L or R	1215	1294	1366	1437	1509	1579	1674	1739	1807	1872	1923	2080

- BERAS3336 L or R wall width is 33" x 36".
- BERAS3633 L or R wall width is 36" x 33".
- Legs at the front frames are 9" on 33" and 12" on 36" leg.
- Nomenclature for asymmetrical cabinets reads as follows:
First set of numbers = left side of cabinet dimensions.
Second set of numbers = right side of cabinet dimensions.
- Decorative hardware screws must be countersunk to prevent scratching of adjacent cabinets and face frame of BERAS.
- Adjustable crisscross shelves.
- Integrated soft-close hinge not included.

Custom Modifications

AUTH	CBO	CCO	CFNTO	CFP	CFRMO	CH	CMAT	CND	CW	DRT	DRWPWR	DRWSEC	DRWTK	DRWWRM	EXBK	EX	FB	FD	FFD	FPEB	FTK	FTK_V	ID	INVFRM	MIP	P	PTOWB	RD	RECTK	RT	SCPDWR	TD	TOTSSS	TVR	V	VTK		
•	•	•				•												•			•					•												•

Construction Upgrades

APC	ET	PE
•		•

Door Options

DPSRR
•

SUPER LAZY SUSAN

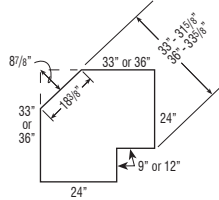
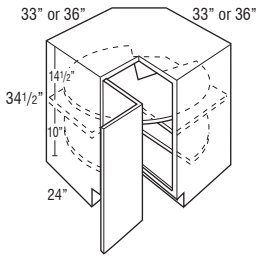

Due to fixed shelf mounting, susans cannot be retrofitted.

Custom Modifications

AUTH	CBO	CCO	CFNTO	CFP	CFRMO	CH	CMAT	CND	CW	DRT	DRWPWR	DRWSEC	DRWTK	DRWWRM	EXBK	EX	FB	FD	FFD	FPEB	FTK	FTK_V	ID	INVFRM	MIP	P	PTOWB	RD	RECTK	RT	SCPDRW	TD	TOTSSS	TVR_V	VTK			

Construction Upgrades

APC	ET	PE

Door Options

DPSRR

Price Point	1	2	3	4	5	6	7	8	9	10	11	12
SLS33 L or R	2082	2225	2351	2476	2602	2727	2893	3006	3126	3240	3329	3605
SLS36 L or R	2216	2369	2503	2636	2771	2904	3080	3196	3326	3451	3537	3834

- SLS33 L or R wall width is 33" x 33".
- SLS36 L or R wall width is 36" x 36".
- SLS33 - Susans are 28" diameter.
- SLS36 - Susans are 32" diameter.
- Features two plywood susans with a 1" plywood lip. Lower susan is mounted to floor. Upper susan is mounted to fixed shelf. Fixed shelf is 1/2" thick laminated furniture board.
- Decorative hardware screws must be countersunk to prevent scratching adjacent cabinets and face frame of SLS.
- Integrated soft-close hinge not included.

SOLID-WOOD SUPER LAZY SUSAN

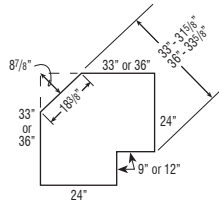
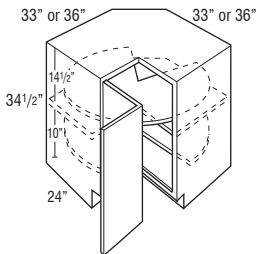

Due to fixed shelf mounting, susans cannot be retrofitted.

Custom Modifications

AUTH	CBO	CCO	CFNTO	CFP	CFRMO	CH	CMAT	CND	CW	DRT	DRWPWR	DRWSEC	DRWTK	DRWWRM	EXBK	EX	FB	FD	FFD	FPEB	FTK	FTK_V	ID	INVFRM	MIP	P	PTOWB	RD	RECTK	RT	SCPDRW	TD	TOTSSS	TVR_V	VTK		

Construction Upgrades

APC	ET	PE

Door Options

DPSRR

SLSW33 L or R	2601	2784	2941	3097	3254	3409	3615	3758	3910	4051	4159	4506
SLSW36 L or R	2772	2960	3128	3295	3463	3630	3849	3996	4156	4314	4421	4795

- SLSW33 L or R wall width is 33" x 33".
- SLSW36 L or R wall width is 36" x 36".
- SLSW33 L or R - Susans are 28" diameter.
- SLSW36 L or R - Susans are 32" diameter.
- Features two hardwood susans with a 3/16" lip. Lower susan is mounted to floor. Upper susan is mounted to fixed shelf. Fixed shelf is 1/2" thick laminated furniture board.
- Decorative hardware screws must be countersunk to prevent scratching adjacent cabinets and face frame of SLS.
- Integrated soft-close hinge not included.

Price Point

1 2 3 4 5 6 7 8 9 10 11 12

SUPER LAZY SUSAN with CHROME RAIL

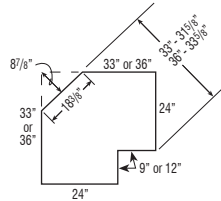
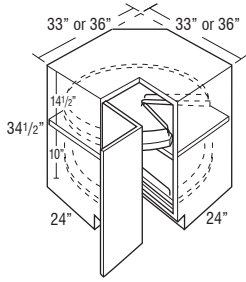

Due to fixed shelf mounting, susans cannot be retrofitted.

SLS33 L or R	2386	2529	2655	2780	2906	3031	3197	3310	3430	3544	3633	3909
SLS36 L or R	2520	2673	2807	2940	3075	3208	3384	3500	3630	3755	3841	4138

- SLS33 L or R wall width is 33" x 33". SLS36 L or R wall width is 36" x 36".
- SLS33 - Susans are 28" diameter. SLS36 - Susans are 32" diameter.
- Features two plywood susans with a 1" plywood lip. Lower susan is mounted to floor. Upper susan is mounted to fixed shelf. Fixed shelf is 1/2" thick laminated furniture board.
- Chrome rail surrounds both susans. Chrome rail height is 2 13/16".
- Decorative hardware screws must be countersunk to prevent scratching adjacent cabinets and face frame of SLS3R.
- Integrated soft-close hinge not included.

Custom Modifications

AUTH	CBO	CCO	CFNTD	CFP	CFRMO	CH	CMAT	CND	CW	DRT	DRWPWR	DRWSEC	DRWTK	DRWWRM	EXBK	EX	FB	FD	FFD	FPEB	FTK	FTK_V	ID	INVFRM	MIP	P	PTOWB	RD	RECTK	RT	SCPDRW	TD	TOTSSS	TVR	V	VTK		

Construction Upgrades

APC	ET	PE

Door Options

DPSRR

ASYMMETRICAL SUPER LAZY SUSAN

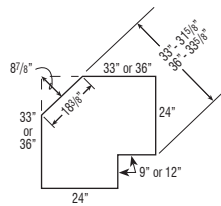
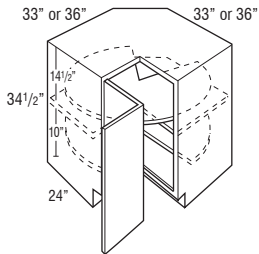

Due to fixed shelf mounting, susans cannot be retrofitted.

SLS3336 L or R	2216	2369	2503	2636	2771	2904	3080	3196	3326	3451	3537	3834
SLS3633 L or R	2216	2369	2503	2636	2771	2904	3080	3196	3326	3451	3537	3834

- SLS3336 L or R wall width is 33" x 36".
- SLS3633 L or R wall width is 36" x 33".
- All Asymmetrical Super Susan shelves are 28" diameter.
- Features two plywood susans with a 1" plywood lip. Lower susan is mounted to floor. Upper susan is mounted to fixed shelf. Fixed shelf is 1/2" thick laminated furniture board.
- Nomenclature for asymmetrical cabinets reads as follows:
 First set of numbers = left side of cabinet dimensions.
 Second set of numbers = right side of cabinet dimensions.
- Decorative hardware screws must be countersunk to prevent scratching adjacent cabinets and face frame of SLS.
- Integrated soft-close hinge not included.

Custom Modifications

AUTH	CBO	CCO	CFNTD	CFP	CFRMO	CH	CMAT	CND	CW	DRT	DRWPWR	DRWSEC	DRWTK	DRWWRM	EXBK	EX	FB	FD	FFD	FPEB	FTK	FTK_V	ID	INVFRM	MIP	P	PTOWB	RD	RECTK	RT	SCPDRW	TD	TOTSSS	TVR	V	VTK		

Construction Upgrades

APC	ET	PE

Door Options

DPSRR

ASYMMETRICAL SOLID-WOOD SUPER LAZY SUSAN

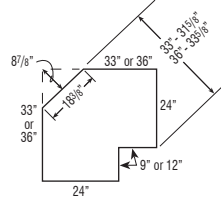
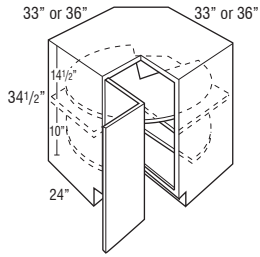

Due to fixed shelf mounting, susans cannot be retrofitted.

Custom Modifications

AUTH	CBO	CCO	CFNTO	CFP	CFRMO	CH	CMAT	CND	CW	DRT	DRWPWR	DRWSEC	DRWTK	DRWWRM	EXBK	EX	FB	FD	FFD	FPEB	FTK	FTK_V	ID	INVFRM	MIP	P	PTOWB	RD	RECTK	RT	SCPDRW	TD	TOTSSS	TVR_V	VTK				

Construction Upgrades

APC	ET	PE

Door Options

DPSRR

Price Point	1	2	3	4	5	6	7	8	9	10	11	12
SLSW3336 L or R	2772	2960	3128	3295	3463	3630	3849	3996	4156	4314	4421	4795
SLSW3633 L or R	2772	2960	3128	3295	3463	3630	3849	3996	4156	4314	4421	4795

- SLSW3336 L or R wall width is 33" x 36".
- SLSW3633 L or R wall widths is 36" x 33".
- All Asymmetrical Super Susans shelves are 28" diameter.
- Features two hardwood susans with a 3/16" lip. Lower susan is mounted to floor. Upper susan is mounted to fixed shelf. Fixed shelf is 1/2" thick laminated furniture board.
- Nomenclature for asymmetrical cabinets reads as follows:
First set of numbers = left side of cabinet dimensions.
Second set of numbers = right side of cabinet dimensions.
- Decorative hardware screws must be countersunk to prevent scratching adjacent cabinets and face frame of SLS.
- Integrated soft-close hinge not included.

ASYMMETRICAL SUPER LAZY SUSAN with CHROME RAIL

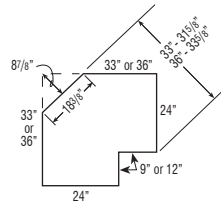
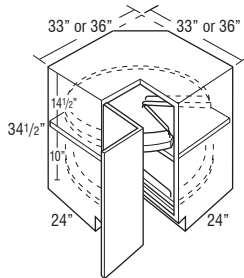

Due to fixed shelf mounting, susans cannot be retrofitted.

Custom Modifications

AUTH	CBO	CCO	CFNTO	CFP	CFRMO	CH	CMAT	CND	CW	DRT	DRWPWR	DRWSEC	DRWTK	DRWWRM	EXBK	EX	FB	FD	FFD	FPEB	FTK	FTK_V	ID	INVFRM	MIP	P	PTOWB	RD	RECTK	RT	SCPDRW	TD	TOTSSS	TVR_V	VTK			

Construction Upgrades

APC	ET	PE

Door Options

DPSRR

SLSLR3336 L or R	2520	2673	2807	2940	3075	3208	3384	3500	3630	3755	3841	4138
SLSLR3633 L or R	2520	2673	2807	2940	3075	3208	3384	3500	3630	3755	3841	4138

- SLSLR3336 L or R wall width is 33" x 36".
- SLSLR3633 L or R wall width is 36" x 33".
- All Asymmetrical Super Susans shelves are 28" diameter.
- Features two plywood susans with a 1" plywood lip. Lower susan is mounted to floor. Upper susan is mounted to fixed shelf. Fixed shelf is 1/2" thick laminated furniture board.
- Chrome rail surrounds both susans. Chrome rail height is 2 13/16".
- Nomenclature for asymmetrical cabinets reads as follows:
First set of numbers = left side of cabinet dimensions.
Second set of numbers = right side of cabinet dimensions.
- Decorative hardware screws must be countersunk to prevent scratching adjacent cabinets and face frame of SLS.
- Integrated soft-close hinge not included.

BASE ROTATING DEEP BIN

BRDB36 L or R

2882	3032	3164	3296	3428	3560	3737	3863	3991	4108	4196	4493
------	------	------	------	------	------	------	------	------	------	------	------

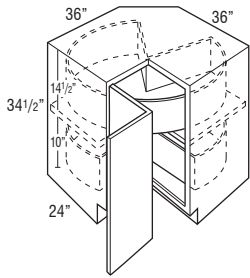

- BRDB36 wall width is 36" x 36".
- BRDB36 susans are 30" diameter. Bins are 6" deep.
- Inside bottom of lower deep susan to the fixed shelf is 10" high.
- Inside bottom of upper deep susan to the bottom of face frame cross rail is 14 1/8" high.
- Lower susan is mounted to floor. Upper susan is mounted to fixed shelf. Fixed shelf is 1/2" thick laminated furniture board.
- Decorative hardware screws must be countersunk to prevent scratching of adjacent cabinets and face frame of BRDB.
- Integrated soft-close hinge not included.

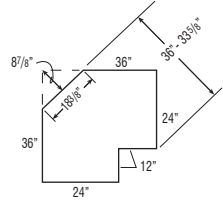

Due to fixed shelf mounting, susans cannot be retrofitted.

Custom Modifications

AUTH	CBO	CCO	CFNTO	CFP	CFRMO	CH	CMAT	CND	CW	DRT	DRWPWR	DRWSEC	DRWTK	DRWWRM	EXBK	EX	FB	FD	FFD	FPEB	FTK	FTK_V	ID	INVFRM	MIP	P	PTOWB	RD	RECTK	RT	SCPDWR	TD	TOTSSS	TVR	V	VTK		

Construction Upgrades

APC	ET	PE

Door Options

DPSRR

LAZY SUSAN PULL-OUT

LSP36 L or R

3926	4005	4077	4148	4220	4290	4385	4450	4518	4583	4634	4791
------	------	------	------	------	------	------	------	------	------	------	------

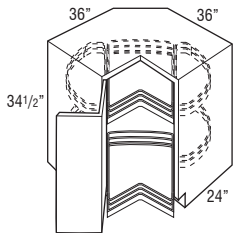

- LSP36 L or R wall width is 36" x 36".
- Features four half-moon bins (8 3/8" x 25 1/2" each) with plywood shelves and chrome rail sides.
- Center pull-outs have soft-close guides and operate independently. Entire unit rotates when center pull-outs are in closed position.
- Decorative hardware screws must be countersunk to prevent scratching adjacent cabinets and face frame of LSP.
- Integrated soft-close hinge not included.

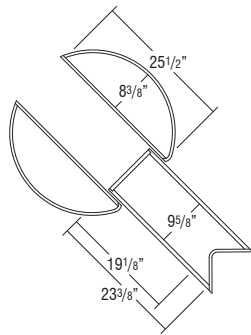
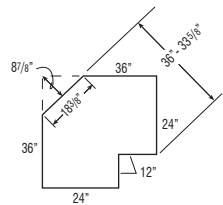

Custom Modifications

AUTH	CBO	CCO	CFNTO	CFP	CFRMO	CH	CMAT	CND	CW	DRT	DRWPWR	DRWSEC	DRWTK	DRWWRM	EXBK	EX	FB	FD	FFD	FPEB	FTK	FTK_V	ID	INVFRM	MIP	P	PTOWB	RD	RECTK	RT	SCPDWR	TD	TOTSSS	TVR	V	VTK		

Construction Upgrades

APC	ET	PE

Door Options

DPSRR

1	2	3	4	5	6	7	8	9	10	11	12
---	---	---	---	---	---	---	---	---	----	----	----

THREE DRAWER CORNER CABINET

3CDB36

- Must be installed between 2 cabinets.
- Allow for proper clearance of drawer head when specifying corner drawer cabinets next to appliances.
- Will have less than 3/4" overlay side reveal for clearance purposes.
- Cabinet sides will always be Natural Maple laminate. If PE or APC is specified, cabinet sides will be unfinished.
- Exterior height of bottom 2 drawer boxes is 7 3/8".

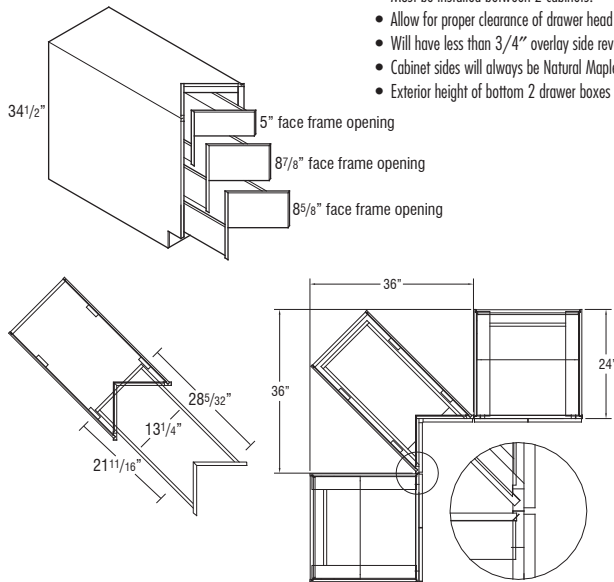

A Dimension	B Dimension
24"*	0"
25"	3/4"
26"	1 3/4"
27"	2 3/4"
28"	3 3/4"
29"	4 3/4"
30"	5 3/4"

A indicates depth of adjacent appliance or cabinet.
 B indicates minimum space needed between appliance/deeper cabinet and corner drawer base to ensure proper operation of drawers.
 *Standard depth cabinet (24") does not require filler.

Custom Modifications

AUTH	CBO	CCO	CFNTO	CFP	CFRMO	CH	CMAT	CND	CW	DRT	DRWPWR	DRWSEC	DRWTK	DRWWRM	EXBK	EX	FB	FD	FFD	FPEB	FTK	FTK_V	ID	INVFRM	MIP	P	PTOWB	RD	RECTK	RT	SCDRW	TD	TOTSS	TVR_V	VTK		

Construction Upgrades

APC	ET	PE

Door Options

DPSRR

BASE TRANSITION CABINET

BTC12LL

BTC12RL

BTC12LR

BTC12RR

750	754	775	795	815	836	885	923	962	990	1020	1105
750	754	775	795	815	836	885	923	962	990	1020	1105
750	754	775	795	815	836	885	923	962	990	1020	1105
750	754	775	795	815	836	885	923	962	990	1020	1105

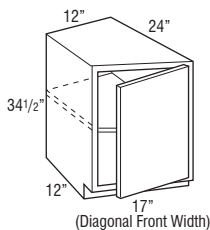

(Diagonal Front Width)

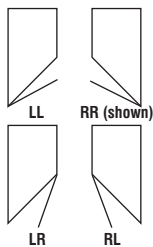

Hinging Options

Top View

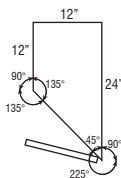

- One adjustable shelf.
- Cabinets constructed with top.
- Specify door hinging. RR shown.
- Depth can be reduced to a minimum of 18".
- RECTKBK, RECTKL and RECTKR cannot be ordered when RD is specified. RECTKL and RECTKR cannot be specified on the same cabinet.
- Full overlay styles use the same width doors as partial overlay styles (14 1/2" wide) with a partial overlay hinge (38NPOHINGE) to allow for proper door clearance with adjacent cabinets.

Custom Modifications

AUTH	CBO	CCO	CFNTO	CFP	CFRMO	CH	CMAT	CND	CW	DRT	DRWPWR	DRWSEC	DRWTK	DRWWRM	EXBK	EX	FB	FD	FFD	FPEB	FTK	FTK_V	ID	INVFRM	MIP	P	PTOWB	RD	RECTK	RT	SCDRW	TD	TOTSS	TVR_V	VTK	
• ¹																																				

Construction Upgrades

APC	ET	PE

Door Options

DPSRR

¹ Available only on 12" deep side of cabinet
² RECTKALL not available

135° CORNER OUTSIDE BASE

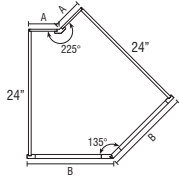
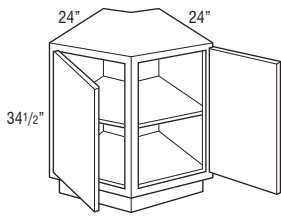

Price Point	1	2	3	4	5	6	7	8	9	10	11	12
BFH6COA	2256	2377	2410	2444	2477	2510	2658	2757	2864	2965	3043	3292
BFH9COA	2367	2495	2531	2566	2601	2635	2789	2895	3006	3114	3195	3456
BFH12COA	2479	2616	2653	2689	2725	2761	2922	3033	3151	3261	3347	3620

- Doors are hinged on outside of frame.
- Adjustable shelves cannot be removed from the cabinet.

Model	A Dimension	B Dimension
BFH6COA	6"	15 15/16"
BFH9COA	9"	18 15/16"
BFH12COA	12"	21 15/16"

A indicates back width of cabinet and wall space.
B indicates face frame width.

Custom Modifications

AUTH	CBO	CCO	CFNTO	CFP	CFRMO	CH	CMAT	CND	CW	DRT	DRWPWR	DRWSEC	DRWTK	DRWWRM	EXBK	EX	FB	FD	FFD	FPEB	FTK	FTK_V	ID	INVFRM	MIP	P	PTOWB	RD	RECTK	RT	SCPDWR	TD	TOTSSS	TVR	V	VTK	
•	•	•				•												•		•						•											•

Construction Upgrades

APC	ET	PE
•		•

Door Options

DPSRR
•

135° CORNER INSIDE BASE

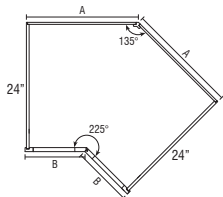
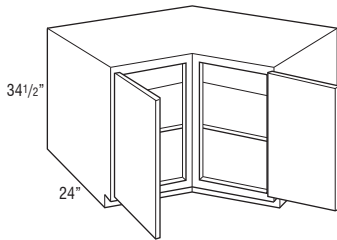

BFH21CIA	2256	2377	2410	2444	2477	2510	2658	2757	2864	2965	3043	3292
BFH24CIA	2367	2495	2531	2566	2601	2635	2789	2895	3006	3114	3195	3456
BFH27CIA	2479	2616	2653	2689	2725	2761	2922	3033	3151	3261	3347	3620

- Doors are hinged on outside of frame.
- Adjustable shelves cannot be removed from the cabinet.

Model	A Dimension	B Dimension
BFH21CIA	21"	11 3/32"
BFH24CIA	24"	14 3/32"
BFH27CIA	27"	17 3/32"

A indicates back width of cabinet and wall space.
B indicates face frame width.

Custom Modifications

AUTH	CBO	CCO	CFNTO	CFP	CFRMO	CH	CMAT	CND	CW	DRT	DRWPWR	DRWSEC	DRWTK	DRWWRM	EXBK	EX	FB	FD	FFD	FPEB	FTK	FTK_V	ID	INVFRM	MIP	P	PTOWB	RD	RECTK	RT	SCPDWR	TD	TOTSSS	TVR	V	VTK	
•	•	•				•												•		•						•											•

Construction Upgrades

APC	ET	PE
•		•

Door Options

DPSRR
•

BASE END CABINET

BEC24

Price Point

1	2	3	4	5	6	7	8	9	10	11	12
1047	1120	1189	1258	1327	1396	1477	1538	1598	1659	1699	1841

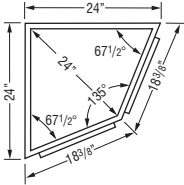
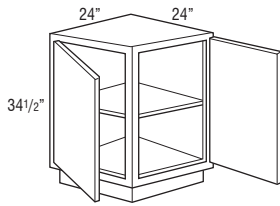

- Wall width is 24" x 24".
- 24" W x 24" D x 34 1/2" H.
- 24" from outside corner point to frame face.
- Cabinets constructed with top.
- One adjustable shelf.
- Cabinet may be installed against either end of a run.

Custom Modifications

AUTH	CBO	CCO	CFNTO	CFP	CFRMO	CH	CMAT	CND	CW	DRT	DRWPWR	DRWSEC	DRWTK	DRWWRM	EXBK	EX	FB	FD	FFD	FPEB	FTK	FTK_V	ID	INVFRM	MIP	P	PTOWB	RD	RECTK	RT	SCPDRW	TD	TOTSSS	TVR_V	VTK		
•	•				•																	•				•											•

Construction Upgrades

APC	ET	PE
•		

Door Options

DPSRR
•

TWO DRAWER BASE with FILE DRAWER

2DB24FD

1792	1801	1817	1832	1848	1863	1957	2028	2098	2159	2211	2378
------	------	------	------	------	------	------	------	------	------	------	------

2DB30FD

2125	2135	2250	2364	2479	2593	2725	2824	2915	3002	3079	3311
------	------	------	------	------	------	------	------	------	------	------	------

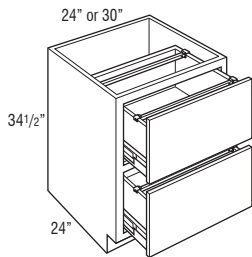

- Includes Filing System Hardware Kit, which accommodates letter and legal filing.
- Drawers utilize 125 lb. full extension progressive side-mount guide, does not feature soft-close guide.
- Depth can be reduced to a minimum of 21".
- Exterior drawer box height is 10".

Custom Modifications

AUTH	CBO	CCO	CFNTO	CFP	CFRMO	CH	CMAT	CND	CW	DRT	DRWPWR	DRWSEC	DRWTK	DRWWRM	EXBK	EX	FB	FD	FFD	FPEB	FTK	FTK_V	ID	INVFRM	MIP	P	PTOWB	RD	RECTK	RT	SCPDRW	TD	TOTSSS	TVR_V	VTK	
•	•	•			•								•		•	•					•	•	•						•	•						•

Construction Upgrades

APC	ET	PE
•		•

Door Options

DPSRR

TWO DRAWER BASE

18", 21", 24", 27", 30", 33", 36", 42", or 48"

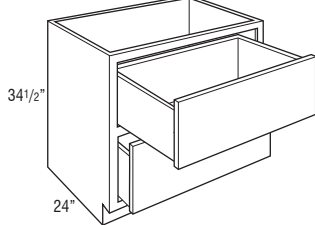

2DB18	1344	1351	1373	1396	1418	1440	1521	1583	1641	1700	1744	1891
2DB21	1409	1416	1445	1474	1503	1531	1621	1681	1746	1809	1854	2014
2DB24	1551	1559	1576	1592	1608	1624	1719	1786	1857	1922	1973	2140
2DB27	1718	1727	1793	1858	1924	1989	2102	2183	2266	2342	2406	2606
2DB30	1883	1892	2007	2122	2238	2353	2485	2582	2675	2763	2838	3072
2DB33	1929	1939	2069	2197	2326	2455	2595	2694	2791	2885	2961	3207
2DB36	1977	1987	2129	2271	2414	2556	2700	2801	2908	3008	3080	3338
2DB42	2537	2549	2700	2852	3003	3154	3308	3419	3534	3638	3715	3991
2DB48	2716	2729	2891	3052	3213	3375	3539	3659	3781	3891	3975	4268

- Exterior drawer box height is 10".
- When SCPDRW is selected, the top drawer will utilize a 6 3/8" high drawer box instead of the current 10" high drawer box, creating a clearance of 6 5/8" for the cooktop.

Custom Modifications

AUTH	CBO	CCO	CFNTO	CFP	CFRMO	CH	CMAT	CND	CW	DRT	DRWPWR	DRWSEC	DRWTK	DRWWRM	EXBK	EX	FB	FD	FFD	FPEB	FTK	FTK_V	ID	INVFRM	MIP	P	PTOWB	RD	RECTK	RT	SCPDRW	TD	TOTSSS	TVR_V	VTK	
•	•	•			•								• ¹		•	•					•	•	•					• ³	•		•					•

Construction Upgrades

APC	ET	PE
•		•

Door Options

DPSRR

¹ Not available on 18", 42", and 48" wide
² Not available on 42" and 48" wide
³ Depth can be reduced to a minimum of 21" on 42" and 48" wide cabinets

Price Point

1 2 3 4 5 6 7 8 9 10 11 12

TWO DRAWER BASE with PEGGED DISH ORGANIZER

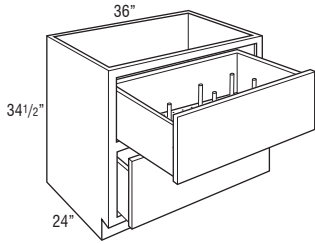

2DB36PDO

756	756	756	756	756	756	756	756	756	756	756	756	756
-----	-----	-----	-----	-----	-----	-----	-----	-----	-----	-----	-----	-----

- Includes 8 wooden pegs.
- Includes 19/32" thick removable pegged board in top drawer.
- Exterior drawer box height is 10".
- Pegs and pegged board available as accessories for field installation. See page 313.
- When SCPDRW is selected, the top drawer will utilize a 6 3/8" high drawer box instead of the current 10" high drawer box, creating a clearance of 6 5/8" for the cooktop.

Custom Modifications

AUTH	CBO	CCO	CFNTO	CFP	CFRMO	CH	CMAT	CND	CW	DRT	DRWPWR	DRWSEC	DRWTK	DRWWRM	EXBK	EX	FB	FD	FFD	FPEB	FTK	FTK_V	ID	INVFRM	MIP	P	PTOWB	RD	RECTK	RT	SCPDRW	TD	TOTSSS	TVR_V	VTK		
•	•	•											•			•	•				•	•	•							•		•					•

Construction Upgrades

APC	ET	PE
•		•

Door Options

DPSRR

TWO DRAWER BASE with ROLL TRAY

18", 21", 24", 27", 30", 33", or 36"

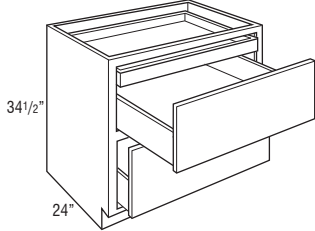

2DB18RT

1628	1635	1657	1680	1702	1724	1805	1867	1925	1984	2028	2175
------	------	------	------	------	------	------	------	------	------	------	------

2DB21RT

1693	1700	1729	1758	1787	1815	1905	1965	2030	2093	2138	2298
------	------	------	------	------	------	------	------	------	------	------	------

2DB24RT

1835	1843	1860	1876	1892	1908	2003	2070	2141	2206	2257	2424
------	------	------	------	------	------	------	------	------	------	------	------

2DB27RT

2002	2011	2077	2142	2208	2273	2386	2467	2550	2626	2690	2890
------	------	------	------	------	------	------	------	------	------	------	------

2DB30RT

2167	2176	2291	2406	2522	2637	2769	2866	2959	3047	3122	3356
------	------	------	------	------	------	------	------	------	------	------	------

2DB33RT

2213	2223	2353	2481	2610	2739	2879	2978	3075	3169	3245	3491
------	------	------	------	------	------	------	------	------	------	------	------

2DB36RT

2261	2271	2413	2555	2698	2840	2984	3085	3192	3292	3364	3622
------	------	------	------	------	------	------	------	------	------	------	------

- Exterior height of drawer boxes is 6 3/8".

Custom Modifications

AUTH	CBO	CCO	CFNTO	CFP	CFRMO	CH	CMAT	CND	CW	DRT	DRWPWR	DRWSEC	DRWTK	DRWWRM	EXBK	EX	FB	FD	FFD	FPEB	FTK	FTK_V	ID	INVFRM	MIP	P	PTOWB	RD	RECTK	RT	SCPDRW	TD	TOTSSS	TVR_V	VTK		
•	•	•								• ¹			•			•	•				•	•	•							•		•					•

Construction Upgrades

APC	ET	PE
•		•

Door Options

DPSRR

¹ Not available on 18" wide

TWO DRAWER BASE with ROLL TRAY and PEGGED DISH ORGANIZER

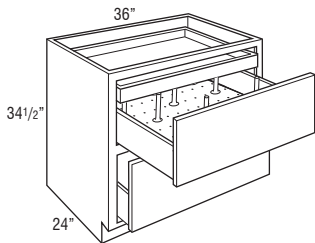

2DB36RTPDO

2579	2590	2732	2873	3014	3156	3299	3402	3509	3606	3680	3936
------	------	------	------	------	------	------	------	------	------	------	------

- Includes 8 wooden pegs.
- Includes 19/32" thick removable pegged board in top drawer.
- Pegs and pegged board available as accessories for field installation. See page 313.
- Exterior height of drawer boxes is 6 3/8".

Custom Modifications

AUTH	CBO	CCO	CFNTO	CFP	CFRMO	CH	CMAT	CND	CW	DRT	DRWPWR	DRWSEC	DRWTK	DRWWRM	EXBK	EX	FB	FD	FFD	FPEB	FTK	FTK_V	ID	INVFRM	MIP	P	PTOWB	RD	RECTK	RT	SCPDRW	TD	TOTSSS	TVR_V	VTK	
•	•	•											•			•	•				•	•	•						•		•					•

Construction Upgrades

APC	ET	PE
•		•

Door Options

DPSRR

TWO DRAWER BASE, DROP-IN RANGE

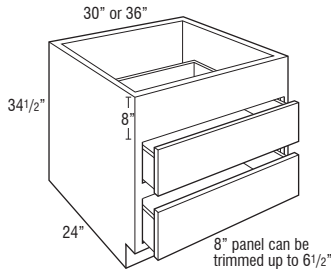

Price Point	1	2	3	4	5	6	7	8	9	10	11	12
2DB30DR	2155	2166	2300	2434	2567	2700	2850	2952	3058	3155	3236	3490
2DB36DR	2257	2268	2433	2596	2760	2923	3084	3194	3312	3422	3507	3783

- Exterior height of drawer boxes is 6 3/8".
- Drawer front and opening height will not change when CH is ordered.

Custom Modifications

AUTH	CBO	CCO	CFNTO	CFP	CFRMO	CH	CMAT	CND	CW	DRT	DRWPWR	DRWSEC	DRWTK	DRWWRM	EXBK	EX	FB	FD	FFD	FPEB	FTK	FTK_V	ID	INVFRM	MIP	P	PTOWB	RD	RECTK	RT	SCDRW	TD	TOTSSS	TVR_V	VTK	
•	•	•			•	•				•			•		•	•	•			•	•	•						•	•							•

Construction Upgrades

APC	ET	PE
•		•

Door Options

DPSRR

THREE DRAWER BASE

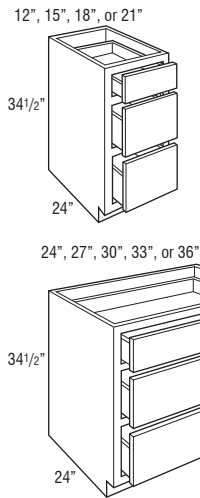

3DB12	1294	1300	1310	1320	1331	1341	1406	1453	1496	1540	1575	1693
3DB15	1351	1357	1369	1379	1390	1400	1467	1519	1568	1609	1645	1772
3DB18	1425	1431	1443	1454	1465	1475	1551	1603	1655	1702	1744	1876
3DB21	1499	1506	1520	1533	1547	1559	1636	1695	1752	1800	1841	1984
3DB24	1549	1557	1570	1584	1597	1611	1693	1755	1813	1869	1912	2062
3DB27	1652	1660	1681	1701	1721	1742	1840	1908	1978	2050	2109	2272
3DB30	1837	1846	1878	1911	1943	1976	2090	2169	2253	2332	2409	2593
3DB33	1914	1924	1967	2008	2050	2091	2211	2295	2386	2467	2542	2736
3DB36	1990	2000	2053	2104	2156	2208	2332	2420	2511	2601	2676	2882

- Exterior height of bottom 2 drawer boxes is 6 3/8".

Custom Modifications

AUTH	CBO	CCO	CFNTO	CFP	CFRMO	CH	CMAT	CND	CW	DRT	DRWPWR	DRWSEC	DRWTK	DRWWRM	EXBK	EX	FB	FD	FFD	FPEB	FTK	FTK_V	ID	INVFRM	MIP	P	PTOWB	RD	RECTK	RT	SCDRW	TD	TOTSSS	TVR_V	VTK	
•	•	•			•				• ¹		• ²	• ³	• ²	•	•	•				•	•	• ¹						•	•							•

Construction Upgrades

APC	ET	PE
•		•

Door Options

DPSRR

¹ Not available on 12" wide
² Not available on 12" and 15" wide
³ Available only on 18", 21", and 24" wide

THREE DRAWER BASE BUFFET

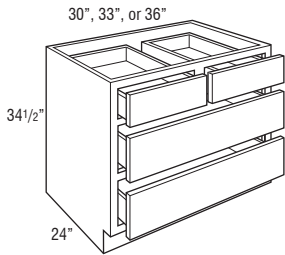

Price Point	1	2	3	4	5	6	7	8	9	10	11	12
3DBB30	2111	2121	2159	2197	2236	2272	2405	2495	2591	2682	2769	2979
3DBB33	2202	2213	2262	2311	2359	2407	2544	2639	2743	2836	2922	3149
3DBB36	2288	2299	2360	2420	2481	2540	2682	2784	2888	2990	3080	3314

• Exterior height of bottom 2 drawer boxes is 6 3/8".

Custom Modifications

AUTH	CBO	CCO	CFNTO	CFP	CFRMO	CH	CMAT	CND	CW	DRT	DRWPWR	DRWSEC	DRWTK	DRWWRM	EXBK	EX	FB	FD	FFD	FPEB	FTK	FTK_V	ID	INVFRM	MIP	P	PTOWB	RD	RECTK	RT	SCPDRW	TD	TOTSSS	TVR_V	VTK		
•	•	•	•	•	•	•	•	•	• ¹	•	• ²	• ²	•	•	•	•	•	•	•	•	•	•	•	•	•	•	•	•	•	•	•	•	•	•	•	•	•

Construction Upgrades

APC	ET	PE
•	•	•

Door Options

DPSRR

¹ Not available on 30" wide
² Not available on 30" and 33" wide

THREE DRAWER BASE with WOOD TIERED CUTLERY DIVIDER DRAWER

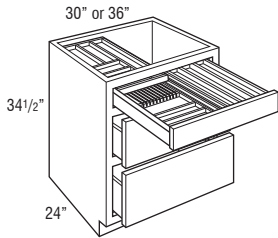
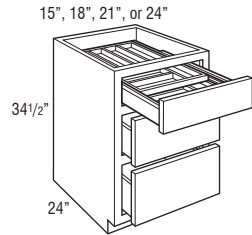

3DB15WTC	1829	1835	1847	1857	1868	1878	1945	1997	2046	2087	2123	2250
3DB18WTC	1921	1927	1939	1950	1961	1971	2047	2099	2151	2198	2240	2372
3DB21WTC	2014	2021	2035	2048	2062	2074	2151	2210	2267	2315	2356	2499
3DB24WTC	2081	2089	2102	2116	2129	2143	2225	2287	2345	2401	2444	2594
3DB30WTC	2532	2541	2573	2606	2638	2671	2785	2864	2948	3027	3104	3288
3DB36WTC	2721	2731	2784	2835	2887	2939	3063	3151	3242	3332	3407	3613

- Exterior height for bottom two drawer boxes is 6 3/8".
- Exterior WTC drawer box height is 3 3/4", interior height of top and bottom tier is 1 3/8".
- Wood Tiered Cutlery Divider Drawer is also available as an accessory. See page 312.

Custom Modifications

AUTH	CBO	CCO	CFNTO	CFP	CFRMO	CH	CMAT	CND	CW	DRT	DRWPWR	DRWSEC	DRWTK	DRWWRM	EXBK	EX	FB	FD	FFD	FPEB	FTK	FTK_V	ID	INVFRM	MIP	P	PTOWB	RD	RECTK	RT	SCPDRW	TD	TOTSSS	TVR_V	VTK	
•	•	•	•	•	•	•	•	•	•	•	•	•	• ¹	•	•	•	•	•	•	•	•	•	•	•	•	•	•	•	•	•	•	•	•	•	•	•

Construction Upgrades

APC	ET	PE
•	•	•

Door Options

DPSRR

¹ Not available on 15" wide

THREE DRAWER BASE with DEEP DRAWER

24", 27", 30", 33", or 36"

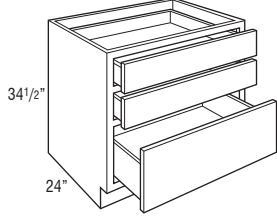

Price Point	1	2	3	4	5	6	7	8	9	10	11	12
3DBDD24	1908	1919	1932	1944	1957	1969	2052	2115	2175	2225	2271	2419
3DBDD27	2004	2014	2036	2057	2079	2100	2200	2271	2343	2407	2467	2633
3DBDD30	2096	2106	2137	2168	2200	2231	2345	2427	2511	2588	2663	2846
3DBDD33	2258	2269	2303	2336	2370	2404	2528	2616	2703	2785	2869	3068
3DBDD36	2432	2444	2481	2517	2554	2589	2723	2816	2913	3003	3092	3306

• Exterior height of bottom drawer box is 10".

Custom Modifications

AUTH	CBO	CCO	CFNTO	CFP	CFRMO	CH	CMAT	CND	CW	DRT	DRWPWR	DRWSEC	DRWTK	DRWWRM	EXBK	EX	FB	FD	FFD	FPEB	FTK	FTK_V	ID	INVFRM	MIP	P	PTOWB	RD	RECTK	RT	SCDRW	TD	TOTSSS	TVR_V	VTK
•	•	•	•	•	•	•	•	•	• ¹	•	•	•	•	•	•	•	•	•	•	•	•	•	•	•	•	•	•	•	•	•	•	•	•	•	•

Construction Upgrades

APC	ET	PE
•	•	•

Door Options

DPSRR
•

¹ Not available on 24" wide

THREE DRAWER BASE BUFFET with DEEP DRAWER

30", 33", or 36"

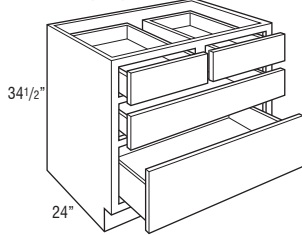

3DBBDD30	2399	2411	2447	2483	2519	2554	2685	2780	2873	2962	3050	3260
3DBBDD33	2583	2596	2635	2675	2714	2752	2894	2995	3098	3193	3288	3515
3DBBDD36	2782	2796	2838	2881	2923	2965	3119	3228	3338	3442	3545	3789

• Exterior height of bottom drawer box is 10".

Custom Modifications

AUTH	CBO	CCO	CFNTO	CFP	CFRMO	CH	CMAT	CND	CW	DRT	DRWPWR	DRWSEC	DRWTK	DRWWRM	EXBK	EX	FB	FD	FFD	FPEB	FTK	FTK_V	ID	INVFRM	MIP	P	PTOWB	RD	RECTK	RT	SCDRW	TD	TOTSSS	TVR_V	VTK
•	•	•	•	•	•	•	•	•	• ¹	•	• ²	• ²	•	•	•	•	•	•	•	•	•	•	•	•	•	•	•	•	•	•	•	•	•	•	•

Construction Upgrades

APC	ET	PE
•	•	•

Door Options

DPSRR
•

¹ Not available on 30" wide

² Not available on 30" and 33" wide

FOUR DRAWER BASE

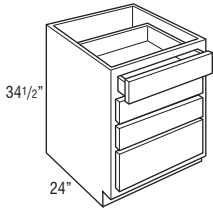

24", 27", 30", 33", or 36"

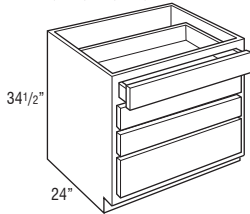

Price Point	1	2	3	4	5	6	7	8	9	10	11	12
4DB12	1529	1537	1548	1559	1570	1581	1656	1709	1764	1810	1848	1988
4DB15	1597	1605	1618	1631	1643	1655	1733	1790	1848	1896	1936	2082
4DB18	1671	1679	1692	1706	1719	1732	1817	1874	1940	1989	2034	2188
4DB21	1751	1760	1774	1789	1803	1817	1904	1968	2032	2089	2135	2296
4DB24	1848	1857	1873	1887	1903	1917	2010	2078	2144	2206	2257	2432
4DB27	1997	2007	2023	2038	2054	2069	2171	2243	2317	2383	2438	2626
4DB30	2156	2167	2185	2202	2220	2237	2346	2424	2502	2573	2633	2836
4DB33	2326	2337	2356	2376	2395	2414	2536	2619	2701	2780	2844	3064
4DB36	2512	2524	2546	2566	2587	2607	2735	2828	2918	3002	3070	3308

• Exterior height of bottom drawer box is 6 3/8".

Custom Modifications

AUTH	CBO	CCO	CFNTO	CFP	CFRMO	CH	CMAT	CND	CW	DRT	DRWPWR	DRWSEC	DRWTK	DRWWRM	EXBK	EX	FB	FD	FFD	FPEB	FTK	FTK_V	ID	INFRM	MIP	P	PTOWB	RD	RECTK	RT	SCPDRW	TD	TOTSSS	TVR	V	VTK
•	•	•	•	•	•	•	•	•	•	• ¹	• ²	• ³	• ²	•	•	•	•	•	•	•	•	• ¹	•	•	•	•	•	•	•	•	•	•	•	•	•	•

Construction Upgrades

APC	ET	PE
•	•	•

Door Options

DPSRR
•

¹ Not available on 12" wide

² Not available on 12" and 15" wide

³ Available only on 18", 21", and 24" wide

FOUR DRAWER BASE with WOOD TIERED CUTLERY DIVIDER DRAWER

15", 18", 21", or 24"

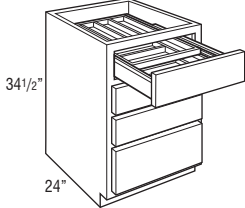

30" or 36"

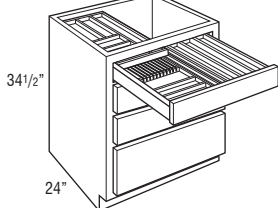

4DB15WTCD	2075	2083	2096	2109	2121	2133	2211	2268	2326	2374	2414	2560
4DB18WTCD	2167	2175	2188	2202	2215	2228	2313	2370	2436	2485	2530	2684
4DB21WTCD	2266	2275	2289	2304	2318	2332	2419	2483	2547	2604	2650	2811
4DB24WTCD	2380	2389	2405	2419	2435	2449	2542	2610	2676	2738	2789	2964
4DB30WTCD	2851	2862	2880	2897	2915	2932	3041	3119	3197	3268	3328	3531
4DB36WTCD	3243	3255	3277	3297	3318	3338	3466	3559	3649	3733	3801	4039

- Exterior WTCD drawer box height is 3 3/4", interior height of top and bottom tier is 1 3/8".
- Wood Tiered Cutlery Divider Drawer is also available as an accessory. See page 312.
- Exterior height of bottom drawer box is 6 3/8".

Custom Modifications

AUTH	CBO	CCO	CFNTO	CFP	CFRMO	CH	CMAT	CND	CW	DRT	DRWPWR	DRWSEC	DRWTK	DRWWRM	EXBK	EX	FB	FD	FFD	FPEB	FTK	FTK_V	ID	INFRM	MIP	P	PTOWB	RD	RECTK	RT	SCPDRW	TD	TOTSSS	TVR	V	VTK
•	•	•	•	•	•	•	•	•	•	•	•	•	• ¹	•	•	•	•	•	•	•	•	•	•	•	•	•	•	•	•	•	•	•	•	•	•	•

Construction Upgrades

APC	ET	PE
•	•	•

Door Options

DPSRR
•

¹ Not available on 15" wide

BASE WASTEBASKET

	Price Point	1	2	3	4	5	6	7	8	9	10	11	12
BWB15		1521	1564	1574	1583	1592	1601	1652	1684	1720	1756	1780	1867
BWB152		1590	1633	1643	1652	1661	1670	1721	1753	1789	1825	1849	1936
BWB18		1594	1641	1658	1673	1689	1705	1757	1794	1830	1865	1895	1986
BWB21		1676	1724	1745	1765	1785	1805	1862	1899	1941	1980	2009	2110

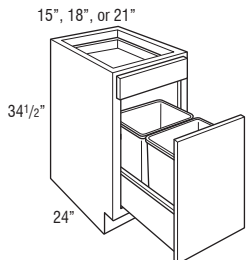
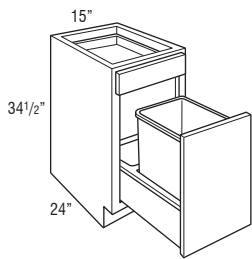

- BWB15 includes one 35 quart gray wastebasket and one trash bag storage area.
- BWB152 includes two 27 quart gray wastebaskets.
- BWB18 and BWB21 include two 35 quart gray wastebaskets.
- BWB15 and BWB18 can be reduced in depth to 21". When reduced, BWB15 includes one wastebasket. When reduced, BWB18 includes one wastebasket and one trash bag storage area.
- Wastebasket lid available for purchase separately, see page 311. BWBLID fits 35 quart wastebaskets.
- BWBLID can only be used on the front wastebasket of BWB18 and BWB21.
- Pull-out features undermount soft-close guides.

Custom Modifications

AUTH	CBO	CCO	CFNTO	CFP	CFRMO	CH	CMAT	CND	CW	DRT	DRWPWR	DRWSEC	DRWTK	DRWRM	EXBK	EX	FB	FD	FFD	FPEB	FTK	FTK_V	ID	INVFRM	MIP	P	PTOWB	RD	RECTK	RT	SCPDRW	TD	TOTSSS	TVR_V	VTK	
•	•	•	•	•	•	•	•	•	•	•	• ¹	• ¹	• ¹	•	•	•	•	•	•	•	•	•	•	•	•	•	•	• ²	•	•	•	•	•	•	•	•

Construction Upgrades

APC	ET	PE
•	•	•

Door Options

DPSRR
•

¹ Not available on 15" wide

² Not available on 15" (double wastebasket version) and 21" wide

BASE PAPER TOWEL CABINET with WASTEBASKET

BPT15WB	1552	1595	1605	1614	1623	1632	1683	1715	1751	1787	1811	1898
BPT18WB	1625	1672	1689	1704	1720	1736	1788	1825	1861	1896	1926	2017

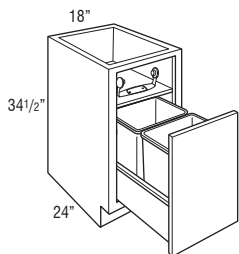
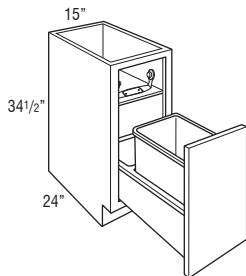

- Upper section of cabinet features an open cubby area with veneer finished interior sides and fixed shelf, a clear acrylic paper towel holder, and a storage area behind the paper towel roll for an additional three to four paper towel rolls. Maximum paper towel diameter is 6".
- Cabinet back and lower section of cabinet has standard interior.
- BPT15WB includes one 35 quart gray wastebasket and one trash bag storage area.
- BPT18WB includes two 35 quart gray wastebaskets.
- Can be reduced in depth to 21". When reduced, BPT15WB includes one wastebasket. When reduced, BPT18WB includes one wastebasket and one trash bag storage area.
- BWBLID will not fit due to interference with the cubby area.
- Pull-out features undermount soft-close guides.

Custom Modifications

AUTH	CBO	CCO	CFNTO	CFP	CFRMO	CH	CMAT	CND	CW	DRT	DRWPWR	DRWSEC	DRWTK	DRWRM	EXBK	EX	FB	FD	FFD	FPEB	FTK	FTK_V	ID	INVFRM	MIP	P	PTOWB	RD	RECTK	RT	SCPDRW	TD	TOTSSS	TVR_V	VTK	
•	•	•	•	•	•	•	•	•	•	•	•	• ¹	•	•	•	•	•	•	•	•	•	•	•	•	•	•	•	•	•	•	•	•	•	•	•	•

Construction Upgrades

APC	ET	PE
•	•	•

Door Options

DPSRR
•

¹ Not available on 15" wide

BASE WASTEBASKET FULL HEIGHT

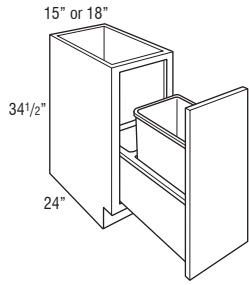

BWB15FH
BWB18FH

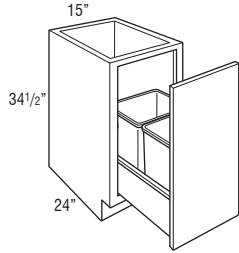

BWB15FH2

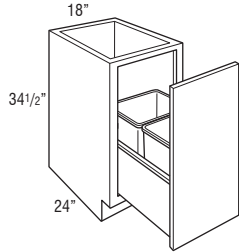

BWB18FH2

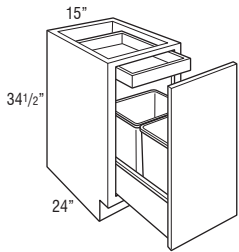

BWB15FHRT2

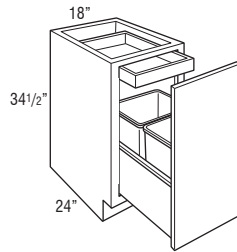

BWB18FHRT2

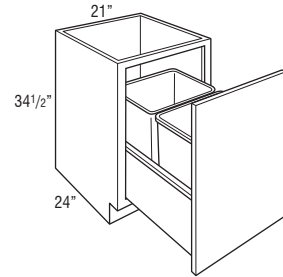

BWB21FH

Price Point

	1	2	3	4	5	6	7	8	9	10	11	12
BWB15FH	1258	1298	1329	1360	1392	1423	1468	1499	1531	1561	1583	1661
BWB18FH	1336	1371	1409	1446	1484	1521	1570	1601	1633	1668	1691	1770
BWB15FH2	1327	1367	1398	1429	1461	1492	1537	1568	1600	1630	1652	1730
BWB18FH2	1344	1379	1415	1450	1486	1521	1570	1608	1641	1668	1692	1770
BWB15FHRT2	1611	1651	1682	1713	1745	1776	1821	1852	1884	1914	1936	2014
BWB18FHRT2	1620	1655	1693	1730	1768	1805	1854	1885	1917	1952	1975	2054
BWB21FH	1410	1450	1490	1529	1570	1609	1657	1695	1734	1768	1795	1878

- BWB15FH and BWB18FH include one 50 quart gray wastebasket and one trash bag storage area.
- BWB15FH2 includes two 27 quart gray wastebaskets.
- BWB18FH2 includes two 35 quart gray wastebaskets.
- BWB15FHRT2 includes two 27 quart gray wastebaskets and one roll tray.
- BWB18FHRT2 includes two 35 quart gray wastebaskets and one roll tray.
- BWB21FH has two 50 quart gray wastebaskets.
- Wastebasket lid available for purchase separately, see page 311. BWBLID fits 35 quart wastebaskets. BWBFHLID fits 50 quart wastebaskets.
- BWBLID can only be used on the front wastebasket of BWB18FH2 and BWB18FHRT2.
- BWBFHLID can only be used on the front wastebasket of BWB21FH.
- Pull-out features undermount soft-close guides.

Custom Modifications

AUTH	CBO	CCO	CFNTO	CFP	CFRMO	CH	CMAT	CND	CW	DRT	DRWPWR	DRWSEC	DRWTK	DRWRM	EXBK	EX	FB	FD	FFD	FPEB	FTK	FTK_V	ID	INVFRM	MIP	P	PTOWB	RD	RECTK	RT	SCPDW	TD	TOTSSS	TVR	VTK
•	•	•	•	•	•	•	•	•	•	•	•	•	•	•	•	•	•	•	•	•	•	•	•	•	•	•	•	•	•	•	•	•	•	•	•

Construction Upgrades

APC	ET	PE
•	•	•

Door Options

DPSRR
•

¹ Not available on 15" wide

Price
Point

1

2

3

4

5

6

7

8

9

10

11

12

**BASE PAPER TOWEL CABINET with
WASTEBASKET, FULL HEIGHT**

BPT15WBFH	1625	1672	1689	1704	1720	1736	1788	1825	1861	1896	1926	2017
BPT18WBFH	1707	1755	1776	1796	1816	1836	1893	1930	1972	2011	2040	2141

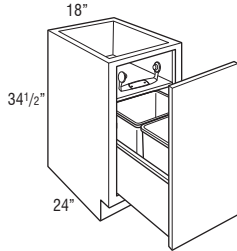
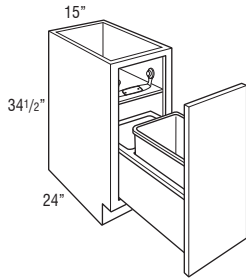

- Upper section of cabinet features an open cubby area with a fixed shelf, a clear acrylic paper towel holder, and a storage area behind the paper towel roll for an additional three to four paper towel rolls. Maximum paper towel diameter is 6".
- Cabinet back and lower section of cabinet has standard interior.
- BPT15WBFH includes one 35 quart gray wastebasket and one trash bag storage area.
- BPT18WBFH includes two 35 quart gray wastebaskets.
- Can be reduced in depth to 21". When reduced, BPT15WBFH includes one wastebasket. When reduced, BPT18WBFH includes one wastebasket and one trash bag storage area.
- BWBLID will not fit due to interference with the cubby area.
- Pull-out features undermount soft-close guides.

Custom Modifications

AUTH	CBO	CCO	CFNTO	CFP	CFRMO	CH	CMAT	CND	CW	DRT	DRWPWR	DRWSEC	DRWTK	DRWWRM	EXBK	EX	FB	FD	FFD	FPEB	FTK	FTK_V	ID	INVFRM	MIP	P	PTOWB	RD	RECTK	RT	SCPDRW	TD	TOTSSS	TVR_V	VTK
•	•	•											• ¹		•						•	•	•			•	•	•	•						•

Construction Upgrades

APC	ET	PE
•		•

Door Options

DPSRR
•

¹ Not available on 15" wide**BASE WINE CUBBY, 24" DEEP**

BWC634.5	1100	1100	1100	1100	1100	1100	1100	1100	1100	1100	1100	1100
-----------------	------	------	------	------	------	------	------	------	------	------	------	------

- Vertical application only.

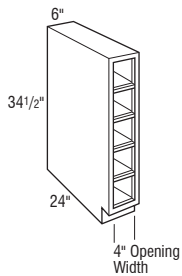
**Custom Modifications**

AUTH	CBO	CCO	CFNTO	CFP	CFRMO	CH	CMAT	CND	CW	DRT	DRWPWR	DRWSEC	DRWTK	DRWWRM	EXBK	EX	FB	FD	FFD	FPEB	FTK	FTK_V	ID	INVFRM	MIP	P	PTOWB	RD	RECTK	RT	SCPDRW	TD	TOTSSS	TVR_V	VTK
					•										•											STD		•							•

Construction Upgrades

APC	ET	PE

Door Options

DPSRR

161

BASE CABINETS

BASE APOTHECARY DRAWER, 24" DEEP

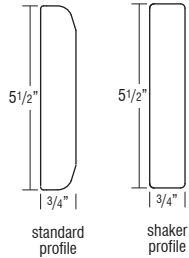
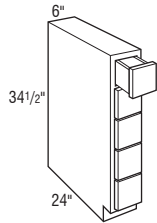

BAD634.5

2176	2176	2176	2176	2176	2176	2176	2176	2176	2176	2176	2176	2176
------	------	------	------	------	------	------	------	------	------	------	------	------

- Vertical application only.
- Includes five 1/2" hardwood drawers with rabbet joint, 21" deep.
- Drawer opening is 4" wide x 4 13/16" high.
- If ordered with Heirloom Technique, will not feature sand-through characteristics.
- Drawer front is unique to item and will not match profile chosen.
- All styles use standard drawer front profile except shaker door styles, which use the shaker profile.
- Does not include soft-close guides. Drawer slides on wooden frame.

162

BASE CABINETS

Custom Modifications

AUTH	CBO	CCO	CFNTO	CFP	CFRMO	CH	CMAT	CND	CW	DRT	DRWPWR	DRWSEC	DRWTK	DRWWRM	EXBK	EX	FB	FD	FFD	FPEB	FTK	FTK_V	ID	INVFRM	MIP	P	PTOWB	RD	RECTK	RT	SCPDWR	TD	TOTSSS	TVR	V	VTK		

Construction Upgrades

APC	ET	PE

Door Options

DPSRR

BASE PANTRY PULL-OUT

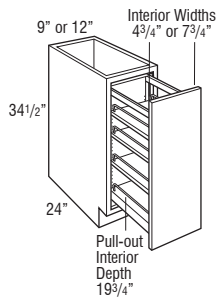

BPP9

1256	1268	1298	1327	1356	1385	1458	1509	1558	1602	1639	1755
------	------	------	------	------	------	------	------	------	------	------	------

BPP12

1334	1354	1387	1419	1452	1484	1558	1612	1667	1719	1755	1884
------	------	------	------	------	------	------	------	------	------	------	------

- All styles feature a natural finish soft-close wood pull-out with adjustable shelves and chrome rail sides. The adjustable rear wall of the pull-out prevents items from falling behind the unit.

Custom Modifications

AUTH	CBO	CCO	CFNTO	CFP	CFRMO	CH	CMAT	CND	CW	DRT	DRWPWR	DRWSEC	DRWTK	DRWWRM	EXBK	EX	FB	FD	FFD	FPEB	FTK	FTK_V	ID	INVFRM	MIP	P	PTOWB	RD	RECTK	RT	SCPDWR	TD	TOTSSS	TVR	V	VTK		

Construction Upgrades

APC	ET	PE

Door Options

DPSRR

¹ RECTKALL not available on 9" wide

BASE TRAY DIVIDER PANTRY PULL-OUT

Price Point	1	2	3	4	5	6	7	8	9	10	11	12
BTDP12	2150	2170	2203	2235	2268	2300	2374	2428	2483	2535	2571	2700

- All styles feature a natural finish soft-close wood pull-out with two removable center dividers and two snap on T-bars.
- Tray dividers are chrome plated steel.

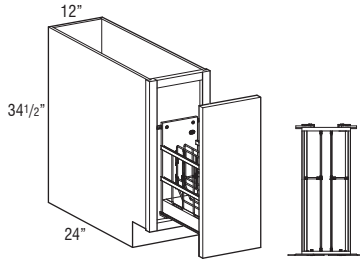

Custom Modifications

AUTH	CBO	CCO	CFNTO	CFP	CFRMO	CH	CMAT	CND	CW	DRT	DRWPWR	DRWSEC	DRWTK	DRWWRM	EXBK	EX	FB	FD	FFD	FPEB	FTK	FTK_V	ID	INVFRM	MIP	P	PTOWB	RD	RECTK	RT	SCPDRW	TD	TOTSSS	TVR_V	VTK
•	•	•			•										•	•	•				•	•				•									•

Construction Upgrades

APC	ET	PE
•		•

Door Options

DPSRR
•

¹ RECTKALL and RECTKL/RECTKR not available

BASE CONTAINER ORGANIZER PANTRY PULL-OUT

BCOPP12	3052	3072	3105	3137	3170	3202	3276	3330	3385	3437	3473	3602
----------------	------	------	------	------	------	------	------	------	------	------	------	------

- Full extension, soft-close wood pull-out with natural finish and two fixed shelves.
- Includes seven OXO™ Good Grips POP containers (BPA Free): three 1.7 quart, three 4.3 quart, and one 2.6 quart.

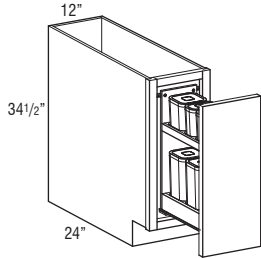

Custom Modifications

AUTH	CBO	CCO	CFNTO	CFP	CFRMO	CH	CMAT	CND	CW	DRT	DRWPWR	DRWSEC	DRWTK	DRWWRM	EXBK	EX	FB	FD	FFD	FPEB	FTK	FTK_V	ID	INVFRM	MIP	P	PTOWB	RD	RECTK	RT	SCPDRW	TD	TOTSSS	TVR_V	VTK
•	•	•			•										•	•	•				•	•				•									•

Construction Upgrades

APC	ET	PE
•		•

Door Options

DPSRR
•

BASE UTENSIL PANTRY PULL-OUT

BUPP9	1651	1663	1693	1722	1751	1780	1853	1904	1953	1997	2034	2150
BUPP12	1729	1749	1782	1814	1847	1879	1953	2007	2062	2114	2150	2279

- All styles feature a natural finish soft-close wood pull-out with two adjustable shelves (including canister shelf) and one fixed shelf with chrome rail sides. Top adjustable shelf features three stainless steel canisters for utensils. The adjustable rear wall of the pull-out prevents items from falling behind the unit.
- BUPP9 canisters are 5.85" tall and have an inside diameter of 4.3".
- BUPP12 canisters are 6.7" tall and have an inside diameter of 5".

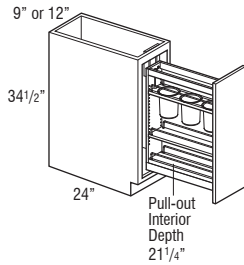

Custom Modifications

AUTH	CBO	CCO	CFNTO	CFP	CFRMO	CH	CMAT	CND	CW	DRT	DRWPWR	DRWSEC	DRWTK	DRWWRM	EXBK	EX	FB	FD	FFD	FPEB	FTK	FTK_V	ID	INVFRM	MIP	P	PTOWB	RD	RECTK	RT	SCPDRW	TD	TOTSSS	TVR_V	VTK
•	•	•			•										•	•	•				•	•				•									•

Construction Upgrades

APC	ET	PE
•		•

Door Options

DPSRR
•

¹ RECTKALL not available on 9" wide

BASE UTENSIL PANTRY PULL-OUT with KNIFE BLOCK

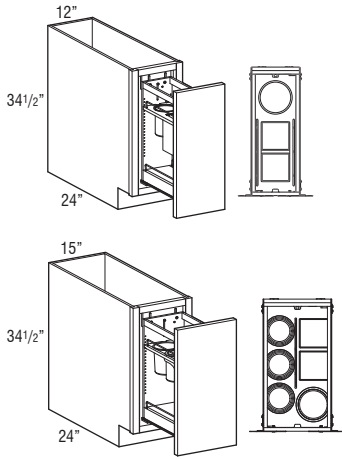

	Price Point	1	2	3	4	5	6	7	8	9	10	11	12
BUPPKB12		2801	2821	2854	2886	2919	2951	3025	3079	3134	3186	3222	3351
BUPPKB15		3193	3213	3246	3278	3311	3343	3417	3471	3526	3578	3614	3743

- Full extension, soft-close wood pull-out with natural finish and one fixed shelf.
- BUPPKB12 features an adjustable shelf with two knife blocks, one stainless steel canister, four cutting boards, and one fixed shelf with chrome rails. Canister is 6.7" tall and has an inside diameter of 5".
- BUPPKB15 features an adjustable shelf with two knife blocks, four stainless steel canisters, four cutting boards, and one fixed shelf with chrome rails. Three canisters are 5.85" tall and have an inside diameter of 4.3", and one is 6.7" tall with an inside diameter of 5".
- Knife block features movable flex rods that adjust to hold a multitude of knives.
- Includes adjustable rear wall for extra strength and stability.
- Adjustable shelf is easily reversible for placement of knife blocks in the front or rear.

Custom Modifications

AUTH	CBO	CCO	CFNT0	CFP	CFRMO	CH	CMAT	CND	CW	DRT	DRWPWR	DRWSEC	DRWTK	DRWWRM	EXBK	EX	FB	FD	FFD	FPEB	FTK	V	ID	INVERM	MIP	P	PTOWB	RD	RECTK	RT	SCPDRW	TD	TOTSSS	TVR	V	VTK
•	•	•			•										•	•	•			•	•	• ¹							•							•

Construction Upgrades

APC	ET	PE
•		•

Door Options

DPSRR
•

¹ Not available on 12" wide

BASE BOX COLUMN PULL-OUT

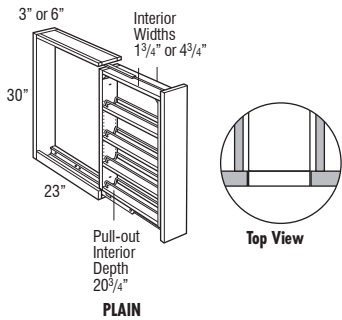

PLAIN

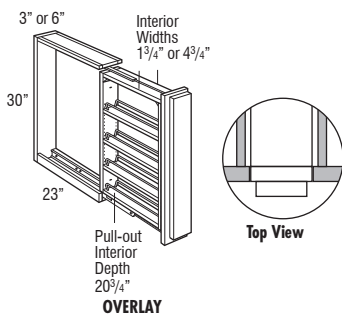

OVERLAY

BBCPO3 (Plain)	1216	1216	1216	1216	1216	1216	1216	1216	1216	1216	1216	1216	1216
BBCPO6 (Plain)	1428	1428	1428	1428	1428	1428	1428	1428	1428	1428	1428	1428	1428
BBCPO3OL (Overlay)	1268	1268	1268	1268	1268	1268	1268	1268	1268	1268	1268	1268	1268
BBCPO6OL (Overlay)	1486	1486	1486	1486	1486	1486	1486	1486	1486	1486	1486	1486	1486

- Top, back, and bottom are veneer plywood.
- Recommend installation between two cabinets. If installed on the end of a run or adjacent to an appliance, must use a 3/4" thick end panel.
- Filler is included but unattached.
- Install unit before removing shipping brace and attaching filler.
- Overlay application includes profiled full overlay filler.
- Decorative hardware required on base units.
- Toe-kick not included; must be built up in the field.
- All styles feature a natural finish soft-close wood pull-out with adjustable shelves and chrome rail sides.
- BBCPO3 and BBCPO6 will not feature sand-through characteristics if ordered with Heirlooming Technique.
- In order to allow proper clearance for opening and closing, allow an additional 1/8" space between adjacent cabinet face frames. The 3" wide pull-outs require 3 1/8" space and the 6" wide pull-outs require 6 1/8" space. Spacers are included with the pull-outs to allow for proper installation.
- For full access from both sides of unit, do not install against a wall or next to deeper appliances and cabinets.

MODIFICATIONS

No modifications available for these products.

Finish Techniques

Heirlooming
• ¹

¹ Not available on Plain

FULL HEIGHT RANGETOP BASE

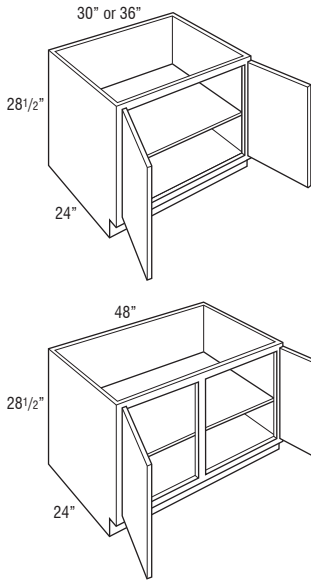

Price Point	1	2	3	4	5	6	7	8	9	10	11	12
RTBFH3028.5	772	819	862	904	947	989	1051	1095	1136	1176	1207	1309
RTBFH3628.5	818	866	915	965	1014	1063	1127	1171	1217	1261	1296	1406

RTBFH4828.5CS	1082	1151	1225	1299	1373	1446	1532	1595	1658	1716	1766	1912
----------------------	------	------	------	------	------	------	------	------	------	------	------	------

- One full depth shelf.
- Aligns with standard base cabinet door. Door height is 23" for full overlay and 21 1/2" for partial overlay.
- Top cross rail is 2" high, can be trimmed up to 1".
- Installed Roll Trays may interfere with gas line, see chart on page 11 for clearance depth behind roll tray.
- For use with rangetops with front controls.
- RTBFH4828.5CS: For 23" or deeper cabinets, the shelf will only be 21" deep.

Custom Modifications

AUTH	CBO	CCO	CFNTO	CFP	CFRMO	CH	CMAT	CND	CW	DRT	DRWPWR	DRWSEC	DRWTK	DRWWRM	EXBK	EX	FB	FD	FFD	FPEB	FTK	FTK_V	ID	INVFRM	MIP	P	PTOWB	RD	RECTK	RT	SCPDW	TD	TOTSSS	TVR_V	VTK
•	•	•	•	•	•	• ¹	•	•	• ²	•	•	•	•	•	•	•	•	•	•	•	•	•	•	•	•	•	•	•	•	•	•	•	•	•	•

Construction Upgrades

APC	ET	PE
•	•	•

Door Options

DPSRR
•

¹ Minimum height is 25 3/4"
² Not available on 30" wide

BASE OVEN CABINET

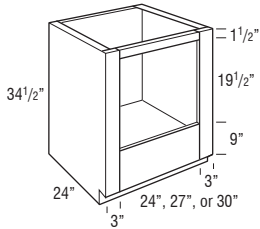

B030	1044	1044	1044	1044	1044	1044	1044	1044	1044	1044	1044	1044
B033	1101	1101	1101	1101	1101	1101	1101	1101	1101	1101	1101	1101
B036	1177	1177	1177	1177	1177	1177	1177	1177	1177	1177	1177	1177

- Oven cabinet has laminated interior.
- May not hold cooktop and slide-in oven combination. Refer to cooktop and slide-in oven manufacturer specifications.
- If ordered with Heirlooming Technique, will not feature sand-through characteristics.
- For built-in appliance support, OCINSTALLKIT is included in 24" deep oven cabinets (see page 313 for details), but will not be included when depth is modified.
- OCINSTALLKIT weight limit is 400 lbs. per pair.
- Heat shields are sold separately as an accessory. See page 313.

Model	Opening Width	Maximum Width	Opening Height	Maximum Height*
B030	24"	28 1/2"	19 1/2"	27 1/2"
B033	27"	31 1/2"	19 1/2"	27 1/2"
B036	30"	34 1/2"	19 1/2"	27 1/2"

*Top frame cross rail can be removed during field installation if cabinet is properly installed between two adjacent cabinets, increasing the maximum height to 28 1/4".

Custom Modifications

AUTH	CBO	CCO	CFNTO	CFP	CFRMO	CH	CMAT	CND	CW	DRT	DRWPWR	DRWSEC	DRWTK	DRWWRM	EXBK	EX	FB	FD	FFD	FPEB	FTK	FTK_V	ID	INVFRM	MIP	P	PTOWB	RD	RECTK	RT	SCPDW	TD	TOTSSS	TVR_V	VTK
•	•	•	•	•	•	•	•	•	•	•	•	•	•	•	•	•	•	•	•	•	•	•	•	•	•	•	•	•	•	•	•	•	•	•	•

Construction Upgrades

APC	ET	PE
•	•	•

Door Options

DPSRR
•

¹ Not available on 30" wide

BASE BUILT-IN MICROWAVE CABINET with DRAWER

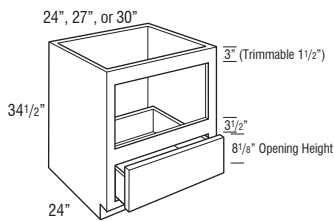

Price Point	1	2	3	4	5	6	7	8	9	10	11	12
BBMWD24	1383	1390	1398	1406	1413	1421	1450	1505	1564	1614	1658	1793
BBMWD27	1631	1639	1644	1650	1655	1660	1728	1794	1860	1925	1976	2138
BBMWD30	1641	1649	1655	1661	1667	1672	1738	1804	1872	1936	1987	2149

- Standard interior.
- For built-in appliance support, OCINSTALLKIT is included in 24" deep cabinets (see page 313 for details), but will not be included when depth is modified.
- OCINSTALLKIT weight limit is 400 lbs. per pair.
- The usable cabinet face height between top of drawer front and top of cabinet is 19 1/8" for partial overlay and 19 3/4" for full overlay. Be sure to verify overall appliance height, gap requirements, and cut-out dimensions with cabinet specifications.

Model	Opening Width	Maximum Width	Opening Height	Maximum Height
BBMWD24	21"	22 1/2"	13 7/8"	16 7/8"
BBMWD27	24"	25 1/2"	13 7/8"	16 7/8"
BBMWD30	27"	28 1/2"	13 7/8"	16 7/8"

Custom Modifications

AUTH	CBO	CCO	CFNTO	CFP	CFRMO	CH	CMAT	CND	CW	DRT	DRWPWR	DRWSEC	DRWTK	DRWWRM	EXBK	EX	FB	FD	FFD	FPEB	FTK	FTK_V	ID	INVFRM	MIP	P	PTOWB	RD	RECTK	RT	SCPDRW	TD	TOTSSS	TVR	V	VTK		
•	•	•	•	•	•	•	•	•	•	• ¹	•	•	•	•	•	•	•	•	•	•	•	•	•	•	•	•	•	•	•	•	•	•	•	•	•	•	•	•

Construction Upgrades

APC	ET	PE
•	•	•

Door Options

DPSRR

¹ Not available on 24" wide

BASE MICROWAVE CABINET with DRAWER

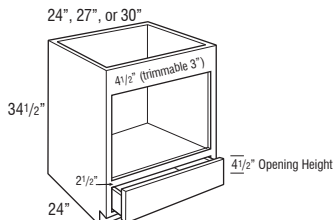

BMWD24	1456	1464	1476	1488	1501	1512	1528	1586	1646	1699	1745	1887
BMWD27	1588	1596	1607	1618	1630	1640	1673	1735	1799	1860	1907	2063
BMWD30	1728	1737	1743	1748	1754	1758	1831	1900	1970	2038	2091	2261

- Reinforced plywood floor.
- The usable cabinet face height between top of drawer front and top of cabinet is 23 1/2" for partial overlay and full overlay. Be sure to verify overall appliance height, gap requirements, and cut-out dimensions with cabinet specifications.

Model	Opening Width	Maximum Width	Opening Height	Maximum Height
BMWD24	21"	22 1/2"	17"	20"
BMWD27	24"	25 1/2"	17"	20"
BMWD30	27"	28 1/2"	17"	20"

Custom Modifications

AUTH	CBO	CCO	CFNTO	CFP	CFRMO	CH	CMAT	CND	CW	DRT	DRWPWR	DRWSEC	DRWTK	DRWWRM	EXBK	EX	FB	FD	FFD	FPEB	FTK	FTK_V	ID	INVFRM	MIP	P	PTOWB	RD	RECTK	RT	SCPDRW	TD	TOTSSS	TVR	V	VTK		
•	•	•	•	•	•	•	•	•	•	• ¹	•	•	•	•	•	•	•	•	•	•	•	•	•	•	•	•	•	•	•	•	•	•	•	•	•	•	•	•

Construction Upgrades

APC	ET	PE
•	•	•

Door Options

DPSRR

¹ Not available on 24" wide

BASE MICROWAVE CABINET with DEEP DRAWER

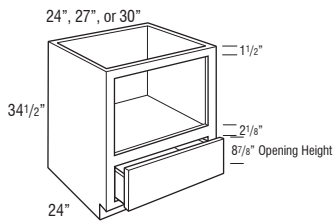

BMWD24DD	1456	1464	1476	1488	1501	1512	1528	1586	1646	1699	1745	1887
BMWD27DD	1588	1596	1607	1618	1630	1640	1673	1735	1799	1860	1907	2063
BMWD30DD	1793	1802	1808	1813	1819	1823	1895	1964	2035	2102	2155	2325

- Reinforced plywood floor.
- The usable cabinet face height between top of drawer front and top of cabinet is 19 1/8" for partial overlay and 18 3/8" for full overlay. Be sure to verify overall appliance height, gap requirements, and cut-out dimensions with cabinet specifications.

Model	Opening Width	Maximum Width	Opening Height	Maximum Height
BMWD24DD	21"	22 1/2"	16"	16"
BMWD27DD	24"	25 1/2"	16"	16"
BMWD30DD	27"	28 1/2"	16"	16"

Custom Modifications

AUTH	CBO	CCO	CFNTO	CFP	CFRMO	CH	CMAT	CND	CW	DRT	DRWPWR	DRWSEC	DRWTK	DRWWRM	EXBK	EX	FB	FD	FFD	FPEB	FTK	FTK_V	ID	INVFRM	MIP	P	PTOWB	RD	RECTK	RT	SCPDRW	TD	TOTSSS	TVR	V	VTK		
•	•	•	•	•	•	•	•	•	•	• ¹	•	•	•	•	•	•	•	•	•	•	•	•	•	•	•	•	•	•	•	•	•	•	•	•	•	•	•	•

Construction Upgrades

APC	ET	PE
•	•	•

Door Options

DPSRR

¹ Not available on 24" wide

Price Point

BASE CORNER PENINSULA

	1	2	3	4	5	6	7	8	9	10	11	12
BCP24 L or R	1701	1796	1818	1839	1860	1882	1990	2068	2144	2220	2276	2463
BCP24	1791	1891	1914	1936	1959	1981	2096	2175	2259	2337	2396	2594

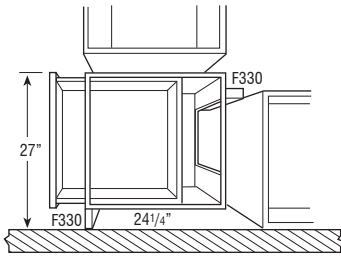

- Cabinet width is 24".
- Adjustable full depth shelf.
- Includes two 3" fillers, shipped unattached. Fillers are required for drawer and door opening clearance of adjacent cabinets.
- Unfinished toekick on front (B24) and back (BCP) of cabinet.
- Will not accept roll trays.
- Peninsula base cabinets are 1/4" deeper to allow back paneling application on adjacent cabinets in a run with standard 24" deep cabinets.

Custom Modifications

AUTH	CBO	CCO	CFNTO	CFP	CFRMO	CH	CMAT	CND	CW	DRT	DRWPWR	DRWSEC	DRWTK	DRWWRM	EXBK	EX	FB	FD	FFD	FPEB	FTK	FTK V	ID	INVFRM	MIP	P	PTOWB	RD	RECTK	RT	SCPDRW	TD	TOTSSS	TVR	V	VTK	
•	•	•	•	•	•	•						•					•	•			•	•				•	STD		•	STD/•							•

Construction Upgrades

APC	ET	PE
•		•

Door Options

DPSRR
•

¹ RECTKALL not available, RECTKBK is standard, and RECTKL/RECTKR are available

BASE CORNER PENINSULA with FULL HEIGHT DOOR

	1418	1506	1544	1583	1621	1658	1757	1826	1902	1970	2025	2191
--	------	------	------	------	------	------	------	------	------	------	------	------

BCP24FH	1492	1587	1627	1667	1706	1745	1849	1922	2003	2075	2131	2305
----------------	------	------	------	------	------	------	------	------	------	------	------	------

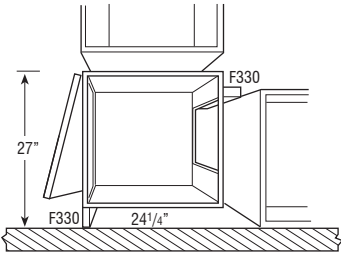

- Cabinet width is 24".
- Adjustable full depth shelf.
- Includes two 3" fillers, shipped unattached. Fillers are required for drawer and door opening clearance of adjacent cabinets.
- Unfinished toekick on front (B24) and back (BCP) of cabinet.
- Will not accept roll trays.
- Peninsula base cabinets are 1/4" deeper to allow back paneling application on adjacent cabinets in a run with standard 24" deep cabinets.

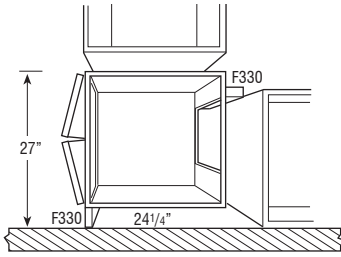

Custom Modifications

AUTH	CBO	CCO	CFNTO	CFP	CFRMO	CH	CMAT	CND	CW	DRT	DRWPWR	DRWSEC	DRWTK	DRWWRM	EXBK	EX	FB	FD	FFD	FPEB	FTK	FTK V	ID	INVFRM	MIP	P	PTOWB	RD	RECTK	RT	SCPDRW	TD	TOTSSS	TVR	V	VTK	
•	•	•	•	•	•	•											•	•			•	•				•	STD		•	STD/•							•

Construction Upgrades

APC	ET	PE
•		•

Door Options

DPSRR
•

¹ RECTKALL not available, RECTKBK is standard, and RECTKL/RECTKR are available

Price Point

1

2

3

4

5

6

7

8

9

10

11

12

BASE QUARTER ROUND END SHELF

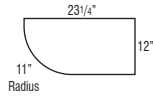
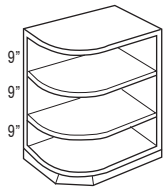

BQRES

1114	1114	1114	1114	1114	1114	1114	1114	1114	1114	1114	1114	1114
------	------	------	------	------	------	------	------	------	------	------	------	------

- Reversible.
- 12" wide x 23 1/4" deep x 11" radius.
- Separate pedestal base included.
- Angled pedestal design allows easier application of matching toeboard.
- Veneer construction finished to match cabinet face frame.
- Veneer on a 3/4" furniture board core.
- Matching interior.
- Cabinet is to be installed behind the face frame of the adjacent 24" deep base cabinet, features two unfinished back panels.
- If ordered with Heirloom Technique, will not feature sand-through characteristics.

MODIFICATIONS

No modifications available for these products.

Construction Upgrades

APC	ET	PE
•		

BASE OPEN CABINET with PLAIN BACK

15", 18", 24", 30", or 36"

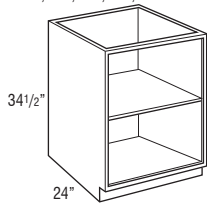

BOCP15	1448	1448	1448	1448	1448	1448	1448	1448	1448	1448	1448	1448
BOCP18	1480	1480	1480	1480	1480	1480	1480	1480	1480	1480	1480	1480
BOCP24	1547	1547	1547	1547	1547	1547	1547	1547	1547	1547	1547	1547
BOCP30	1613	1613	1613	1613	1613	1613	1613	1613	1613	1613	1613	1613
BOCP36	1681	1681	1681	1681	1681	1681	1681	1681	1681	1681	1681	1681

- If ordered with Heirloom Technique, will not feature sand-through characteristics.
- To change the top rail valance, specify one of the following modifications: Arch (TVRAV), Furniture (TVRFV), or Straight Valance (TVRVV).

Custom Modifications

AUTH	CBO	CCO	CFNTD	CFP	CFRMO	CH	CMAT	CND	CW	DRT	DRWPWR	DRWSEC	DRWTK	DRWWRM	EXBK	EX	FB	FD	FFD	FPEB	FTK	FTK_V	ID	INVFRM	MIP	P	PTOWB	RD	RECTK	RT	SCPDRW	TD	TOTSSS	TVR_V	VTK
•	STD				•	•			•				• ¹		•	•		STD		•	•	•				STD	•		•					•	•

Construction Upgrades

APC	ET	PE

Door Options

DPSRR

¹ Not available on 15" wide

169

BASE CABINETS

TABLE OF CONTENTS – UNIVERSAL ACCESS CABINETS

Universal Access Base Cabinets with Adjustable Shelves171
 Universal Access Sink Base171
 Universal Access Super Lazy Susan173
 Universal Access Drawer Base173
 Universal Access Microwave with Deep Drawer173
 Universal Access Vanity Wall Sink, Removable Sink Base174

UNIVERSAL ACCESS CABINETS

UNIVERSAL ACCESS NOMENCLATURE

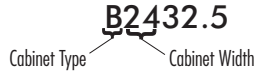

MODIFICATIONS GRID KEY

- Available
- STD Standard on these cabinets
-  5 Day Express Response Item

CONSTRUCTION UPGRADES

Mod.	Description
APC	All-plywood Construction
PE	Plywood Ends

DOOR OPTIONS

Mod.	Description
DPSRR	Door Panel - Solid Reverse Raised
MFO	Modified Full Overlay

CUSTOM MODIFICATIONS

Mod.	Description	Mod.	Description
AUTHB	Authentic Ends - Both	EXBKL	End Extended Back - Left
AUTHL	Authentic End - Left	EXBKR	End Extended Back - Right
AUTHR	Authentic End - Right	EXL	Extended Stile - Left
CBO	Cabinet Box Only	EXR	Extended Stile - Right
CCO	Cabinet Case Only	FB	Finished Ends
CFNTO	Cabinet Front Only	FD	Full Depth Shelf
CFP	Cabinet False Panel	FPEB	Furniture Finished Plywood Ends
CFRMO	Cabinet Frame Only	ID	Increased Depth
CH	Custom Height	INVFRM	Inverted Frame
CMAT	CabMat™	MIP	Matching Interior Plywood
CND	Cabinet with No Door, with Drawer	RD	Reduced Depth
CW	Custom Width	RT	Installed Roll Tray
DRT	Deep Roll Tray	SCPDRW	Scooped Drawer
DRWPWR	PowerGlide™ Compact Drawer Outlet	TOTSSS	Tilt-out Tray, Stainless Steel Slim
DRWSEC	Biometric Secured Drawer	VTK	Void Toekick
DRWWRM	Warming Drawer		

All Universal Access Cabinets are 32 1/2" high unless otherwise noted.

Standard Universal Access toekick is 4 1/2" tall, which will align with base cabinets. Cabinets are shipped with an unfinished toekick. Finished toekicks in matching wood veneer or laminate must be ordered separately and field installed.

Full depth shelf kits are available for field installation. See page 306.

UNIVERSAL ACCESS BASE, SINGLE DOOR

12", 15", 18", or 21"

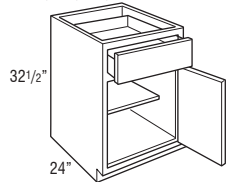

	Price Point	1	2	3	4	5	6	7	8	9	10	11	12
B1232.5 L or R		869	914	931	946	963	979	1036	1072	1109	1147	1177	1269
B1532.5 L or R		921	971	986	999	1014	1027	1089	1124	1166	1205	1235	1334
B1832.5 L or R		945	999	1023	1045	1067	1090	1149	1189	1235	1275	1310	1412
B2132.5 L or R		1011	1071	1098	1123	1150	1176	1241	1288	1334	1379	1412	1528

• Adjustable 15" deep shelf.

Custom Modifications

AUTH	CBO	CCO	CFNTO	CFP	CFRMO	CH	CMAT	CND	CW	DRT	DRWPWR	DRWSEC	DRWWRM	EXBK	EX	FB	FD	FPEB	ID	INVFRM	MIP	RD	RT	SCPDRW	TOTSSS	VTK
		•	•	•	•						• ¹	• ¹		•	•	•	•			•	•	•	•			•

Construction Upgrades

APC	PE
•	•

Door Options

DPSRR	MFO
•	

¹ Not available on 12" and 15" wide

UNIVERSAL ACCESS BASE, DOUBLE DOOR

24", 30", or 36"

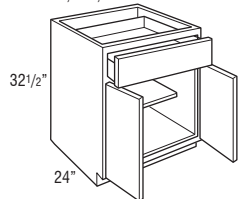

B2432.5	1228	1292	1307	1322	1336	1351	1426	1482	1538	1587	1631	1763
B3032.5	1348	1430	1471	1510	1549	1588	1682	1743	1808	1872	1923	2076
B3632.5	1418	1509	1557	1605	1653	1701	1799	1864	1942	2004	2059	2229

• Adjustable 15" deep shelf.

Custom Modifications

AUTH	CBO	CCO	CFNTO	CFP	CFRMO	CH	CMAT	CND	CW	DRT	DRWPWR	DRWSEC	DRWWRM	EXBK	EX	FB	FD	FPEB	ID	INVFRM	MIP	RD	RT	SCPDRW	TOTSSS	VTK
		•	•	•	•						•	• ²		•	•	•	•			•	•	•	•			•

Construction Upgrades

APC	PE
•	•

Door Options

DPSRR	MFO
•	

¹ Not available on 24" wide

² Available only on 24" wide

UNIVERSAL ACCESS SINK BASE

30" or 36"

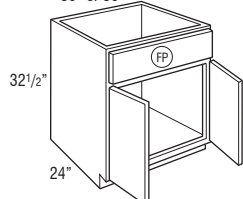

SB3032.5	978	1051	1110	1169	1229	1288	1366	1419	1476	1529	1570	1699
SB3632.5	1037	1108	1177	1247	1316	1385	1471	1533	1592	1648	1691	1836

• Mini Touch-up Kit (MTUK) included. MTUK includes small touch-up marker and small fill stick.

Custom Modifications

AUTH	CBO	CCO	CFNTO	CFP	CFRMO	CH	CMAT	CND	CW	DRT	DRWPWR	DRWSEC	DRWWRM	EXBK	EX	FB	FD	FPEB	ID	INVFRM	MIP	RD	RT	SCPDRW	TOTSSS	VTK
		•	•	STD	•			•	•	•				•	•	•	•			•	•	•	•			•

Construction Upgrades

APC	PE
•	•

Door Options

DPSRR	MFO
•	

(FP) = False Panel

UNIVERSAL ACCESS SINK BASE with TILT-OUT TRAYS

30" or 36"

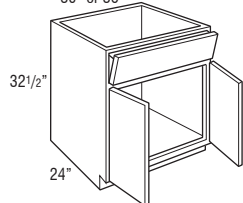

SB3032.5ST	1230	1319	1380	1440	1501	1560	1659	1725	1792	1859	1904	2063
SB3632.5ST	1291	1381	1450	1520	1589	1659	1758	1828	1902	1972	2026	2196

• Tilt-out trays are stain resistant, moisture resistant plastic to allow storage of sponges and other cleaning materials.

• Mini Touch-up Kit (MTUK) included. MTUK includes small touch-up marker and small fill stick.

• Includes two tilt-out trays.

• Tilt-out trays are also available as an accessory for field installation. See page 315.

Custom Modifications

AUTH	CBO	CCO	CFNTO	CFP	CFRMO	CH	CMAT	CND	CW	DRT	DRWPWR	DRWSEC	DRWWRM	EXBK	EX	FB	FD	FPEB	ID	INVFRM	MIP	RD	RT	SCPDRW	TOTSSS	VTK
		•	•	•	•			•	•	•				•	•	•	•			•	•	•	•			•

Construction Upgrades

APC	PE
•	•

Door Options

DPSRR	MFO
•	

UNIVERSAL ACCESS SINK BASE, REMOVABLE

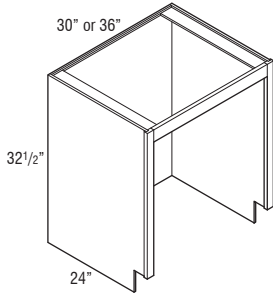
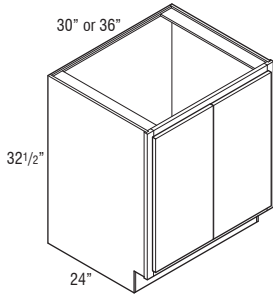

Shown with front, cabinet bottom, and toekick removed.

Price Point

	1	2	3	4	5	6	7	8	9	10	11	12
UASBRF3032.5	1055	1186	1238	1289	1341	1391	1481	1539	1603	1659	1706	1845
UASBRF3632.5	1083	1247	1301	1356	1411	1465	1553	1617	1680	1739	1784	1934

- Cabinet must be supported on both sides. For end of run, cabinet must be anchored to the floor.
- Front, cabinet bottom, and toekick are removable.

Custom Modifications

AUTH	CBO	CCO	CFNTD	CFP	CFRMO	CH	CMAT	CND	CW	DRT	DRWPWR	DRWSEC	DRWWRM	EXBK	EX	FB	FD	FPEB	ID	INVERM	MIP	RD	RT	SCPDRW	TOTSSS	VTK
		•						•	•							•		•			•					

Construction Upgrades

APC	PE
STD	

Door Options

DPSRR	MFO
•	

UNIVERSAL ACCESS SINK BASE, REMOVABLE, 34 1/2" HIGH

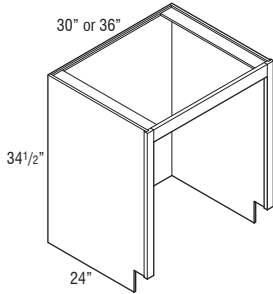
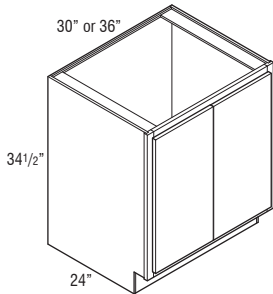

Shown with front, cabinet bottom, and toekick removed.

	1	2	3	4	5	6	7	8	9	10	11	12
UASBRF30	1055	1186	1238	1289	1341	1391	1481	1539	1603	1659	1706	1845
UASBRF36	1083	1247	1301	1356	1411	1465	1553	1617	1680	1739	1784	1934

- Cabinet must be supported on both sides. For end of run, cabinet must be anchored to the floor.
- Front, cabinet bottom, and toekick are removable.

Custom Modifications

AUTH	CBO	CCO	CFNTD	CFP	CFRMO	CH	CMAT	CND	CW	DRT	DRWPWR	DRWSEC	DRWWRM	EXBK	EX	FB	FD	FPEB	ID	INVERM	MIP	RD	RT	SCPDRW	TOTSSS	VTK
•		•						•	•							•		•			•					

Construction Upgrades

APC	PE
STD	

Door Options

DPSRR	MFO
•	

UNIVERSAL ACCESS SUPER LAZY SUSAN

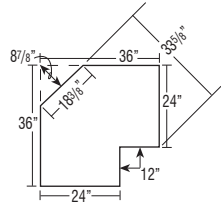
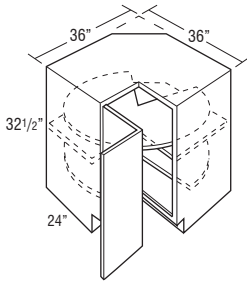

Due to fixed shelf mounting, susans cannot be retrofitted.

SLS3632.5 L or R	2040	2164	2458	2753	3048	3341	3539	3678	3825	3970	4070	4408
-------------------------	------	------	------	------	------	------	------	------	------	------	------	------

- SLS3632.5 L or R wall width is 36" x 36".
- Susan is 32" diameter.
- Features two plywood susans with a 1" plywood lip. Lower susan is mounted to floor. Upper susan is mounted to fixed shelf. Fixed shelf is 1/2" thick laminated furniture board.
- Decorative hardware screws must be countersunk to prevent scratching adjacent cabinets and face frame of SLS.
- Integrated soft-close hinge not included.

Custom Modifications

AUTH	CBO	CCO	CFNTO	CFP	CFRMO	CH	CMAT	CND	CW	DRT	DRWPWR	DRWSEC	DRWWRM	EXBK	EX	FB	FD	FPEB	ID	INVFRM	MIP	RD	RT	SCPDRW	TOTSSS	VTK

Construction Upgrades

APC	PE

Door Options

DPSRR	MFO

UNIVERSAL ACCESS THREE DRAWER BASE

15", 18", or 24"

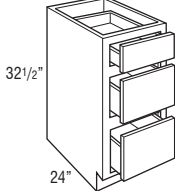

3DB1532.5	1511	1519	1532	1544	1557	1569	1645	1704	1761	1809	1850	1996
3DB1832.5	1569	1577	1597	1617	1637	1658	1743	1801	1861	1917	1962	2115
3DB2432.5	1724	1733	1753	1773	1793	1812	1906	1975	2045	2108	2159	2330

- 1 shallow and 2 deep drawers.
- Exterior height for bottom two drawer boxes is 6 3/8".

Custom Modifications

AUTH	CBO	CCO	CFNTO	CFP	CFRMO	CH	CMAT	CND	CW	DRT	DRWPWR	DRWSEC	DRWWRM	EXBK	EX	FB	FD	FPEB	ID	INVFRM	MIP	RD	RT	SCPDRW	TOTSSS	VTK

Construction Upgrades

APC	PE

Door Options

DPSRR	MFO

¹ Not available on 15" wide

UNIVERSAL ACCESS BASE MICROWAVE with DEEP DRAWER

27" or 30"

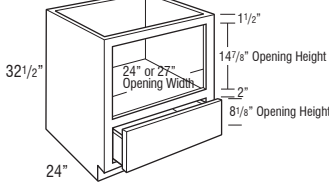

BMW2732.5DD	1798	1807	1814	1821	1829	1836	1905	1979	2054	2122	2185	2360
BMW3032.5DD	1887	1896	1904	1912	1920	1928	2001	2078	2157	2229	2294	2479

- 1 deep drawer below microwave.
- Reinforced plywood floor.

Custom Modifications

AUTH	CBO	CCO	CFNTO	CFP	CFRMO	CH	CMAT	CND	CW	DRT	DRWPWR	DRWSEC	DRWWRM	EXBK	EX	FB	FD	FPEB	ID	INVFRM	MIP	RD	RT	SCPDRW	TOTSSS	VTK

Construction Upgrades

APC	PE

Door Options

DPSRR	MFO

UNIVERSAL ACCESS DESK LEG

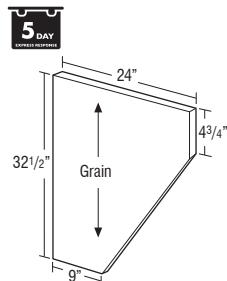

VDL32.5WD	228	228	228	228	228	228	228	228	228	228	228	228
------------------	-----	-----	-----	-----	-----	-----	-----	-----	-----	-----	-----	-----

- VDL32.5WD in Stains: 3/4" thick veneered furniture board.
- VDL32.5WD in Paints: 3/4" thick veneered or solid furniture board.
- All panels are finished two sides and front edge.

MODIFICATIONS

No modifications available for these products.

Finish Techniques

Heirlooming

Species Availability

Rustic Alder	Cherry	Rustic Hickory	Laminate	Maple	Oak
Alder		Hickory	box color		

VANITY WALL SINK

27", 30", 33", or 39"

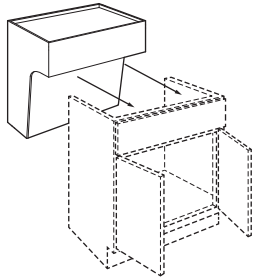
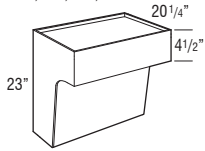

Price Point	1	2	3	4	5	6	7	8	9	10	11	12
VWS2723	1016	1016	1016	1016	1016	1016	1016	1016	1016	1016	1016	1016
VWS3023	1034	1034	1034	1034	1034	1034	1034	1034	1034	1034	1034	1034
VWS3323	1052	1052	1052	1052	1052	1052	1052	1052	1052	1052	1052	1052
VWS3923	1089	1089	1089	1089	1089	1089	1089	1089	1089	1089	1089	1089

- Recommended installation height of 32" high with 9" of clearance below.
- Front panel is attached with clips for easy removal for access to plumbing.
- Finished veneer plywood exterior and interior.
- For proper installation, cabinet must be secured on each side through both the top and bottom of the back panel into wall studs. Installation instructions and required 3 1/2" installation screws included, standard 2 1/2" installation screws are not sufficient in this application.
- Features a full cabinet top that can be routed for sink installation.
- Approximate weight limit is 400 lbs. per cabinet (includes weight of the cabinet, countertop and contents). Proper installation is required and additional bracing may be required.
- Includes connector clips to mount the sink base to the Removable Vanity Sink Base (RVWS..32). RVWS..32 not included, see below.

Custom Modifications

AUTH	CBO	CCO	CFNTD	CFP	CFRMO	CH	CMAT	CND	CW	DRT	DRWPWR	DRWSEC	DRWWRM	EXBK	EX	FB	FD	FPEB	ID	INVFRM	MIP	RD	RT	SCPDRW	TOTSSS	VTK
																			STD			STD				

Construction Upgrades

APC	PE

Door Options

DPSRR	MFO

REMOVABLE VANITY SINK BASE, 21" DEEP

30", 33", or 36"

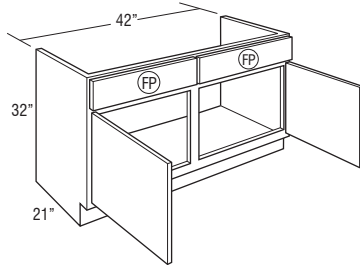
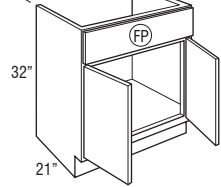

RVWS3032	1055	1186	1238	1289	1341	1391	1481	1539	1603	1659	1706	1845
RVWS3332	1070	1210	1266	1322	1378	1432	1518	1580	1643	1699	1747	1895
RVWS3632	1083	1247	1301	1356	1411	1465	1553	1617	1680	1739	1784	1934

RVWS4232	1229	1384	1431	1478	1525	1572	1665	1733	1802	1868	1916	2080
-----------------	------	------	------	------	------	------	------	------	------	------	------	------

- Must be ordered with Vanity Wall Sink (VWS..23), not designed to be a stand-alone unit.
 - RVWS3032 is compatible with VWS2723
 - RVWS3332 is compatible with VWS3023
 - RVWS3632 is compatible with VWS3323
 - RVWS4232 is compatible with VWS3923
- Cabinet is able to be removed for handicap accessible use.
- Includes connector clips to mount the sink base to the Vanity Wall Sink (VWS..23).
- Available with AUTHL, AUTHR, and AUTHB modifications.

Custom Modifications

AUTH	CBO	CCO	CFNTD	CFP	CFRMO	CH	CMAT	CND	CW	DRT	DRWPWR	DRWSEC	DRWWRM	EXBK	EX	FB	FD	FPEB	ID	INVFRM	MIP	RD	RT	SCPDRW	TOTSSS	VTK
				•	•	STD		•											STD			•				

Construction Upgrades

APC	PE
STD	

Door Options

DPSRR	MFO
•	

Ⓢ = False Panel

TABLE OF CONTENTS – TALL CABINETS

Tall Cabinets with Shelves	176
Tall Cabinets with Roll Trays	181
Utility Organizer Cabinets	184
Pantry Cabinets	186
Tall Appliance Cabinets	191

TALL CABINET NOMENCLATURE

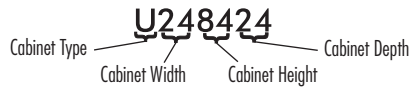

MODIFICATIONS GRID KEY

- Available
- STD Standard on these cabinets

CONSTRUCTION UPGRADES

Mod.	Description
APC	All-plywood Construction
ET	EasyTrax™
PE	Plywood Ends

DOOR OPTIONS

Mod.	Description
CG, CG.TOP	Cut-for-glass Doors
DPSRR	Door Panel - Solid Reverse Raised
MFO	Modified Full Overlay

CUSTOM MODIFICATIONS

Mod.	Description	Mod.	Description
ACS	Appliance Cut-out, Single	FB	Finished Ends
ADDTK	Add Toekick	FD	Full Depth Shelf
AUTHB	Authentic Ends - Both	FFDL	Face Frame and Door on End - Left
AUTHL	Authentic End - Left	FFDR	Face Frame and Door on End - Right
AUTHR	Authentic End - Right	FPEB	Furniture Finished Plywood Ends
CBO	Cabinet Box Only	FTK	Flush Toekick
CCO	Cabinet Case Only	FTKAV	Flush Toekick Arch
CFNTO	Cabinet Front Only	FTKRV	Flush Toekick Furniture
CFRMO	Cabinet Frame Only	ID	Increased Depth
CH	Custom Height	INVFRM	Inverted Frame
CND	Cabinet with No Door, with Drawer	MIP	Matching Interior Plywood
CW	Custom Width	RD	Reduced Depth
DRT	Deep Roll Tray	RECTKL	Recessed Toekick - Left
DRWTK	Toekick Drawer	RECTKR	Recessed Toekick - Right
DRWWRM	Warming Drawer	RT	Installed Roll Tray
EXBKL	End Extended Back - Left	TD	Tray Dividers
EXBKR	End Extended Back - Right	TKP	Loose Toekick
EXL	Extended Stile - Left	VTK	Void Toekick
EXR	Extended Stile - Right		

Reduced Depth available to 6" on tall cabinets without drawers or roll trays. Reduced Depth available to 12" on tall cabinets with drawers or roll trays. Depths reduced to 6"-8" will not include toekick/pedestal.

Utility cabinets with depths of 12" or less must be installed to studs in wall or onto the end of another tall cabinet.

Separate pedestal base included but may be packaged separately on 93" and 96" tall. Pedestal is designed to create a Recessed Left or Right Toekick application during field installation, or can be centered. Pedestal must be covered with toeboard material. Pedestal toekick grain runs horizontally.

Remember to apply FPEB or add an end panel skin to all tall cabinets when installing next to a base and a wall cabinet to avoid notching the countertop around the face frame.

FPEB modification or end panel skin is recommended when placing a tall cabinet adjacent to a shallower depth cabinet in a position where the end will be exposed; this will aid in adjacent countertop installation and moulding application.

Tall mitered door styles and laminate door styles will feature one center panel; other door styles will feature two center panels.

Horizontal grain doors greater than 48" high will be two doors doweled together.

UTILITY, 66" TALL, 12" DEEP

9", 12", 15", 18", 21", or 24"

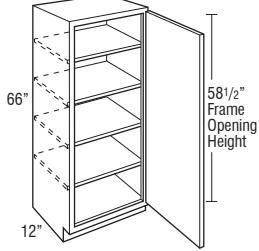

24", 27", 30", 33", or 36"

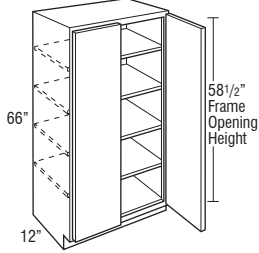

Price Point

	1	2	3	4	5	6	7	8	9	10	11	12
U96612 L or R	1082	1272	1314	1354	1394	1435	1520	1580	1643	1704	1751	1897
U126612 L or R	1082	1272	1314	1354	1394	1435	1520	1580	1643	1704	1751	1897
U156612 L or R	1124	1327	1370	1411	1453	1494	1587	1645	1712	1776	1823	1976
U186612 L or R	1188	1390	1440	1491	1541	1590	1689	1755	1821	1889	1940	2102
U216612 L or R	1307	1530	1585	1640	1695	1748	1855	1926	2006	2076	2135	2312
U246612 L or R	1369	1578	1645	1711	1779	1845	1954	2034	2112	2190	2251	2436

U246612	1431	1624	1704	1782	1860	1939	2052	2136	2220	2303	2364	2564
U276612	1503	1719	1833	1948	2062	2175	2307	2398	2494	2586	2653	2873
U306612	1574	1816	1966	2115	2264	2412	2561	2658	2765	2867	2943	3188
U336612	1691	1952	2112	2271	2432	2591	2750	2857	2972	3080	3166	3426
U366612	1812	2089	2260	2430	2601	2771	2939	3053	3176	3292	3382	3664

• Recommended for stacking with wall cabinets to create tall utility cabinets for designs greater than 96". Because of exposed seam when stacking, be sure to use an end panel skin to connect the seam on the side of the stacked cabinets. FPFB is not recommended.

Custom Modifications

ACS	ADDTK	AUTH	CBO	CCO	CFNTO	CFRMO	CH	CND	CW	DRT	DRWTK	DRWWRM	EXBK	EX	FB	FFD	FPFB	FTK	FTK_V	ID	INVFRM	MIP	RD	RECTK	RT	TD	TKP	VTK	
							• ¹			• ²					•	•				• ³			•	•				•	•

Construction Upgrades

APC	ET	PE
•		•

Door Options

CG	CG.TOP	DPSRR	MFO
		•	•

¹ Minimum height is 46 3/4"

² Not available on 9" and 24" (2 doors) wide

³ Not available on 9" and 12" wide

UTILITY, 66" TALL, 24" DEEP

9", 12", 15", 18", 21", or 24"

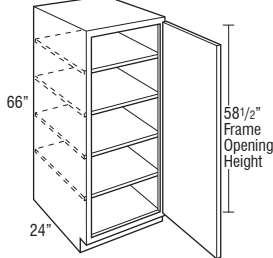

24", 27", 30", 33", or 36"

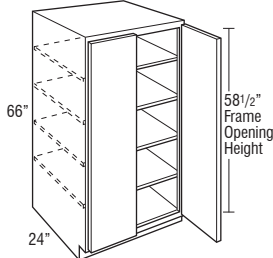

U96624 L or R	1118	1303	1356	1410	1464	1518	1611	1674	1739	1803	1852	2009
U126624 L or R	1118	1303	1356	1410	1464	1518	1611	1674	1739	1803	1852	2009
U156624 L or R	1165	1356	1412	1468	1524	1580	1679	1747	1814	1880	1932	2093
U186624 L or R	1282	1493	1549	1605	1661	1716	1823	1894	1968	2042	2097	2270
U216624 L or R	1410	1643	1706	1767	1829	1891	2006	2084	2166	2248	2307	2500
U246624 L or R	1607	1855	1895	1934	1975	2014	2135	2218	2308	2392	2457	2663

U246624	1803	2064	2083	2101	2119	2137	2264	2356	2448	2536	2606	2822
U276624	1921	2216	2262	2307	2352	2397	2544	2644	2750	2848	2925	3170
U306624	2038	2365	2439	2513	2587	2661	2821	2932	3050	3161	3246	3516
U336624	2193	2545	2623	2701	2780	2857	3031	3152	3277	3395	3489	3777
U366624	2342	2722	2806	2888	2972	3055	3240	3369	3501	3627	3728	4041

• Recommended for stacking with wall cabinets to create tall utility cabinets for designs greater than 96". Because of exposed seam when stacking, be sure to use an end panel skin to connect the seam on the side of the stacked cabinets. FPFB is not recommended.

Custom Modifications

ACS	ADDTK	AUTH	CBO	CCO	CFNTO	CFRMO	CH	CND	CW	DRT	DRWTK	DRWWRM	EXBK	EX	FB	FFD	FPFB	FTK	FTK_V	ID	INVFRM	MIP	RD	RECTK	RT	TD	TKP	VTK	
							• ¹			• ²	• ³				•	•				• ⁴			•	•	• ⁵			•	•

Construction Upgrades

APC	ET	PE
•		•

Door Options

CG	CG.TOP	DPSRR	MFO
		•	•

¹ Minimum height is 46 3/4"

² Not available on 9" and 24" (2 doors) wide

³ Not available on 9", 12", and 15" wide

⁴ Not available on 9" and 12" wide

⁵ Not available on 9" wide

**UTILITY, 84", 87", or 90" TALL,
12" DEEP**

9", 12", 15", 18", 21", or 24"

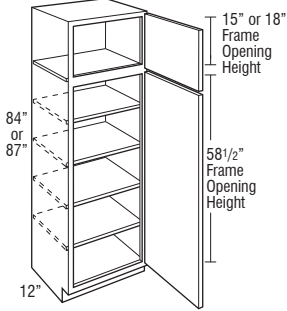

24", 27", 30", 33", or 36"

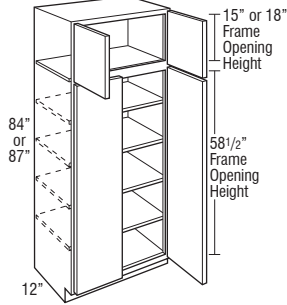

9", 12", 15", 18", 21", or 24"

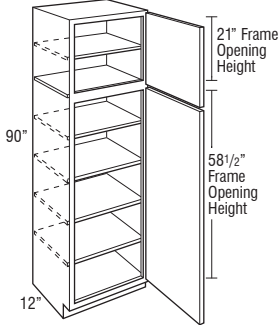

24", 27", 30", 33", or 36"

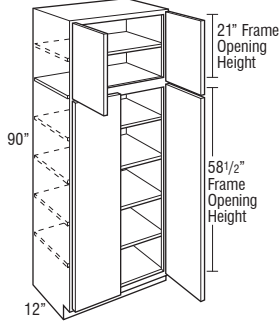

Price Point	1	2	3	4	5	6	7	8	9	10	11	12
U98412 L or R	1203	1415	1459	1504	1549	1594	1689	1755	1826	1893	1945	2108
U128412 L or R	1203	1415	1459	1504	1549	1594	1689	1755	1826	1893	1945	2108
U158412 L or R	1250	1475	1522	1568	1614	1660	1763	1828	1902	1973	2026	2195
U188412 L or R	1320	1544	1600	1656	1712	1767	1876	1949	2024	2099	2156	2336
U218412 L or R	1453	1700	1761	1821	1882	1942	2062	2140	2228	2307	2372	2569
U248412 L or R	1521	1754	1828	1902	1976	2050	2171	2259	2348	2433	2501	2707
U98712 L or R	1232	1435	1485	1536	1586	1636	1737	1805	1878	1945	1998	2167
U128712 L or R	1232	1435	1485	1536	1586	1636	1737	1805	1878	1945	1998	2167
U158712 L or R	1306	1495	1548	1600	1653	1706	1810	1880	1956	2027	2082	2255
U188712 L or R	1375	1584	1641	1698	1755	1812	1925	2000	2078	2153	2211	2396
U218712 L or R	1513	1739	1803	1867	1931	1995	2115	2197	2286	2368	2432	2635
U248712 L or R	1572	1822	1891	1959	2027	2096	2222	2312	2402	2489	2556	2769

U248412	1590	1804	1892	1979	2066	2153	2280	2373	2467	2558	2628	2848
U278412	1671	1911	2037	2164	2290	2417	2563	2664	2772	2873	2948	3192
U308412	1748	2017	2183	2349	2514	2679	2846	2952	3073	3185	3272	3541
U338412	1880	2169	2348	2524	2701	2878	3055	3174	3302	3423	3518	3806
U368412	2013	2321	2511	2700	2890	3079	3266	3392	3529	3658	3759	4071
U248712	1634	1904	1978	2051	2125	2197	2327	2420	2518	2608	2680	2905
U278712	1788	2104	2221	2336	2452	2567	2724	2831	2943	3051	3133	3396
U308712	1800	2137	2286	2434	2583	2731	2902	3012	3133	3246	3336	3613
U338712	1936	2298	2458	2617	2776	2936	3116	3237	3367	3488	3583	3882
U368712	2072	2460	2629	2798	2967	3136	3330	3456	3596	3728	3830	4150

U99012 L or R	1278	1458	1514	1569	1625	1680	1783	1856	1925	1997	2053	2225
U129012 L or R	1278	1458	1514	1569	1625	1680	1783	1856	1925	1997	2053	2225
U159012 L or R	1332	1519	1577	1634	1692	1749	1859	1930	2008	2081	2139	2317
U189012 L or R	1403	1617	1678	1738	1799	1859	1972	2048	2131	2206	2266	2455
U219012 L or R	1543	1781	1848	1914	1980	2046	2167	2257	2344	2427	2492	2699
U249012 L or R	1622	1891	1954	2017	2081	2144	2272	2361	2454	2545	2612	2829

U249012	1702	2009	2068	2125	2182	2239	2376	2467	2568	2660	2732	2962
U279012	1914	2259	2374	2489	2604	2718	2882	2995	3115	3229	3316	3593
U309012	1850	2183	2333	2483	2633	2783	2955	3069	3191	3307	3398	3683
U339012	1987	2344	2507	2668	2829	2990	3173	3296	3428	3554	3650	3955
U369012	2122	2504	2678	2850	3023	3195	3392	3520	3664	3797	3899	4226

Custom Modifications

ACS	ADDTK	AUTH	CBO	CCO	CFNTO	CFRMO	CH	CND	CW	DRT	DRWTK	DRWWRM	EXBK	EX	FB	FFD	FPEB	FTK	FTK_V	ID	INVRM	MIP	RD	RECTK	RT	TD	TKP	VTK	
								1			2									3									

Construction Upgrades

APC	ET	PE

Door Options

CG	CG.TOP	DPSRR	MFO

¹ Minimum height is 78"
² Not available on 9" and 24" (2 doors) wide
³ Not available on 9" and 12" wide

**UTILITY, 93" or 96" TALL,
12" DEEP**

9", 12", 15", 18", 21", or 24"

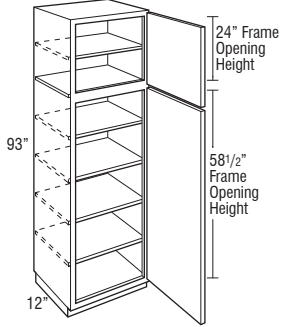

24", 27", 30", 33", or 36"

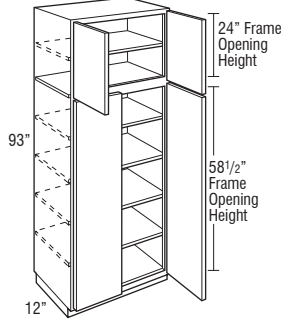

9", 12", 15", 18", 21", or 24"

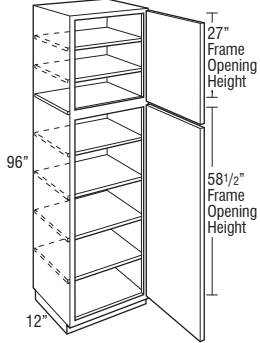

24", 27", 30", 33", or 36"

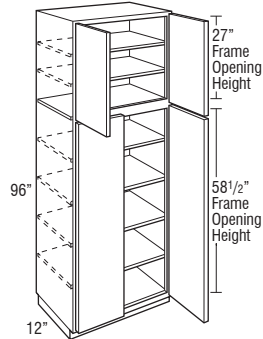

Price Point

	1	2	3	4	5	6	7	8	9	10	11	12
U99312 L or R	1365	1513	1578	1642	1707	1771	1878	1951	2028	2104	2159	2340
U129312 L or R	1365	1513	1578	1642	1707	1771	1878	1951	2028	2104	2159	2340
U159312 L or R	1421	1575	1642	1709	1776	1842	1953	2031	2112	2191	2251	2438
U189312 L or R	1495	1697	1760	1821	1884	1945	2062	2140	2229	2314	2372	2568
U219312 L or R	1646	1864	1933	2001	2071	2139	2270	2356	2451	2544	2610	2826
U249312 L or R	1727	2018	2071	2124	2176	2229	2364	2454	2554	2647	2719	2942

U249312	1784	2106	2159	2212	2265	2317	2457	2554	2654	2751	2826	3063
U279312	1867	2203	2303	2402	2502	2602	2760	2867	2986	3091	3175	3441
U309312	1947	2297	2445	2592	2738	2885	3063	3184	3311	3428	3524	3818
U339312	2094	2472	2630	2787	2944	3101	3289	3419	3556	3685	3786	4100
U369312	2239	2642	2810	2978	3146	3314	3518	3652	3798	3939	4044	4383

U99612 L or R	1365	1513	1578	1642	1707	1771	1878	1951	2028	2104	2159	2340
U129612 L or R	1365	1513	1578	1642	1707	1771	1878	1951	2028	2104	2159	2340
U159612 L or R	1421	1575	1642	1709	1776	1842	1953	2031	2112	2191	2251	2438
U189612 L or R	1495	1697	1760	1821	1884	1945	2062	2140	2229	2314	2372	2568
U219612 L or R	1646	1864	1933	2001	2071	2139	2270	2356	2451	2544	2610	2826
U249612 L or R	1727	2018	2071	2124	2176	2229	2364	2454	2554	2647	2719	2942

U249612	1761	2078	2138	2197	2258	2317	2457	2554	2654	2751	2826	3063
U279612	1860	2195	2297	2399	2501	2602	2760	2867	2986	3091	3175	3441
U309612	1962	2315	2458	2601	2743	2885	3063	3184	3311	3428	3524	3818
U339612	2111	2491	2644	2797	2949	3101	3289	3419	3556	3685	3786	4100
U369612	2259	2666	2828	2990	3153	3314	3518	3652	3798	3939	4044	4383

Custom Modifications

ACS	ADDTK	AUTH	CBO	CCO	CFNTO	CFRMO	CH	CND	CW	DRT	DRWTK	DRWWRM	EXBK	EX	FB	FFD	FPEB	FTK	FTK_V	ID	INFRM	MIP	RD	RECTK	RT	TD	TKP	VTK	

Construction Upgrades

APC	ET	PE

Door Options

CG	CG.TOP	DPSRR	MFO

¹ Not available on 9" and 24" (2 doors) wide

² Not available on 9" and 12" wide

**UTILITY, 84", 87", or 90" TALL,
24" DEEP**

9", 12", 15", 18", 21", or 24"

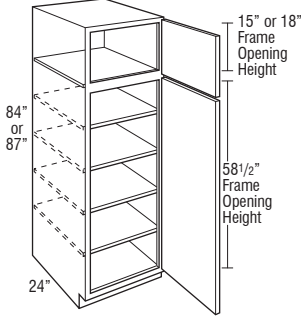

24", 27", 30", 33", or 36"

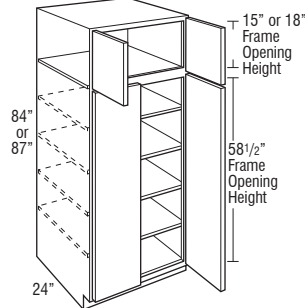

9", 12", 15", 18", 21", or 24"

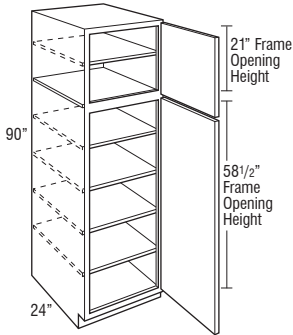

24", 27", 30", 33", or 36"

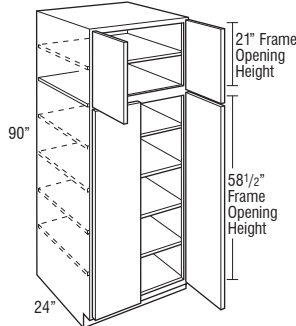

Price Point	1	2	3	4	5	6	7	8	9	10	11	12
U98424 L or R	1203	1419	1486	1553	1621	1687	1790	1860	1933	2004	2059	2233
U128424 L or R	1203	1419	1486	1553	1621	1687	1790	1860	1933	2004	2059	2233
U158424 L or R	1254	1481	1550	1618	1688	1756	1866	1942	2016	2089	2147	2325
U188424 L or R	1425	1659	1721	1783	1845	1906	2026	2104	2187	2268	2330	2522
U218424 L or R	1566	1826	1895	1963	2032	2100	2229	2316	2406	2498	2564	2778
U248424 L or R	1786	2061	2106	2149	2194	2238	2372	2465	2565	2658	2729	2959
U98724 L or R	1250	1472	1537	1602	1667	1732	1837	1911	1984	2057	2113	2290
U128724 L or R	1250	1472	1537	1602	1667	1732	1837	1911	1984	2057	2113	2290
U158724 L or R	1300	1533	1600	1668	1735	1802	1912	1989	2070	2145	2202	2386
U188724 L or R	1475	1697	1761	1824	1888	1952	2070	2153	2236	2320	2382	2580
U218724 L or R	1620	1865	1935	2006	2076	2147	2276	2367	2461	2551	2621	2837
U248724 L or R	1833	2124	2163	2202	2241	2280	2419	2513	2616	2712	2783	3016

U248424	2004	2294	2314	2334	2354	2374	2516	2617	2722	2818	2896	3136
U278424	2134	2462	2512	2563	2613	2663	2826	2938	3055	3164	3251	3522
U308424	2265	2629	2712	2793	2875	2957	3135	3258	3389	3512	3606	3905
U338424	2436	2827	2914	3002	3089	3175	3368	3501	3641	3771	3876	4197
U368424	2602	3023	3116	3209	3302	3395	3601	3743	3891	4030	4143	4489
U248724	2043	2376	2386	2396	2406	2416	2560	2661	2770	2868	2946	3190
U278724	2181	2554	2594	2633	2672	2712	2875	2990	3109	3220	3307	3583
U308724	2317	2729	2800	2869	2939	3008	3189	3316	3448	3573	3669	3975
U338724	2491	2938	3012	3084	3158	3231	3427	3562	3704	3837	3942	4269
U368724	2663	3142	3220	3297	3375	3452	3664	3808	3958	4100	4216	4564

U99024 L or R	1294	1495	1566	1636	1707	1776	1884	1959	2034	2110	2167	2349
U129024 L or R	1294	1495	1566	1636	1707	1776	1884	1959	2034	2110	2167	2349
U159024 L or R	1348	1558	1631	1704	1776	1848	1958	2040	2121	2199	2257	2447
U189024 L or R	1522	1732	1798	1864	1930	1995	2115	2197	2285	2369	2433	2638
U219024 L or R	1674	1906	1979	2051	2124	2195	2325	2418	2512	2605	2676	2902
U249024 L or R	1880	2182	2218	2253	2289	2325	2463	2564	2666	2761	2836	3072

U249024	2082	2332	2368	2402	2438	2473	2603	2706	2813	2916	2997	3245
U279024	2225	2644	2673	2701	2729	2757	2923	3040	3161	3275	3364	3643
U309024	2369	2834	2890	2946	3002	3058	3244	3372	3507	3633	3732	4042
U339024	2544	3048	3108	3167	3227	3286	3483	3620	3768	3903	4008	4342
U369024	2722	3259	3323	3386	3450	3512	3725	3868	4023	4173	4284	4641

Custom Modifications

ACS	ADDTK	AUTH	CBO	CCO	CFNTO	CFRMO	CH	CND	CW	DRT	DRWTK	DRWWRM	EXBK	EX	FB	FFD	FPEB	FTK	FTK_V	ID	INVRM	MIP	RD	RECTK	RT	TD	TKP	VTK
							• ¹		• ²		• ³			•	•	•			• ⁴						• ⁵	•	•	•

Construction Upgrades

APC	ET	PE
•		•

Door Options

CG	CG.TOP	DPSRR	MFO
		•	•

¹ Minimum height is 78"
² Not available on 9" and 24" (2 doors) wide
³ Not available on 9", 12", and 15" wide
⁴ Not available on 9" and 12" wide
⁵ Not available on 9" wide

**UTILITY, 93" or 96" TALL,
24" DEEP**

9", 12", 15", 18", 21", or 24"

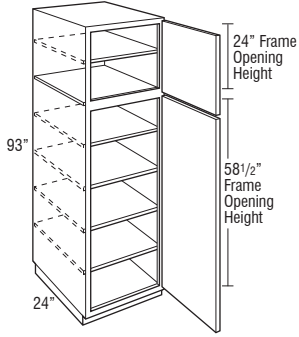

24", 27", 30", 33", or 36"

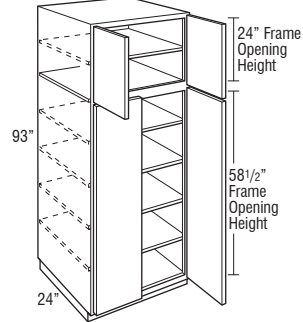

9", 12", 15", 18", 21", or 24"

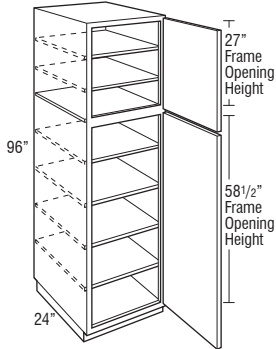

24", 27", 30", 33", or 36"

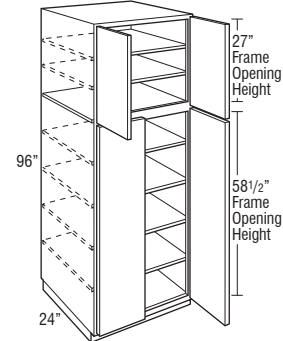

Price Point

	1	2	3	4	5	6	7	8	9	10	11	12
U99324 L or R	1381	1550	1628	1707	1785	1863	1978	2053	2134	2211	2272	2462
U129324 L or R	1381	1550	1628	1707	1785	1863	1978	2053	2134	2211	2272	2462
U159324 L or R	1439	1615	1697	1777	1859	1940	2059	2137	2224	2305	2369	2565
U189324 L or R	1617	1808	1876	1944	2013	2080	2205	2290	2384	2470	2537	2748
U219324 L or R	1748	1988	2064	2139	2214	2289	2426	2522	2622	2717	2788	3024
U249324 L or R	1971	2305	2332	2358	2384	2410	2555	2656	2761	2864	2939	3185

U249324	2225	2514	2519	2523	2528	2531	2685	2789	2902	3008	3090	3347
U279324	2430	2828	2832	2836	2840	2844	3017	3135	3261	3378	3471	3760
U309324	2577	3035	3065	3096	3126	3155	3345	3480	3619	3748	3852	4173
U339324	2769	3265	3296	3328	3359	3389	3593	3735	3885	4028	4136	4483
U369324	2960	3492	3525	3556	3588	3620	3840	3992	4152	4304	4420	4790

U99624 L or R	1381	1550	1628	1707	1785	1863	1978	2053	2134	2211	2272	2462
U129624 L or R	1381	1550	1628	1707	1785	1863	1978	2053	2134	2211	2272	2462
U159624 L or R	1439	1615	1697	1777	1859	1940	2059	2137	2224	2305	2369	2565
U189624 L or R	1617	1808	1876	1944	2013	2080	2205	2290	2384	2470	2537	2748
U219624 L or R	1748	1988	2064	2139	2214	2289	2426	2522	2622	2717	2788	3024
U249624 L or R	1971	2305	2332	2358	2384	2410	2555	2656	2761	2864	2939	3185

U249624	2164	2380	2418	2456	2494	2531	2685	2789	2902	3008	3090	3347
U279624	2314	2429	2547	2663	2780	2896	3017	3135	3261	3378	3471	3760
U309624	2577	3035	3065	3096	3126	3155	3345	3480	3619	3748	3852	4173
U339624	2769	3265	3296	3328	3359	3389	3593	3735	3885	4028	4136	4483
U369624	2960	3492	3525	3556	3588	3620	3840	3992	4152	4304	4420	4790

Custom Modifications

ACS	ADDTK	AUTH	CBO	CCO	CFNTO	CFRMO	CH	CND	CW	DRT	DRWTK	DRWWRM	EXBK	EX	FB	FFD	FPEB	FTK	FTK_V	ID	INFRM	MIP	RD	RECTK	RT	TD	TKP	VTK	

Construction Upgrades

APC	ET	PE

Door Options

CG	CG.TOP	DPSRR	MFO

¹ Not available on 9" and 24" (2 doors) wide

² Not available on 9" and 12" wide

³ Not available on 9" wide

**UTILITY with ROLL TRAYS,
66" TALL, 24" DEEP**

12", 15", 18", 21", or 24"

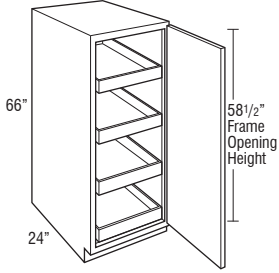

24", 27", 30", 33", or 36"

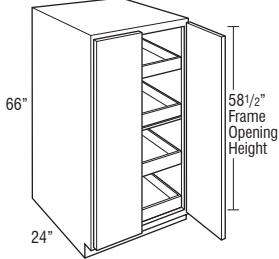

Price
Point

	1	2	3	4	5	6	7	8	9	10	11	12
U126624RT L or R	2240	2425	2478	2532	2586	2640	2733	2796	2861	2925	2974	3131
U156624RT L or R	2287	2478	2534	2590	2646	2702	2801	2869	2936	3002	3054	3215
U186624RT L or R	2404	2615	2671	2727	2783	2838	2945	3016	3090	3164	3219	3392
U216624RT L or R	2532	2765	2828	2889	2951	3013	3128	3206	3288	3370	3429	3622
U246624RT L or R	2729	2977	3017	3056	3097	3136	3257	3340	3430	3514	3579	3785

U246624RT	2925	3186	3205	3223	3241	3259	3386	3478	3570	3658	3728	3944
U276624RT	3043	3338	3384	3429	3474	3519	3666	3766	3872	3970	4047	4292
U306624RT	3160	3487	3561	3635	3709	3783	3943	4054	4172	4283	4368	4638
U336624RT	3315	3667	3745	3823	3902	3979	4153	4274	4399	4517	4611	4899
U366624RT	3464	3844	3928	4010	4094	4177	4362	4491	4623	4749	4850	5163

- Recommended for stacking with wall cabinets to create tall utility cabinets for designs greater than 96". Because of exposed seam when stacking, be sure to use an end panel skin to connect the seam on the side of the stacked cabinets. FPFB is not recommended.

Custom Modifications

ACS	ADDTK	AUTH	CBO	CCO	CFNTO	CFRMO	CH	CND	CW	DRT	DRWTK	DRWWRM	EXBK	EX	FB	FFD	FPFB	FTK	FTK_V	ID	INVFRM	MIP	RD	RECTK	RT	TD	TKP	VTK	
										1	2								3										

Construction Upgrades

APC	ET	PE

Door Options

CG	CG.TOP	DPSRR	MFO

¹ Not available on 12" and 24" (2 doors) wide

² Not available on 12" and 15" wide

³ Not available on 12" wide

**UTILITY with ROLL TRAYS,
84", 87", or 90" TALL, 24" DEEP**

12", 15", 18", 21", or 24"

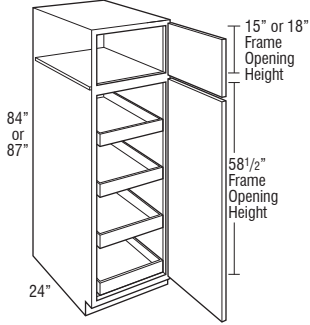

24", 27", 30", 33", or 36"

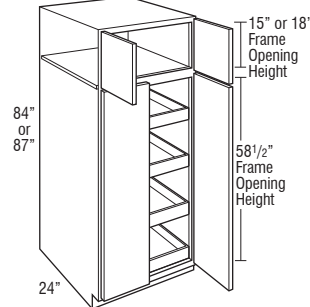

12", 15", 18", 21", or 24"

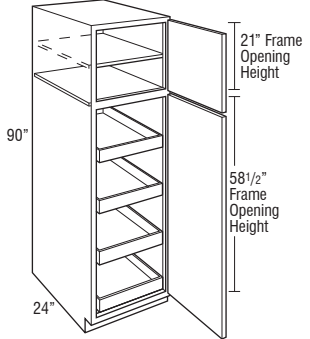

24", 27", 30", 33", or 36"

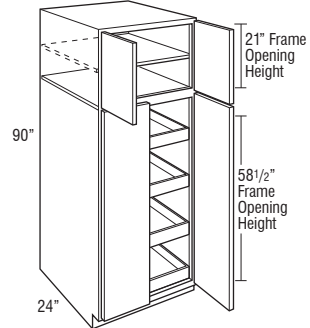

Price Point

	1	2	3	4	5	6	7	8	9	10	11	12
U128424RT L or R	2325	2541	2608	2675	2743	2809	2912	2982	3055	3126	3181	3355
U158424RT L or R	2376	2603	2672	2740	2810	2878	2988	3064	3138	3211	3269	3447
U188424RT L or R	2547	2781	2843	2905	2967	3028	3148	3226	3309	3390	3452	3644
U218424RT L or R	2688	2948	3017	3085	3154	3222	3351	3438	3528	3620	3686	3900
U248424RT L or R	2908	3183	3228	3271	3316	3360	3494	3587	3687	3780	3851	4081
U128724RT L or R	2372	2594	2659	2724	2789	2854	2959	3033	3106	3179	3235	3412
U158724RT L or R	2422	2655	2722	2790	2857	2924	3034	3111	3192	3267	3324	3508
U188724RT L or R	2597	2819	2883	2946	3010	3074	3192	3275	3358	3442	3504	3702
U218724RT L or R	2742	2987	3057	3128	3198	3269	3398	3489	3583	3673	3743	3959
U248724RT L or R	2955	3246	3285	3324	3363	3402	3541	3635	3738	3834	3905	4138

U248424RT	3126	3416	3436	3456	3476	3496	3638	3739	3844	3940	4018	4258
U278424RT	3256	3584	3634	3685	3735	3785	3948	4060	4177	4286	4373	4644
U308424RT	3387	3751	3834	3915	3997	4079	4257	4380	4511	4634	4728	5027
U338424RT	3558	3949	4036	4124	4211	4297	4490	4623	4763	4893	4998	5319
U368424RT	3724	4145	4238	4331	4424	4517	4723	4865	5013	5152	5265	5611
U248724RT	3165	3498	3508	3518	3528	3538	3682	3783	3892	3990	4068	4312
U278724RT	3303	3676	3716	3755	3794	3834	3997	4112	4231	4342	4429	4705
U308724RT	3439	3851	3922	3991	4061	4130	4311	4438	4570	4695	4791	5097
U338724RT	3613	4060	4134	4206	4280	4353	4549	4684	4826	4959	5064	5391
U368724RT	3785	4264	4342	4419	4497	4574	4786	4930	5080	5222	5338	5686

U129024RT L or R	2416	2617	2688	2758	2829	2898	3006	3081	3156	3232	3289	3471
U159024RT L or R	2470	2680	2753	2826	2898	2970	3080	3162	3243	3321	3379	3569
U189024RT L or R	2644	2854	2920	2986	3052	3117	3237	3319	3407	3491	3555	3760
U219024RT L or R	2796	3028	3101	3173	3246	3317	3447	3540	3634	3727	3798	4024
U249024RT L or R	3002	3304	3340	3375	3411	3447	3585	3686	3788	3883	3958	4194

U249024RT	3204	3454	3490	3524	3560	3595	3725	3828	3935	4038	4119	4367
U279024RT	3347	3766	3795	3823	3851	3879	4045	4162	4283	4397	4486	4765
U309024RT	3491	3956	4012	4068	4124	4180	4366	4494	4629	4755	4854	5164
U339024RT	3666	4170	4230	4289	4349	4408	4605	4742	4890	5025	5130	5464
U369024RT	3844	4381	4445	4508	4572	4634	4847	4990	5145	5295	5406	5763

Custom Modifications

ACS	ADDTK	AUTH	CBO	CCO	CFNTO	CFRMO	CH	CND	CW	DRT	DRWTK	DRWRM	EXBK	EX	FB	FFD	FPEB	FTK	FTK_V	ID	INFRM	MIP	RD	RECTK	RT	TD	TKP	VTK	
								1		2		3								4									

Construction Upgrades

APC	ET	PE

Door Options

CG	CG.TOP	DPSRR	MFO

¹ Minimum height is 78"
² Not available on 12" and 24" (2 doors) wide
³ Not available on 12" and 15" wide
⁴ Not available on 12" wide

**UTILITY with ROLL TRAYS,
93" or 96" TALL, 24" DEEP**

12", 15", 18", 21", or 24"

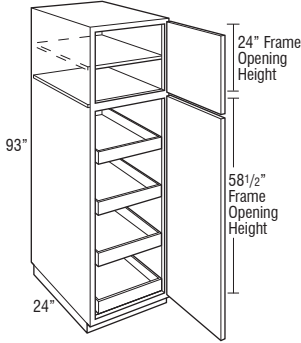

24", 27", 30", 33", or 36"

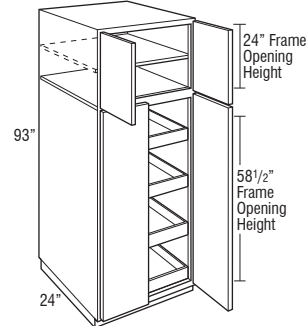

12", 15", 18", 21", or 24"

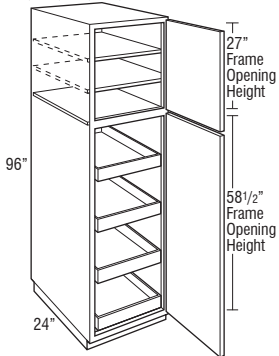

24", 27", 30", 33", or 36"

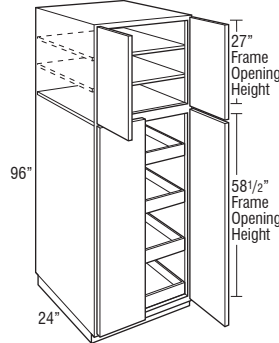

Price
Point

	1	2	3	4	5	6	7	8	9	10	11	12
U129324RT L or R	2503	2672	2750	2829	2907	2985	3100	3175	3256	3333	3394	3584
U159324RT L or R	2561	2737	2819	2899	2981	3062	3181	3259	3346	3427	3491	3687
U189324RT L or R	2739	2930	2998	3066	3135	3202	3327	3412	3506	3592	3659	3870
U219324RT L or R	2870	3110	3186	3261	3336	3411	3548	3644	3744	3839	3910	4146
U249324RT L or R	3093	3427	3454	3480	3506	3532	3677	3778	3883	3986	4061	4307

U249324RT	3347	3636	3641	3645	3650	3653	3807	3911	4024	4130	4212	4469
U279324RT	3552	3950	3954	3958	3962	3966	4139	4257	4383	4500	4593	4882
U309324RT	3699	4157	4187	4218	4248	4277	4467	4602	4741	4870	4974	5295
U339324RT	3891	4387	4418	4450	4481	4511	4715	4857	5007	5150	5258	5605
U369324RT	4082	4614	4647	4678	4710	4742	4962	5114	5274	5426	5542	5912

U129624RT L or R	2503	2672	2750	2829	2907	2985	3100	3175	3256	3333	3394	3584
U159624RT L or R	2561	2737	2819	2899	2981	3062	3181	3259	3346	3427	3491	3687
U189624RT L or R	2739	2930	2998	3066	3135	3202	3327	3412	3506	3592	3659	3870
U219624RT L or R	2870	3110	3186	3261	3336	3411	3548	3644	3744	3839	3910	4146
U249624RT L or R	3093	3427	3454	3480	3506	3532	3677	3778	3883	3986	4061	4307

U249624RT	3286	3502	3540	3578	3616	3653	3807	3911	4024	4130	4212	4469
U279624RT	3436	3551	3669	3785	3902	4018	4139	4257	4383	4500	4593	4882
U309624RT	3699	4157	4187	4218	4248	4277	4467	4602	4741	4870	4974	5295
U339624RT	3891	4387	4418	4450	4481	4511	4715	4857	5007	5150	5258	5605
U369624RT	4082	4614	4647	4678	4710	4742	4962	5114	5274	5426	5542	5912

Custom Modifications

ACS	ADTK	AUTH	CBO	CCO	CFNTO	CFRMO	CH	CND	CW	DRT	DRWTK	DRWWRM	EXBK	EX	FB	FFD	FPEB	FTK	FTK_V	ID	INVFRM	MIP	RD	RECTK_	RT	TD	TKP	VTK	

Construction Upgrades

APC	ET	PE

Door Options

CG	CG.TOP	DPSRR	MFO

¹ Not available on 12" and 24" (2 doors) wide
² Not available on 12" wide

**UTILITY ORGANIZER CABINET,
84", 87", 90", 93", or 96" TALL,
6" DEEP, 24" WIDE**

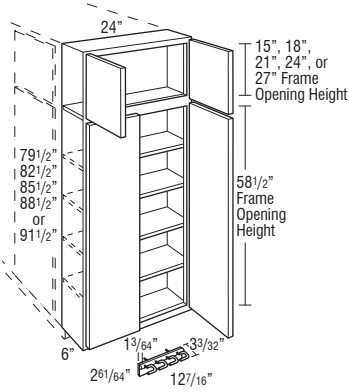

Price Point

	1	2	3	4	5	6	7	8	9	10	11	12
UOC24846	1590	1804	1892	1979	2066	2153	2280	2373	2467	2558	2628	2848
UOC24876	1634	1904	1978	2051	2125	2197	2327	2420	2518	2608	2680	2905
UOC24906	1673	2001	2061	2120	2180	2239	2376	2467	2568	2660	2732	2962
UOC24936	1784	2106	2159	2212	2265	2317	2457	2554	2654	2751	2826	3063
UOC24966	1784	2106	2159	2212	2265	2317	2457	2554	2654	2751	2826	3063

- Includes adjustable shelves and broom clip packaged separately (not installed):
84"-87" tall - four shelves
90"-93" tall - five shelves
96" tall - six shelves
- Designed to be installed onto an adjacent 24" deep tall cabinet.
- For proper installation, adjacent cabinet must have FPEB or 1/4" skin applied.
- 6" overlay fillers can be used on the side to add a decorative touch (Full overlay door styles only).
- Does not include toeboard or pedestal.
- Broom clip mounts to the cabinet back panel.
- Broom clip is also available as an accessory for field installation. See page 311.

Custom Modifications

ACS	ADDTK	AUTH	CBO	CCO	CFNTO	CFRMO	CH	CND	CW	DRT	DRWTK	DRWWRM	EXBK	EX	FB	FFD	FPEB	FTK	FTK_V	ID	INFRM	MIP	RD	RECTK_RT	TD	TKP	VTK
																		STD									

Construction Upgrades

APC	ET	PE

Door Options

CG	CG.TOP	DPSRR	MFO

¹ Minimum height is 73 1/2"

UTILITY ORGANIZER DROP ZONE CABINET, 84", 87", 90", 93", or 96" TALL, 9" DEEP, 24" WIDE

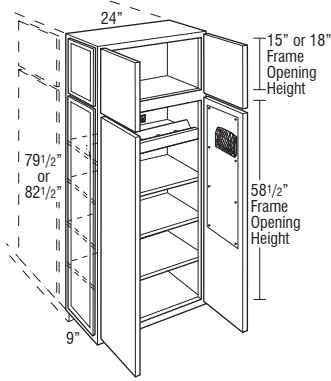
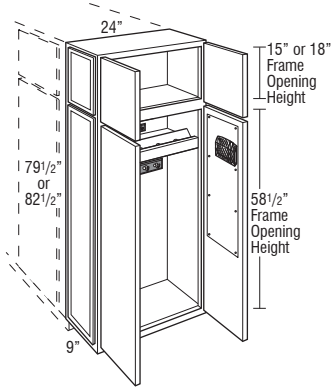

UOCDZ4849AEL/AER
UOCDZ4879AEL/AER

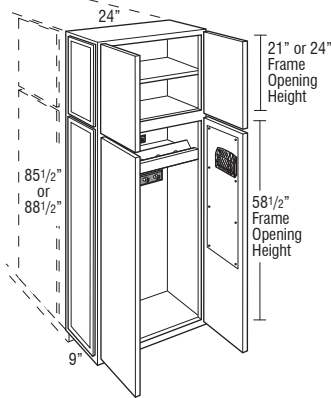

UOCDZ4909AEL/AER
UOCDZ4939AEL/AER

Price Point	1	2	3	4	5	6	7	8	9	10	11	12
UOCDZ24849AEL	2911	3125	3213	3300	3387	3474	3601	3694	3788	3879	3949	4169
UOCDZ24849AER	2911	3125	3213	3300	3387	3474	3601	3694	3788	3879	3949	4169
UOCDZ24879AEL	2955	3225	3299	3372	3446	3518	3648	3741	3839	3929	4001	4226
UOCDZ24879AER	2955	3225	3299	3372	3446	3518	3648	3741	3839	3929	4001	4226

UOCDZ24909AEL	2994	3322	3382	3441	3501	3560	3697	3788	3889	3981	4053	4283
UOCDZ24909AER	2994	3322	3382	3441	3501	3560	3697	3788	3889	3981	4053	4283
UOCDZ24939AEL	3105	3427	3480	3533	3586	3638	3778	3875	3975	4072	4147	4384
UOCDZ24939AER	3105	3427	3480	3533	3586	3638	3778	3875	3975	4072	4147	4384

UOCDZ24969AEL	3105	3427	3480	3533	3586	3638	3778	3875	3975	4072	4147	4384
UOCDZ24969AER	3105	3427	3480	3533	3586	3638	3778	3875	3975	4072	4147	4384

- Features magnetic whiteboards on back of lower doors, one magnetic black mesh pencil holder, charging station with power strip, black plastic grommet for power cord, key hooks, and coat hooks. Accessories are field installed.
- Charging station functions as an adjustable shelf, features five cord cut-out areas and includes a UL listed power strip with three standard 110-volt plug-ins and two USB charging ports.
- One adjustable shelf in upper section on 90" and 93", two adjustable shelves for 96", and three adjustable shelves in lower section.
- Authentic Ends are standard on one side. Specify AEL model for installation on the right side of a tall cabinet. Specify AER model for installation on the left side of a tall cabinet. Opposite end panel will feature FPEB construction (if decorative doors are desired on both sides of cabinet, order No Hinge Route doors for a Tall Pantry Pull-out).
- Designed to be installed onto an adjacent 24" deep tall cabinet.
- For proper installation, adjacent cabinet must have FPEB or 1/4" skin applied.
- Does not include toeboard or pedestal.
- Consult local electrical/building codes for proper installation.

Custom Modifications

ACS	ADDTK	AUTH	CBO	CCO	CFNTO	CFRMO	CH	CND	CW	DRT	DRWTK	DRWWRM	EXBK	EX	FB	FFD	FPEB	FTK	FTK_V	ID	INVFRM	MIP	RD	RECTK	RT	TD	TKP	VTK	

Construction Upgrades

APC	ET	PE

Door Options

CG	CG.TOP	DPSRR	MFO

¹ Minimum height is 73 1/2"

UOCDZ24909AEL/AER
UOCDZ24939AEL/AER

UOCDZ24969EL/AER

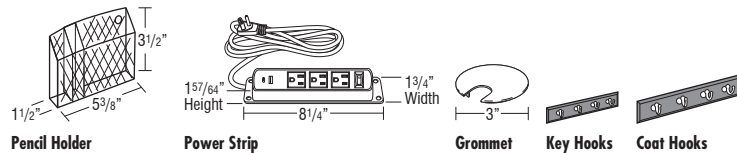

Pencil Holder

Power Strip

Grommet

Key Hooks

Coat Hooks

PANTRY TOP UNIT with SHELVES, SINGLE DOOR, 24" DEEP

15", 18", 21", or 24"

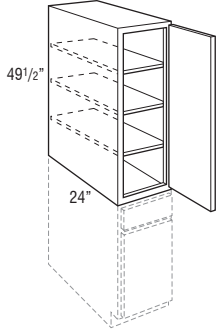

15", 18", 21", or 24"

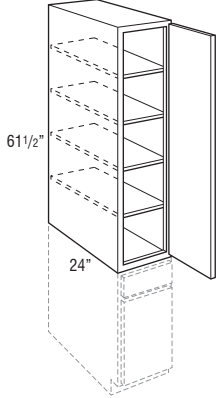

Price Point

	1	2	3	4	5	6	7	8	9	10	11	12
PTUS154924 L or R	1154	1333	1364	1395	1426	1456	1601	1691	1795	1901	1975	2159
PTUS184924 L or R	1296	1492	1500	1507	1513	1520	1675	1773	1882	1993	2071	2264
PTUS214924 L or R	1420	1631	1635	1639	1642	1645	1795	1894	2003	2110	2186	2388
PTUS244924 L or R	1481	1699	1701	1704	1706	1707	1858	1956	2062	2168	2246	2452

PTUS156124 L or R	1287	1482	1515	1549	1583	1616	1774	1875	1988	2101	2183	2385
PTUS186124 L or R	1418	1629	1659	1689	1719	1748	1907	2008	2124	2235	2319	2531
PTUS216124 L or R	1546	1772	1800	1827	1854	1881	2041	2144	2258	2369	2451	2674
PTUS246124 L or R	1610	1844	1871	1896	1923	1949	2108	2210	2326	2436	2519	2747

- Three adjustable shelves included with 49 1/2" high, and four adjustable shelves included with 61 1/2" high.
- Sets on any 15", 18", 21", or 24" wide base (B15 shown). No countertop is needed.
- Because of exposed seam when stacking, be sure to use an end panel skin to connect the seam on the side of the stacked cabinets. FPFB is not recommended.

Custom Modifications

ACS	ADDTK	AUTH	CBO	CCO	CFNTO	CFRMO	CH	CND	CW	DRT	DRWTK	DRWWRM	EXBK	EX	FB	FFD	FPFB	FTK	FTK_V	ID	INVFRM	MIP	RD	RECTK	RT	TD	TKP	VTK
		• ¹																										

Construction Upgrades

APC	ET	PE

Door Options

CG	CG.TOP	DPSRR	MFO

¹ RD12 is not compatible with AUTHL, AUTHR, or AUTHB
² Minimum height is 42"

PANTRY TOP UNIT with SHELVES, DOUBLE DOOR, 24" DEEP

24", 30", or 36"

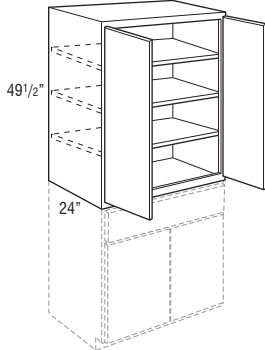

24", 30", or 36"

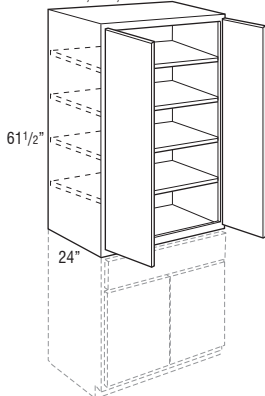

PTUS244924	1540	1765	1766	1767	1769	1770	1918	2016	2123	2227	2304	2516
PTUS304924	1745	1953	1970	1986	2002	2017	2162	2258	2362	2461	2537	2767
PTUS364924	1940	2145	2165	2185	2205	2226	2305	2410	2518	2623	2702	2945

PTUS246124	1639	1836	1881	1925	1970	2014	2174	2278	2392	2502	2585	2819
PTUS306124	1893	2116	2157	2198	2238	2278	2441	2547	2661	2772	2853	3108
PTUS366124	2093	2336	2354	2371	2388	2405	2571	2684	2805	2918	3006	3274

- Three adjustable shelves included with 49 1/2" high, and four adjustable shelves included with 61 1/2" high.
- Sets on any 24", 30", or 36" wide base (B30 shown). No countertop is needed.
- Because of exposed seam when stacking, be sure to use an end panel skin to connect the seam on the side of the stacked cabinets. FPFB is not recommended.

Custom Modifications

ACS	ADDTK	AUTH	CBO	CCO	CFNTO	CFRMO	CH	CND	CW	DRT	DRWTK	DRWWRM	EXBK	EX	FB	FFD	FPFB	FTK	FTK_V	ID	INVFRM	MIP	RD	RECTK	RT	TD	TKP	VTK
		• ¹																										

Construction Upgrades

APC	ET	PE

Door Options

CG	CG.TOP	DPSRR	MFO

¹ RD12 is not compatible with AUTHL, AUTHR, or AUTHB
² Minimum height is 42"
³ Not available on 24" wide

**PANTRY TOP UNIT,
SINGLE DOOR, 24" DEEP**

15", 18", 21", or 24"

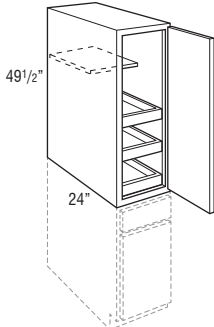

15", 18", 21", or 24"

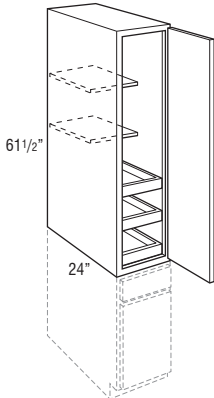

Price Point	1	2	3	4	5	6	7	8	9	10	11	12
PTU154924 L or R	1491	1670	1701	1732	1763	1793	1938	2028	2132	2238	2312	2496
PTU184924 L or R	1633	1829	1837	1844	1850	1857	2012	2110	2219	2330	2408	2601
PTU214924 L or R	1757	1968	1972	1976	1979	1982	2132	2231	2340	2447	2523	2725
PTU244924 L or R	1818	2036	2038	2041	2043	2044	2195	2293	2399	2505	2583	2789

PTU156124 L or R	1624	1819	1852	1886	1920	1953	2111	2212	2325	2438	2520	2722
PTU186124 L or R	1755	1966	1996	2026	2056	2085	2244	2345	2461	2572	2656	2868
PTU216124 L or R	1883	2109	2137	2164	2191	2218	2378	2481	2595	2706	2788	3011
PTU246124 L or R	1947	2181	2208	2233	2260	2286	2445	2547	2663	2773	2856	3084

- One 15" deep adjustable shelf included with 49 1/2" high, and two 15" deep adjustable shelves included with 61 1/2" high.
- Sets on any 15", 18", 21", or 24" wide base (B15 shown). No countertop is needed.
- Because of exposed seam when stacking, be sure to use an end panel skin to connect the seam on the side of the stacked cabinets. FPPEB is not recommended.

Custom Modifications

ACS	ADDTK	AUTH	CBO	CCO	CFNTO	CFRMO	CH	CND	CW	DRT	DRWTK	DRWWRM	EXBK	EX	FB	FD	FFD	FPPEB	FTK	FTK_V	ID	INVFRM	MIP	RD	RECTK	RT	TD	TKP	VTK
•	• ¹	•	•	•	•	•	•	•	•	•	•	•	•	•	•	•	•	•	•	•	•	•	•	•	•	•	•	•	•

Construction Upgrades

APC	ET	PE
•	•	•

Door Options

CG	CG.TOP	DPSRR	MFO
•	•	•	•

¹ RD12 is not compatible with AUTHL, AUTHR, or AUTHB

**PANTRY TOP UNIT,
DOUBLE DOOR, 24" DEEP**

24", 30", or 36"

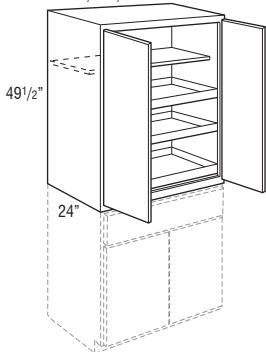

24", 30", or 36"

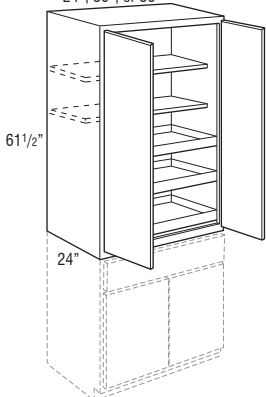

PTU244924	1877	2102	2103	2104	2106	2107	2255	2353	2460	2564	2641	2853
PTU304924	2082	2290	2307	2323	2339	2354	2499	2595	2699	2798	2874	3104
PTU364924	2277	2482	2502	2522	2542	2563	2642	2747	2855	2960	3039	3282

PTU246124	1976	2173	2218	2262	2307	2351	2511	2615	2729	2839	2922	3156
PTU306124	2230	2453	2494	2535	2575	2615	2778	2884	2998	3109	3190	3445
PTU366124	2430	2673	2691	2708	2725	2742	2908	3021	3142	3255	3343	3611

- One 15" deep adjustable shelf included with 49 1/2" high, and two 15" deep adjustable shelves included with 61 1/2" high.
- Sets on any 24", 30", or 36" wide base. (B30 shown.) No countertop is needed.
- Because of exposed seam when stacking, be sure to use an end panel skin to connect the seam on the side of the stacked cabinets. FPPEB is not recommended.

Custom Modifications

ACS	ADDTK	AUTH	CBO	CCO	CFNTO	CFRMO	CH	CND	CW	DRT	DRWTK	DRWWRM	EXBK	EX	FB	FD	FFD	FPPEB	FTK	FTK_V	ID	INVFRM	MIP	RD	RECTK	RT	TD	TKP	VTK
•	• ¹	•	•	•	•	•	•	•	•	•	•	•	•	•	•	•	•	•	•	•	•	•	•	•	•	•	•	•	•

Construction Upgrades

APC	ET	PE
•	•	•

Door Options

CG	CG.TOP	DPSRR	MFO
•	•	•	•

¹ RD12 is not compatible with AUTHL, AUTHR, or AUTHB

² Not available on 24" wide

TALL PANTRY PULL-OUT, 84", 87", or 90" TALL, 24" DEEP

9", 12", 15", or 18"

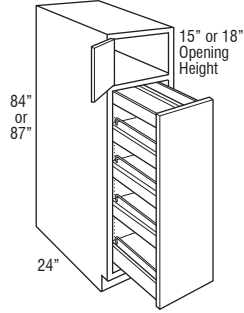

9", 12", 15", or 18"

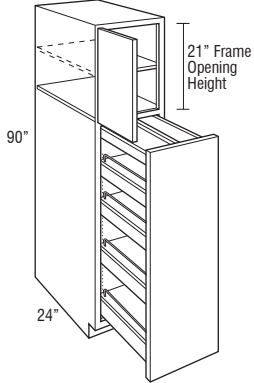

Price Point

	1	2	3	4	5	6	7	8	9	10	11	12
TPP98424 L or R	2357	2573	2640	2707	2775	2841	2944	3014	3087	3158	3213	3387
TPP128424 L or R	2510	2726	2793	2860	2928	2994	3097	3167	3240	3311	3366	3540
TPP158424 L or R	2641	2868	2937	3005	3075	3143	3253	3329	3403	3476	3534	3712
TPP188424 L or R	2812	3046	3108	3170	3232	3293	3413	3491	3574	3655	3717	3909
TPP98724 L or R	2404	2626	2691	2756	2821	2886	2991	3065	3138	3211	3267	3444
TPP128724 L or R	2557	2779	2844	2909	2974	3039	3144	3218	3291	3364	3420	3597
TPP158724 L or R	2687	2920	2987	3055	3122	3189	3299	3376	3457	3532	3589	3773
TPP188724 L or R	2862	3084	3148	3211	3275	3339	3457	3540	3623	3707	3769	3967

TPP99024 L or R	2448	2649	2720	2790	2861	2930	3038	3113	3188	3264	3321	3503
TPP129024 L or R	2601	2802	2873	2943	3014	3083	3191	3266	3341	3417	3474	3656
TPP159024 L or R	2735	2945	3018	3091	3163	3235	3345	3427	3508	3586	3644	3834
TPP189024 L or R	2909	3119	3185	3251	3317	3382	3502	3584	3672	3756	3820	4025

- Three adjustable shelves and one fixed bottom shelf with metallic finish wire rail sides. Natural finish wood pull-out shelves are 20 11/16" deep. Pull-out features top/bottom mounted soft-close full extension guides.
- For full access from both sides of unit, do not install against a wall or next to deeper appliances and cabinets.
- Pull-out mechanism not available for order for field installation, only available factory installed.

Custom Modifications

ACS	ADDTK	AUTH	CBO	CCO	CFNTO	CFRMO	CH	CND	CW	DRT	DRWTK	DRWWRM	EXBK	EX	FB	FFD	FPEB	FTK	FTK_V	ID	INFRM	MIP	RD	RECTK_RT	TD	TKP	VTK	

Construction Upgrades

APC	ET	PE

Door Options

CG	CG.TOP	DPSRR	MFO

¹ Minimum height is 78"

² Available only on 18" wide

³ Not available on 9" and 12" wide

TALL PANTRY PULL-OUT, 93" or 96" TALL, 24" DEEP

9", 12", 15", or 18"

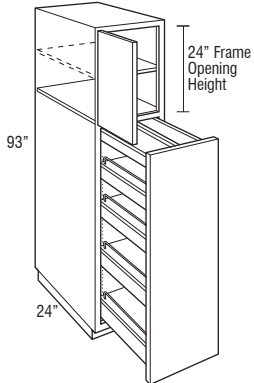

9", 12", 15", or 18"

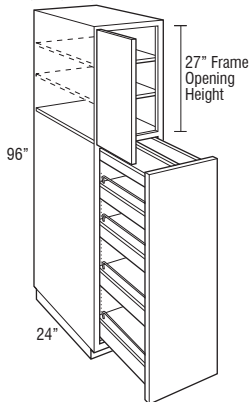

TPP99324 L or R	2535	2704	2782	2861	2939	3017	3132	3207	3288	3365	3426	3616
TPP129324 L or R	2688	2857	2935	3014	3092	3170	3285	3360	3441	3518	3579	3769
TPP159324 L or R	2826	3002	3084	3164	3246	3327	3446	3524	3611	3692	3756	3952
TPP189324 L or R	3004	3195	3263	3331	3400	3467	3592	3677	3771	3857	3924	4135

TPP99624 L or R	2535	2704	2782	2861	2939	3017	3132	3207	3288	3365	3426	3616
TPP129624 L or R	2688	2857	2935	3014	3092	3170	3285	3360	3441	3518	3579	3769
TPP159624 L or R	2826	3002	3084	3164	3246	3327	3446	3524	3611	3692	3756	3952
TPP189624 L or R	3004	3195	3263	3331	3400	3467	3592	3677	3771	3857	3924	4135

- Three adjustable shelves and one fixed bottom shelf with metallic finish wire rail sides. Natural finish wood pull-out shelves are 20 11/16" deep. Pull-out features top/bottom mounted soft-close full extension guides.
- For full access from both sides of unit, do not install against a wall or next to deeper appliances and cabinets.
- Pull-out mechanism not available for order for field installation, only available factory installed.

Custom Modifications

ACS	ADDTK	AUTH	CBO	CCO	CFNTO	CFRMO	CH	CND	CW	DRT	DRWTK	DRWWRM	EXBK	EX	FB	FFD	FPEB	FTK	FTK_V	ID	INFRM	MIP	RD	RECTK_RT	TD	TKP	VTK	

Construction Upgrades

APC	ET	PE

Door Options

CG	CG.TOP	DPSRR	MFO

¹ Not available on 9" and 12" wide

**PANTRY UNIT,
84", 87", or 90" TALL, 24" DEEP**

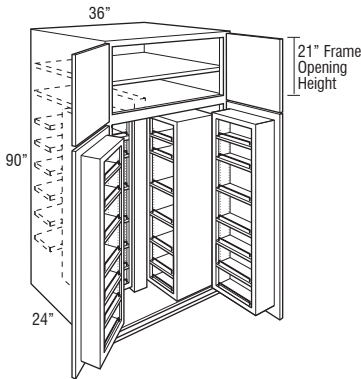
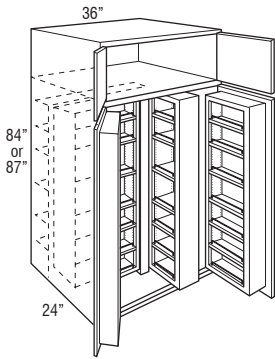

Price Point	1	2	3	4	5	6	7	8	9	10	11	12
PY368424	4276	4588	4729	4870	5011	5151	5456	5665	5886	6095	6256	6767
PY368724	4325	4655	4782	4909	5037	5163	5469	5680	5901	6111	6273	6784

PY369024	4377	4720	4834	4948	5062	5176	5480	5693	5915	6124	6285	6800
-----------------	------	------	------	------	------	------	------	------	------	------	------	------

- Shelves on swing-out units, mounting rails, and door racks have a furniture board core with natural finish wood fronts and metallic finish wire rails. Door mounted rack includes 6 adjustable shelves and one fixed shelf. Swing-outs include 4 adjustable shelves and 3 fixed shelves. Swing-out and door racks included but shipped separately for field installation, includes mounting screws and installation instructions. Adjustable shelves for use in back of cabinet are 4 1/2" deep, six included.
- Doors must be able to open 85° for interior swing-outs to function properly. A 3" filler is required if cabinet is located next to any full depth cabinet, refrigerator, or wall.

Custom Modifications

ACS	ADDTK	AUTH	CBO	CCO	CFNTO	CFRMO	CH	CND	CW	DRT	DRWTK	DRWWRM	EXBK	EX	FB	FFD	FPEB	FTK	FTK_V	ID	INVFRM	MIP	RD	RECTK_	RT	TD	TKP	VTK

Construction Upgrades

APC	ET	PE

Door Options

CG	CG.TOP	DPSRR	MFO

† Minimum height is 78"

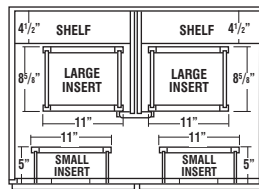

FRONT OF CABINET

Wood inserts for all styles:

- Top view of wood inserts positioning and size.
- Wood inserts are 56" high.

**PANTRY UNIT,
93" or 96" TALL, 24" DEEP**

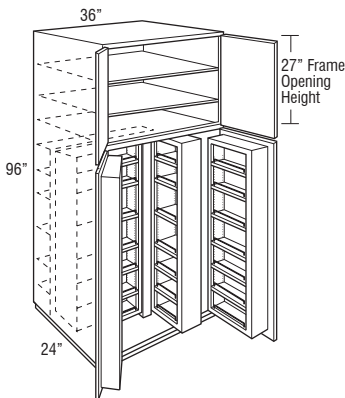
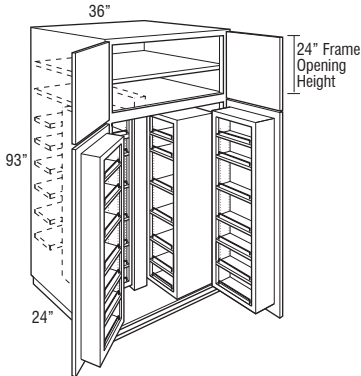

PY369324	4477	4798	4900	5001	5102	5202	5514	5724	5947	6156	6324	6839
-----------------	------	------	------	------	------	------	------	------	------	------	------	------

PY369624	4477	4798	4900	5001	5102	5202	5514	5724	5947	6156	6324	6839
-----------------	------	------	------	------	------	------	------	------	------	------	------	------

- Shelves on swing-out units, mounting rails, and door racks have a furniture board core with natural finish wood fronts and metallic finish wire rails. Door mounted rack includes 6 adjustable shelves and one fixed shelf. Swing-outs include 4 adjustable shelves and 3 fixed shelves. Swing-out and door racks included but shipped separately for field installation, includes mounting screws and installation instructions. Adjustable shelves for use in back of cabinet are 4 1/2" deep, six included.
- Doors must be able to open 85° for interior swing-outs to function properly. A 3" filler is required if cabinet is located next to any full depth cabinet, refrigerator, or wall.

Custom Modifications

ACS	ADDTK	AUTH	CBO	CCO	CFNTO	CFRMO	CH	CND	CW	DRT	DRWTK	DRWWRM	EXBK	EX	FB	FFD	FPEB	FTK	FTK_V	ID	INVFRM	MIP	RD	RECTK_	RT	TD	TKP	VTK

Construction Upgrades

APC	ET	PE

Door Options

CG	CG.TOP	DPSRR	MFO

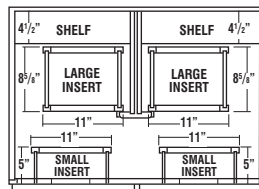

FRONT OF CABINET

Wood inserts for all styles:

- Top view of wood inserts positioning and size.
- Wood inserts are 56" high.

**PANTRY WALK-THROUGH,
84", 87", 90", 93", or 96" TALL,
24" DEEP**

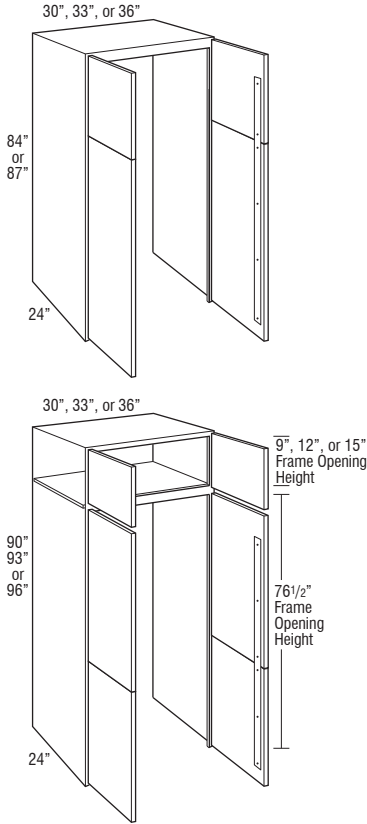

Price Point	1	2	3	4	5	6	7	8	9	10	11	12
PWT308424	2967	3331	3414	3495	3577	3659	3837	3960	4091	4214	4308	4607
PWT338424	3138	3529	3616	3704	3791	3877	4070	4203	4343	4473	4578	4899
PWT368424	3304	3725	3818	3911	4004	4097	4303	4445	4593	4732	4845	5191
PWT308724	3019	3431	3502	3571	3641	3710	3891	4018	4150	4275	4371	4677
PWT338724	3193	3640	3714	3786	3860	3933	4129	4264	4406	4539	4644	4971
PWT368724	3365	3844	3922	3999	4077	4154	4366	4510	4660	4802	4918	5266

PWT309024	3071	3536	3592	3648	3704	3760	3946	4074	4209	4335	4434	4744
PWT339024	3246	3750	3810	3869	3929	3988	4185	4322	4470	4605	4710	5044
PWT369024	3424	3961	4025	4088	4152	4214	4427	4570	4725	4875	4986	5343
PWT309324	3279	3737	3767	3798	3828	3857	4047	4182	4321	4450	4554	4875
PWT339324	3471	3967	3998	4030	4061	4091	4295	4437	4587	4730	4838	5185
PWT369324	3662	4194	4227	4258	4290	4322	4542	4694	4854	5006	5122	5492
PWT309624	3279	3737	3767	3798	3828	3857	4047	4182	4321	4450	4554	4875
PWT339624	3471	3967	3998	4030	4061	4091	4295	4437	4587	4730	4838	5185
PWT369624	3662	4194	4227	4258	4290	4322	4542	4694	4854	5006	5122	5492

- Cabinet does not have a bottom. 84" and 87" high do not have a back, 90"-96" high only have a back in the upper section. Doors are braced together, are 1/4" shorter than the cabinet for floor clearance, and use standard 107° soft-close hinges.
- Not available in certain door styles. See Door Style section for exceptions.
- Can be reduced in depth to 9" or increased in depth to 27".
- Authentic Ends uses the standard tall door configuration by height and will not align with the front doors. A tall end panel skin can be used to conceal door attachment screws on the interior of the cabinet end panel (see TEPS_ _WD on page 263).
- Height of ceiling needs to be considered for installation, 96" high cabinet requires 99" of height for 24" deep and 100" of height for 27" deep to stand unit upright.
- Cabinet will be shipped with additional attached supports to be removed during installation.
- ICMB (Inside Corner Moulding) can be used to conceal staples behind the face frame.
- SCRIBEB (Small Scribe Moulding) can be used to conceal exposed back edges of the end panels, which are not edgebanded.
- End panels will not be drilled for shelves.

	PO Door Height			FO Door Height			MFO Door Height		
	Top Door	Middle Door	Bottom Door	Top Door	Middle Door	Bottom Door	Top Door	Middle Door	Bottom Door
PWT308424	23 1/4"	N/A	59 1/2"	22 1/2"	N/A	61"	21 3/4"	N/A	61"
PWT338424	23 1/4"	N/A	59 1/2"	22 1/2"	N/A	61"	21 3/4"	N/A	61"
PWT368424	23 1/4"	N/A	59 1/2"	22 1/2"	N/A	61"	21 3/4"	N/A	61"
PWT308724	26 1/4"	N/A	59 1/2"	25 1/2"	N/A	61"	24 3/4"	N/A	61"
PWT338724	26 1/4"	N/A	59 1/2"	25 1/2"	N/A	61"	24 3/4"	N/A	61"
PWT368724	26 1/4"	N/A	59 1/2"	25 1/2"	N/A	61"	24 3/4"	N/A	61"
PWT309024	10"	43 1/2"	33 1/4"	11 1/2"	43 1/2"	34"	10 3/4"	43 1/2"	34"
PWT339024	10"	43 1/2"	33 1/4"	11 1/2"	43 1/2"	34"	10 3/4"	43 1/2"	34"
PWT369024	10"	43 1/2"	33 1/4"	11 1/2"	43 1/2"	34"	10 3/4"	43 1/2"	34"
PWT309324	13"	43 1/2"	33 1/4"	14 1/2"	43 1/2"	34"	13 3/4"	43 1/2"	34"
PWT339324	13"	43 1/2"	33 1/4"	14 1/2"	43 1/2"	34"	13 3/4"	43 1/2"	34"
PWT369324	13"	43 1/2"	33 1/4"	14 1/2"	43 1/2"	34"	13 3/4"	43 1/2"	34"
PWT309624	16"	43 1/2"	33 1/4"	17 1/2"	43 1/2"	34"	16 3/4"	43 1/2"	34"
PWT339624	16"	43 1/2"	33 1/4"	17 1/2"	43 1/2"	34"	16 3/4"	43 1/2"	34"
PWT369624	16"	43 1/2"	33 1/4"	17 1/2"	43 1/2"	34"	16 3/4"	43 1/2"	34"

Custom Modifications

ACS	ADDTK	AUTH	CBO	CCO	CFNTO	CFRMO	CH	CND	CW	DRT	DRWTK	DRWWRM	EXBK	EX	FFD	FPEB	FTK	FTK_V_ID	INFRM	MIP	RD	RECTK_	RT	TD	TKP	VTK
							1									STD										

Construction Upgrades

APC	ET	PE
STD		

Door Options

CG	CG.TOP	DPSRR	MFO
	3		

¹ Not available on 84", 87", and 90" high

² Not available on 30" wide

³ Available only on 90"-96" high

**SINGLE OVEN CABINET,
84", 87", or 90" TALL, 24" DEEP**

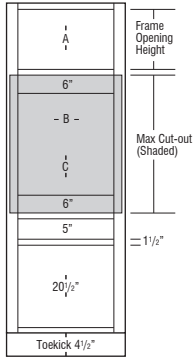
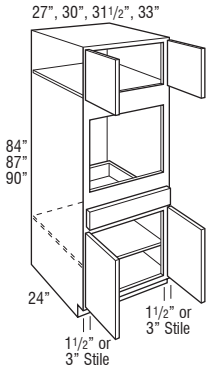

OSB _ _ _ 24

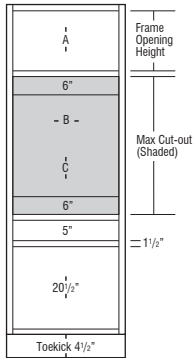

OSB _ _ _ 24N

Price Point

	1	2	3	4	5	6	7	8	9	10	11	12
OSB278424(N)	2256	2598	2629	2659	2689	2718	2871	2975	3087	3195	3273	3536
OSB308424(N)	2426	2717	2826	2933	3042	3149	3331	3451	3585	3705	3800	4107
OSB31.58424(N)	2644	2909	3033	3156	3279	3401	3597	3726	3872	4002	4104	4435
OSB338424(N)	2669	2989	3109	3228	3347	3465	3664	3796	3944	4076	4181	4518
OSB278724(N)	2541	2867	2901	2933	2966	2998	3167	3288	3410	3527	3614	3905
OSB308724(N)	2659	3135	3211	3286	3362	3437	3634	3771	3916	4045	4150	4487
OSB31.58724(N)	2872	3386	3468	3549	3631	3713	3926	4072	4229	4369	4481	4845
OSB338724(N)	2924	3448	3532	3615	3698	3781	3997	4148	4306	4450	4564	4936
OSB279024(N)	2824	3135	3171	3205	3241	3276	3465	3597	3731	3858	3955	4276
OSB309024(N)	2962	3390	3474	3558	3642	3725	3938	4087	4243	4386	4500	4869
OSB31.59024(N)	3200	3661	3752	3843	3933	4023	4253	4414	4582	4736	4860	5258
OSB339024(N)	3259	3730	3821	3913	4005	4097	4331	4495	4667	4825	4949	5355

- N represents Narrow Stile cabinets with 1 1/2" wide face frame side stiles and ACS modification availability (see page 13 for ACS specifications). Doors and drawer fronts have a consistent width reveal for full overlay (1/4") and partial overlay (1") and use standard soft-close hinges.
- On cabinets with 3" wide face frame side stiles, doors use face mount hinges. Doors and drawer fronts have a consistent width reveal for full overlay (1/4") and partial overlay (1").
- Cabinets with 3" wide face frames are not available in certain door styles. See Door Style section for exceptions.
- Base section will utilize a full depth shelf.
- Upper section on 90" tall has one full depth adjustable shelf.
- All top and bottom cross rails are 1 1/2" wide.
- Be sure to confirm a heat shield is built into your appliance by the manufacturer or install the heat shield included with your appliance. Heat shields are sold separately as an accessory.
- For built-in appliance support, OCINSTALLKIT is included in 24" deep oven cabinets (see page 313 for details). Oven install kit will not be included when depth is modified.
- OCINSTALLKIT weight limit is 400 lbs. per pair.
- Maximum cut-out dimension will allow 1/4" reveal for doors and drawer fronts on full overlay and 1" for partial overlay for trim kit face clearance.
- Oven cabinet cut-out is shaded in gray and is cut out on job site.

	A Frame Opening Height	B Cut-out Width (standard)			B Cut-out Width (with ACS modification)			C Cut-out Width		Door Height (Upper Section)	
		Min.	Min. (N)	Max.	Min.	Max.	Max. w/ Field Cut	Min.	Max.	Partial Overlay	Full Overlay
OSB278424(N)	15"	21"	24"	25 1/2"	21"	24"	25 1/2"	22 1/2"	31 1/2"	16"	17 1/2"
OSB308424(N)	15"	24"	27"	28 1/2"	24"	27"	28 1/2"	22 1/2"	31 1/2"	16"	17 1/2"
OSB31.58424(N)	15"	25 1/2"	28 1/2"	30"	25 1/2"	28 1/2"	30"	22 1/2"	31 1/2"	16"	17 1/2"
OSB338424(N)	15"	27"	30"	31 1/2"	27"	30"	31 1/2"	22 1/2"	31 1/2"	16"	17 1/2"
OSB278724(N)	18"	21"	24"	25 1/2"	21"	24"	25 1/2"	22 1/2"	31 1/2"	19"	20 1/2"
OSB308724(N)	18"	24"	27"	28 1/2"	24"	27"	28 1/2"	22 1/2"	31 1/2"	19"	20 1/2"
OSB31.58724(N)	18"	25 1/2"	28 1/2"	30"	25 1/2"	28 1/2"	30"	22 1/2"	31 1/2"	19"	20 1/2"
OSB338724(N)	18"	27"	30"	31 1/2"	27"	30"	31 1/2"	22 1/2"	31 1/2"	19"	20 1/2"
OSB279024(N)	21"	21"	24"	25 1/2"	21"	24"	25 1/2"	22 1/2"	31 1/2"	22"	23 1/2"
OSB309024(N)	21"	24"	27"	28 1/2"	24"	27"	28 1/2"	22 1/2"	31 1/2"	22"	23 1/2"
OSB31.59024(N)	21"	25 1/2"	28 1/2"	30"	25 1/2"	28 1/2"	30"	22 1/2"	31 1/2"	22"	23 1/2"
OSB339024(N)	21"	27"	30"	31 1/2"	27"	30"	31 1/2"	22 1/2"	31 1/2"	22"	23 1/2"

Custom Modifications

ACS	ADDTK	AUTH	CBO	CCO	CFNTO	CFRMO	CH	CND	CW	DRT	DRWTK	DRWWRM	EXBK	EX	FB	FFD	FPEB	FTK	FTK_V	ID	INVRM	MIP	RD	RECTK_	RT	TD	TKP	VTK
• ¹	•	•	•	•	•	•	•	•	•	•	•	•	•	•	•	•	•	•	•	•	•	•	•	•	•	•	•	•

Construction Upgrades

APC	ET	PE
•	•	•

Door Options

CG	CG.TOP	DPSRR	MFO
•	• ¹	•	•

¹ Only available on Narrow Stile (N) cabinets

² Not available on 27" wide

**SINGLE OVEN CABINET,
93" or 96" TALL, 24" DEEP**

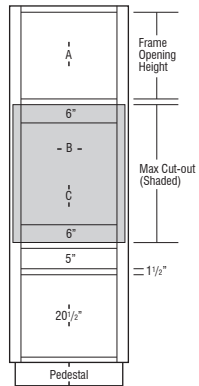
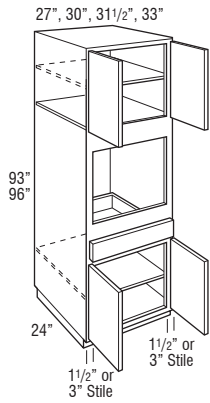

OSB _ _ _ 24

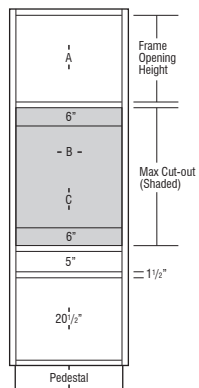

OSB _ _ _ 24N

Price Point

	1	2	3	4	5	6	7	8	9	10	11	12
OSB279324(N)	3389	3644	3693	3740	3787	3834	4057	4208	4367	4518	4637	5014
OSB309324(N)	3566	3909	4007	4105	4202	4300	4548	4721	4900	5072	5204	5628
OSB31.59324(N)	3852	4221	4328	4433	4538	4644	4912	5098	5292	5478	5620	6078
OSB339324(N)	3922	4300	4407	4515	4622	4729	5003	5193	5391	5580	5724	6191
OSB279624(N)	3389	3644	3693	3740	3787	3834	4057	4208	4367	4518	4637	5014
OSB309624(N)	3566	3909	4007	4105	4202	4300	4548	4721	4900	5072	5204	5628
OSB31.59624(N)	3852	4221	4328	4433	4538	4644	4912	5098	5292	5478	5620	6078
OSB339624(N)	3922	4300	4407	4515	4622	4729	5003	5193	5391	5580	5724	6191

- N represents Narrow Stile cabinets with 1 1/2" wide face frame side stiles and ACS modification availability (see page 13 for ACS specifications). Doors and drawer fronts have a consistent width reveal for full overlay (1/4") and partial overlay (1") and use standard soft-close hinges.
- On cabinets with 3" wide face frame side stiles, doors use face mount hinges. Doors and drawer fronts have a consistent width reveal for full overlay (1/4") and partial overlay (1").
- Cabinets with 3" wide face frames are not available in certain door styles. See Door Style section for exceptions.
- Base section will utilize a full depth shelf.
- Includes adjustable shelves in upper section:
93" tall - one shelf
96" tall - two shelves
- All top and bottom cross rails are 1 1/2" wide.
- Be sure to confirm a heat shield is built into your appliance by the manufacturer or install the heat shield included with your appliance. Heat shields are sold separately as an accessory.
- For built-in appliance support, OCINSTALLKIT is included in 24" deep oven cabinets (see page 313 for details). Oven install kit will not be included when depth is modified.
- OCINSTALLKIT weight limit is 400 lbs. per pair.
- Maximum cut-out dimension will allow 1/4" reveal for doors and drawer fronts on full overlay and 1" for partial overlay for trim kit face clearance.
- Oven cabinet cut-out is shaded in gray and is cut out on job site.

	A Frame Opening Height	B Cut-out Width (standard)			B Cut-out Width (with ACS modification)			C Cut-out Height		Door Height (Upper Section)	
		Min.	Min. (N)	Max.	Min.	Max.	Max. w/ Field Cut	Min.	Max.	Partial Overlay	Full Overlay
OSB279324(N)	24"	21"	24"	25 1/2"	21"	24"	25 1/2"	22 1/2"	31 1/2"	25"	26 1/2"
OSB309324(N)	24"	24"	27"	28 1/2"	24"	27"	28 1/2"	22 1/2"	31 1/2"	25"	26 1/2"
OSB31.59324(N)	24"	25 1/2"	28 1/2"	30"	25 1/2"	28 1/2"	30"	22 1/2"	31 1/2"	25"	26 1/2"
OSB339324(N)	24"	27"	30"	31 1/2"	27"	30"	31 1/2"	22 1/2"	31 1/2"	25"	26 1/2"
OSB279624(N)	27"	21"	24"	25 1/2"	21"	24"	25 1/2"	22 1/2"	31 1/2"	28"	29 1/2"
OSB309624(N)	27"	24"	27"	28 1/2"	24"	27"	28 1/2"	22 1/2"	31 1/2"	28"	29 1/2"
OSB31.59624(N)	27"	25 1/2"	28 1/2"	30"	25 1/2"	28 1/2"	30"	22 1/2"	31 1/2"	28"	29 1/2"
OSB339624(N)	27"	27"	30"	31 1/2"	27"	30"	31 1/2"	22 1/2"	31 1/2"	28"	29 1/2"

Custom Modifications

ACS	ADDTK	AUTH	CBO	CCO	CFNTO	CFRMO	CH	CND	CW	DRT	DRWTK	DRWWRM	EXBK	EX	FB	FFD	FPEB	FTK	FTK_V	ID	INVERM	MIP	RD	RECTK_	RT	TD	TKP	VTK
• ¹	•	•	•	•	•	•	•	•	•	•	•	•	•	•	•	•	•	•	•	•	•	•	•	•	•	•	•	•

Construction Upgrades

APC	ET	PE
•	•	•

Door Options

CG	CG.TOP	DPSRR	MFO
• ¹	•	•	•

¹ Only available on Narrow Stile (N) cabinets

² Not available on 27" wide

**SINGLE OVEN CABINET,
THREE DRAWER BASE,
84", 87", or 90" TALL, 24" DEEP**

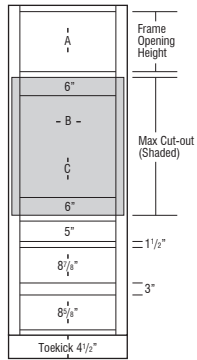
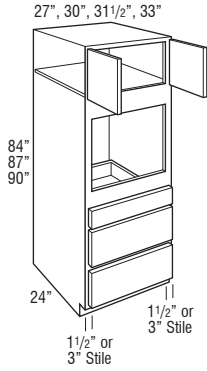

OS3D --- **24**

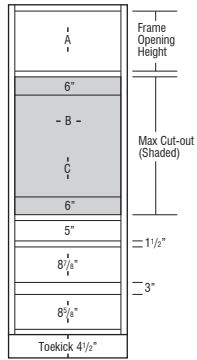

OS3D --- **24N**

Price Point

	1	2	3	4	5	6	7	8	9	10	11	12
OS3D278424(N)	2731	3073	3104	3134	3164	3193	3346	3450	3562	3670	3748	4011
OS3D308424(N)	2901	3192	3301	3408	3517	3624	3806	3926	4060	4180	4275	4582
OS3D31.58424(N)	3119	3384	3508	3631	3754	3876	4072	4201	4347	4477	4579	4910
OS3D338424(N)	3144	3464	3584	3703	3822	3940	4139	4271	4419	4551	4656	4993
OS3D278724(N)	3016	3342	3376	3408	3441	3473	3642	3763	3885	4002	4089	4380
OS3D308724(N)	3134	3610	3686	3761	3837	3912	4109	4246	4391	4520	4625	4962
OS3D31.58724(N)	3347	3861	3943	4024	4106	4188	4401	4547	4704	4844	4956	5320
OS3D338724(N)	3399	3923	4007	4090	4173	4256	4472	4623	4781	4925	5039	5411
OS3D279024(N)	3299	3610	3646	3680	3716	3751	3940	4072	4206	4333	4430	4751
OS3D309024(N)	3437	3865	3949	4033	4117	4200	4413	4562	4718	4861	4975	5344
OS3D31.59024(N)	3675	4136	4227	4318	4408	4498	4728	4889	5057	5211	5335	5733
OS3D339024(N)	3734	4205	4296	4388	4480	4572	4806	4970	5142	5300	5424	5830

- N represents Narrow Stile cabinets with 1 1/2" wide face frame side stiles and ACS modification availability (see page 13 for ACS specifications). Doors and drawer fronts have a consistent width reveal for full overlay (1/4") and partial overlay (1") and use standard soft-close hinges.
- On cabinets with 3" wide face frame side stiles, doors use face mount hinges. Doors and drawer fronts have a consistent width reveal for full overlay (1/4") and partial overlay (1").
- Cabinets with 3" wide face frames are not available in certain door styles. See Door Style section for exceptions.
- Upper section on 90" tall has one full depth adjustable shelf.
- All top and bottom cross rails are 1 1/2" wide.
- Be sure to confirm a heat shield is built into your appliance by the manufacturer or install the heat shield included with your appliance. Heat shields are sold separately as an accessory.
- Exterior height of bottom 2 drawer boxes is 6 3/8".
- For built-in appliance support, OCINSTALLKIT is included in 24" deep oven cabinets (see page 313 for details). Oven install kit will not be included when depth is modified.
- OCINSTALLKIT weight limit is 400 lbs. per pair.
- Maximum cut-out dimension will allow 1/4" reveal for doors and drawer fronts on full overlay and 1" for partial overlay for trim kit face clearance.
- Oven cabinet cut-out is shaded in gray and is cut out on job site.

	A Frame Opening Height	B Cut-out Width (standard)			B Cut-out Width (with ACS modification)			C Cut-out Height		Door Height (Upper Section)	
		Min.	Min. (N)	Max.	Min.	Max.	Max. w/ Field Cut	Min.	Max.	Partial Overlay	Full Overlay
OS3D278424(N)	15"	21"	24"	25 1/2"	21"	24"	25 1/2"	22 1/2"	31 1/2"	16"	17 1/2"
OS3D308424(N)	15"	24"	27"	28 1/2"	24"	27"	28 1/2"	22 1/2"	31 1/2"	16"	17 1/2"
OS3D31.58424(N)	15"	25 1/2"	28 1/2"	30"	25 1/2"	28 1/2"	30"	22 1/2"	31 1/2"	16"	17 1/2"
OS3D338424(N)	15"	27"	30"	31 1/2"	27"	30"	31 1/2"	22 1/2"	31 1/2"	16"	17 1/2"
OS3D278724(N)	18"	21"	24"	25 1/2"	21"	24"	25 1/2"	22 1/2"	31 1/2"	19"	20 1/2"
OS3D308724(N)	18"	24"	27"	28 1/2"	24"	27"	28 1/2"	22 1/2"	31 1/2"	19"	20 1/2"
OS3D31.58724(N)	18"	25 1/2"	28 1/2"	30"	25 1/2"	28 1/2"	30"	22 1/2"	31 1/2"	19"	20 1/2"
OS3D338724(N)	18"	27"	30"	31 1/2"	27"	30"	31 1/2"	22 1/2"	31 1/2"	19"	20 1/2"
OS3D279024(N)	21"	21"	24"	25 1/2"	21"	24"	25 1/2"	22 1/2"	31 1/2"	22"	23 1/2"
OS3D309024(N)	21"	24"	27"	28 1/2"	24"	27"	28 1/2"	22 1/2"	31 1/2"	22"	23 1/2"
OS3D31.59024(N)	21"	25 1/2"	28 1/2"	30"	25 1/2"	28 1/2"	30"	22 1/2"	31 1/2"	22"	23 1/2"
OS3D339024(N)	21"	27"	30"	31 1/2"	27"	30"	31 1/2"	22 1/2"	31 1/2"	22"	23 1/2"

Custom Modifications

ACS	ADDTK	AUTH	CBO	CCO	CFNTD	CFRMO	CH	CND	CW	DRT	DRWTK	DRWWRM	EXBK	EX	FB	FFD	FPEB	FTK	FTK_V	ID	INVRM	MIP	RD	RECTK_	RT	TD	TKP	VTK
• ¹	•	•	•	•	•	•	•	•	•	•	•	•	•	•	•	•	•	•	•	•	•	•	•	•	•	•	•	•

Construction Upgrades

APC	ET	PE
•	•	•

Door Options

CG	CG.TOP	DPSRR	MFO
• ¹	•	•	•

¹ Only available on Narrow Stile (N) cabinets

² Not available on 27" wide

**SINGLE OVEN CABINET,
THREE DRAWER BASE,
93" or 96" TALL, 24" DEEP**

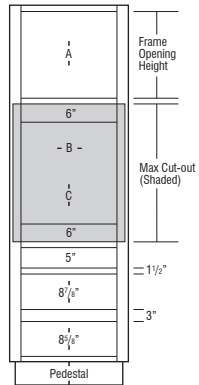
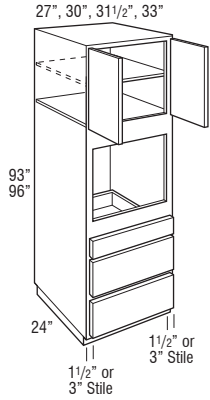

OS3D ___ 24

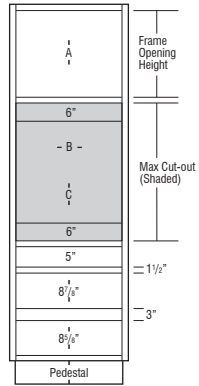

OS3D ___ 24N

Price Point

	1	2	3	4	5	6	7	8	9	10	11	12
OS3D279324(N)	3864	4119	4168	4215	4262	4309	4532	4683	4842	4993	5112	5489
OS3D309324(N)	4041	4384	4482	4580	4677	4775	5023	5196	5375	5547	5679	6103
OS3D31.59324(N)	4327	4696	4803	4908	5013	5119	5387	5573	5767	5953	6095	6553
OS3D339324(N)	4397	4775	4882	4990	5097	5204	5478	5668	5866	6055	6199	6666
OS3D279624(N)	3864	4119	4168	4215	4262	4309	4532	4683	4842	4993	5112	5489
OS3D309624(N)	4041	4384	4482	4580	4677	4775	5023	5196	5375	5547	5679	6103
OS3D31.59624(N)	4327	4696	4803	4908	5013	5119	5387	5573	5767	5953	6095	6553
OS3D339624(N)	4397	4775	4882	4990	5097	5204	5478	5668	5866	6055	6199	6666

- N represents Narrow Stile cabinets with 1 1/2" wide face frame side stiles and ACS modification availability (see page 13 for ACS specifications). Doors and drawer fronts have a consistent width reveal for full overlay (1/4") and partial overlay (1") and use standard soft-close hinges.
- On cabinets with 3" wide face frame side stiles, doors use face mount hinges. Doors and drawer fronts have a consistent width reveal for full overlay (1/4") and partial overlay (1").
- Cabinets with 3" wide face frames are not available in certain door styles. See Door Style section for exceptions.
- Includes adjustable shelves in upper section:
93" tall - one shelf
96" tall - two shelves
- All top and bottom cross rails are 1 1/2" wide.
- Be sure to confirm a heat shield is built into your appliance by the manufacturer or install the heat shield included with your appliance. Heat shields are sold separately as an accessory.
- Exterior height of bottom 2 drawer boxes is 6 3/8".
- For built-in appliance support, OCINSTALLKIT is included in 24" deep oven cabinets (see page 313 for details). Oven install kit will not be included when depth is modified.
- OCINSTALLKIT weight limit is 400 lbs. per pair.
- Maximum cut-out dimension will allow 1/4" reveal for doors and drawer fronts on full overlay and 1" for partial overlay for trim kit face clearance.
- Oven cabinet cut-out is shaded in gray and is cut out on job site.

	A Frame Opening Height	B Cut-out Width (standard)			B Cut-out Width (with ACS modification)			C Cut-out Height		Door Height (Upper Section)	
		Min.	Min. (N)	Max.	Min.	Max.	Max. w/ Field Cut	Min.	Max.	Partial Overlay	Full Overlay
OS3D279324(N)	24"	21"	24"	25 1/2"	21"	24"	25 1/2"	22 1/2"	31 1/2"	25"	26 1/2"
OS3D309324(N)	24"	24"	27"	28 1/2"	24"	27"	28 1/2"	22 1/2"	31 1/2"	25"	26 1/2"
OS3D31.59324(N)	24"	25 1/2"	28 1/2"	30"	25 1/2"	28 1/2"	30"	22 1/2"	31 1/2"	25"	26 1/2"
OS3D339324(N)	24"	27"	30"	31 1/2"	27"	30"	31 1/2"	22 1/2"	31 1/2"	25"	26 1/2"
OS3D279624(N)	27"	21"	24"	25 1/2"	21"	24"	25 1/2"	22 1/2"	31 1/2"	28"	29 1/2"
OS3D309624(N)	27"	24"	27"	28 1/2"	24"	27"	28 1/2"	22 1/2"	31 1/2"	28"	29 1/2"
OS3D31.59624(N)	27"	25 1/2"	28 1/2"	30"	25 1/2"	28 1/2"	30"	22 1/2"	31 1/2"	28"	29 1/2"
OS3D339624(N)	27"	27"	30"	31 1/2"	27"	30"	31 1/2"	22 1/2"	31 1/2"	28"	29 1/2"

Custom Modifications

ACS	ADDTK	AUTH	CBO	CCO	CFNTO	CFRMO	CH	CND	CW	DRT	DRWTK	DRWWRM	EXBK	EX	FB	FFD	FPEB	FTK	FTK_V	ID	INVERM	MIP	RD	RECTK_	RT	TD	TKP	VTK	
• ¹											• ²																		

Construction Upgrades

APC	ET	PE
•		•

Door Options

CG	CG.TOP	DPSRR	MFO
• ¹		•	•

¹ Only available on Narrow Stile (N) cabinets
² Not available on 27" wide

**OVEN MICROWAVE COMBO
CABINET, DEEP DRAWER,
84", 87", or 90" TALL, 24" DEEP**

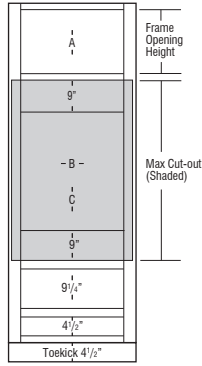
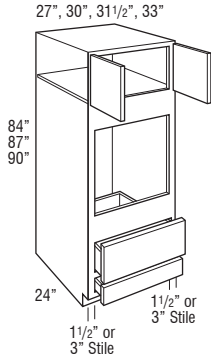

OCS_...24DD

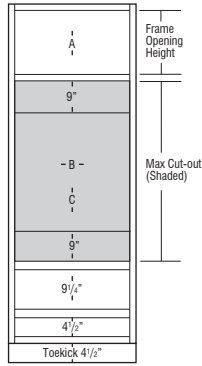

OCS_...24DDN

Price Point

	1	2	3	4	5	6	7	8	9	10	11	12
OCS278424DD(N)	2718	2990	3021	3051	3081	3110	3265	3372	3487	3585	3668	3937
OCS308424DD(N)	2951	3247	3343	3440	3536	3631	3816	3941	4071	4189	4283	4598
OCS31.58424DD(N)	3211	3532	3609	3684	3759	3834	4024	4157	4294	4417	4517	4844
OCS338424DD(N)	3471	3818	3873	3927	3982	4035	4232	4374	4516	4646	4751	5090
OCS278724DD(N)	2964	3260	3293	3325	3358	3390	3560	3683	3809	3919	4010	4308
OCS308724DD(N)	3210	3531	3629	3725	3823	3919	4117	4258	4402	4528	4631	4975
OCS31.58724DD(N)	3389	3758	3854	3950	4047	4143	4352	4500	4651	4784	4894	5254
OCS338724DD(N)	3567	3983	4079	4174	4271	4366	4586	4741	4900	5039	5158	5533
OCS279024DD(N)	3192	3520	3557	3594	3631	3668	3857	3991	4128	4249	4351	4677
OCS309024DD(N)	3425	3853	3940	4028	4115	4202	4418	4571	4729	4870	4982	5351
OCS31.59024DD(N)	3656	4068	4163	4259	4355	4450	4678	4838	5005	5151	5273	5660
OCS339024DD(N)	3885	4282	4386	4490	4594	4697	4938	5106	5281	5431	5563	5970

- N represents Narrow Stile cabinets with 1 1/2" wide face frame side stiles and ACS modification availability (see page 13 for ACS specifications). Doors and drawer fronts have a consistent width reveal for full overlay (1/4") and partial overlay (1") and use standard soft-close hinges.
- On cabinets with 3" wide face frame side stiles, doors use face mount hinges. Doors and drawer fronts have a consistent width reveal for full overlay (1/4") and partial overlay (1").
- Cabinets with 3" wide face frames are not available in certain door styles. See Door Style section for exceptions.
- Upper section on 90" tall has one full depth adjustable shelf.
- All top and bottom cross rails are 1 1/2" wide.
- Be sure to confirm a heat shield is built into your appliance by the manufacturer or install the heat shield included with your appliance. Heat shields are sold separately as an accessory.
- For built-in appliance support, OCINSTALLKIT is included in 24" deep oven cabinets (see page 313 for details). Oven install kit will not be included when depth is modified.
- OCINSTALLKIT weight limit is 400 lbs. per pair.
- Oven cabinets feature an open back in cut-out area designed to improve field appliance installation.
- Maximum cut-out dimension will allow 1/4" reveal for doors and drawer fronts on full overlay and 1" for partial overlay for trim kit face clearance.

	A Frame Opening Height	B Cut-out Width (standard)			B Cut-out Width (with ACS modification)			C Cut-out Height		Door Height (Upper Section)	
		Min.	Min. (N)	Max.	Min.	Max.	Max. w/ Field Cut	Min.	Max.	Partial Overlay	Full Overlay
OCS278424DD(N)	15"	21"	24"	25 1/2"	21"	24"	25 1/2"	27 3/4"	42 3/4"	16"	17 1/2"
OCS308424DD(N)	15"	24"	27"	28 1/2"	24"	27"	28 1/2"	27 3/4"	42 3/4"	16"	17 1/2"
OCS31.58424DD(N)	15"	25 1/2"	28 1/2"	30"	25 1/2"	28 1/2"	30"	27 3/4"	42 3/4"	16"	17 1/2"
OCS338424DD(N)	15"	27"	30"	31 1/2"	27"	30"	31 1/2"	27 3/4"	42 3/4"	16"	17 1/2"
OCS278724DD(N)	18"	21"	24"	25 1/2"	21"	24"	25 1/2"	27 3/4"	42 3/4"	19"	20 1/2"
OCS308724DD(N)	18"	24"	27"	28 1/2"	24"	27"	28 1/2"	27 3/4"	42 3/4"	19"	20 1/2"
OCS31.58724DD(N)	18"	25 1/2"	28 1/2"	30"	25 1/2"	28 1/2"	30"	27 3/4"	42 3/4"	19"	20 1/2"
OCS338724DD(N)	18"	27"	30"	31 1/2"	27"	30"	31 1/2"	27 3/4"	42 3/4"	19"	20 1/2"
OCS279024DD(N)	21"	21"	24"	25 1/2"	21"	24"	25 1/2"	27 3/4"	42 3/4"	22"	23 1/2"
OCS309024DD(N)	21"	24"	27"	28 1/2"	24"	27"	28 1/2"	27 3/4"	42 3/4"	22"	23 1/2"
OCS31.59024DD(N)	21"	25 1/2"	28 1/2"	30"	25 1/2"	28 1/2"	30"	27 3/4"	42 3/4"	22"	23 1/2"
OCS339024DD(N)	21"	27"	30"	31 1/2"	27"	30"	31 1/2"	27 3/4"	42 3/4"	22"	23 1/2"

Custom Modifications

ACS	ADDTK	AUTH	CBO	CCO	CFNTO	CFRMO	CH	CND	CW	DRT	DRWTK	DRWWRM	EXBK	EX	FB	FFD	FPEB	FTK	FTK_V	ID	INFRM	MIP	RD	RECTK_	RT	TD	TKP	VTK
• ¹	•	•	•	•	•	•	•	•	•	•	•	•	•	•	•	•	•	•	•	•	•	•	•	•	•	•	•	•

Construction Upgrades

APC	ET	PE
•	•	•

Door Options

CG	CG.TOP	DPSRR	MFO
•	•	•	•

¹ Only available on Narrow Stile (N) cabinets
² Not available on 27" wide

OVEN MICROWAVE COMBO CABINET, DEEP DRAWER, 93" or 96" TALL, 24" DEEP

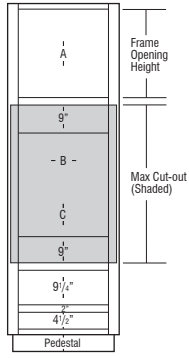
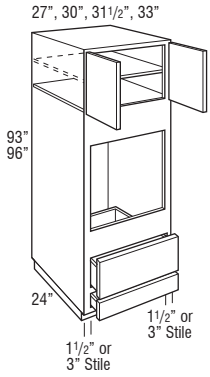

OCS _ _ _ 24DD

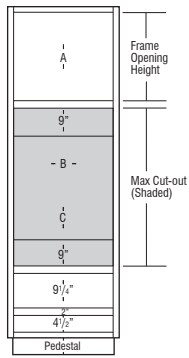

OCS _ _ _ 24DDN

Price Point

	1	2	3	4	5	6	7	8	9	10	11	12
OCS279324DD(N)	3755	4012	4066	4118	4172	4225	4443	4601	4760	4910	5028	5410
OCS309324DD(N)	4029	4369	4472	4575	4678	4780	5029	5206	5389	5553	5686	6115
OCS31.59324DD(N)	4275	4624	4738	4850	4962	5072	5337	5525	5719	5890	6032	6485
OCS339324DD(N)	4520	4880	5002	5123	5244	5365	5645	5844	6047	6227	6378	6854
OCS279624DD(N)	3755	4012	4066	4118	4172	4225	4443	4601	4760	4910	5028	5410
OCS309624DD(N)	4029	4369	4472	4575	4678	4780	5029	5206	5389	5553	5686	6115
OCS31.59624DD(N)	4275	4624	4738	4850	4962	5072	5337	5525	5719	5890	6032	6485
OCS339624DD(N)	4520	4880	5002	5123	5244	5365	5645	5844	6047	6227	6378	6854

- N represents Narrow Stile cabinets with 1 1/2" wide face frame side stiles and ACS modification availability (see page 13 for ACS specifications). Doors and drawer fronts have a consistent width reveal for full overlay (1/4") and partial overlay (1") and use standard soft-close hinges.
- On cabinets with 3" wide face frame side stiles, doors use face mount hinges. Doors and drawer fronts have a consistent width reveal for full overlay (1/4") and partial overlay (1").
- Cabinets with 3" wide face frames are not available in certain door styles. See Door Style section for exceptions.
- Includes adjustable shelves in upper section:
93" tall - one shelf
96" tall - two shelves
- All top and bottom cross rails are 1 1/2" wide.
- Be sure to confirm a heat shield is built into your appliance by the manufacturer or install the heat shield included with your appliance. Heat shields are sold separately as an accessory.
- For built-in appliance support, OCINSTALLKIT is included in 24" deep oven cabinets (see page 313 for details). Oven install kit will not be included when depth is modified.
- OCINSTALLKIT weight limit is 400 lbs. per pair.
- Oven cabinets feature an open back in cut-out area designed to improve field appliance installation.
- Maximum cut-out dimension will allow 1/4" reveal for doors and drawer fronts on full overlay and 1" for partial overlay for trim kit face clearance.

	A Frame Opening Height	B Cut-out Width (standard)			B Cut-out Width (with ACS modification)			C Cut-out Height		Door Height (Upper Section)	
		Min.	Min. (N)	Max.	Min.	Max.	Max. w/ Field Cut	Min.	Max.	Partial Overlay	Full Overlay
OCS279324DD(N)	24"	21"	24"	25 1/2"	21"	24"	25 1/2"	27 3/4"	42 3/4"	25"	26 1/2"
OCS309324DD(N)	24"	24"	27"	28 1/2"	24"	27"	28 1/2"	27 3/4"	42 3/4"	25"	26 1/2"
OCS31.59324DD(N)	24"	25 1/2"	28 1/2"	30"	25 1/2"	28 1/2"	30"	27 3/4"	42 3/4"	25"	26 1/2"
OCS339324DD(N)	24"	27"	30"	31 1/2"	27"	30"	31 1/2"	27 3/4"	42 3/4"	25"	26 1/2"
OCS279624DD(N)	27"	21"	24"	25 1/2"	21"	24"	25 1/2"	27 3/4"	42 3/4"	28"	29 1/2"
OCS309624DD(N)	27"	24"	27"	28 1/2"	24"	27"	28 1/2"	27 3/4"	42 3/4"	28"	29 1/2"
OCS31.59624DD(N)	27"	25 1/2"	28 1/2"	30"	25 1/2"	28 1/2"	30"	27 3/4"	42 3/4"	28"	29 1/2"
OCS339624DD(N)	27"	27"	30"	31 1/2"	27"	30"	31 1/2"	27 3/4"	42 3/4"	28"	29 1/2"

Custom Modifications

ACS	ADDTK	AUTH	CBO	CCO	CFNTO	CFRMO	CH	CND	CW	DRT	DRWTK	DRWWRM	EXBK	EX	FB	FFD	FPEB	FTK	FTK_V	ID	INFRM	MIP	RD	RECTK_	RT	TD	TKP	VTK
• ¹	•	•	•	•	•	•	•	•	•	•	•	•	•	•	•	•	•	•	•	•	•	•	•	•	•	•	•	•

Construction Upgrades

APC	ET	PE
•	•	•

Door Options

CG	CG.TOP	DPSRR	MFO
• ¹	•	•	•

¹ Only available on Narrow Stile (N) cabinets

² Not available on 27" wide

DOUBLE OVEN CABINET, 66" TALL, 24" DEEP

27", 30", 31 1/2", 33"

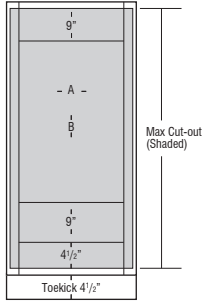
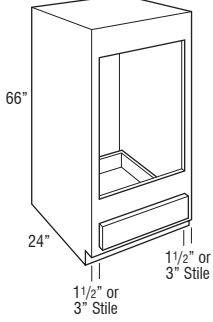

OCD_6624

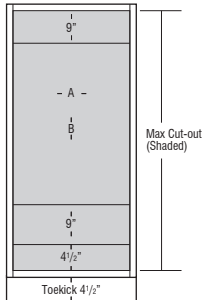

OCD_6624N

Price Point

	1	2	3	4	5	6	7	8	9	10	11	12
OCD276624(N)	1458	1604	1628	1652	1676	1700	1796	1862	1931	1996	2044	2209
OCD306624(N)	1533	1687	1757	1826	1896	1965	2078	2157	2238	2312	2372	2563
OCD31.56624(N)	1654	1819	1878	1936	1995	2052	2171	2253	2337	2415	2478	2679
OCD336624(N)	1773	1950	1998	2045	2093	2140	2263	2348	2435	2519	2583	2794

- N represents Narrow Stile cabinets with 1 1/2" wide face frame side stiles and ACS modification availability (see page 13 for ACS specifications). Drawer front has a consistent width reveal for full overlay (1/4") and partial overlay (1").
- Cabinets with 3" wide face frames are not available in certain door styles. See Door Style section for exceptions.
- All top and bottom cross rails are 1 1/2" wide.
- Be sure to confirm a heat shield is built into your appliance by the manufacturer or install the heat shield included with your appliance. Heat shields are sold separately as an accessory.
- For built-in appliance support, OCINSTALLKIT is included in 24" deep oven cabinets (see page 313 for details). Oven install kit will not be included when depth is modified.
- OCINSTALLKIT weight limit is 400 lbs. per pair.
- Maximum w/Drawer cut-out dimension will allow 1/4" reveal for drawer fronts on full overlay and 1" for partial overlay for trim kit face clearance.
- Oven cabinet cut-out is shaded in gray and is cut out on job site.
- If the maximum height (as shown in gray) is cut out, the drawer will no longer be included. See chart below for maximum cut-out allowed if you want to keep the drawer.

	A Cut-out Width (standard)			A Cut-out Width (with ACS modification)			B Cut-out Height		
	Min.	Min. (N)	Max.	Min.	Max.	Max. w/ Field Cut	Min.	Max. Keeps Bottom Drawer	Max. Replaces Bottom Drawer
OCD276624(N)	21"	24"	25 1/2"	21"	24"	25 1/2"	37 1/2"	52 1/2"	58 1/2"
OCD306624(N)	24"	27"	28 1/2"	24"	27"	28 1/2"	37 1/2"	52 1/2"	58 1/2"
OCD31.56624(N)	25 1/2"	28 1/2"	30"	25 1/2"	28 1/2"	30"	37 1/2"	52 1/2"	58 1/2"
OCD336624(N)	27"	30"	31 1/2"	27"	30"	31 1/2"	37 1/2"	52 1/2"	58 1/2"

Custom Modifications

ACS	ADDTK	AUTH	CBO	CCO	CFNTO	CFRMO	CH	CND	CW	DRT	DRWTK	DRWWRM	EXBK	EX	FB	FFD	FPEB	FTK	FTK_V	ID	INVERM	MIP	RD	RECTK	RT	TD	TKP	VTK	
• ¹											• ²																		

Construction Upgrades

APC	ET	PE
•		•

Door Options

CG	CG.TOP	DPSRR	MFO

¹ Only available on Narrow Stile (N) cabinets
² Not available on 27" wide

DOUBLE OVEN CABINET, 84", 87", or 90" TALL, 24" DEEP

27", 30", 31 1/2", 33"

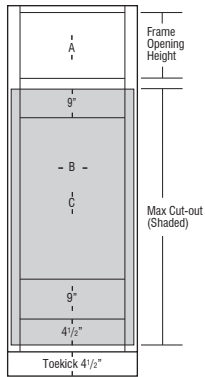
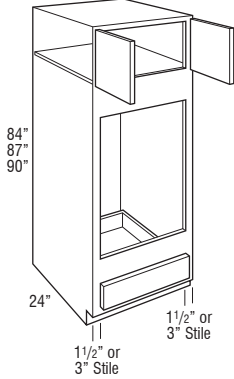

OCD_24

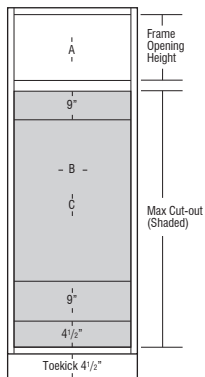

OCD_24N

Price Point

	1	2	3	4	5	6	7	8	9	10	11	12
OCD278424(N)	2024	2227	2260	2294	2327	2360	2494	2585	2681	2772	2838	3068
OCD308424(N)	2129	2342	2439	2536	2632	2728	2885	2995	3108	3210	3294	3559
OCD31.58424(N)	2296	2526	2607	2688	2770	2850	3014	3128	3245	3354	3441	3720
OCD338424(N)	2462	2708	2774	2840	2906	2972	3143	3261	3381	3498	3587	3880
OCD278724(N)	2234	2458	2494	2530	2566	2602	2750	2852	2958	3056	3133	3389
OCD308724(N)	2352	2587	2686	2783	2881	2978	3149	3268	3392	3507	3596	3886
OCD31.58724(N)	2471	2769	2857	2946	3033	3120	3300	3424	3554	3674	3769	4073
OCD338724(N)	2589	2950	3028	3107	3185	3263	3448	3578	3714	3840	3940	4259
OCD279024(N)	2463	2722	2753	2783	2813	2844	3004	3120	3236	3343	3429	3707
OCD309024(N)	2574	2943	3015	3086	3157	3228	3413	3541	3676	3799	3898	4216
OCD31.59024(N)	2720	3077	3155	3233	3312	3389	3584	3718	3861	3992	4095	4428
OCD339024(N)	2866	3209	3295	3380	3465	3550	3755	3895	4045	4184	4291	4641

- N represents Narrow Stile cabinets with 1 1/2" wide face frame side stiles and ACS modification availability (see page 13 for ACS specifications). Doors and drawer fronts have a consistent width reveal for full overlay (1/4") and partial overlay (1") and use standard soft-close hinges.
- On cabinets with 3" wide face frame side stiles, doors use face mount hinges. Doors and drawer fronts have a consistent width reveal for full overlay (1/4") and partial overlay (1").
- Cabinets with 3" wide face frames are not available in certain door styles. See Door Style section for exceptions.
- Upper section on 90" tall has one full depth adjustable shelf.
- All top and bottom cross rails are 1 1/2" wide.
- Be sure to confirm a heat shield is built into your appliance by the manufacturer or install the heat shield included with your appliance. Heat shields are sold separately as an accessory.
- For built-in appliance support, OCINSTALLKIT is included in 24" deep oven cabinets (see page 313 for details). Oven install kit will not be included when depth is modified.
- OCINSTALLKIT weight limit is 400 lbs. per pair.
- Oven cabinets feature an open back in cut-out area designed to improve field appliance installation.
- Maximum w/Drawer cut-out dimension will allow 1/4" reveal for doors and drawer fronts on full overlay and 1" for partial overlay for trim kit face clearance.
- If the maximum height (as shown in gray) is cut out, the drawer will no longer be included. See chart below for maximum cut-out allowed if you want to keep the drawer.

	A Frame Opening Height	B Cut-out Width (standard)			B Cut-out Width (with ACS modification)			C Cut-out Height			Door Height (Upper Section)	
		Min.	Min. (N)	Max.	Min.	Max.	Max. w/ Field Cut	Min.	Max. Keeps Bottom Drawer	Max. Replaces Bottom Drawer	Partial Overlay	Full Overlay
OCD278424(N)	15"	21"	24"	25 1/2"	21"	24"	25 1/2"	39"	54"	60"	16"	17 1/2"
OCD308424(N)	15"	24"	27"	28 1/2"	24"	27"	28 1/2"	39"	54"	60"	16"	17 1/2"
OCD31.58424(N)	15"	25 1/2"	28 1/2"	30"	25 1/2"	28 1/2"	30"	39"	54"	60"	16"	17 1/2"
OCD338424(N)	15"	27"	30"	31 1/2"	27"	30"	31 1/2"	39"	54"	60"	16"	17 1/2"
OCD278724(N)	18"	21"	24"	25 1/2"	21"	24"	25 1/2"	39"	54"	60"	19"	20 1/2"
OCD308724(N)	18"	24"	27"	28 1/2"	24"	27"	28 1/2"	39"	54"	60"	19"	20 1/2"
OCD31.58724(N)	18"	25 1/2"	28 1/2"	30"	25 1/2"	28 1/2"	30"	39"	54"	60"	19"	20 1/2"
OCD338724(N)	18"	27"	30"	31 1/2"	27"	30"	31 1/2"	39"	54"	60"	19"	20 1/2"
OCD279024(N)	21"	21"	24"	25 1/2"	21"	24"	25 1/2"	39"	54"	60"	22"	23 1/2"
OCD309024(N)	21"	24"	27"	28 1/2"	24"	27"	28 1/2"	39"	54"	60"	22"	23 1/2"
OCD31.59024(N)	21"	25 1/2"	28 1/2"	30"	25 1/2"	28 1/2"	30"	39"	54"	60"	22"	23 1/2"
OCD339024(N)	21"	27"	30"	31 1/2"	27"	30"	31 1/2"	39"	54"	60"	22"	23 1/2"

Custom Modifications

ACS	ADDTK	AUTH	CBO	CCO	CFNTO	CFRMO	CH	CND	CW	DRT	DRWTK	DRWWRM	EXBK	EX	FB	FFD	FPEB	FTK	FTK_V_ID	INVFRM	MIP	RD	RECTK	RT	TD	TKP	VTK	
• ¹	•	•	•	•	•	•	•	•	•	•	•	•	•	•	•	•	•	•	•	•	•	•	•	•	•	•	•	•

Construction Upgrades

APC	ET	PE
•	•	•

Door Options

CG	CG.TOP	DPSRR	MFO
• ¹	•	•	•

¹ Only available on Narrow Stile (N) cabinets

² Not available on 27" wide

**DOUBLE OVEN CABINET,
93" or 96" TALL, 24" DEEP**

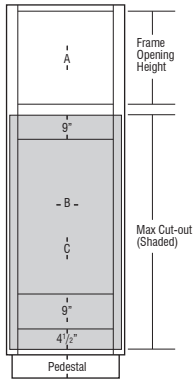
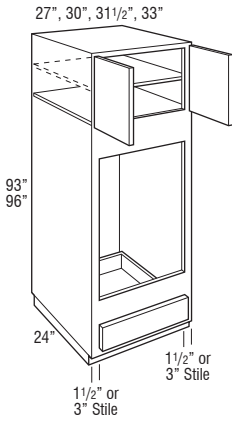

OCD_ _ _ 24

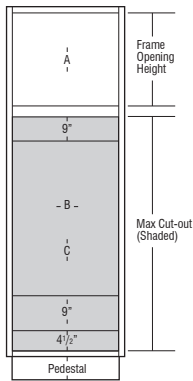

OCD_ _ _ 24N

Price Point

	1	2	3	4	5	6	7	8	9	10	11	12
OCD279324(N)	2949	3166	3207	3246	3285	3324	3517	3647	3783	3917	4014	4342
OCD309324(N)	3099	3386	3471	3555	3639	3723	3937	4087	4243	4387	4501	4869
OCD31.59324(N)	3257	3557	3649	3741	3833	3924	4152	4310	4473	4627	4748	5136
OCD339324(N)	3414	3727	3827	3927	4026	4125	4366	4533	4703	4865	4993	5403
OCD279624(N)	2949	3166	3207	3246	3285	3324	3517	3647	3783	3917	4014	4342
OCD309624(N)	3099	3386	3471	3555	3639	3723	3937	4087	4243	4387	4501	4869
OCD31.59624(N)	3257	3557	3649	3741	3833	3924	4152	4310	4473	4627	4748	5136
OCD339624(N)	3414	3727	3827	3927	4026	4125	4366	4533	4703	4865	4993	5403

- N represents Narrow Stile cabinets with 1 1/2" wide face frame side stiles and ACS modification availability (see page 13 for ACS specifications). Doors and drawer fronts have a consistent width reveal for full overlay (1/4") and partial overlay (1") and use standard soft-close hinges.
- On cabinets with 3" wide face frame side stiles, doors use face mount hinges. Doors and drawer fronts have a consistent width reveal for full overlay (1/4") and partial overlay (1").
- Cabinets with 3" wide face frames are not available in certain door styles. See Door Style section for exceptions.
- Includes adjustable shelves in upper section:
93" tall - one shelf
96" tall - two shelves
- All top and bottom cross rails are 1 1/2" wide.
- Be sure to confirm a heat shield is built into your appliance by the manufacturer or install the heat shield included with your appliance. Heat shields are sold separately as an accessory.
- For built-in appliance support, OCINSTALLKIT is included in 24" deep oven cabinets (see page 313 for details). Oven install kit will not be included when depth is modified.
- OCINSTALLKIT weight limit is 400 lbs. per pair.
- Oven cabinets feature an open back in cut-out area designed to improve field appliance installation.
- Maximum w/Drawer cut-out dimension will allow 1/4" reveal for doors and drawer fronts on full overlay and 1" for partial overlay for trim kit face clearance.
- If the maximum height (as shown in gray) is cut out, the drawer will no longer be included. See chart below for maximum cut-out allowed if you want to keep the drawer.

	A Frame Opening Height	B Cut-out Width (standard)			B Cut-out Width (with ACS modification)			C Cut-out Height			Door Height (Upper Section)	
		Min.	Min. (N)	Max.	Min.	Max.	Max. w/ Field Cut	Min.	Max. Keeps Bottom Drawer	Max. Replaces Bottom Drawer	Partial Overlay	Full Overlay
OCD279324(N)	24"	21"	24"	25 1/2"	21"	24"	25 1/2"	39"	54"	60"	25"	26 1/2"
OCD309324(N)	24"	24"	27"	28 1/2"	24"	27"	28 1/2"	39"	54"	60"	25"	26 1/2"
OCD31.59324(N)	24"	25 1/2"	28 1/2"	30"	25 1/2"	28 1/2"	30"	39"	54"	60"	25"	26 1/2"
OCD339324(N)	24"	27"	30"	31 1/2"	27"	30"	31 1/2"	39"	54"	60"	25"	26 1/2"
OCD279624(N)	27"	21"	24"	25 1/2"	21"	24"	25 1/2"	39"	54"	60"	28"	29 1/2"
OCD309624(N)	27"	24"	27"	28 1/2"	24"	27"	28 1/2"	39"	54"	60"	28"	29 1/2"
OCD31.59624(N)	27"	25 1/2"	28 1/2"	30"	25 1/2"	28 1/2"	30"	39"	54"	60"	28"	29 1/2"
OCD339624(N)	27"	27"	30"	31 1/2"	27"	30"	31 1/2"	39"	54"	60"	28"	29 1/2"

Custom Modifications

ACS	ADDTK	AUTH	CBO	CCO	CFNTO	CFRMO	CH	CND	CW	DRT	DRWTK	DRWWRM	EXBK	EX	FB	FFD	FPEB	FTK	FTK_V	ID	INVERM	MIP	RD	RECTK_	RT	TD	TKP	VTK
• ¹																												

Construction Upgrades

APC	ET	PE
•		•

Door Options

CG	CG.TOP	DPSRR	MFO
• ¹		•	•

¹ Only available on Narrow Stile (N) cabinets

² Not available on 27" wide

**DOUBLE OVEN CABINET,
DEEP DRAWER,
66" TALL, 24" DEEP**

27", 30", 31 1/2", 33"

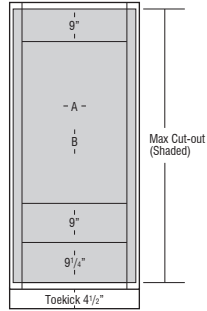
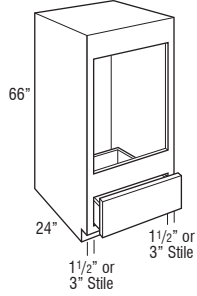

OCD_6624DD

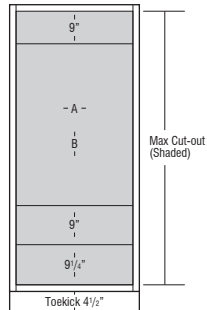

OCD_6624DDN

Price Point

	1	2	3	4	5	6	7	8	9	10	11	12
OCD276624DD(N)	1667	1834	1878	1922	1967	2010	2116	2189	2266	2333	2391	2568
OCD306624DD(N)	1822	2004	2096	2186	2277	2367	2495	2580	2669	2749	2815	3022
OCD31.56624DD(N)	2002	2202	2279	2354	2431	2508	2639	2729	2822	2908	2976	3194
OCD336624DD(N)	2181	2399	2461	2523	2585	2647	2783	2878	2976	3066	3137	3365

- N represents Narrow Stile cabinets with 1 1/2" wide face frame side stiles and ACS modification availability (see page 13 for ACS specifications). Drawer front has a consistent width reveal for full overlay (1/4") and partial overlay (1").
- All top and bottom cross rails are 1 1/2" wide.
- Be sure to confirm a heat shield is built into your appliance by the manufacturer or install the heat shield included with your appliance. Heat shields are sold separately as an accessory.
- For built-in appliance support, OCINSTALKIT is included in 24" deep oven cabinets (see page 313 for details). Oven install kit will not be included when depth is modified.
- OCINSTALKIT weight limit is 400 lbs. per pair.
- Maximum w/Drawer cut-out dimension will allow 1/4" reveal for drawer fronts on full overlay and 1" for partial overlay for trim kit face clearance.
- Oven cabinet cut-out is shaded in gray and is cut out on job site.
- If the maximum height (as shown in gray) is cut out, the drawer will no longer be included. See chart below for maximum cut-out allowed if you want to keep the drawer.

	A Cut-out Width (standard)			A Cut-out Width (with ACS modification)			B Cut-out Height		
	Min.	Min. (N)	Max.	Min.	Max.	Max. w/ Field Cut	Min.	Max. Keeps Bottom Drawer	Max. Replaces Bottom Drawer
OCD276624DD(N)	21"	24"	25 1/2"	21"	24"	25 1/2"	37 1/2"	52 1/2"	58 1/2"
OCD306624DD(N)	24"	27"	28 1/2"	24"	27"	28 1/2"	37 1/2"	52 1/2"	58 1/2"
OCD31.56624DD(N)	25 1/2"	28 1/2"	30"	25 1/2"	28 1/2"	30"	37 1/2"	52 1/2"	58 1/2"
OCD336624DD(N)	27"	30"	31 1/2"	27"	30"	31 1/2"	37 1/2"	52 1/2"	58 1/2"

Custom Modifications

ACS	ADDTK	AUTH	CBO	CCO	CFNTO	CFRMO	CH	CND	CW	DRT	DRWTK	DRWRM	EXBK	EX	FB	FFD	FPEB	FTK	FTK_V	ID	INFRM	MIP	RD	RECTK_RT	TD	TKP	VTK
• ¹	•	•	•	•	•	•	•	•	•	• ²	•	•	•	•	•	•	•	•	•	•	•	•	•	•	•	•	•

Construction Upgrades

APC	ET	PE
•	•	•

Door Options

CG	CG.TOP	DPSRR	MFO
•	•	•	•

¹ Only available on Narrow Stile (N) cabinets
² Not available on 27" wide

**DOUBLE OVEN CABINET,
DEEP DRAWER,
84", 87", or 90" TALL, 24" DEEP**

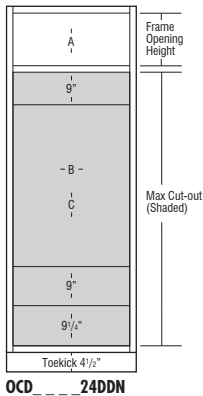
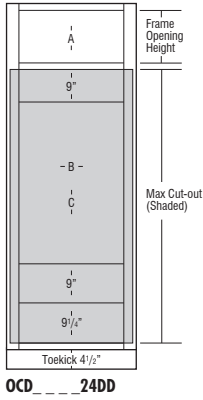
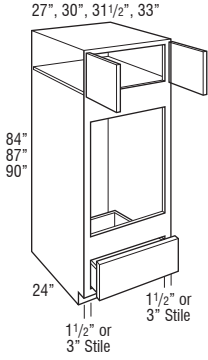

Price Point	1	2	3	4	5	6	7	8	9	10	11	12
OCD278424DD(N)	2314	2546	2607	2669	2731	2791	2938	3040	3147	3240	3320	3566
OCD308424DD(N)	2530	2783	2910	3035	3162	3287	3464	3582	3706	3818	3909	4197
OCD31.58424DD(N)	2780	3058	3164	3269	3376	3482	3665	3790	3919	4038	4133	4435
OCD338424DD(N)	3028	3331	3417	3503	3590	3676	3864	3997	4132	4257	4356	4673
OCD278724DD(N)	2547	2801	2866	2930	2994	3058	3219	3332	3452	3555	3643	3920
OCD308724DD(N)	2712	3163	3263	3362	3462	3560	3751	3883	4019	4142	4243	4558
OCD31.58724DD(N)	2928	3353	3460	3565	3671	3777	3976	4116	4258	4388	4493	4825
OCD338724DD(N)	3144	3543	3656	3768	3881	3993	4201	4348	4497	4633	4743	5090
OCD279024DD(N)	2788	3099	3156	3212	3268	3324	3499	3625	3754	3872	3966	4269
OCD309024DD(N)	3000	3408	3515	3621	3727	3834	4040	4182	4330	4465	4572	4919
OCD31.59024DD(N)	3223	3616	3731	3845	3959	4072	4290	4440	4595	4738	4851	5215
OCD339024DD(N)	3446	3825	3947	4068	4190	4311	4539	4696	4860	5010	5130	5509

- N represents Narrow Stile cabinets with 1 1/2" wide face frame side stiles and ACS modification availability (see page 13 for ACS specifications). Doors and drawer fronts have a consistent width reveal for full overlay (1/4") and partial overlay (1") and use standard soft-close hinges.
- On cabinets with 3" wide face frame side stiles, doors use face mount hinges. Doors and drawer fronts have a consistent width reveal for full overlay (1/4") and partial overlay (1").
- All top and bottom cross rails are 1 1/2" wide.
- Be sure to confirm a heat shield is built into your appliance by the manufacturer or install the heat shield included with your appliance. Heat shields are sold separately as an accessory.
- For built-in appliance support, OCINSTALLKIT is included in 24" deep oven cabinets (see page 313 for details). Oven install kit will not be included when depth is modified.
- OCINSTALLKIT weight limit is 400 lbs. per pair.
- Oven cabinets feature an open back in cut-out area designed to improve field appliance installation.
- Maximum w/Drawer cut-out dimension will allow 1/4" reveal for doors and drawer fronts on full overlay and 1" for partial overlay for trim kit face clearance.
- If the maximum height (as shown in gray) is cut out, the drawer will no longer be included. See chart below for maximum cut-out allowed if you want to keep the drawer.

	A Frame Opening Height	B Cut-out Width (standard)			B Cut-out Width (with ACS modification)			C Cut-out Height			Door Height (Upper Section)	
		Min.	Min. (N)	Max.	Min.	Max.	Max. w/ Field Cut	Min.	Max. Keeps Bottom Drawer	Max. Replaces Bottom Drawer	Partial Overlay	Full Overlay
OCD278424DD(N)	12"	21"	24"	25 1/2"	21"	24"	25 1/2"	37 1/4"	52 1/4"	63"	13"	14 1/2"
OCD308424DD(N)	12"	24"	27"	28 1/2"	24"	27"	28 1/2"	37 1/4"	52 1/4"	63"	13"	14 1/2"
OCD31.58424DD(N)	12"	25 1/2"	28 1/2"	30"	25 1/2"	28 1/2"	30"	37 1/4"	52 1/4"	63"	13"	14 1/2"
OCD338424DD(N)	12"	27"	30"	31 1/2"	27"	30"	31 1/2"	37 1/4"	52 1/4"	63"	13"	14 1/2"
OCD278724DD(N)	15"	21"	24"	25 1/2"	21"	24"	25 1/2"	37 1/4"	52 1/4"	63"	16"	17 1/2"
OCD308724DD(N)	15"	24"	27"	28 1/2"	24"	27"	28 1/2"	37 1/4"	52 1/4"	63"	16"	17 1/2"
OCD31.58724DD(N)	15"	25 1/2"	28 1/2"	30"	25 1/2"	28 1/2"	30"	37 1/4"	52 1/4"	63"	16"	17 1/2"
OCD338724DD(N)	15"	27"	30"	31 1/2"	27"	30"	31 1/2"	37 1/4"	52 1/4"	63"	16"	17 1/2"
OCD279024DD(N)	18"	21"	24"	25 1/2"	21"	24"	25 1/2"	37 1/4"	52 1/4"	63"	19"	20 1/2"
OCD309024DD(N)	18"	24"	27"	28 1/2"	24"	27"	28 1/2"	37 1/4"	52 1/4"	63"	19"	20 1/2"
OCD31.59024DD(N)	18"	25 1/2"	28 1/2"	30"	25 1/2"	28 1/2"	30"	37 1/4"	52 1/4"	63"	19"	20 1/2"
OCD339024DD(N)	18"	27"	30"	31 1/2"	27"	30"	31 1/2"	37 1/4"	52 1/4"	63"	19"	20 1/2"

Custom Modifications

ACS	ADTK	AUTH	CBO	CCO	CFNTO	CFRMO	CH	CND	CW	DRT	DRWTK	DRWWRM	EXBK	EX	FB	FFD	FPEB	FTK	FTK_V	ID	INVRM	MIP	RD	RECTK	RT	TD	TKP	VTK	
• ¹		•	•	•							• ²			•	•	•	•	•	•	•	•		•	•	•	•	• ³	•	•

Construction Upgrades

APC	ET	PE
•		•

Door Options

CG	CG.TOP	DPSRR	MFO
• ¹		•	•

¹ Only available on Narrow Stile (N) cabinets

² Not available on 27" wide

³ Not available on 84" tall

**DOUBLE OVEN CABINET,
DEEP DRAWER,
93" or 96" TALL, 24" DEEP**

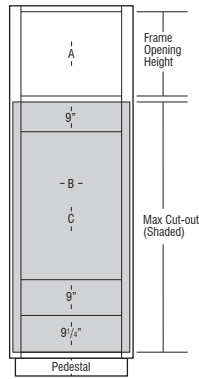
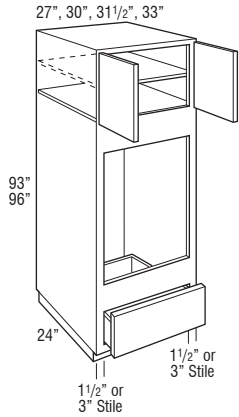

OCD -- 24DD

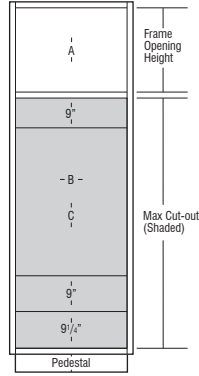

OCD -- 24DDN

Price Point

	1	2	3	4	5	6	7	8	9	10	11	12
OCD279324DD(N)	3323	3563	3636	3707	3779	3851	4061	4207	4360	4501	4611	4968
OCD309324DD(N)	3580	3898	4019	4140	4260	4380	4617	4786	4956	5112	5238	5639
OCD31.59324DD(N)	3815	4146	4276	4405	4535	4664	4915	5090	5272	5438	5571	5992
OCD339324DD(N)	4049	4394	4533	4670	4808	4946	5212	5394	5588	5762	5902	6345
OCD279624DD(N)	3323	3563	3636	3707	3779	3851	4061	4207	4360	4501	4611	4968
OCD309624DD(N)	3580	3898	4019	4140	4260	4380	4617	4786	4956	5112	5238	5639
OCD31.59624DD(N)	3770	4100	4230	4360	4490	4619	4870	5047	5226	5392	5526	5992
OCD339624DD(N)	3960	4302	4441	4580	4719	4856	5122	5307	5495	5671	5813	6345

- N represents Narrow Stile cabinets with 1 1/2" wide face frame side stiles and ACS modification availability (see page 13 for ACS specifications). Doors and drawer fronts have a consistent width reveal for full overlay (1/4") and partial overlay (1") and use standard soft-close hinges.
- On cabinets with 3" wide face frame side stiles, doors use face mount hinges. Doors and drawer fronts have a consistent width reveal for full overlay (1/4") and partial overlay (1").
- All top and bottom cross rails are 1 1/2" wide.
- Be sure to confirm a heat shield is built into your appliance by the manufacturer or install the heat shield included with your appliance. Heat shields are sold separately as an accessory.
- One full depth adjustable shelf included, but packaged separately.
- For built-in appliance support, OCINSTALKIT is included in 24" deep oven cabinets (see page 313 for details). Oven install kit will not be included when depth is modified.
- OCINSTALKIT weight limit is 400 lbs. per pair.
- Oven cabinets feature an open back in cut-out area designed to improve field appliance installation.
- Maximum w/Drawer cut-out dimension will allow 1/4" reveal for doors and drawer fronts on full overlay and 1" for partial overlay for trim kit face clearance.
- If the maximum height (as shown in gray) is cut out, the drawer will no longer be included. See chart below for maximum cut-out allowed if you want to keep the drawer.

	A Frame Opening Height	B Cut-out Width (standard)			B Cut-out Width (with ACS modification)			C Cut-out Height			Door Height (Upper Section)	
		Min.	Min. (N)	Max.	Min.	Max.	Max. w/ Field Cut	Min.	Max. Keeps Bottom Drawer	Max. Replaces Bottom Drawer	Partial Overlay	Full Overlay
OCD279324DD(N)	21"	21"	24"	25 1/2"	21"	24"	25 1/2"	37 1/4"	52 1/4"	63"	22"	23 1/2"
OCD309324DD(N)	21"	24"	27"	28 1/2"	24"	27"	28 1/2"	37 1/4"	52 1/4"	63"	22"	23 1/2"
OCD31.59324DD(N)	21"	25 1/2"	28 1/2"	30"	25 1/2"	28 1/2"	30"	37 1/4"	52 1/4"	63"	22"	23 1/2"
OCD339324DD(N)	21"	27"	30"	31 1/2"	27"	30"	31 1/2"	37 1/4"	52 1/4"	63"	22"	23 1/2"
OCD279624DD(N)	24"	21"	24"	25 1/2"	21"	24"	25 1/2"	37 1/4"	52 1/4"	63"	25"	26 1/2"
OCD309624DD(N)	24"	24"	27"	28 1/2"	24"	27"	28 1/2"	37 1/4"	52 1/4"	63"	25"	26 1/2"
OCD31.59624DD(N)	24"	25 1/2"	28 1/2"	30"	25 1/2"	28 1/2"	30"	37 1/4"	52 1/4"	63"	25"	26 1/2"
OCD339624DD(N)	24"	27"	30"	31 1/2"	27"	30"	31 1/2"	37 1/4"	52 1/4"	63"	25"	26 1/2"

Custom Modifications

ACS	ADDTK	AUTH	CBO	CCO	CFNTO	CFRMO	CH	CND	CW	DRT	DRWTK	DRWRM	EXBK	EX	FB	FFD	FPEB	FTK	FTK_V	ID	INFRM	MIP	RD	RECTK_RT	TD	TGP	VTK	
• ¹																												

Construction Upgrades

APC	ET	PE
•		•

Door Options

CG	CG.TOP	DPSRR	MFO
• ¹		•	•

¹ Only available on Narrow Stile (N) cabinets

² Not available on 27" wide

TALL BUILT-IN MICROWAVE CABINET, 84", 87", or 90" TALL, 24" DEEP

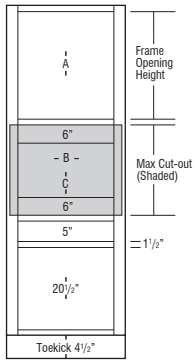
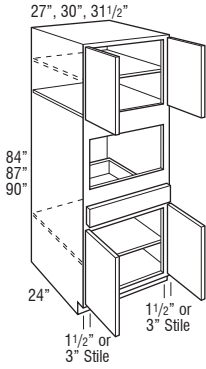

TBMWB --- 24

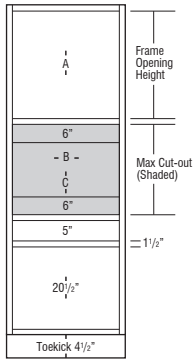

TBMWB --- 24N

Price Point

	1	2	3	4	5	6	7	8	9	10	11	12
TBMWB278424(N)	2256	2598	2629	2659	2689	2718	2871	2975	3087	3195	3273	3536
TBMWB308424(N)	2448	2694	2808	2922	3036	3149	3331	3451	3585	3705	3800	4107
TBMWB31.58424(N)	2644	2909	3033	3156	3279	3401	3597	3726	3872	4002	4104	4435
TBMWB278724(N)	2541	2867	2901	2933	2966	2998	3167	3288	3410	3527	3614	3905
TBMWB308724(N)	2659	3135	3211	3286	3362	3437	3634	3771	3916	4045	4150	4487
TBMWB31.58724(N)	2872	3386	3468	3549	3631	3713	3926	4072	4229	4369	4481	4845
TBMWB279024(N)	2824	3135	3171	3205	3241	3276	3465	3597	3731	3858	3955	4276
TBMWB309024(N)	2962	3390	3474	3558	3642	3725	3938	4087	4243	4386	4500	4869
TBMWB31.59024(N)	3200	3661	3752	3843	3933	4023	4253	4414	4582	4736	4860	5258

- N represents Narrow Stile cabinets with 1 1/2" wide face frame side stiles and ACS modification availability (see page 13 for ACS specifications). Doors and drawer fronts have a consistent width reveal for full overlay (1/4") and partial overlay (1") and use standard soft-close hinges.
- On cabinets with 3" wide face frame side stiles, doors use face mount hinges. Doors and drawer fronts have a consistent width reveal for full overlay (1/4") and partial overlay (1").
- Cabinets with 3" wide face frames are not available in certain door styles. See Door Style section for exceptions.
- Includes adjustable shelves in upper section:
84" tall - one shelf
87"-90" tall - two shelves
- Base section will utilize a full depth shelf.
- All top and bottom cross rails are 1 1/2" wide.
- All toekick areas are 4 1/2" high.
- Includes OCINSTALLKIT for microwave installation.
- OCINSTALLKIT weight limit is 400 lbs. per pair.
- Maximum cut-out dimension will allow 1/4" reveal for doors and drawer fronts on full overlay and 1" for partial overlay for trim kit face clearance.
- Oven cabinet cut-out is shaded in gray and is cut out on job site.

	A Frame Opening Height	B Cut-out Width (standard)			B Cut-out Width (with ACS modification)			C Cut-out Height		Door Height (Upper Section)	
		Min.	Min. (N)	Max.	Min.	Max.	Max. w/ Field Cut	Min.	Max.	Partial Overlay	Full Overlay
TBMWB278424(N)	24"	21"	24"	25 1/2"	21"	24"	25 1/2"	13 1/2"	22 1/2"	25"	26 1/2"
TBMWB308424(N)	24"	24"	27"	28 1/2"	24"	27"	28 1/2"	13 1/2"	22 1/2"	25"	26 1/2"
TBMWB31.58424(N)	24"	25 1/2"	28 1/2"	30"	25 1/2"	28 1/2"	30"	13 1/2"	22 1/2"	25"	26 1/2"
TBMWB278724(N)	27"	21"	24"	25 1/2"	21"	24"	25 1/2"	13 1/2"	22 1/2"	28"	29 1/2"
TBMWB308724(N)	27"	24"	27"	28 1/2"	24"	27"	28 1/2"	13 1/2"	22 1/2"	28"	29 1/2"
TBMWB31.58724(N)	27"	25 1/2"	28 1/2"	30"	25 1/2"	28 1/2"	30"	13 1/2"	22 1/2"	28"	29 1/2"
TBMWB279024(N)	30"	21"	24"	25 1/2"	21"	24"	25 1/2"	13 1/2"	22 1/2"	31"	32 1/2"
TBMWB309024(N)	30"	24"	27"	28 1/2"	24"	27"	28 1/2"	13 1/2"	22 1/2"	31"	32 1/2"
TBMWB31.59024(N)	30"	25 1/2"	28 1/2"	30"	25 1/2"	28 1/2"	30"	13 1/2"	22 1/2"	31"	32 1/2"

Custom Modifications

ACS	ADDTK	AUTH	CBO	CCO	CFNTO	CFRMO	CH	CND	CW	DRT	DRWTK	DRWWRM	EXBK	EX	FB	FFD	FPEB	FTK	FTK_V	ID	INVERM	MIP	RD	RECTK_	RT	TD	TKP	VTK
• ¹		•	•	•			•	•	•	• ²	•		•	•	•		•	•	•				•	•	•	•	• ³	•

Construction Upgrades

APC	ET	PE
•		•

Door Options

CG	CG.TOP	DPSRR	MFO
	• ¹	•	•

¹ Only available on Narrow Stile (N) cabinets

² Not available on 27" wide

³ Not available on 90" tall

TALL BUILT-IN MICROWAVE CABINET, 93" or 96" TALL, 24" DEEP

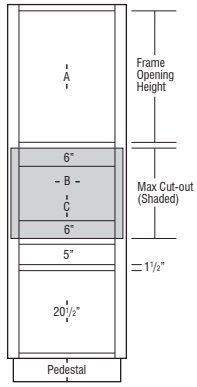
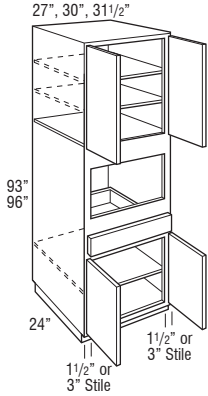

TBMWB ___ 24

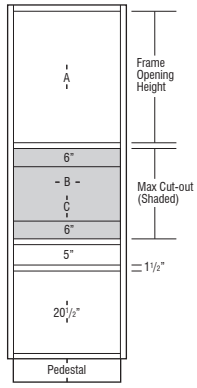

TBMWB ___ 24N

Price Point

	1	2	3	4	5	6	7	8	9	10	11	12
TBMWB279324(N)	3389	3644	3693	3740	3787	3834	4057	4208	4367	4518	4637	5014
TBMWB309324(N)	3566	3909	4007	4105	4202	4300	4548	4721	4900	5072	5204	5628
TBMWB31.59324(N)	3852	4221	4328	4433	4538	4644	4912	5098	5292	5478	5620	6078
TBMWB279624(N)	3389	3644	3693	3740	3787	3834	4057	4208	4367	4518	4637	5014
TBMWB309624(N)	3566	3909	4007	4105	4202	4300	4548	4721	4900	5072	5204	5628
TBMWB31.59624(N)	3852	4221	4328	4433	4538	4644	4912	5098	5292	5478	5620	6078

- N represents Narrow Stile cabinets with 1 1/2" wide face frame side stiles and ACS modification availability (see page 13 for ACS specifications). Doors and drawer fronts have a consistent width reveal for full overlay (1/4") and partial overlay (1") and use standard soft-close hinges.
- On cabinets with 3" wide face frame side stiles, doors use face mount hinges. Doors and drawer fronts have a consistent width reveal for full overlay (1/4") and partial overlay (1").
- Cabinets with 3" wide face frames are not available in certain door styles. See Door Style section for exceptions.
- Includes adjustable shelves in upper section:
93" tall - two shelves
96" tall - three shelves
- Base section will utilize a full depth shelf.
- All top and bottom cross rails are 1 1/2" wide.
- All toekick areas are 4 1/2" high.
- Includes OCINSTALLKIT for microwave installation.
- OCINSTALLKIT weight limit is 400 lbs. per pair.
- Maximum cut-out dimension will allow 1/4" reveal for doors and drawer fronts on full overlay and 1" for partial overlay for trim kit face clearance.
- Oven cabinet cut-out is shaded in gray and is cut out on job site.

	A Frame Opening Height	B Cut-out Width (standard)			B Cut-out Width (with ACS modification)			C Cut-out Height		Door Height (Upper Section)	
		Min.	Min. (N)	Max.	Min.	Max.	Max. w/ Field Cut	Min.	Max.	Partial Overlay	Full Overlay
TBMWB279324(N)	33"	21"	24"	25 1/2"	21"	24"	25 1/2"	13 1/2"	22 1/2"	34"	35 1/2"
TBMWB309324(N)	33"	24"	27"	28 1/2"	24"	27"	28 1/2"	13 1/2"	22 1/2"	34"	35 1/2"
TBMWB31.59324(N)	33"	25 1/2"	28 1/2"	30"	25 1/2"	28 1/2"	30"	13 1/2"	22 1/2"	34"	35 1/2"
TBMWB279624(N)	36"	21"	24"	25 1/2"	21"	24"	25 1/2"	13 1/2"	22 1/2"	37"	38 1/2"
TBMWB309624(N)	36"	24"	27"	28 1/2"	24"	27"	28 1/2"	13 1/2"	22 1/2"	37"	38 1/2"
TBMWB31.59624(N)	36"	25 1/2"	28 1/2"	30"	25 1/2"	28 1/2"	30"	13 1/2"	22 1/2"	37"	38 1/2"

Custom Modifications

ACS	ADDTK	AUTH	CBO	CCO	CFNTO	CFRMO	CH	CND	CW	DRT	DRWTK	DRWWRM	EXBK	EX	FB	FFD	FPEB	FTK	FTK_V	ID	INFRM	MIP	RD	RECTK_RT	TD	TKP	VTK
• ¹	•	•	•	•	•	•	•	•	•	• ²	•	•	•	•	•	•	•	•	•	•	•	•	•	•	•	•	•

Construction Upgrades

APC	ET	PE
•	•	•

Door Options

CG	CG.TOP	DPSRR	MFO
• ¹	•	•	•

¹ Only available on Narrow Stile (N) cabinets
² Not available on 27" wide

TALL BUILT-IN MICROWAVE CABINET, THREE DRAWER BASE, 84", 87", or 90" TALL, 24" DEEP

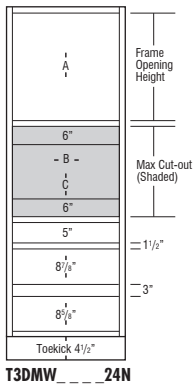
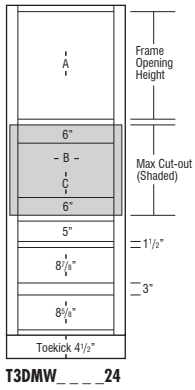
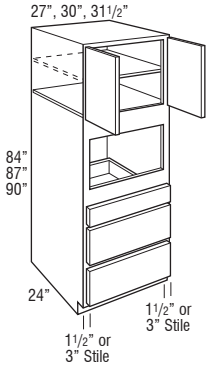

Price Point

	1	2	3	4	5	6	7	8	9	10	11	12
T3DMW278424(N)	2731	3073	3104	3134	3164	3193	3346	3450	3562	3670	3748	4011
T3DMW308424(N)	2923	3169	3283	3397	3511	3624	3806	3926	4060	4180	4275	4582
T3DMW31.58424(N)	3119	3384	3508	3631	3754	3876	4072	4201	4347	4477	4579	4910
T3DMW278724(N)	3016	3342	3376	3408	3441	3473	3642	3763	3885	4002	4089	4380
T3DMW308724(N)	3134	3610	3686	3761	3837	3912	4109	4246	4391	4520	4625	4962
T3DMW31.58724(N)	3347	3861	3943	4024	4106	4188	4401	4547	4704	4844	4956	5320
T3DMW279024(N)	3299	3610	3646	3680	3716	3751	3940	4072	4206	4333	4430	4751
T3DMW309024(N)	3437	3865	3949	4033	4117	4200	4413	4562	4718	4861	4975	5344
T3DMW31.59024(N)	3675	4136	4227	4318	4408	4498	4728	4889	5057	5211	5335	5733

- N represents Narrow Stile cabinets with 1 1/2" wide face frame side stiles and ACS modification availability (see page 13 for ACS specifications). Doors and drawer fronts have a consistent width reveal for full overlay (1/4") and partial overlay (1") and use standard soft-close hinges.
- On cabinets with 3" wide face frame side stiles, doors use face mount hinges. Doors and drawer fronts have a consistent width reveal for full overlay (1/4") and partial overlay (1").
- Cabinets with 3" wide face frames are not available in certain door styles. See Door Style section for exceptions.
- Includes adjustable shelves in upper section:
 - 84" tall - one shelf
 - 87"-90" tall - two shelves
- All top and bottom cross rails are 1 1/2" wide.
- All toekick areas are 4 1/2" high.
- Exterior height of bottom 2 drawer boxes is 6 3/8".
- Includes OCINSTALLKIT for microwave installation.
- OCINSTALLKIT weight limit is 400 lbs. per pair.
- Maximum cut-out dimension will allow 1/4" reveal for doors and drawer fronts on full overlay and 1" for partial overlay for trim kit face clearance.
- Oven cabinet cut-out is shaded in gray and is cut out on job site.

	A Frame Opening Height	B Cut-out Width (standard)			B Cut-out Width (with ACS modification)			C Cut-out Height		Door Height (Upper Section)	
		Min.	Min. (N)	Max.	Min.	Max.	Max. w/ Field Cut	Min.	Max.	Partial Overlay	Full Overlay
T3DMW278424(N)	24"	21"	24"	25 1/2"	21"	24"	25 1/2"	13 1/2"	22 1/2"	25"	26 1/2"
T3DMW308424(N)	24"	24"	27"	28 1/2"	24"	27"	28 1/2"	13 1/2"	22 1/2"	25"	26 1/2"
T3DMW31.58424(N)	24"	25 1/2"	28 1/2"	30"	25 1/2"	28 1/2"	30"	13 1/2"	22 1/2"	25"	26 1/2"
T3DMW278724(N)	27"	21"	24"	25 1/2"	21"	24"	25 1/2"	13 1/2"	22 1/2"	28"	29 1/2"
T3DMW308724(N)	27"	24"	27"	28 1/2"	24"	27"	28 1/2"	13 1/2"	22 1/2"	28"	29 1/2"
T3DMW31.58724(N)	27"	25 1/2"	28 1/2"	30"	25 1/2"	28 1/2"	30"	13 1/2"	22 1/2"	28"	29 1/2"
T3DMW279024(N)	30"	21"	24"	25 1/2"	21"	24"	25 1/2"	13 1/2"	22 1/2"	31"	32 1/2"
T3DMW309024(N)	30"	24"	27"	28 1/2"	24"	27"	28 1/2"	13 1/2"	22 1/2"	31"	32 1/2"
T3DMW31.59024(N)	30"	25 1/2"	28 1/2"	30"	25 1/2"	28 1/2"	30"	13 1/2"	22 1/2"	31"	32 1/2"

Custom Modifications

ACS	ADDTK	AUTH	CBO	CCO	CFNTO	CFRMO	CH	CND	CW	DRT	DRWTK	DRWWRM	EXBK	EX	FB	FFD	FPEB	FTK	FTK_V	ID	INVERM	MIP	RD	RECTK_	RT	TD	TKP	VTK
• ¹		•	•	•			•	•	•	• ²	•	•	•	•	•	•	•	•	•	•	•	•	•	•	•	•	•	• ³

Construction Upgrades

APC	ET	PE
•		•

Door Options

CG	CG.TOP	DPSRR	MFO
• ¹		•	•

¹ Only available on Narrow Stile (N) cabinets
² Not available on 27" wide
³ Not available on 90" tall

TALL BUILT-IN MICROWAVE CABINET, THREE DRAWER BASE, 93" or 96" TALL, 24" DEEP

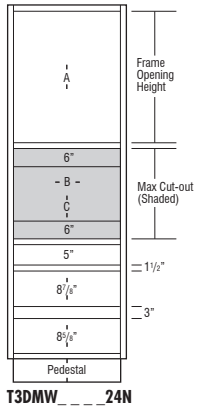
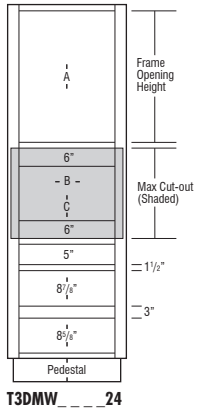
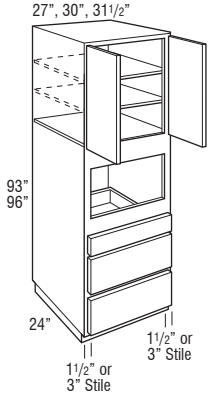

Price Point

	1	2	3	4	5	6	7	8	9	10	11	12
T3DMW279324(N)	3864	4119	4168	4215	4262	4309	4532	4683	4842	4993	5112	5489
T3DMW309324(N)	4041	4384	4482	4580	4677	4775	5023	5196	5375	5547	5679	6103
T3DMW31.59324(N)	4327	4696	4803	4908	5013	5119	5387	5573	5767	5953	6095	6553
T3DMW279624(N)	3864	4119	4168	4215	4262	4309	4532	4683	4842	4993	5112	5489
T3DMW309624(N)	4041	4384	4482	4580	4677	4775	5023	5196	5375	5547	5679	6103
T3DMW31.59624(N)	4327	4696	4803	4908	5013	5119	5387	5573	5767	5953	6095	6553

- N represents Narrow Stile cabinets with 1 1/2" wide face frame side stiles and ACS modification availability (see page 13 for ACS specifications). Doors and drawer fronts have a consistent width reveal for full overlay (1/4") and partial overlay (1") and use standard soft-close hinges.
- On cabinets with 3" wide face frame side stiles, doors use face mount hinges. Doors and drawer fronts have a consistent width reveal for full overlay (1/4") and partial overlay (1").
- Cabinets with 3" wide face frames are not available in certain door styles. See Door Style section for exceptions.
- Includes adjustable shelves in upper section:
93" tall - two shelves
96" tall - three shelves
- All top and bottom cross rails are 1 1/2" wide.
- All toekick areas are 4 1/2" high.
- Exterior height of bottom 2 drawer boxes is 6 3/8".
- Includes OCINSTALLKIT for microwave installation.
- OCINSTALLKIT weight limit is 400 lbs. per pair.
- Maximum cut-out dimension will allow 1/4" reveal for doors and drawer fronts on full overlay and 1" for partial overlay for trim kit face clearance.
- Oven cabinet cut-out is shaded in gray and is cut out on job site.

	A Frame Opening Height	B Cut-out Width (standard)			B Cut-out Width (with ACS modification)			C Cut-out Height		Door Height (Upper Section)	
		Min.	Min. (N)	Max.	Min.	Max.	Max. w/ Field Cut	Min.	Max.	Partial Overlay	Full Overlay
T3DMW279324(N)	33"	21"	24"	25 1/2"	21"	24"	25 1/2"	13 1/2"	22 1/2"	34"	35 1/2"
T3DMW309324(N)	33"	24"	27"	28 1/2"	24"	27"	28 1/2"	13 1/2"	22 1/2"	34"	35 1/2"
T3DMW31.59324(N)	33"	25 1/2"	28 1/2"	30"	25 1/2"	28 1/2"	30"	13 1/2"	22 1/2"	34"	35 1/2"
T3DMW279624(N)	36"	21"	24"	25 1/2"	21"	24"	25 1/2"	13 1/2"	22 1/2"	37"	38 1/2"
T3DMW309624(N)	36"	24"	27"	28 1/2"	24"	27"	28 1/2"	13 1/2"	22 1/2"	37"	38 1/2"
T3DMW31.59624(N)	36"	25 1/2"	28 1/2"	30"	25 1/2"	28 1/2"	30"	13 1/2"	22 1/2"	37"	38 1/2"

Custom Modifications

ACS	ADDTK	AUTH	CBO	CCO	CFNTO	CFRMO	CH	CND	CW	DRT	DRWTK	DRWWRM	EXBK	EX	FB	FFD	FPEB	FTK	FTK_V	ID	INFRM	MIP	RD	RECTK_	RT	TD	TKP	VTK	
• ¹																													

Construction Upgrades

APC	ET	PE
•		•

Door Options

CG	CG.TOP	DPSRR	MFO
• ¹		•	•

¹ Only available on Narrow Stile (N) cabinets
² Not available on 27" wide

**OVEN MICROWAVE CABINET,
84", 87", or 90" TALL, 24" DEEP**

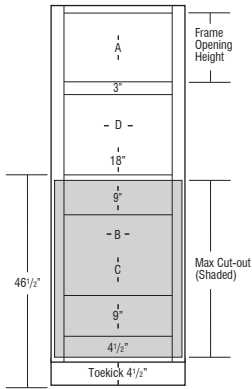
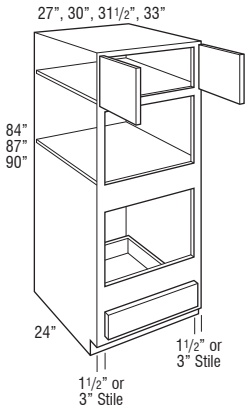

OMC _ _ 24

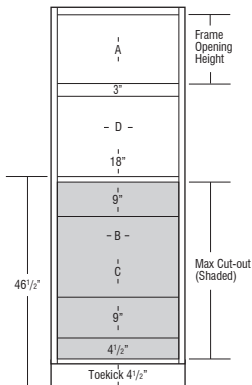

OMC _ _ 24N

Price Point

	1	2	3	4	5	6	7	8	9	10	11	12
OMC278424(N)	2050	2364	2391	2418	2445	2471	2610	2704	2806	2904	2975	3214
OMC308424(N)	2227	2449	2554	2657	2761	2864	3027	3136	3259	3368	3454	3734
OMC31.58424(N)	2400	2641	2729	2817	2905	2993	3163	3279	3406	3520	3612	3903
OMC338424(N)	2574	2831	2904	2977	3050	3121	3297	3423	3553	3672	3769	4072
OMC278724(N)	2311	2607	2638	2667	2697	2726	2880	2989	3100	3207	3286	3552
OMC308724(N)	2417	2849	2919	2987	3056	3125	3305	3427	3559	3677	3773	4080
OMC31.58724(N)	2565	2969	3046	3121	3199	3274	3462	3592	3728	3854	3956	4277
OMC338724(N)	2712	3089	3173	3256	3340	3423	3618	3755	3898	4030	4137	4473
OMC279024(N)	2567	2849	2882	2914	2947	2979	3149	3268	3392	3509	3595	3886
OMC309024(N)	2694	3081	3157	3233	3310	3386	3580	3714	3857	3986	4091	4425
OMC31.59024(N)	2847	3222	3306	3389	3473	3556	3759	3902	4051	4188	4299	4650
OMC339024(N)	3000	3363	3454	3545	3636	3725	3938	4090	4244	4388	4506	4874

- N represents Narrow Stile cabinets with 1 1/2" wide face frame side stiles and ACS modification availability (see page 13 for ACS specifications). Doors and drawer fronts have a consistent width reveal for full overlay (1/4") and partial overlay (1") and use standard soft-close hinges.
- On cabinets with 3" wide face frame side stiles, doors use face mount hinges. Doors and drawer fronts have a consistent width reveal for full overlay (1/4") and partial overlay (1").
- Cabinets with 3" wide face frames are not available in certain door styles. See Door Style section for exceptions.
- Upper section on 90" tall has one full depth adjustable shelf.
- Designed for use with separate built-in microwave above, built-in oven below. For built-in double ovens, see pages 197-202.
- All top and bottom cross rails are 1 1/2" wide.
- All toe kick areas are 4 1/2" high.
- Be sure to confirm a heat shield is built into your appliance by the manufacturer or install the heat shield included with your appliance. Heat shields are sold separately as an accessory.
- For built-in appliance support, OCINSTALLKIT is included in 24" deep oven cabinets (see page 313 for details). Oven install kit will not be included when depth is modified.
- OCINSTALLKIT weight limit is 400 lbs. per pair.
- Maximum w/Drawer cut-out dimension will allow 1/4" reveal for doors and drawer fronts on full overlay and 1" for partial overlay for trim kit face clearance.
- Oven cabinets feature an open back in cut-out area designed to improve field appliance installation.
- If the maximum height (as shown in gray) is cut out, the drawer will no longer be included. See chart below for maximum cut-out allowed if you want to keep the drawer.

	A Frame Opening Height	B/D Cut-out Width (standard)			B Cut-out Width (with ACS modification)			C Cut-out Height			Door Height (Upper Section)	
		Min.	Min. (N)	Max.	Min.	Max.	Max. w/ Field Cut	Min.	Max. Keeps Bottom Drawer	Max. Replaces Bottom Drawer	Partial Overlay	Full Overlay
OMC278424(N)	15"	21"	24"	25 1/2"	21"	24"	25 1/2"	18"	33"	39"	16"	17 1/2"
OMC308424(N)	15"	24"	27"	28 1/2"	24"	27"	28 1/2"	18"	33"	39"	16"	17 1/2"
OMC31.58424(N)	15"	25 1/2"	28 1/2"	30"	25 1/2"	28 1/2"	30"	18"	33"	39"	16"	17 1/2"
OMC338424(N)	15"	27"	30"	31 1/2"	27"	30"	31 1/2"	18"	33"	39"	16"	17 1/2"
OMC278724(N)	18"	21"	24"	25 1/2"	21"	24"	25 1/2"	18"	33"	39"	19"	20 1/2"
OMC308724(N)	18"	24"	27"	28 1/2"	24"	27"	28 1/2"	18"	33"	39"	19"	20 1/2"
OMC31.58724(N)	18"	25 1/2"	28 1/2"	30"	25 1/2"	28 1/2"	30"	18"	33"	39"	19"	20 1/2"
OMC338724(N)	18"	27"	30"	31 1/2"	27"	30"	31 1/2"	18"	33"	39"	19"	20 1/2"
OMC279024(N)	21"	21"	24"	25 1/2"	21"	24"	25 1/2"	18"	33"	39"	22"	23 1/2"
OMC309024(N)	21"	24"	27"	28 1/2"	24"	27"	28 1/2"	18"	33"	39"	22"	23 1/2"
OMC31.59024(N)	21"	25 1/2"	28 1/2"	30"	25 1/2"	28 1/2"	30"	18"	33"	39"	22"	23 1/2"
OMC339024(N)	21"	27"	30"	31 1/2"	27"	30"	31 1/2"	18"	33"	39"	22"	23 1/2"

Custom Modifications

ACS	ADDTK	AUTH	CBO	CCO	CFNTO	CFRMO	CH	CND	CW	DRT	DRWTK	DRWWRM	EXBK	EX	FB	FFD	FPEB	FTK	FTK_V	ID	INVFRM	MIP	RD	RECTK	RT	TD	TKP	VTK	
• ¹		•	•	•							• ²			•	•	•	•	•	•	•			•	•	•		•	•	•

Construction Upgrades

APC	ET	PE
•		•

Door Options

CG	CG.TOP	DPSRR	MFO
• ¹		•	•

¹ Only available on Narrow Stile (N) cabinets

² Not available on 27" wide

OVEN MICROWAVE CABINET, 93" or 96" TALL, 24" DEEP

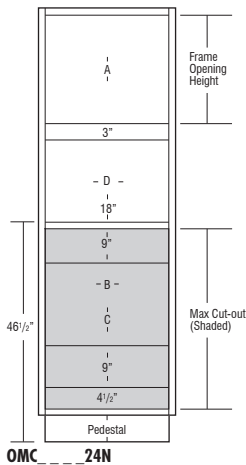
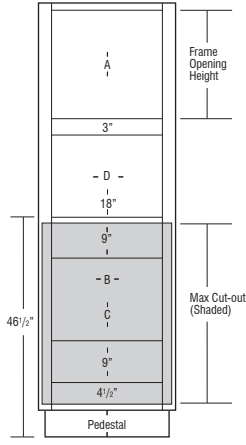
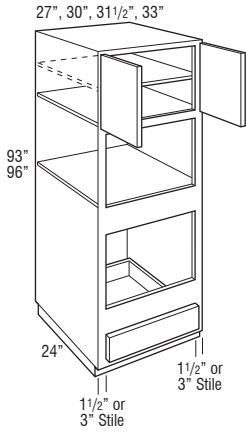

Price Point

	1	2	3	4	5	6	7	8	9	10	11	12
OMC279324(N)	3080	3312	3356	3398	3442	3484	3688	3825	3970	4107	4215	4557
OMC309324(N)	3244	3554	3642	3731	3819	3908	4135	4292	4454	4611	4730	5116
OMC31.59324(N)	3409	3731	3828	3924	4022	4118	4359	4524	4695	4862	4985	5394
OMC339324(N)	3575	3907	4013	4118	4224	4329	4582	4754	4936	5112	5240	5671
OMC279624(N)	3080	3312	3356	3398	3442	3484	3688	3825	3970	4107	4215	4557
OMC309624(N)	3244	3554	3642	3731	3819	3908	4135	4292	4454	4611	4730	5116
OMC31.59624(N)	3409	3731	3828	3924	4022	4118	4359	4524	4695	4862	4985	5394
OMC339624(N)	3575	3907	4013	4118	4224	4329	4582	4754	4936	5112	5240	5671

- N represents Narrow Stile cabinets with 1 1/2" wide face frame side stiles and ACS modification availability (see page 13 for ACS specifications). Doors and drawer fronts have a consistent width reveal for full overlay (1/4") and partial overlay (1") and use standard soft-close hinges.
- On cabinets with 3" wide face frame side stiles, doors use face mount hinges. Doors and drawer fronts have a consistent width reveal for full overlay (1/4") and partial overlay (1").
- Cabinets with 3" wide face frames are not available in certain door styles. See Door Style section for exceptions.
- Includes adjustable shelves in upper section:
93" tall - one shelf
96" tall - two shelves
- Designed for use with separate built-in microwave above, built-in oven below. For built-in double ovens, see pages 197-202.
- All top and bottom cross rails are 1 1/2" wide.
- All toe-kick areas are 4 1/2" high.
- Be sure to confirm a heat shield is built into your appliance by the manufacturer or install the heat shield included with your appliance. Heat shields are sold separately as an accessory.
- For built-in appliance support, OCINSTALLKIT is included in 24" deep oven cabinets (see page 313 for details). Oven install kit will not be included when depth is modified.
- OCINSTALLKIT weight limit is 400 lbs. per pair.
- Maximum w/Drawer cut-out dimension will allow 1/4" reveal for doors and drawer fronts on full overlay and 1" for partial overlay for trim kit face clearance.
- Oven cabinets feature an open back in cut-out area designed to improve field appliance installation.
- If the maximum height (as shown in gray) is cut out, the drawer will no longer be included. See chart below for maximum cut-out allowed if you want to keep the drawer.

	A Frame Opening Height	B/D Cut-out Width (standard)			B Cut-out Width (with ACS modification)			C Cut-out Height			Door Height (Upper Section)	
		Min.	Min. (N)	Max.	Min.	Max.	Max. w/ Field Cut	Min.	Max. Keeps Bottom Drawer	Max. Replaces Bottom Drawer	Partial Overlay	Full Overlay
OMC279324(N)	24"	21"	24"	25 1/2"	21"	24"	25 1/2"	18"	33"	39"	25"	26 1/2"
OMC309324(N)	24"	24"	27"	28 1/2"	24"	27"	28 1/2"	18"	33"	39"	25"	26 1/2"
OMC31.59324(N)	24"	25 1/2"	28 1/2"	30"	25 1/2"	28 1/2"	30"	18"	33"	39"	25"	26 1/2"
OMC339324(N)	24"	27"	30"	31 1/2"	27"	30"	31 1/2"	18"	33"	39"	25"	26 1/2"
OMC279624(N)	27"	21"	24"	25 1/2"	21"	24"	25 1/2"	18"	33"	39"	28"	29 1/2"
OMC309624(N)	27"	24"	27"	28 1/2"	24"	27"	28 1/2"	18"	33"	39"	28"	29 1/2"
OMC31.59624(N)	27"	25 1/2"	28 1/2"	30"	25 1/2"	28 1/2"	30"	18"	33"	39"	28"	29 1/2"
OMC339624(N)	27"	27"	30"	31 1/2"	27"	30"	31 1/2"	18"	33"	39"	28"	29 1/2"

Custom Modifications

ACS	ADTK	AUTH	CBO	CCO	CFNTO	CFRMO	CH	CND	CW	DRT	DRWTK	DRWWRM	EXBK	EX	FB	FFD	FPEB	FTK	FTK_V	ID	INFRM	MIP	RD	RECTK	RT	TD	TKP	VTK
• ¹											• ²																	

Construction Upgrades

APC	ET	PE
•		•

Door Options

CG	CG.TOP	DPSRR	MFO
• ¹		•	•

¹ Only available on Narrow Stile (N) cabinets
² Not available on 27" wide

**OVEN MICROWAVE CABINET,
DEEP DRAWER,
84", 87", or 90" TALL, 24" DEEP**

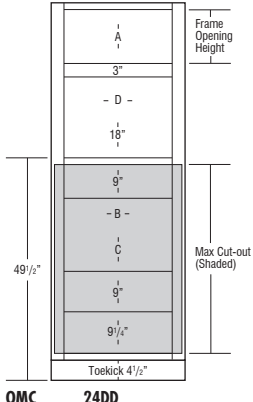
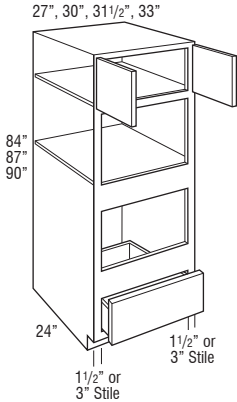

OMC_...24DD

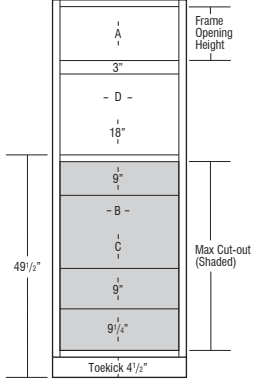

OMC_...24DDN

Price Point	1	2	3	4	5	6	7	8	9	10	11	12
OMC278424DD(N)	2340	2744	2787	2828	2871	2912	3067	3173	3282	3388	3468	3726
OMC308424DD(N)	2635	2899	3032	3165	3298	3432	3615	3740	3871	3992	4086	4388
OMC31.58424DD(N)	2798	3146	3269	3391	3513	3636	3826	3958	4095	4220	4319	4637
OMC338424DD(N)	2960	3394	3506	3616	3728	3839	4036	4175	4319	4449	4552	4884
OMC278724DD(N)	2620	2987	3039	3089	3139	3190	3362	3482	3606	3718	3809	4097
OMC308724DD(N)	2831	3304	3408	3512	3616	3721	3921	4057	4200	4333	4437	4767
OMC31.58724DD(N)	3054	3498	3611	3723	3835	3947	4154	4300	4450	4589	4698	5046
OMC338724DD(N)	3277	3692	3812	3932	4052	4172	4387	4542	4698	4843	4958	5324
OMC279024DD(N)	2899	3227	3288	3350	3412	3472	3660	3791	3928	4052	4150	4465
OMC309024DD(N)	3135	3560	3672	3784	3896	4008	4225	4375	4529	4673	4787	5150
OMC31.59024DD(N)	3366	3777	3896	4016	4136	4256	4482	4642	4805	4954	5076	5458
OMC339024DD(N)	3596	3992	4120	4248	4376	4504	4740	4909	5079	5235	5364	5766

- N represents Narrow Stile cabinets with 1 1/2" wide face frame side stiles and ACS modification availability (see page 13 for ACS specifications). Doors and drawer fronts have a consistent width reveal for full overlay (1/4") and partial overlay (1") and use standard soft-close hinges.
- On cabinets with 3" wide face frame side stiles, doors use face mount hinges. Doors and drawer fronts have a consistent width reveal for full overlay (1/4") and partial overlay (1").
- Designed for use with separate built-in microwave above, built-in oven below. For built-in double ovens, see pages 197-202.
- All top and bottom cross rails are 1 1/2" wide.
- All toe kick areas are 4 1/2" high.
- Be sure to confirm a heat shield is built into your appliance by the manufacturer or install the heat shield included with your appliance. Heat shields are sold separately as an accessory.
- For built-in appliance support, OCINSTALLKIT is included in 24" deep oven cabinets (see page 313 for details). Oven install kit will not be included when depth is modified.
- OCINSTALLKIT weight limit is 400 lbs. per pair.
- Maximum w/Drawer cut-out dimension will allow 1/4" reveal for doors and drawer fronts on full overlay and 1" for partial overlay for trim kit face clearance.
- Oven cabinets feature an open back in cut-out area designed to improve field appliance installation.
- If the maximum height (as shown in gray) is cut out, the drawer will no longer be included. See chart below for maximum cut-out allowed if you want to keep the drawer.

	A Frame Opening Height	B/D Cut-out Width (standard)			B Cut-out Width (with ACS modification)			C Cut-out Height			Door Height (Upper Section)	
		Min.	Min. (N)	Max.	Min.	Max.	Max. w/ Field Cut	Min.	Max. Keeps Bottom Drawer	Max. Replaces Bottom Drawer	Partial Overlay	Full Overlay
OMC278424DD(N)	12"	21"	24"	25 1/2"	21"	24"	25 1/2"	16 1/4"	31 1/4"	42"	13"	14 1/2"
OMC308424DD(N)	12"	24"	27"	28 1/2"	24"	27"	28 1/2"	16 1/4"	31 1/4"	42"	13"	14 1/2"
OMC31.58424DD(N)	12"	25 1/2"	28 1/2"	30"	25 1/2"	28 1/2"	30"	16 1/4"	31 1/4"	42"	13"	14 1/2"
OMC338424DD(N)	12"	27"	30"	31 1/2"	27"	30"	31 1/2"	16 1/4"	31 1/4"	42"	13"	14 1/2"
OMC278724DD(N)	15"	21"	24"	25 1/2"	21"	24"	25 1/2"	16 1/4"	31 1/4"	42"	16"	17 1/2"
OMC308724DD(N)	15"	24"	27"	28 1/2"	24"	27"	28 1/2"	16 1/4"	31 1/4"	42"	16"	17 1/2"
OMC31.58724DD(N)	15"	25 1/2"	28 1/2"	30"	25 1/2"	28 1/2"	30"	16 1/4"	31 1/4"	42"	16"	17 1/2"
OMC338724DD(N)	15"	27"	30"	31 1/2"	27"	30"	31 1/2"	16 1/4"	31 1/4"	42"	16"	17 1/2"
OMC279024DD(N)	18"	21"	24"	25 1/2"	21"	24"	25 1/2"	16 1/4"	31 1/4"	42"	19"	20 1/2"
OMC309024DD(N)	18"	24"	27"	28 1/2"	24"	27"	28 1/2"	16 1/4"	31 1/4"	42"	19"	20 1/2"
OMC31.59024DD(N)	18"	25 1/2"	28 1/2"	30"	25 1/2"	28 1/2"	30"	16 1/4"	31 1/4"	42"	19"	20 1/2"
OMC339024DD(N)	18"	27"	30"	31 1/2"	27"	30"	31 1/2"	16 1/4"	31 1/4"	42"	19"	20 1/2"

Custom Modifications

ACS	ADDTK	AUTH	CBO	CCO	CFNTO	CFRMO	CH	CND	CW	DRT	DRWTK	DRWWRM	EXBK	EX	FB	FFD	FPEB	FTK	FTK_V	ID	INVFRM	MIP	RD	RECTK	RT	TD	TKP	VTK		
• ¹	•	•	•	•	•	•	•	•	•	• ²	•	•	•	•	•	•	•	•	•	•	•	•	•	•	•	•	•	•	•	• ³

Construction Upgrades

APC	ET	PE
•	•	•

Door Options

CG	CG.TOP	DPSRR	MFO
• ¹	•	•	•

¹ Only available on Narrow Stile (N) cabinets
² Not available on 27" wide
³ Not available on 84" tall

**OVEN MICROWAVE CABINET,
DEEP DRAWER,
93" or 96" TALL, 24" DEEP**

27", 30", 31 1/2", 33"

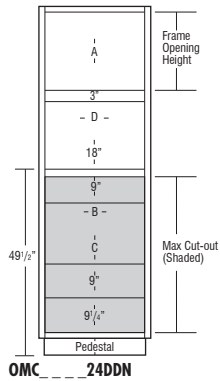
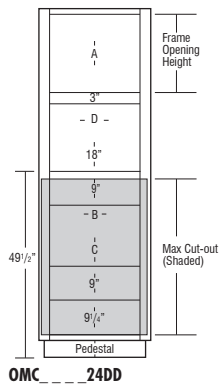
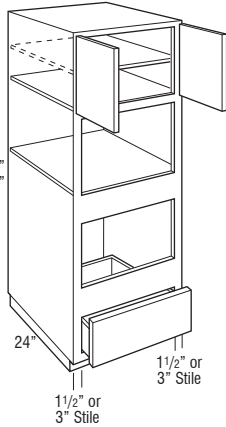

Price Point

	1	2	3	4	5	6	7	8	9	10	11	12
OMC279324DD(N)	3465	3722	3799	3876	3954	4030	4250	4404	4565	4711	4829	5202
OMC309324DD(N)	3135	3560	3672	3784	3896	4008	4225	4375	4529	4673	4787	5150
OMC31.59324DD(N)	3366	3777	3896	4016	4136	4256	4482	4642	4805	4954	5076	5458
OMC339324DD(N)	3596	3992	4120	4248	4376	4504	4740	4909	5079	5235	5364	5766
OMC279624DD(N)	3465	3722	3799	3876	3954	4030	4250	4404	4565	4711	4829	5202
OMC309624DD(N)	3739	4079	4207	4333	4460	4586	4835	5010	5190	5358	5488	5910
OMC31.59624DD(N)	3985	4334	4471	4607	4742	4878	5141	5326	5516	5694	5831	6276
OMC339624DD(N)	4231	4590	4735	4880	5024	5169	5447	5641	5842	6029	6172	6642

- N represents Narrow Stile cabinets with 1 1/2" wide face frame side stiles and ACS modification availability (see page 13 for ACS specifications). Doors and drawer fronts have a consistent width reveal for full overlay (1/4") and partial overlay (1") and use standard soft-close hinges.
- On cabinets with 3" wide face frame side stiles, doors use face mount hinges. Doors and drawer fronts have a consistent width reveal for full overlay (1/4") and partial overlay (1").
- Designed for use with separate built-in microwave above, built-in oven below. For built-in double ovens, see pages 197-202.
- All top and bottom cross rails are 1 1/2" wide.
- All toe kick areas are 4 1/2" high.
- Be sure to confirm a heat shield is built into your appliance by the manufacturer or install the heat shield included with your appliance. Heat shields are sold separately as an accessory.
- One full depth adjustable shelf included, but packaged separately.
- For built-in appliance support, OCINSTALKIT is included in 24" deep oven cabinets (see page 313 for details). Oven install kit will not be included when depth is modified.
- OCINSTALKIT weight limit is 400 lbs. per pair.
- Maximum w/Drawer cut-out dimension will allow 1/4" reveal for doors and drawer fronts on full overlay and 1" for partial overlay for trim kit face clearance.
- Oven cabinets feature an open back in cut-out area designed to improve field appliance installation.
- If the maximum height (as shown in gray) is cut out, the drawer will no longer be included. See chart below for maximum cut-out allowed if you want to keep the drawer.

	A Frame Opening Height	B/D Cut-out Width (standard)			B Cut-out Width (with ACS modification)			C Cut-out Height			Door Height (Upper Section)	
		Min.	Min. (N)	Max.	Min.	Max.	Max. w/ Field Cut	Min.	Max. Keeps Bottom Drawer	Max. Replaces Bottom Drawer	Partial Overlay	Full Overlay
OMC279324DD(N)	21"	21"	24"	25 1/2"	21"	24"	25 1/2"	16 1/4"	31 1/4"	42"	22"	23 1/2"
OMC309324DD(N)	21"	24"	27"	28 1/2"	24"	27"	28 1/2"	16 1/4"	31 1/4"	42"	22"	23 1/2"
OMC31.59324DD(N)	21"	25 1/2"	28 1/2"	30"	25 1/2"	28 1/2"	30"	16 1/4"	31 1/4"	42"	22"	23 1/2"
OMC339324DD(N)	21"	27"	30"	31 1/2"	27"	30"	31 1/2"	16 1/4"	31 1/4"	42"	22"	23 1/2"
OMC279624DD(N)	24"	21"	24"	25 1/2"	21"	24"	25 1/2"	16 1/4"	31 1/4"	42"	25"	26 1/2"
OMC309624DD(N)	24"	24"	27"	28 1/2"	24"	27"	28 1/2"	16 1/4"	31 1/4"	42"	25"	26 1/2"
OMC31.59624DD(N)	24"	25 1/2"	28 1/2"	30"	25 1/2"	28 1/2"	30"	16 1/4"	31 1/4"	42"	25"	26 1/2"
OMC339624DD(N)	24"	27"	30"	31 1/2"	27"	30"	31 1/2"	16 1/4"	31 1/4"	42"	25"	26 1/2"

Custom Modifications

ACS	ADDTK	AUTH	CBO	CCO	CFNTO	CFRMO	CH	CND	CW	DRT	DRWTK	DRWWRM	EXBK	EX	FB	FFD	FPEB	FTK	FTK_V	ID	INFRM	MIP	RD	RECTK_	RT	TD	TKP	VTK
• ¹																												

Construction Upgrades

APC	ET	PE
•		

Door Options

CG	CG.TOP	DPSRR	MFO
• ¹			

¹ Only available on Narrow Stile (N) cabinets

² Not available on 27" wide

TABLE OF CONTENTS – OFFICE & FURNITURE CABINETS

Bookcase Cabinets212
Wall Furniture Bookcase Cabinets214
Tall Bookcase Cabinets216
Desk Base Cabinets220
Desk Three Drawer Base Cabinets221
Desk Organization and Specialty Cabinets221
Furniture Drawers222
Wood Tops223
Under Counter Drawers225

OFFICE & FURNITURE CABINETS

OFFICE & FURNITURE CABINET NOMENCLATURE

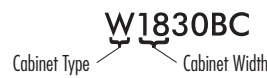

MODIFICATIONS GRID KEY

- Available
- STD Standard on these cabinets

CONSTRUCTION UPGRADES

Mod.	Description
APC	All-plywood Construction
PE	Plywood Ends

DOOR OPTIONS

Mod.	Description
DPSRR	Door Panel - Solid Reverse Raised

CUSTOM MODIFICATIONS

Mod.	Description	Mod.	Description
ADDTK	Add Toekick	FFDR	Face Frame and Door on End - Right
AUTHB	Authentic Ends - Both	FPEB	Furniture Finished Plywood Ends
AUTHL	Authentic End - Left	FTK	Flush Toekick
AUTHR	Authentic End - Right	FTKAV	Flush Toekick Arch
CBO	Cabinet Box Only	FTKRV	Flush Toekick Furniture
CCO	Cabinet Case Only	ID	Increased Depth
CFNTO	Cabinet Front Only	INVFRM	Inverted Frame
CFP	Cabinet False Panel	MIP	Matching Interior Plywood
CFRMO	Cabinet Frame Only	PFINBTMB	Prepare Cabinet for Finished Bottom
CH	Custom Height	PTOWB	Push to Open Wastebasket
CND	Cabinet with No Door, with Drawer	RD	Reduced Depth
CW	Custom Width	RECTKALL	Recessed Island Toekick
DRWPWR	PowerGlide™ Compact Drawer Outlet	RECTKBK	Recessed Toekick - Back
DRWSEC	Biometric Secured Drawer	RECTKL	Recessed Toekick - Left
DRWTK	Toekick Drawer	RECTKR	Recessed Toekick - Right
EXBKL	End Extended Back - Left	RT	Installed Roll Tray
EXBKR	End Extended Back - Right	TVRAV	Valance Top Rail, Arch
EXL	Extended Stile - Left	TVRFV	Valance Top Rail, Furniture
EXR	Extended Stile - Right	TVRVV	Valance Top Rail, Straight
FB	Finished Ends	VTK	Void Toekick
FFDL	Face Frame and Door on End - Left		

Standard toekick height is 4 1/2" tall, which will align with standard base cabinets.

All office cabinets are predrilled for full depth shelves or roll trays.

**BOOKCASE, 30", 33", or 36" HIGH,
12" DEEP**

18", 21", 24", 27",
30", 33", or 36"

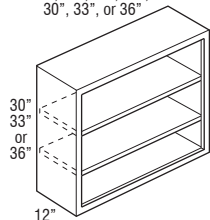

Price
Point

	1	2	3	4	5	6	7	8	9	10	11	12
W1830BC	1040	1040	1040	1040	1040	1040	1040	1040	1040	1040	1040	1040
W2130BC	1084	1084	1084	1084	1084	1084	1084	1084	1084	1084	1084	1084
W2430BC	1128	1128	1128	1128	1128	1128	1128	1128	1128	1128	1128	1128
W2730BC	1188	1188	1188	1188	1188	1188	1188	1188	1188	1188	1188	1188
W3030BC	1250	1250	1250	1250	1250	1250	1250	1250	1250	1250	1250	1250
W3330BC	1288	1288	1288	1288	1288	1288	1288	1288	1288	1288	1288	1288
W3630BC	1325	1325	1325	1325	1325	1325	1325	1325	1325	1325	1325	1325
W1833BC	1091	1091	1091	1091	1091	1091	1091	1091	1091	1091	1091	1091
W2133BC	1138	1138	1138	1138	1138	1138	1138	1138	1138	1138	1138	1138
W2433BC	1184	1184	1184	1184	1184	1184	1184	1184	1184	1184	1184	1184
W2733BC	1247	1247	1247	1247	1247	1247	1247	1247	1247	1247	1247	1247
W3033BC	1312	1312	1312	1312	1312	1312	1312	1312	1312	1312	1312	1312
W3333BC	1352	1352	1352	1352	1352	1352	1352	1352	1352	1352	1352	1352
W3633BC	1392	1392	1392	1392	1392	1392	1392	1392	1392	1392	1392	1392
W1836BC	1142	1142	1142	1142	1142	1142	1142	1142	1142	1142	1142	1142
W2136BC	1191	1191	1191	1191	1191	1191	1191	1191	1191	1191	1191	1191
W2436BC	1240	1240	1240	1240	1240	1240	1240	1240	1240	1240	1240	1240
W2736BC	1306	1306	1306	1306	1306	1306	1306	1306	1306	1306	1306	1306
W3036BC	1374	1374	1374	1374	1374	1374	1374	1374	1374	1374	1374	1374
W3336BC	1416	1416	1416	1416	1416	1416	1416	1416	1416	1416	1416	1416
W3636BC	1458	1458	1458	1458	1458	1458	1458	1458	1458	1458	1458	1458

- If ordered with Heirloom Technique, will not feature sand-through characteristics.
- To change the top rail valance, specify one of the following modifications: Arch (TVRAV), Furniture (TVRFV), or Straight Valance (TVRVV).

Custom Modifications

ADDTK	AUTH	CBO	CCO	CFNTD	CFP	CFRMO	CH	CND	CW	DRWPWR	DRWSEC	DRWTK	EXBK	EX	FB	FFD	FPEB	FTK	FTK_V	ID	INVFRM	MIP	PFINBTMB	PTOWB	RD	RECTK	RT	TVR_V	VTK
•	•	•	•	•	•	•	•	•	•	•	•	•	•	•	•	•	•	•	•	•	•	•	•	•	•	•	•	•	•

Construction Upgrades

APC	PE
-----	----

Door Options

DPSRR

¹ Minimum height is 24" for 30" high, 30 1/4" for 33" high, and 33 1/4" for 36" high

BOOKCASE, 39", 42", or 48" HIGH, 12" DEEP

18", 21", 24", 27", 30", 33", or 36"

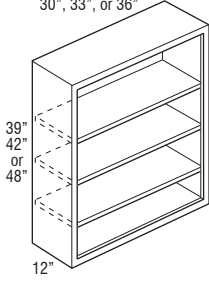

Price Point

	1	2	3	4	5	6	7	8	9	10	11	12
W1839BC	1194	1194	1194	1194	1194	1194	1194	1194	1194	1194	1194	1194
W2139BC	1245	1245	1245	1245	1245	1245	1245	1245	1245	1245	1245	1245
W2439BC	1295	1295	1295	1295	1295	1295	1295	1295	1295	1295	1295	1295
W2739BC	1365	1365	1365	1365	1365	1365	1365	1365	1365	1365	1365	1365
W3039BC	1436	1436	1436	1436	1436	1436	1436	1436	1436	1436	1436	1436
W3339BC	1480	1480	1480	1480	1480	1480	1480	1480	1480	1480	1480	1480
W3639BC	1525	1525	1525	1525	1525	1525	1525	1525	1525	1525	1525	1525
W1842BC	1245	1245	1245	1245	1245	1245	1245	1245	1245	1245	1245	1245
W2142BC	1298	1298	1298	1298	1298	1298	1298	1298	1298	1298	1298	1298
W2442BC	1351	1351	1351	1351	1351	1351	1351	1351	1351	1351	1351	1351
W2742BC	1424	1424	1424	1424	1424	1424	1424	1424	1424	1424	1424	1424
W3042BC	1498	1498	1498	1498	1498	1498	1498	1498	1498	1498	1498	1498
W3342BC	1544	1544	1544	1544	1544	1544	1544	1544	1544	1544	1544	1544
W3642BC	1591	1591	1591	1591	1591	1591	1591	1591	1591	1591	1591	1591
W1848BC	1296	1296	1296	1296	1296	1296	1296	1296	1296	1296	1296	1296
W2148BC	1352	1352	1352	1352	1352	1352	1352	1352	1352	1352	1352	1352
W2448BC	1407	1407	1407	1407	1407	1407	1407	1407	1407	1407	1407	1407
W2748BC	1483	1483	1483	1483	1483	1483	1483	1483	1483	1483	1483	1483
W3048BC	1560	1560	1560	1560	1560	1560	1560	1560	1560	1560	1560	1560
W3348BC	1608	1608	1608	1608	1608	1608	1608	1608	1608	1608	1608	1608
W3648BC	1658	1658	1658	1658	1658	1658	1658	1658	1658	1658	1658	1658

213

- If ordered with Heirloom Technique, will not feature sand-through characteristics.
- To change the top rail valance, specify one of the following modifications: Arch (TVRAV), Furniture (TVRFV), or Straight Valance (TVRVV).

Custom Modifications

ADTK	AUTH	CBO	CCO	CFNT0	CFP	CFRMO	CH	CND	CW	DRWPWR	DRWSEC	DRWTK	EXBK	EX	FB	FFD	FPFB	FTK	FTK_V	ID	INVERM	MIP	PFINBTMB	PTOWB	RD	RECTK	RT	TVR_V	VTX
•	•	STD					•	• ¹	•				•	•			•						STD	•					•

Construction Upgrades

APC	PE
-----	----

Door Options

DPSRR

¹ Minimum height is 36 1/4" for 39" high, 39 1/4" for 42" high, and 42 1/4" for 48" high

**WALL FURNITURE BOOKCASE,
48", 51", or 54" HIGH, 12" DEEP**

18", 21", 24", 27",
30", 33", or 36"

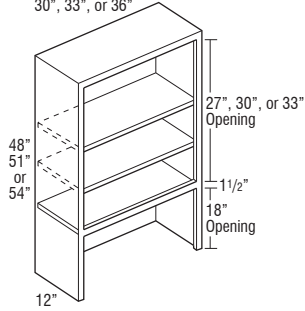

Price
Point

	1	2	3	4	5	6	7	8	9	10	11	12
WFBC1848	1355	1355	1355	1355	1355	1355	1355	1355	1355	1355	1355	1355
WFBC2148	1411	1411	1411	1411	1411	1411	1411	1411	1411	1411	1411	1411
WFBC2448	1465	1465	1465	1465	1465	1465	1465	1465	1465	1465	1465	1465
WFBC2748	1539	1539	1539	1539	1539	1539	1539	1539	1539	1539	1539	1539
WFBC3048	1613	1613	1613	1613	1613	1613	1613	1613	1613	1613	1613	1613
WFBC3348	1661	1661	1661	1661	1661	1661	1661	1661	1661	1661	1661	1661
WFBC3648	1710	1710	1710	1710	1710	1710	1710	1710	1710	1710	1710	1710
WFBC1851	1409	1409	1409	1409	1409	1409	1409	1409	1409	1409	1409	1409
WFBC2151	1465	1465	1465	1465	1465	1465	1465	1465	1465	1465	1465	1465
WFBC2451	1521	1521	1521	1521	1521	1521	1521	1521	1521	1521	1521	1521
WFBC2751	1598	1598	1598	1598	1598	1598	1598	1598	1598	1598	1598	1598
WFBC3051	1674	1674	1674	1674	1674	1674	1674	1674	1674	1674	1674	1674
WFBC3351	1724	1724	1724	1724	1724	1724	1724	1724	1724	1724	1724	1724
WFBC3651	1773	1773	1773	1773	1773	1773	1773	1773	1773	1773	1773	1773
WFBC1854	1462	1462	1462	1462	1462	1462	1462	1462	1462	1462	1462	1462
WFBC2154	1518	1518	1518	1518	1518	1518	1518	1518	1518	1518	1518	1518
WFBC2454	1574	1574	1574	1574	1574	1574	1574	1574	1574	1574	1574	1574
WFBC2754	1654	1654	1654	1654	1654	1654	1654	1654	1654	1654	1654	1654
WFBC3054	1733	1733	1733	1733	1733	1733	1733	1733	1733	1733	1733	1733
WFBC3354	1785	1785	1785	1785	1785	1785	1785	1785	1785	1785	1785	1785
WFBC3654	1837	1837	1837	1837	1837	1837	1837	1837	1837	1837	1837	1837

- 48", 51", and 54" have two adjustable shelves and one fixed shelf.
- If ordered with Heirloom Technique, will not feature sand-through characteristics.
- To change the top rail valance, specify one of the following modifications: Arch (TVRAV), Furniture (TVRFV), or Straight Valance (TVRVV).
- Bookcases can only be reduced to 9".

Custom Modifications

ADDTK	AUTH	CBO	CCO	CFNTO	CFP	CFRMO	CH	CND	CW	DRWPPWR	DRWSEC	DRWTK	EXBK	EX	FB	FFD	FPEB	FTK	FTK_V	ID	INVFRM	MIP	PFINBTMB	PTOWB	RD	RECTK	RT	TVR_V	VTK

Construction Upgrades

APC	PE

Door Options

DPSRR

¹ Minimum height is 42"

**WALL FURNITURE BOOKCASE,
57", 60", or 66" HIGH, 12" DEEP**

18", 21", 24", 27",
30", 33", or 36"

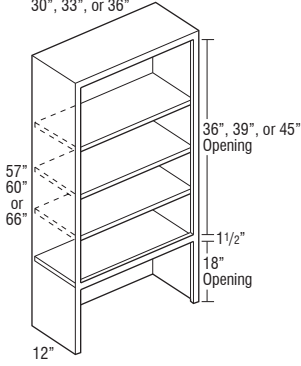

Price
Point

	1	2	3	4	5	6	7	8	9	10	11	12
WFBC1857	1605	1605	1605	1605	1605	1605	1605	1605	1605	1605	1605	1605
WFBC2157	1669	1669	1669	1669	1669	1669	1669	1669	1669	1669	1669	1669
WFBC2457	1732	1732	1732	1732	1732	1732	1732	1732	1732	1732	1732	1732
WFBC2757	1818	1818	1818	1818	1818	1818	1818	1818	1818	1818	1818	1818
WFBC3057	1904	1904	1904	1904	1904	1904	1904	1904	1904	1904	1904	1904
WFBC3357	1962	1962	1962	1962	1962	1962	1962	1962	1962	1962	1962	1962
WFBC3657	2019	2019	2019	2019	2019	2019	2019	2019	2019	2019	2019	2019
WFBC1860	1622	1622	1622	1622	1622	1622	1622	1622	1622	1622	1622	1622
WFBC2160	1687	1687	1687	1687	1687	1687	1687	1687	1687	1687	1687	1687
WFBC2460	1752	1752	1752	1752	1752	1752	1752	1752	1752	1752	1752	1752
WFBC2760	1840	1840	1840	1840	1840	1840	1840	1840	1840	1840	1840	1840
WFBC3060	1928	1928	1928	1928	1928	1928	1928	1928	1928	1928	1928	1928
WFBC3360	1986	1986	1986	1986	1986	1986	1986	1986	1986	1986	1986	1986
WFBC3660	2043	2043	2043	2043	2043	2043	2043	2043	2043	2043	2043	2043
WFBC1866	1783	1783	1783	1783	1783	1783	1783	1783	1783	1783	1783	1783
WFBC2166	1856	1856	1856	1856	1856	1856	1856	1856	1856	1856	1856	1856
WFBC2466	1929	1929	1929	1929	1929	1929	1929	1929	1929	1929	1929	1929
WFBC2766	2024	2024	2024	2024	2024	2024	2024	2024	2024	2024	2024	2024
WFBC3066	2118	2118	2118	2118	2118	2118	2118	2118	2118	2118	2118	2118
WFBC3366	2184	2184	2184	2184	2184	2184	2184	2184	2184	2184	2184	2184
WFBC3666	2249	2249	2249	2249	2249	2249	2249	2249	2249	2249	2249	2249

215

- 57", 60", and 66" have three adjustable shelves and one fixed shelf.
- If ordered with Heirloom Technique, will not feature sand-through characteristics.
- To change the top rail valance, specify one of the following modifications: Arch (TVRAV), Furniture (TVRFV), or Straight Valance (TVRVV).
- Bookcases can only be reduced to 9".

Custom Modifications

ADDTK	AUTH	CBO	CCO	CFNTD	CFP	CFRMO	CH	CND	CW	DRWPWR	DRWSEC	DRWTK	EXBK	EX	FB	FFD	FPFB	FTK	FTK_V	ID	INFRM	MIP	PFINBTMB	PTOWB	RD	RECTK	RT	TVR_V	VTX	

Construction Upgrades

APC	PE
-----	----

Door Options

DPSRR

¹ Not available on 66" high

TALL BOOKCASE, 84", 87", or 90" HIGH, 12" or 18" DEEP

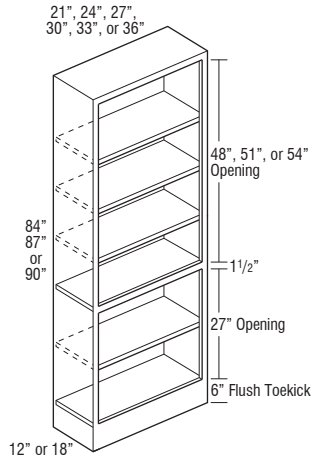

Price Point	1	2	3	4	5	6	7	8	9	10	11	12
TBC218412	2729	2729	2729	2729	2729	2729	2729	2729	2729	2729	2729	2729
TBC248412	2855	2855	2855	2855	2855	2855	2855	2855	2855	2855	2855	2855
TBC278412	3009	3009	3009	3009	3009	3009	3009	3009	3009	3009	3009	3009
TBC308412	3163	3163	3163	3163	3163	3163	3163	3163	3163	3163	3163	3163
TBC338412	3259	3259	3259	3259	3259	3259	3259	3259	3259	3259	3259	3259
TBC368412	3357	3357	3357	3357	3357	3357	3357	3357	3357	3357	3357	3357
TBC218418	3274	3274	3274	3274	3274	3274	3274	3274	3274	3274	3274	3274
TBC248418	3425	3425	3425	3425	3425	3425	3425	3425	3425	3425	3425	3425
TBC278418	3611	3611	3611	3611	3611	3611	3611	3611	3611	3611	3611	3611
TBC308418	3797	3797	3797	3797	3797	3797	3797	3797	3797	3797	3797	3797
TBC338418	3912	3912	3912	3912	3912	3912	3912	3912	3912	3912	3912	3912
TBC368418	4028	4028	4028	4028	4028	4028	4028	4028	4028	4028	4028	4028
TBC218712	2781	2781	2781	2781	2781	2781	2781	2781	2781	2781	2781	2781
TBC248712	2906	2906	2906	2906	2906	2906	2906	2906	2906	2906	2906	2906
TBC278712	3062	3062	3062	3062	3062	3062	3062	3062	3062	3062	3062	3062
TBC308712	3219	3219	3219	3219	3219	3219	3219	3219	3219	3219	3219	3219
TBC338712	3316	3316	3316	3316	3316	3316	3316	3316	3316	3316	3316	3316
TBC368712	3414	3414	3414	3414	3414	3414	3414	3414	3414	3414	3414	3414
TBC218718	3332	3332	3332	3332	3332	3332	3332	3332	3332	3332	3332	3332
TBC248718	3484	3484	3484	3484	3484	3484	3484	3484	3484	3484	3484	3484
TBC278718	3675	3675	3675	3675	3675	3675	3675	3675	3675	3675	3675	3675
TBC308718	3864	3864	3864	3864	3864	3864	3864	3864	3864	3864	3864	3864
TBC338718	3980	3980	3980	3980	3980	3980	3980	3980	3980	3980	3980	3980
TBC368718	4097	4097	4097	4097	4097	4097	4097	4097	4097	4097	4097	4097
TBC219012	2829	2829	2829	2829	2829	2829	2829	2829	2829	2829	2829	2829
TBC249012	2957	2957	2957	2957	2957	2957	2957	2957	2957	2957	2957	2957
TBC279012	3116	3116	3116	3116	3116	3116	3116	3116	3116	3116	3116	3116
TBC309012	3274	3274	3274	3274	3274	3274	3274	3274	3274	3274	3274	3274
TBC339012	3373	3373	3373	3373	3373	3373	3373	3373	3373	3373	3373	3373
TBC369012	3472	3472	3472	3472	3472	3472	3472	3472	3472	3472	3472	3472
TBC219018	3390	3390	3390	3390	3390	3390	3390	3390	3390	3390	3390	3390
TBC249018	3545	3545	3545	3545	3545	3545	3545	3545	3545	3545	3545	3545
TBC279018	3739	3739	3739	3739	3739	3739	3739	3739	3739	3739	3739	3739
TBC309018	3931	3931	3931	3931	3931	3931	3931	3931	3931	3931	3931	3931
TBC339018	4049	4049	4049	4049	4049	4049	4049	4049	4049	4049	4049	4049
TBC369018	4166	4166	4166	4166	4166	4166	4166	4166	4166	4166	4166	4166

- 84" and 87" tall include four adjustable shelves and one fixed shelf.
- 90" tall includes five adjustable shelves and one fixed shelf.
- If ordered with Heirloom Technique, will not feature sand-through characteristics.
- To change the top rail valance, specify one of the following modifications: Arch (TVRAV), Furniture (TVRFV), or Straight Valance (TVRVV).
- Bookcases can only be reduced to 9".

Custom Modifications

ADDTK	AUTH	CBO	CCO	CFNT0	CFP	CFRMO	CH	CND	CW	DRWPWR	DRWSEC	DRWTK	EXBK	EX	FB	FFD	FPEB	FTK	FTK_V	ID	INVFRM	MIP	PFINBTMB	PTOWB	RD	RECTK	RT	TVR_V	VTK	

Construction Upgrades

APC	PE

Door Options

DPSRR

¹ Minimum height is 69 1/4"

**TALL BOOKCASE, 93" or 96" HIGH,
12" or 18" DEEP**

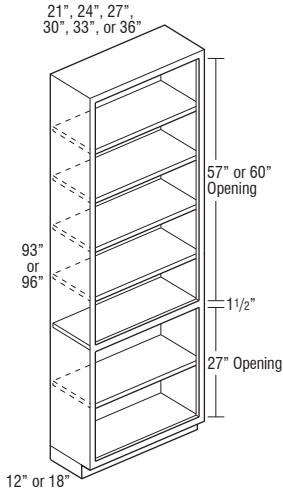

	Price Point	1	2	3	4	5	6	7	8	9	10	11	12
TBC219312		2918	2918	2918	2918	2918	2918	2918	2918	2918	2918	2918	2918
TBC249312		3050	3050	3050	3050	3050	3050	3050	3050	3050	3050	3050	3050
TBC279312		3214	3214	3214	3214	3214	3214	3214	3214	3214	3214	3214	3214
TBC309312		3378	3378	3378	3378	3378	3378	3378	3378	3378	3378	3378	3378
TBC339312		3481	3481	3481	3481	3481	3481	3481	3481	3481	3481	3481	3481
TBC369312		3583	3583	3583	3583	3583	3583	3583	3583	3583	3583	3583	3583
TBC219318		3497	3497	3497	3497	3497	3497	3497	3497	3497	3497	3497	3497
TBC249318		3658	3658	3658	3658	3658	3658	3658	3658	3658	3658	3658	3658
TBC279318		3857	3857	3857	3857	3857	3857	3857	3857	3857	3857	3857	3857
TBC309318		4058	4058	4058	4058	4058	4058	4058	4058	4058	4058	4058	4058
TBC339318		4180	4180	4180	4180	4180	4180	4180	4180	4180	4180	4180	4180
TBC369318		4301	4301	4301	4301	4301	4301	4301	4301	4301	4301	4301	4301
TBC219612		2918	2918	2918	2918	2918	2918	2918	2918	2918	2918	2918	2918
TBC249612		3050	3050	3050	3050	3050	3050	3050	3050	3050	3050	3050	3050
TBC279612		3214	3214	3214	3214	3214	3214	3214	3214	3214	3214	3214	3214
TBC309612		3378	3378	3378	3378	3378	3378	3378	3378	3378	3378	3378	3378
TBC339612		3481	3481	3481	3481	3481	3481	3481	3481	3481	3481	3481	3481
TBC369612		3583	3583	3583	3583	3583	3583	3583	3583	3583	3583	3583	3583
TBC219618		3497	3497	3497	3497	3497	3497	3497	3497	3497	3497	3497	3497
TBC249618		3658	3658	3658	3658	3658	3658	3658	3658	3658	3658	3658	3658
TBC279618		3857	3857	3857	3857	3857	3857	3857	3857	3857	3857	3857	3857
TBC309618		4058	4058	4058	4058	4058	4058	4058	4058	4058	4058	4058	4058
TBC339618		4180	4180	4180	4180	4180	4180	4180	4180	4180	4180	4180	4180
TBC369618		4301	4301	4301	4301	4301	4301	4301	4301	4301	4301	4301	4301

- 93" tall includes five adjustable shelves and one fixed shelf.
- 96" tall includes six adjustable shelves and one fixed shelf.
- Separate pedestal base included but packaged separately on 93" and 96" tall. Pedestals are the same width as the cabinet box except when specified with FPEB, in which the pedestal will be 1/4" recessed when centered.
- If ordered with Heirloom Technique, will not feature sand-through characteristics.
- To change the top rail valance, specify one of the following modifications: Arch (TVRAV), Furniture (TVRFV), or Straight Valance (TVRVV).
- Bookcases can only be reduced to 9".

Custom Modifications

ADDTK	AUTH	CBO	CCO	CFNT0	CFP	CFRMO	CH	CND	CW	DRWPWR	DRWSEC	DRWTK	EXBK	EX	FB	FFD	FPEB	FTK	FTK_V	ID	INVFRM	MIP	PFINBTMB	PTOWB	RD	RECTK	RT	TVR_V	VTK	

Construction Upgrades

APC	PE
-----	----

Door Options

DPSRR

TALL BOOKCASE with DOORS, 84", 87", or 90" HIGH, 12" or 18" DEEP

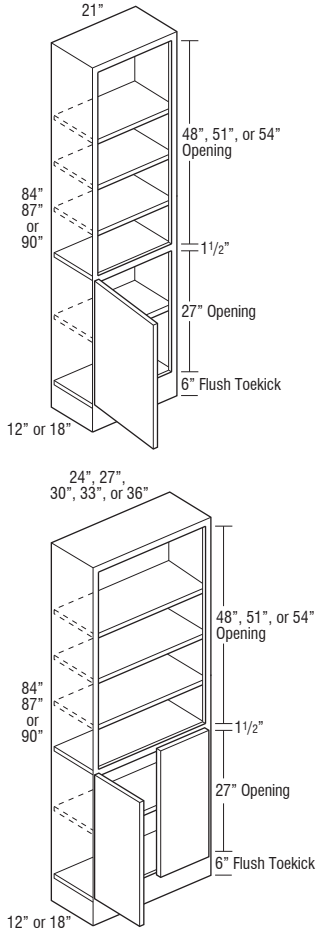

Price Point	1	2	3	4	5	6	7	8	9	10	11	12
TBCD218412 L or R	3226	3273	3304	3334	3366	3396	3602	3742	3772	3802	4007	4048
TBCD218418 L or R	3776	3832	3867	3903	3939	3974	4216	4380	4416	4451	4692	4739
TBCD218712 L or R	3284	3331	3362	3392	3424	3454	3665	3808	3839	3870	4078	4119
TBCD218718 L or R	3840	3898	3935	3970	4006	4042	4288	4455	4492	4528	4771	4819
TBCD219012 L or R	3339	3388	3419	3451	3482	3513	3727	3873	3905	3937	4148	4190
TBCD219018 L or R	3908	3964	4002	4039	4076	4113	4361	4532	4570	4607	4854	4903
TBCD248412	3352	3401	3434	3465	3497	3528	3743	3889	3921	3952	4123	4207
TBCD278412	3426	3478	3538	3599	3659	3718	3945	4098	4126	4153	4377	4421
TBCD308412	3499	3553	3642	3731	3820	3909	4147	4308	4331	4355	4542	4635
TBCD338412	3577	3631	3721	3809	3899	3987	4229	4394	4413	4432	4664	4711
TBCD368412	3655	3709	3798	3886	3975	4063	4310	4479	4495	4510	4689	4785
TBCD248418	3924	3975	4016	4057	4097	4137	4389	4558	4586	4613	4795	4892
TBCD278418	4029	4081	4152	4221	4291	4360	4624	4804	4826	4847	5092	5143
TBCD308418	4133	4187	4286	4385	4483	4582	4860	5049	5065	5080	5285	5393
TBCD338418	4231	4284	4383	4481	4580	4678	4963	5158	5170	5181	5434	5489
TBCD368418	4328	4381	4480	4579	4677	4775	5066	5264	5273	5281	5475	5587
TBCD248712	3412	3461	3493	3525	3557	3588	3809	3959	3991	4021	4198	4283
TBCD278712	3484	3538	3600	3661	3723	3783	4015	4171	4199	4227	4455	4500
TBCD308712	3558	3614	3705	3796	3886	3977	4220	4383	4408	4433	4621	4715
TBCD338712	3639	3695	3786	3876	3967	4057	4304	4469	4491	4512	4744	4792
TBCD368712	3720	3774	3865	3955	4045	4135	4386	4554	4572	4590	4771	4869
TBCD248718	3994	4045	4088	4129	4171	4212	4465	4639	4667	4694	4879	4978
TBCD278718	4099	4152	4224	4295	4367	4437	4705	4889	4911	4932	5180	5233
TBCD308718	4204	4259	4360	4461	4562	4661	4944	5139	5154	5169	5375	5485
TBCD338718	4304	4359	4460	4561	4661	4761	5050	5247	5261	5273	5529	5585
TBCD368718	4404	4456	4557	4658	4759	4860	5155	5357	5366	5375	5571	5685
TBCD249012	3470	3520	3554	3586	3620	3652	3877	4025	4059	4091	4269	4357
TBCD279012	3544	3599	3661	3724	3787	3849	4086	4243	4272	4300	4533	4579
TBCD309012	3618	3676	3769	3861	3954	4045	4293	4460	4483	4507	4703	4799
TBCD339012	3700	3756	3849	3941	4034	4126	4378	4547	4568	4589	4826	4875
TBCD369012	3782	3837	3929	4021	4113	4204	4461	4633	4651	4668	4853	4952
TBCD249018	4063	4113	4155	4198	4240	4283	4543	4719	4745	4772	4962	5062
TBCD279018	4171	4222	4295	4368	4441	4514	4786	4973	4994	5015	5268	5322
TBCD309018	4277	4331	4434	4537	4640	4743	5029	5227	5243	5258	5469	5581
TBCD339018	4379	4434	4537	4639	4741	4843	5136	5339	5351	5364	5625	5682
TBCD369018	4480	4536	4638	4739	4841	4941	5243	5450	5459	5468	5666	5781

- 84" and 87" tall include four adjustable shelves and one fixed shelf.
- 90" tall includes five adjustable shelves and one fixed shelf.
- Top of doors match to a standard, full height base door, 34 1/2" high.
- To change the top rail valance, specify one of the following modifications: Arch (TVRAV), Furniture (TVRFV), or Straight Valance (TVRVV).
- Bookcases can only be reduced to 9".
- If ordered with Heirloom Technique, doors only will feature sand-through characteristics.

Custom Modifications

ADDTK	AUTH1	CBO	CCO	CFNT	CFP	CFRMO	CH	CND	CW	DRWPWR	DRWSEC	DRWTK	EXBK	EX	FBI	FFD	FPFB	FTK	FTK_V	ID	INFRM	MIP	PEINBTMB	PTOWB	RD	RECTK	RT	TVR_V	VTK	

Construction Upgrades

APC	PE

Door Options

DPSRR

¹ Minimum height is 69 1/4"

**TALL BOOKCASE with DOORS,
93" or 96" HIGH, 12" or 18" DEEP**

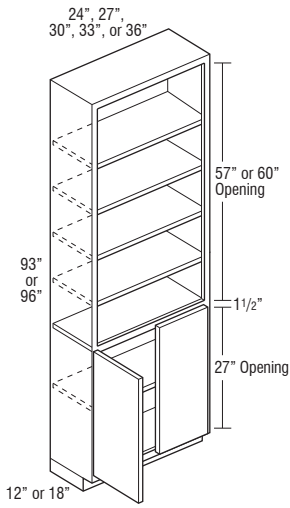
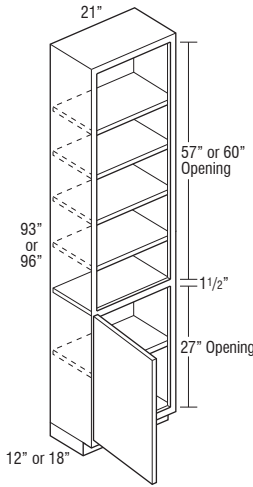

	Price Point	1	2	3	4	5	6	7	8	9	10	11	12
TBCD219312 L or R		3444	3494	3527	3559	3592	3623	3845	3994	4028	4060	4278	4322
TBCD219318 L or R		4032	4090	4128	4166	4204	4243	4501	4676	4715	4753	5010	5060
TBCD219612 L or R		3444	3494	3527	3559	3592	3623	3845	3994	4028	4060	4278	4322
TBCD219618 L or R		4032	4090	4128	4166	4204	4243	4501	4676	4715	4753	5010	5060

TBCD249312		3582	3634	3669	3703	3736	3770	4000	4154	4188	4220	4406	4496
TBCD279312		3658	3714	3780	3845	3910	3975	4216	4378	4407	4436	4676	4723
TBCD309312		3733	3793	3890	3986	4082	4178	4431	4601	4627	4652	4852	4950
TBCD339312		3819	3877	3974	4069	4164	4259	4518	4693	4714	4734	4980	5030
TBCD369312		3904	3961	4057	4152	4247	4342	4603	4782	4800	4817	5008	5109
TBCD249318		4192	4244	4287	4331	4375	4418	4686	4868	4897	4926	5122	5226
TBCD279318		4303	4358	4433	4507	4582	4656	4938	5132	5154	5177	5438	5492
TBCD309318		4415	4471	4576	4682	4787	4892	5188	5394	5411	5426	5643	5758
TBCD339318		4518	4574	4680	4786	4891	4996	5300	5509	5522	5534	5804	5862
TBCD369318		4620	4677	4784	4889	4995	5100	5411	5622	5631	5640	5845	5965
TBCD249612		3582	3634	3669	3703	3736	3770	4000	4154	4188	4220	4406	4496
TBCD279612		3658	3714	3780	3845	3910	3975	4216	4378	4407	4436	4676	4723
TBCD309612		3733	3793	3890	3986	4082	4178	4431	4601	4627	4652	4852	4950
TBCD339612		3819	3877	3974	4069	4164	4259	4518	4693	4714	4734	4980	5030
TBCD369612		3904	3961	4057	4152	4247	4342	4603	4782	4800	4817	5008	5109
TBCD249618		4192	4244	4287	4331	4375	4418	4686	4868	4897	4926	5122	5226
TBCD279618		4303	4358	4433	4507	4582	4656	4938	5132	5154	5177	5438	5492
TBCD309618		4415	4471	4576	4682	4787	4892	5188	5394	5411	5426	5643	5758
TBCD339618		4518	4574	4680	4786	4891	4996	5300	5509	5522	5534	5804	5862
TBCD369618		4620	4677	4784	4889	4995	5100	5411	5622	5631	5640	5845	5965

- 93" tall includes five adjustable shelves and one fixed shelf.
- 96" tall includes six adjustable shelves and one fixed shelf.
- Separate pedestal base included but packaged separately on 93" and 96" tall. Pedestals are the same width as the cabinet box except when specified with FPEB, in which the pedestal will be 1/4" recessed when centered.
- Top of doors match to a standard, full height base door, 34 1/2" high.
- To change the top rail valance, specify one of the following modifications: Arch (TVRAV), Furniture (TVRFV), or Straight Valance (TVRVV).
- Bookcases can only be reduced to 9".
- If ordered with Heirloom Technique, doors only will feature sand-through characteristics.

Custom Modifications

ADDTK	AUTH	CBO	CCO	CFNTO	CFP	CFRMO	CH	CND	CW	DRWPWR	DRWSEC	DRWTK	EXBK	EX	FB	FFD	FPEB	FTK	FTK_V	ID	INVFRM	MIP	PFINBTMB	PTOWB	RD	RECTK_RT	TVR_V	VTK	

Construction Upgrades

APC	PE
-----	----

Door Options

DPSRR
•

DESK DOOR DRAWER BASE, 29" HIGH, 21" or 24" DEEP

12", 15", 18", or 21"

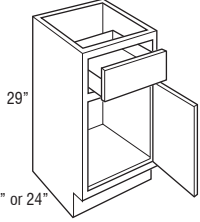

21" or 24"

24", 27", 30", 33", or 36"

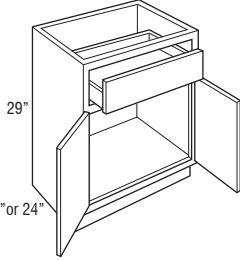

21" or 24"

Price Point

	1	2	3	4	5	6	7	8	9	10	11	12
DDO122921 L or R	737	787	796	805	814	823	865	896	930	959	983	1062
DDO152921 L or R	774	844	855	864	872	881	930	967	998	1032	1058	1141
DDO182921 L or R	799	876	886	896	906	915	965	998	1034	1070	1096	1184
DDO212921 L or R	822	912	923	933	944	954	1007	1040	1079	1113	1142	1232
DDO122924 L or R	753	809	818	827	836	843	887	922	953	983	1010	1091
DDO152924 L or R	790	869	879	888	897	906	956	988	1025	1060	1083	1169
DDO182924 L or R	815	898	908	918	928	939	993	1026	1062	1101	1126	1215
DDO212924 L or R	842	936	946	956	967	976	1032	1068	1107	1145	1172	1264

DDO242921	949	998	1010	1021	1033	1044	1101	1145	1184	1223	1252	1353
DDO272921	1021	1084	1098	1110	1122	1135	1197	1243	1287	1331	1363	1472
DDO302921	1094	1170	1185	1198	1213	1226	1291	1342	1389	1438	1472	1590
DDO332921	1219	1324	1340	1354	1370	1384	1463	1518	1570	1627	1667	1800
DDO362921	1344	1476	1493	1510	1527	1542	1630	1693	1754	1816	1860	2009
DDO242924	971	1026	1038	1049	1061	1072	1132	1172	1216	1254	1288	1391
DDO272924	1042	1116	1129	1141	1155	1167	1231	1276	1324	1365	1401	1514
DDO302924	1114	1205	1220	1233	1247	1260	1328	1379	1430	1474	1515	1636
DDO332924	1243	1361	1376	1392	1408	1422	1502	1560	1617	1669	1712	1851
DDO362924	1372	1516	1534	1551	1569	1586	1677	1739	1805	1863	1912	2068

- Depth can be reduced to a minimum of 12".
- Depth can be increased to a maximum of 24".

Custom Modifications

ADDTK	AUTH	CBO	CCO	CFNTO	CFP	CFRMO	CH	CND	CW	DRWPWR	DRWSEC	DRWTK	EXBK	EX	FB	FFD	FPEB	FTK	FTK_V	ID	INVFRM	MIP	PFINBTMB	PTOWB	RD	RECTK	RT	TVR_V	VTK
• ¹	•	•	•	•	•	•	•	•	•	• ²	• ³	• ⁴	• ³	•	•	•	•	•	•	• ⁵	• ⁶	•	•	•	•	•	•	•	•

Construction Upgrades

APC	PE
•	•

Door Options

DPSRR
•

¹ Not available on 21" deep
² Not available on 24" wide
³ Not available on 12" and 15" wide
⁴ Available only on 18", 21", and 24" wide
⁵ Not available on 12" wide
⁶ Not available on 24" deep

**DESK THREE DRAWER BASE,
29" HIGH, 21" or 24" DEEP**

12", 15", 18", 21",
24", 27", 30", 33", or 36"

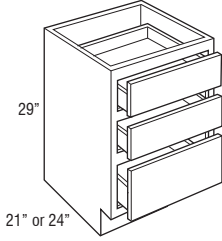

Price Point	1	2	3	4	5	6	7	8	9	10	11	12
3DB122921	1278	1285	1295	1304	1314	1323	1387	1432	1481	1521	1553	1673
3DB152921	1340	1346	1357	1369	1380	1390	1460	1505	1553	1599	1633	1756
3DB182921	1391	1398	1411	1424	1436	1448	1521	1571	1622	1672	1708	1837
3DB212921	1425	1431	1450	1469	1488	1508	1584	1639	1693	1742	1780	1915
3DB242921	1458	1466	1492	1518	1543	1568	1645	1702	1760	1810	1850	1997
3DB272921	1575	1583	1611	1637	1664	1691	1776	1839	1901	1954	1998	2157
3DB302921	1704	1712	1742	1770	1799	1827	1921	1986	2052	2111	2159	2331
3DB332921	1838	1847	1879	1911	1942	1973	2074	2144	2216	2279	2332	2517
3DB362921	1987	1997	2031	2064	2098	2131	2239	2317	2393	2462	2518	2719
3DB122924	1306	1313	1324	1334	1345	1355	1420	1473	1519	1559	1594	1717
3DB152924	1371	1378	1389	1399	1410	1420	1493	1542	1594	1635	1678	1802
3DB182924	1412	1419	1435	1450	1466	1482	1558	1612	1665	1712	1749	1888
3DB212924	1449	1456	1478	1501	1523	1544	1623	1679	1736	1783	1828	1967
3DB242924	1484	1492	1521	1549	1578	1606	1687	1744	1804	1855	1897	2044
3DB272924	1602	1609	1642	1673	1705	1736	1822	1883	1949	2003	2050	2208
3DB302924	1729	1738	1773	1807	1841	1875	1968	2034	2104	2164	2212	2384
3DB332924	1867	1876	1914	1951	1989	2026	2126	2196	2274	2336	2389	2574
3DB362924	2017	2027	2068	2108	2148	2187	2295	2373	2454	2522	2580	2781

- Depth can be reduced to a minimum of 12".
- Depth can be increased to a maximum of 24".

Custom Modifications

ADDTK	AUTH	CBO	CCO	CFNTO	CFP	CFRMO	CH	CND	CW	DRWPWR	DRWSEC	DRWTK	EXBK	EX	FB	FFD	FPFB	FTK	FTK_V	ID	INFRM	MIP	PFINBTMB	PTOWB	RD	RECTK	RT	TVR_V	VTK
			• ¹								• ²	• ³	• ⁴	• ³	•	•	•	•	• ²							•	•		•

Construction Upgrades

APC	PE
•	•

Door Options

DPSRR

- ¹ Not available on 21" deep
- ² Not available on 12" wide
- ³ Not available on 12" and 15" wide
- ⁴ Available only on 18", 21", and 24" wide, 24" deep

**DESK FILE DRAWER BASE,
29" HIGH, 21" or 24" DEEP**

15", 18", or 21"

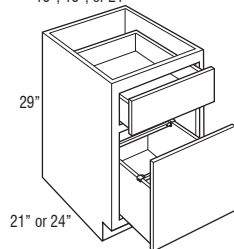

DFD152921	1261	1310	1324	1337	1351	1364	1436	1486	1540	1586	1626	1753
DFD182921	1355	1435	1450	1466	1482	1496	1575	1634	1691	1743	1785	1928
DFD212921	1454	1560	1577	1594	1611	1627	1714	1775	1840	1897	1947	2100
DFD152924	1289	1344	1359	1372	1385	1399	1472	1525	1576	1628	1667	1798
DFD182924	1385	1475	1490	1504	1519	1533	1618	1673	1732	1788	1833	1975
DFD212924	1482	1602	1618	1635	1652	1668	1758	1820	1888	1949	1997	2154

- Door is attached to file drawer.
- Includes Filing System Hardware Kit, which accommodates letter and legal filing.
- Exterior height of file drawer is 10".

Custom Modifications

ADDTK	AUTH	CBO	CCO	CFNTO	CFP	CFRMO	CH	CND	CW	DRWPWR	DRWSEC	DRWTK	EXBK	EX	FB	FFD	FPFB	FTK	FTK_V	ID	INFRM	MIP	PFINBTMB	PTOWB	RD	RECTK	RT	TVR_V	VTK
			• ¹								• ²	• ³	• ²	•	•	•	•	•	•							•	•		•

Construction Upgrades

APC	PE
•	•

Door Options

DPSRR

- ¹ Not available on 21" deep
- ² Not available on 15" wide
- ³ Available only on 18" and 21" wide, 24" deep

DESK DOUBLE FILE DRAWER BASE, 29" HIGH, 21" or 24" DEEP

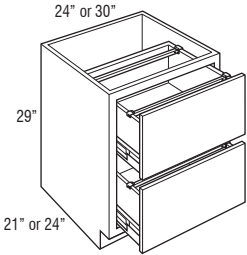

Price Point

	1	2	3	4	5	6	7	8	9	10	11	12
DDFD242921	1389	1553	1641	1728	1816	1902	2016	2098	2178	2259	2323	2516
DDFD302921	1534	1712	1810	1906	2003	2099	2228	2316	2406	2492	2563	2778
DDFD242924	1430	1599	1689	1779	1868	1957	2078	2157	2241	2325	2389	2589
DDFD302924	1578	1764	1864	1962	2061	2159	2293	2382	2475	2566	2638	2855

- Includes Filing System Hardware Kit, which accommodates letter and legal filing.
- Drawers utilize 125 lb. full extension progressive side-mount guide, does not feature soft-close guide.
- Bottom of drawer is not designed to support any weight.
- Exterior height of drawer box is 9 1/2".

Custom Modifications

ADDTK	AUTH	CBO	CCO	CFNTO	CFP	CFRMO	CH	CND	CW	DRWPWR	DRWSEC	DRWTK	EXBK	EX	FB	FFD	FPEB	FTK	FTK_V	ID	INVFRM	MIP	PFINBTMB	PTOWB	RD	RECTK	RT	TVR_V	VTK

Construction Upgrades

APC	PE
•	•

Door Options

DPSRR
•

¹ Not available on 21" deep

DESK EASY REACH, 29" HIGH, 21" or 24" DEEP

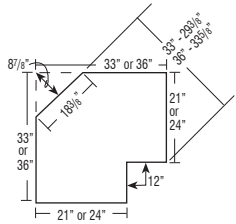
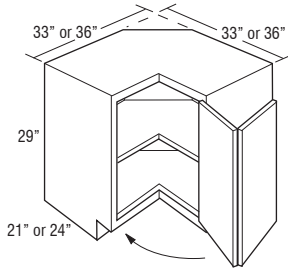

	1057	1235	1263	1290	1317	1344	1421	1482	1538	1593	1635	1771
DER333321 L or R												
DER363624 L or R	1084	1268	1297	1325	1354	1382	1466	1523	1587	1640	1687	1827

- Features one fixed shelf in center of cabinet.
- Decorative hardware screws must be countersunk to prevent scratching of adjacent cabinets and face frame of DER.
- DER333321 L or R wall width is 33" x 33".
- DER363624 L or R wall width is 36" x 36".
- Integrated soft-close hinge not included.

Custom Modifications

ADDTK	AUTH	CBO	CCO	CFNTO	CFP	CFRMO	CH	CND	CW	DRWPWR	DRWSEC	DRWTK	EXBK	EX	FB	FFD	FPEB	FTK	FTK_V	ID	INVFRM	MIP	PFINBTMB	PTOWB	RD	RECTK	RT	TVR_V	VTK

Construction Upgrades

APC	PE
•	•

Door Options

DPSRR
•

FURNITURE DRAWER, 6 3/4" HIGH, 24" DEEP

15", 18", 21", 24", 27", 30", 33", or 36"

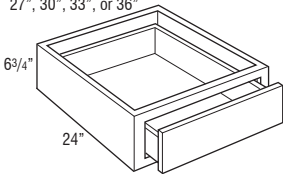

FD1506.7524	506	508	517	526	535	544	572	593	612	630	646	695
FD1806.7524	528	532	543	554	565	575	605	627	647	667	684	736
FD2106.7524	552	555	569	583	595	609	640	663	686	707	725	782
FD2406.7524	582	585	596	608	619	630	665	687	713	735	755	813
FD2706.7524	613	616	633	648	665	681	724	753	781	807	833	898
FD3006.7524	645	648	671	693	714	735	783	814	849	882	915	986
FD3306.7524	677	680	706	732	757	783	833	865	902	938	969	1045
FD3606.7524	707	711	741	771	801	831	882	917	955	993	1024	1104

- On partial overlay styles, drawer front to face frame is justified to the top to be consistent with current partial overlay reveal of 1". Bottom reveal is 1/4".
- Exterior height of drawer box is 3 3/8".

Custom Modifications

ADDTK	AUTH	CBO	CCO	CFNTO	CFP	CFRMO	CH	CND	CW	DRWPWR	DRWSEC	DRWTK	EXBK	EX	FB	FFD	FPEB	FTK	FTK_V	ID	INVFRM	MIP	PFINBTMB	PTOWB	RD	RECTK	RT	TVR_V	VTK

Construction Upgrades

APC	PE
•	•

Door Options

DPSRR
•

¹ Not available on 15" wide

FURNITURE DRAWER, 12" HIGH, 24" DEEP

15", 18", 21", 24", 27", 30", 33", or 36"

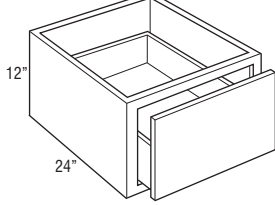

Price Point	1	2	3	4	5	6	7	8	9	10	11	12
FD151224	556	559	572	585	599	612	646	668	690	711	729	787
FD181224	579	583	600	616	634	650	684	710	733	755	774	836
FD211224	605	609	629	648	668	687	725	752	779	800	823	885
FD241224	642	645	662	678	695	712	753	780	806	833	854	923
FD271224	677	680	704	727	750	774	820	850	885	918	945	1022
FD301224	764	767	796	825	854	882	936	974	1011	1049	1085	1171
FD331224	800	805	838	871	905	936	993	1034	1072	1112	1148	1238
FD361224	837	841	879	916	954	992	1049	1093	1134	1174	1212	1305

- Drawer front to face frame reveal is justified to the bottom to be consistent with both full overlay and partial overlay. Partial overlay top reveal is 1 1/8" and bottom reveal is 1". Full overlay top reveal is 3/8" and bottom reveal is 1/4".
- Exterior height of drawer box is 6 3/8".

Custom Modifications

ADDTK	AUTH	CBO	CCO	CFNTO	CFP	CFRMO	CH	CND	CW	DRWPWR	DRWSEC	DRWTK	EXBK	EX	FB	FFD	FPEB	FTK	FTK_V	ID	INVFRM	MIP	PFINBTMB	PTOWB	RD	RECTK	RT	TVR_V	VTK
•	•	•	•	•	•	•	•	•	•	•	•	•	•	•	•	•	•	•	•	•	•	•	•	•	•	•	•	•	•

Construction Upgrades

APC	PE
•	•

Door Options

DPSRR

¹ Not available on 15" wide

FURNITURE DRAWER WINDOW BENCH, 18" HIGH, 24" DEEP

15", 18", 21", 24", 27", 30", 33", or 36"

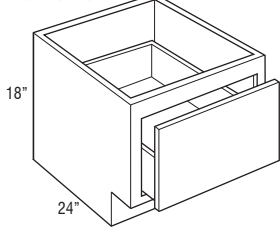

FDWB151824	712	715	729	744	757	772	801	828	849	869	885	945
FDWB181824	750	755	771	787	804	820	851	881	903	924	943	1004
FDWB211824	788	792	812	831	850	869	903	933	959	982	1001	1066
FDWB241824	837	841	857	873	888	903	945	974	1002	1026	1045	1115
FDWB271824	883	887	909	932	954	975	1024	1057	1091	1121	1149	1224
FDWB301824	982	986	1015	1042	1069	1095	1152	1188	1229	1265	1299	1386
FDWB331824	1024	1028	1061	1093	1125	1156	1215	1255	1295	1334	1369	1460
FDWB361824	1064	1069	1106	1144	1181	1218	1276	1322	1361	1402	1439	1533

- Drawer front to face frame reveal is justified to the bottom to be consistent with both full overlay and partial overlay. Partial overlay top reveal is 2 5/8" and bottom reveal is 1". Full overlay top reveal is 1 7/8" and bottom reveal is 1/4".
- Exterior height of drawer box is 6 3/8".

Custom Modifications

ADDTK	AUTH	CBO	CCO	CFNTO	CFP	CFRMO	CH	CND	CW	DRWPWR	DRWSEC	DRWTK	EXBK	EX	FB	FFD	FPEB	FTK	FTK_V	ID	INVFRM	MIP	PFINBTMB	PTOWB	RD	RECTK	RT	TVR_V	VTK
•	•	•	•	•	•	•	•	•	•	•	•	•	•	•	•	•	•	•	•	•	•	•	•	•	•	•	•	•	

Construction Upgrades

APC	PE
•	•

Door Options

DPSRR

¹ Not available on 15" wide

WOOD TOPS, ONE SIDED, 22 1/2" or 25 1/2" DEEP

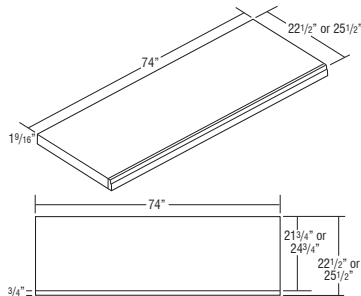

1TWT221	886	886	886	886	886	886	886	886	886	886	886	886
1TWT224	1007	1007	1007	1007	1007	1007	1007	1007	1007	1007	1007	1007

- 3/4" thick veneer over MDF panels with build-up strips to 1 1/2" thick and Traditional Countertop Moulding (TCM8) on front edge.

MODIFICATIONS

No modifications available for these products.

Construction Upgrades

APC	PE
•	•

Finish Techniques

Heirlooming
•

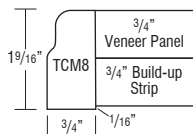

Model	Overall Width	Overall Depth
1TWT221	74"	22 1/2"
1TWT224	74"	25 1/2"

**WOOD TOPS, THREE SIDED,
22 1/2" or 25 1/2" DEEP**

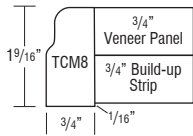
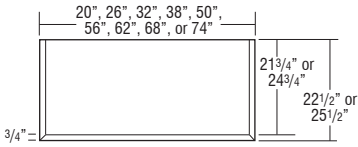
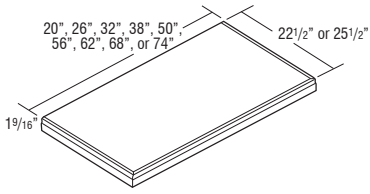

Model	Overall Width	Overall Depth
3TWT1821	20"	22 1/2"
3TWT2421	26"	22 1/2"
3TWT3021	32"	22 1/2"
3TWT3621	38"	22 1/2"
3TWT4821	50"	22 1/2"
3TWT5421	56"	22 1/2"
3TWT6021	62"	22 1/2"
3TWT6621	68"	22 1/2"
3TWT7221	74"	22 1/2"
3TWT1824	20"	25 1/2"
3TWT2424	26"	25 1/2"
3TWT3024	32"	25 1/2"
3TWT3624	38"	25 1/2"
3TWT4824	50"	25 1/2"
3TWT5424	56"	25 1/2"
3TWT6024	62"	25 1/2"
3TWT6624	68"	25 1/2"
3TWT7224	74"	25 1/2"

Price Point

	1	2	3	4	5	6	7	8	9	10	11	12
3TWT1821	267	267	267	267	267	267	267	267	267	267	267	267
3TWT2421	347	347	347	347	347	347	347	347	347	347	347	347
3TWT3021	427	427	427	427	427	427	427	427	427	427	427	427
3TWT3621	507	507	507	507	507	507	507	507	507	507	507	507
3TWT4821	668	668	668	668	668	668	668	668	668	668	668	668
3TWT5421	746	746	746	746	746	746	746	746	746	746	746	746
3TWT6021	828	828	828	828	828	828	828	828	828	828	828	828
3TWT6621	908	908	908	908	908	908	908	908	908	908	908	908
3TWT7221	987	987	987	987	987	987	987	987	987	987	987	987
3TWT1824	304	304	304	304	304	304	304	304	304	304	304	304
3TWT2424	393	393	393	393	393	393	393	393	393	393	393	393
3TWT3024	483	483	483	483	483	483	483	483	483	483	483	483
3TWT3624	575	575	575	575	575	575	575	575	575	575	575	575
3TWT4824	756	756	756	756	756	756	756	756	756	756	756	756
3TWT5424	849	849	849	849	849	849	849	849	849	849	849	849
3TWT6024	936	936	936	936	936	936	936	936	936	936	936	936
3TWT6624	1027	1027	1027	1027	1027	1027	1027	1027	1027	1027	1027	1027
3TWT7224	1118	1118	1118	1118	1118	1118	1118	1118	1118	1118	1118	1118

• 3/4" thick veneer over MDF panels with build-up strips to 1 1/2" thick and Traditional Countertop Moulding (TCM8) on front and side edges.

MODIFICATIONS

No modifications available for these products.

Construction Upgrades

APC	PE
•	

Finish Techniques

Heirlooming
•

WOOD TOPS, FOUR SIDED, 27" or 33" DEEP

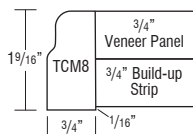
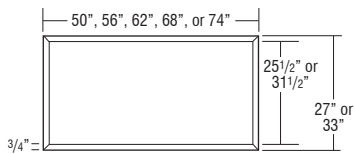
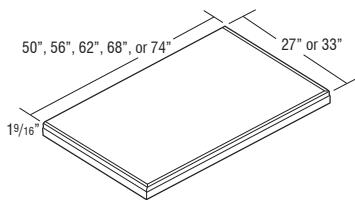

Model	Overall Width	Overall Depth
4TWT4827	50"	27"
4TWT5427	56"	27"
4TWT6027	62"	27"
4TWT6627	68"	27"
4TWT7227	74"	27"
4TWT4833	50"	33"
4TWT5433	56"	33"
4TWT6033	62"	33"
4TWT6633	68"	33"
4TWT7233	74"	33"

	Price Point	1	2	3	4	5	6	7	8	9	10	11	12
4TWT4827		861	861	861	861	861	861	861	861	861	861	861	861
4TWT5427		965	965	965	965	965	965	965	965	965	965	965	965
4TWT6027		1068	1068	1068	1068	1068	1068	1068	1068	1068	1068	1068	1068
4TWT6627		1173	1173	1173	1173	1173	1173	1173	1173	1173	1173	1173	1173
4TWT7227		1276	1276	1276	1276	1276	1276	1276	1276	1276	1276	1276	1276
4TWT4833		1052	1052	1052	1052	1052	1052	1052	1052	1052	1052	1052	1052
4TWT5433		1178	1178	1178	1178	1178	1178	1178	1178	1178	1178	1178	1178
4TWT6033		1307	1307	1307	1307	1307	1307	1307	1307	1307	1307	1307	1307
4TWT6633		1432	1432	1432	1432	1432	1432	1432	1432	1432	1432	1432	1432
4TWT7233		1558	1558	1558	1558	1558	1558	1558	1558	1558	1558	1558	1558

• 3/4" thick veneer over MDF panels with build-up strips to 1 1/2" thick and Traditional Countertop Moulding (TCM8) on front, back, and side edges.

MODIFICATIONS
No modifications available for these products.

Construction Upgrades

APC	PE
•	

Finish Techniques

Heirlooming
•

UNDER COUNTER DRAWER, 4 3/4" HIGH, 21" DEEP

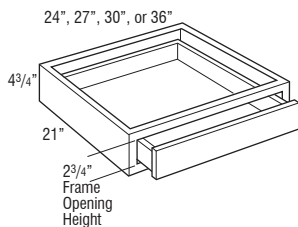

UCD2421	476	478	484	488	493	497	524	547	566	585	601	651
UCD2721	538	540	545	551	557	562	596	623	651	680	721	777
UCDS3021	627	631	636	642	647	653	693	718	745	767	787	852
UCDS3621	718	721	728	735	741	747	793	829	866	905	952	1026

- Cabinet is 4 3/4" high. Drawer box within cabinet is 2" high (outside dimension).
- Not trimmable.
- Drawer front is 3/4" slab front.
- The frame to end panel offset is 3/4", which is designed to accommodate the vanity desk leg.
- Reduced depth is available in 3" increments.

Custom Modifications

ADDTK	AUTH	CBO	CCO	CFNTO	CFP	CFRMO	CH	CND	CW	DRWPWR	DRWSEC	DRWTK	EXBK	EX	FB	FFD	FPFB	FTK	FTK_V	ID	INFRM	MIP	PFINBTAB	PTOWB	RD	RECTK	RT	TVR	VTK	

Construction Upgrades

APC	PE
•	STD

Door Options

DPSRR

UNDER COUNTER DRAWER TRIMMABLE, 4 3/4" HIGH, 21" DEEP

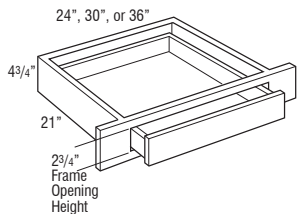

UCDT2421	476	478	484	488	493	497	524	547	566	585	601	651
UCDT3021	627	631	636	642	647	653	693	718	745	767	787	852
UCDT3621	718	721	728	735	741	747	793	829	866	905	952	1026

- Cabinet is 4 3/4" high. Drawer box within cabinet is 2" high (outside dimension).
- Frame stile is trimmable 3" on each side.
- Drawer front is 3/4" slab front.
- The frame to end panel offset is 3/4", which is designed to accommodate the vanity desk leg.
- Reduced depth is available in 3" increments.

Custom Modifications

ADDTK	AUTH	CBO	CCO	CFNTO	CFP	CFRMO	CH	CND	CW	DRWPWR	DRWSEC	DRWTK	EXBK	EX	FB	FFD	FPFB	FTK	FTK_V	ID	INFRM	MIP	PFINBTAB	PTOWB	RD	RECTK	RT	TVR	VTK	

Construction Upgrades

APC	PE
•	STD

Door Options

DPSRR

TABLE OF CONTENTS – VANITY CABINETS

Full Height Door Vanity Sink Base Cabinets	227
False Panel Vanity Sink Base Cabinets	229
Vanity Organization and Specialty Cabinets	231
Vanity Base Cabinets	232
Vanity Corner Cabinets	233
Vanity Drawer Base Cabinets	234
Wastebaskets	235
Pull-outs	236
Vanity Sink Drawer Base Cabinets	237
Under Counter Drawers	247
Hampers	247
Vanity Tall Cabinets	248
Vanity Wall Cabinets and Mirrors	250

VANITY CABINETS

VANITY CABINET NOMENCLATURE

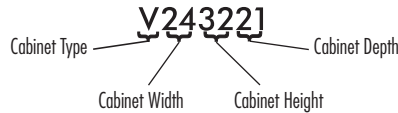

MODIFICATIONS GRID KEY

•	Available
STD	Standard on these cabinets

CONSTRUCTION UPGRADES

Mod.	Description
APC	All-plywood Construction
PE	Plywood Ends

DOOR OPTIONS

Mod.	Description
ALF	Aluminum Frame Doors
CG	Cut-for-glass Doors
DPSRR	Door Panel - Solid Reverse Raised
MD	Mullion Doors
MFO	Modified Full Overlay

CUSTOM MODIFICATIONS

Mod.	Description	Mod.	Description
AUTHB	Authentic Ends - Both	FFDL	Face Frame and Door on End - Left
AUTHL	Authentic End - Left	FFDR	Face Frame and Door on End - Right
AUTHR	Authentic End - Right	FPEB	Furniture Finished Plywood Ends
CBO	Cabinet Box Only	FTK	Flush Toekick
CCO	Cabinet Case Only	FTKAV	Flush Toekick Arch
CFNTO	Cabinet Front Only	FTKRV	Flush Toekick Furniture
CFP	Cabinet False Panel	ID	Increased Depth
CFRMO	Cabinet Frame Only	INFRM	Inverted Frame
CH	Custom Height	MIP	Matching Interior Plywood
CMAT	CabMat™	RD	Reduced Depth
CND	Cabinet with No Door, with Drawer	RECTKALL	Recessed Island Toekick
CW	Custom Width	RECTKBK	Recessed Toekick - Back
DRWPWR	PowerGlide™ Compact Drawer Outlet	RECTKL	Recessed Toekick - Left
DRWTK	Toekick Drawer	RECTKR	Recessed Toekick - Right
EXBKL	End Extended Back - Left	RT	Installed Roll Tray
EXBKR	End Extended Back - Right	TKP	Loose Toekick
EXL	Extended Stile - Left	TOTSSS	Tilt-out Tray, Stainless Steel Slim
EXR	Extended Stile - Right	VTK	Void Toekick
FB	Finished Ends		

Standard vanity toekick is 4 1/2" tall, which will align with standard base cabinets.

Distance between back of drawer box and back interior of cabinet is 2 3/4".

Vanity cabinets are shipped with an unfinished toekick. Finished toekicks in matching wood veneer or laminate must be ordered separately and field installed.

All vanity cabinets are predrilled for full depth shelves or roll trays.

There will be no charge for RD18 on 21" deep vanity cabinets.

For Linen cabinets, Tall mitered door styles and laminate door styles will feature one center panel, other door styles will feature two center panels.

Horizontal grain doors greater than 48" high will be two doors doweled together.

**VANITY BASE, 32" HIGH,
21" DEEP**

12", 15", 18", 21", or 24"

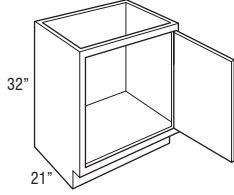

24", 27", 30", 33", or 36"

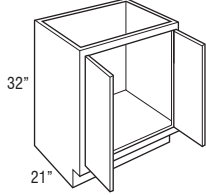

39", 42", 45", or 48"

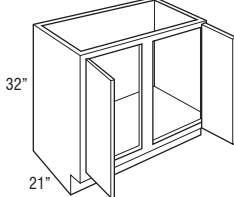

48" or 60"

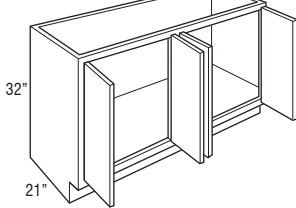

Price
Point

	1	2	3	4	5	6	7	8	9	10	11	12
V123221 L or R	491	535	556	575	595	614	652	675	704	731	746	808
V153221 L or R	516	562	584	605	626	647	687	711	740	769	786	851
V183221 L or R	545	591	614	635	657	679	722	748	780	809	828	897
V213221 L or R	592	642	666	691	716	739	784	813	846	879	900	974
V243221 L or R	643	700	726	752	777	803	853	885	921	956	978	1061

V243221	678	735	763	791	819	847	899	931	969	1008	1030	1114
V273221	693	759	792	824	857	889	945	983	1024	1062	1091	1182
V303221	708	792	828	862	897	932	990	1030	1074	1112	1144	1238
V333221	731	829	867	904	941	978	1037	1079	1120	1159	1194	1291
V363221	752	867	905	942	979	1016	1079	1123	1166	1205	1240	1343

V393221	805	920	955	990	1026	1061	1124	1167	1213	1259	1290	1400
V423221	860	971	1004	1036	1068	1101	1169	1212	1262	1310	1343	1457
V453221	886	1024	1060	1095	1131	1166	1236	1286	1335	1384	1421	1541
V483221CS	953	1077	1116	1154	1192	1229	1305	1354	1409	1462	1501	1625

V483221	1034	1182	1225	1269	1313	1355	1439	1494	1555	1611	1656	1793
V603221	1343	1534	1592	1649	1706	1763	1869	1944	2022	2094	2153	2331

Custom Modifications

AUTH	CBO	CCO	CFNTO	CFP	CFRMO	CH	CMAT	CND	CW	DRWPWR	DRWTK	EXBK	EX	FB	FFD	FPEB	FTK	FTK_V	ID	INVFRM	MIP	RD	RECTK	RT	TKP	TOTSSS	VTK
•	•	•	•	•	•	•	• ¹	•	• ²	•	• ³	•	•	•	•	•	•	• ⁴	•	•	•	•	•	•	•	•	•

Construction Upgrades

APC	PE
•	•

Door Options

ALF	CG	DPSRR	MD	MFO
•	•	•	•	•

¹ Not available on 12", 15", 18", 21", 39", 42", and 45" wide

² Not available on 24" (2 doors), 48" (4 doors), and 60" wide

³ Not available on 12", 15", 39", 42", 45", 48", and 60" wide

⁴ Not available on 12" wide

VANITY BASE, 34 1/2" HIGH, 21" DEEP

12", 15", 18", 21", or 24"

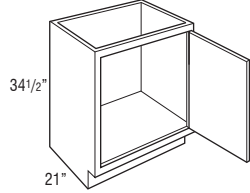

24", 27", 30", 33", or 36"

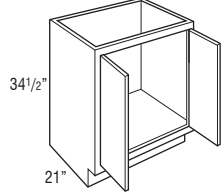

39", 42", 45", or 48"

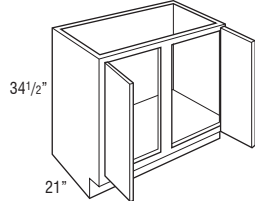

48" or 60"

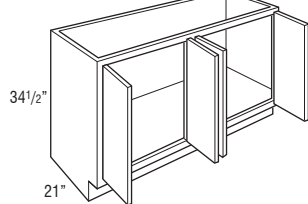

Price Point	1	2	3	4	5	6	7	8	9	10	11	12
V123421 L or R	530	567	589	612	634	656	694	721	750	776	799	865
V153421 L or R	557	598	622	645	669	692	729	759	788	818	840	912
V183421 L or R	586	628	653	678	702	726	768	800	831	860	885	959
V213421 L or R	636	683	710	737	764	791	834	869	900	933	962	1042
V243421 L or R	691	745	774	802	830	858	909	942	980	1016	1044	1132

V243421	727	783	814	844	875	905	956	993	1032	1070	1099	1193
V273421	776	828	879	931	982	1033	1095	1139	1185	1229	1261	1365
V303421	831	885	935	984	1035	1084	1149	1197	1243	1288	1325	1436
V333421	846	900	959	1016	1074	1131	1197	1244	1295	1342	1379	1496
V363421	884	940	998	1056	1114	1172	1243	1292	1343	1394	1428	1548

V393421	909	970	1029	1089	1148	1206	1282	1331	1384	1436	1472	1594
V423421	934	995	1057	1119	1182	1243	1320	1369	1425	1475	1518	1641
V453421	967	1048	1103	1157	1212	1266	1343	1394	1452	1501	1543	1672
V483421CS	1005	1102	1149	1195	1241	1287	1366	1418	1477	1529	1570	1699

V483421	1073	1206	1238	1269	1300	1331	1412	1465	1527	1581	1623	1756
V603421	1398	1566	1607	1648	1688	1728	1836	1907	1984	2056	2110	2285

Custom Modifications

AUTH	CBO	CCO	CFNTO	CFP	CFRMO	CH	CMAT	CND	CW	DRWPWR	DRWTK	EXBK	EX	FB	FFD	FPEB	FTK	FTK_V	ID	INVFRM	MIP	RD	RECTK	RT	TKP	TOTSSS	VTK
•	•	•	•	•	•	•	• ¹	• ²	•	• ³	•	•	•	•	•	•	•	• ⁴	•	•	•	•	•	•	•	•	•

Construction Upgrades

APC	PE
•	•

Door Options

ALF	CG	DPSRR	MD	MFO
•	•	•	•	•

¹ Not available on 12", 15", 18", 21", 39", 42", and 45" wide

² Not available on 24" (2 doors), 48" (4 doors), and 60" wide

³ Not available on 12", 15", 39", 42", 45", 48" and 60" wide

⁴ Not available on 12" wide

VANITY SINK BASE with FALSE PANEL, 32" HIGH, 21" DEEP

15", 18", 21", or 24"

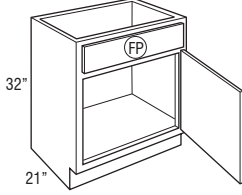

24", 27", 30", 33", or 36"

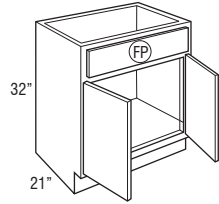

39", 42", 45", or 48"

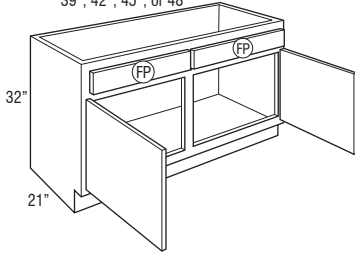

48", 54", or 60"

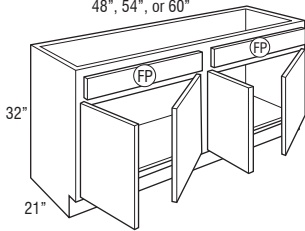

(FP) = False Panel

Price Point

	1	2	3	4	5	6	7	8	9	10	11	12
VSB153221 L or R	597	643	669	694	720	745	790	816	849	884	907	982
VSB183221 L or R	626	678	704	730	756	782	830	861	894	928	955	1034
VSB213221 L or R	681	737	766	794	823	851	903	935	973	1011	1037	1124
VSB243221 L or R	741	803	833	864	894	924	980	1019	1056	1096	1128	1222

VSB243221	781	843	876	908	941	973	1033	1072	1112	1155	1185	1285
VSB273221	797	872	911	949	987	1024	1090	1130	1177	1221	1252	1359
VSB303221	813	914	954	993	1034	1073	1141	1187	1235	1279	1315	1422
VSB333221	840	951	995	1038	1082	1126	1193	1241	1291	1335	1373	1488
VSB363221	866	996	1039	1083	1127	1169	1240	1292	1342	1389	1426	1544

VSB393221	900	1056	1098	1138	1179	1220	1290	1344	1398	1448	1486	1609
VSB423221	990	1116	1154	1192	1230	1268	1343	1397	1453	1505	1544	1676
VSB453221	1018	1176	1217	1259	1300	1341	1421	1478	1538	1594	1634	1772
VSB483221CS	1096	1236	1281	1325	1370	1413	1500	1557	1620	1680	1725	1868

VSB483221	1187	1355	1407	1457	1508	1558	1655	1719	1790	1850	1903	2062
VSB543221	1340	1450	1505	1559	1614	1668	1771	1839	1915	1979	2035	2205
VSB603221	1478	1600	1660	1719	1779	1838	1953	2028	2112	2183	2244	2432

Custom Modifications

AUTH	CBO	CCO	CFNTO	CFP	CFRMO	CH	CMAT	CND	CW	DRWPWR	DRWTK	EXBK	EX	FB	FFD	FPEB	FTK	FTK_V	ID	INVFRM	MIP	RD	RECTK	RT	TKP	TOTSSS	VTK
•	•	•	•	STD	•	•	• ¹	•	• ²	• ³	•	•	•	•	•	•	•	•	•	•	•	•	•	•	•	•	•

Construction Upgrades

APC	PE
•	•

Door Options

ALF	CG	DPSRR	MD	MFO
•	•	•	•	•

¹ Not available on 15", 18", 21", 39", 42", and 45" wide

² Not available on 15", 24" (2 doors), 48" (4 doors), 54", and 60" wide

³ Not available on 15", 39", 42", 48", 54", and 60" wide

229

VANITY CABINETS

VANITY SINK BASE with FALSE PANEL, 34 1/2" HIGH, 21" DEEP

15", 18", 21", or 24"

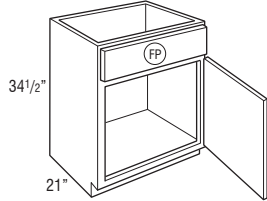

24", 27", 30", 33", or 36"

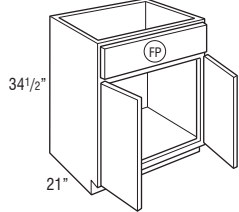

39", 42", 45", or 48"

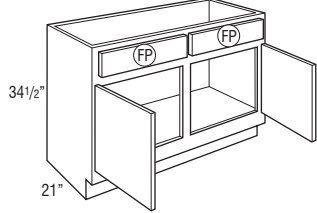

48", 54", or 60"

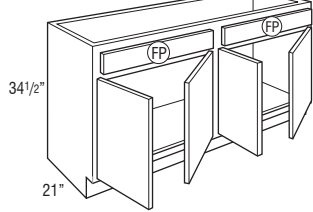

FP = False Panel

Price Point

	1	2	3	4	5	6	7	8	9	10	11	12
VS 153421 L or R	640	687	715	741	768	795	837	874	907	939	969	1045
VS 183421 L or R	673	725	753	780	808	834	881	922	953	989	1019	1101
VS 213421 L or R	730	787	819	849	879	909	960	999	1037	1076	1107	1197
VS 243421 L or R	794	857	889	922	954	986	1043	1088	1127	1170	1202	1303

VS 243421	836	898	934	969	1004	1038	1096	1146	1187	1231	1267	1372
VS 273421	890	949	1009	1070	1130	1189	1260	1307	1361	1412	1450	1571
VS 303421	954	1019	1076	1132	1189	1245	1325	1375	1429	1480	1523	1649
VS 333421	976	1037	1102	1167	1232	1297	1378	1430	1487	1541	1588	1721
VS 363421	1019	1082	1148	1214	1280	1346	1429	1483	1543	1603	1642	1781

VS 393421	1046	1113	1183	1252	1322	1390	1473	1529	1590	1651	1692	1836
VS 423421	1074	1146	1217	1288	1359	1429	1518	1574	1639	1699	1744	1891
VS 453421	1132	1206	1269	1331	1392	1454	1543	1603	1668	1730	1774	1924
VS 483421CS	1175	1266	1319	1373	1427	1480	1570	1631	1697	1760	1805	1956

VS 483421	1257	1387	1422	1458	1494	1529	1623	1684	1755	1819	1867	2020
VS 543421	1501	1625	1687	1747	1808	1868	1984	2061	2145	2218	2279	2470
VS 603421	1655	1793	1860	1926	1994	2060	2187	2272	2364	2445	2514	2724

Custom Modifications

AUTH	CBO	CCO	CFNTO	CFP	CFRMO	CH	CMAT	CND	CW	DRWPWR	DRWTK	EXBK	EX	FB	FFD	FPEB	FTK	FTK_V	ID	INVERM	MIP	RD	RECTK	RT	TKP	TOTSSS	VTK
•	•	•	•	STD	•	•	• ¹	•	• ²		• ³	•	•	•	•	•	•	•	•	•	•	•	•	•	•	•	•

Construction Upgrades

APC	PE
•	•

Door Options

ALF	CG	DPSRR	MD	MFO
		•		

¹ Not available on 15", 18", 21", 39", 42", and 45" wide

² Not available on 15", 24" (2 doors), 48" (4 doors), 54", and 60" wide

³ Not available on 15", 39", 42", 48", 54", and 60" wide

VANITY SINK BASE with U-SHAPED PULL-OUT TRAYS, 32" HIGH, 21" DEEP

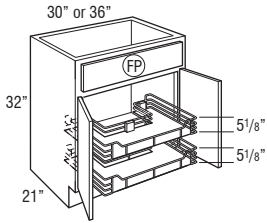

FP = False Panel

	Price Point	1	2	3	4	5	6	7	8	9	10	11	12
VSB303221U		1647	1748	1788	1827	1868	1907	1975	2021	2069	2113	2149	2256
VSB363221U		1754	1884	1927	1971	2015	2057	2128	2180	2230	2277	2314	2432

- Includes two chrome U-shaped soft-close pull-outs with gray shelf liner.
- VSB303221U Bottom pull-out is 25 1/4" wide and 17" deep. Cut-out for U-shape is 6 1/8" from back of cabinet and 15 3/4" wide. Top pull-out is 25 1/4" wide and 17" deep. Cut-out for U-shape is 12 1/8" from back of cabinet and 15 3/4" wide.
- VSB363221U Bottom pull-out is 31 1/4" wide and 17" deep. Cut-out for U-shape is 6 1/8" from back of cabinet and 15 3/4" wide. Top pull-out is 31 1/4" wide and 17" deep. Cut-out for U-shape is 12 1/8" from back of cabinet and 15 3/4" wide.

Custom Modifications

AUTH	CBO	CCO	CFNTO	CFP	CFRMO	CH	CMAT	CND	CW	DRWPWR	DRWTK	EXBK	EX	FB	FFD	FPEB	FTK	FTK_V	ID	INVFRM	MIP	RD	RECTK	RT	TKP	TOTSSS	VTK
•	•	•	•	•	•	•	•	•	•	•	•	•	•	•	•	•	•	•	•	•	•	•	•	•	•	•	•

Construction Upgrades

APC	PE
•	•

Door Options

ALF	CG	DPSRR	MD	MFO
		•		

VANITY SINK BASE with U-SHAPED PULL-OUT TRAYS, 34 1/2" HIGH, 21" DEEP

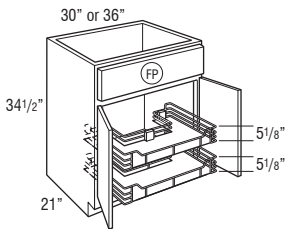

FP = False Panel

VSB303421U	1788	1853	1910	1966	2023	2079	2159	2209	2263	2314	2357	2483
VSB363421U	1907	1970	2036	2102	2168	2234	2317	2371	2431	2491	2530	2669

- Includes two chrome U-shaped soft-close pull-outs with gray shelf liner.
- VSB303421U Bottom pull-out is 25 1/4" wide and 17" deep. Cut-out for U-shape is 6 1/8" from back of cabinet and 15 3/4" wide. Top pull-out is 25 1/4" wide and 17" deep. Cut-out for U-shape is 12 1/8" from back of cabinet and 15 3/4" wide.
- VSB363421U Bottom pull-out is 31 1/4" wide and 17" deep. Cut-out for U-shape is 6 1/8" from back of cabinet and 15 3/4" wide. Top pull-out is 31 1/4" wide and 17" deep. Cut-out for U-shape is 12 1/8" from back of cabinet and 15 3/4" wide.

Custom Modifications

AUTH	CBO	CCO	CFNTO	CFP	CFRMO	CH	CMAT	CND	CW	DRWPWR	DRWTK	EXBK	EX	FB	FFD	FPEB	FTK	FTK_V	ID	INVFRM	MIP	RD	RECTK	RT	TKP	TOTSSS	VTK
•	•	•	•	•	•	•	•	•	•	•	•	•	•	•	•	•	•	•	•	•	•	•	•	•	•	•	•

Construction Upgrades

APC	PE
•	•

Door Options

ALF	CG	DPSRR	MD	MFO
		•		

VANITY SINK BASE SUPERCABINET™ with TILT-OUT TRAYS, 34 1/2" HIGH, 21" DEEP

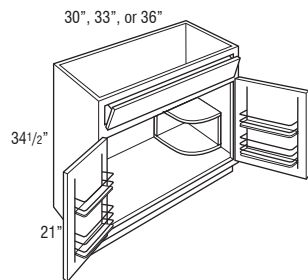

FP = False Panel

VSSB303421ST	1567	1632	1689	1745	1802	1858	1938	1988	2042	2093	2136	2262
VSSB333421ST	1589	1650	1715	1780	1845	1910	1991	2043	2100	2154	2201	2334
VSSB363421ST	1632	1695	1761	1827	1893	1959	2042	2096	2156	2216	2255	2394

- Quarter Round Reversible Shelf for left or right applications will be constructed from 3/4" thick laminated furniture board. (Shelf shipped secure, can be positioned in left or right corner.)
- Each door features a chrome and wood two-tiered rack.
- Door rack width is 11 3/8" on 30" and 33" wide cabinets and 14 3/8" on 36" wide cabinet.
- Door rack depth is 3 1/2".
- Includes 2 installed tilt-out trays.
- Tilt-out trays are stain resistant, moisture resistant plastic to allow storage of sponges & other cleaning materials.
- Tilt-out trays are also available as an accessory for field installation. See page 315.

Custom Modifications

AUTH	CBO	CCO	CFNTO	CFP	CFRMO	CH	CMAT	CND	CW	DRWPWR	DRWTK	EXBK	EX	FB	FFD	FPEB	FTK	FTK_V	ID	INVFRM	MIP	RD	RECTK	RT	TKP	TOTSSS	VTK
•	•	•	•	•	•	•	•	•	•	•	•	•	•	•	•	•	•	•	•	•	•	•	•	•	•	•	•

Construction Upgrades

APC	PE
•	•

Door Options

ALF	CG	DPSRR	MD	MFO
		•		

VANITY BASE, SINGLE DOOR with DRAWER, 32" HIGH, 21" DEEP

12", 15", 18", 21", or 24"

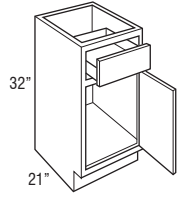

Price Point	1	2	3	4	5	6	7	8	9	10	11	12
VB123221 L or R	737	787	796	805	814	823	865	896	930	959	983	1062
VB153221 L or R	774	844	855	864	872	881	930	967	998	1032	1058	1141
VB183221 L or R	799	876	886	896	906	915	965	998	1034	1070	1096	1184
VB213221 L or R	841	909	921	931	942	952	1005	1037	1077	1109	1140	1231
VB243221 L or R	924	982	993	1005	1016	1027	1085	1124	1166	1202	1233	1333

Custom Modifications

AUTH	CBO	CCO	CFNTO	CFP	CFRMO	CH	CMAT	CND	CW	DRWPWR	DRWTK	EXBK	EX	FB	FFD	FPFB	FTK	FTK_V	ID	INVFRM	MIP	RD	RECTK_RT	TKP	TOTSSS	VTK
•	•	•	•	•	•	•	•	•	•	• ¹	•	•	•	•	•	•	•	• ²	•	•	•	•	•	•	•	•

Construction Upgrades

APC	PE
•	•

Door Options

ALF	CG	DPSRR	MD	MFO
•	•	•	•	•

¹ Not available on 12" and 15" wide

² Not available on 12" wide

VANITY BASE, SINGLE DOOR with DRAWER, 34 1/2" HIGH, 21" DEEP

12", 15", 18", 21", or 24"

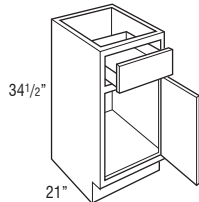

VB123421 L or R	781	830	839	847	856	864	912	942	977	1010	1037	1116
VB153421 L or R	827	870	880	889	898	907	958	990	1026	1062	1086	1173
VB183421 L or R	848	918	928	939	949	959	1011	1048	1084	1119	1149	1240
VB213421 L or R	907	981	996	1009	1023	1036	1093	1130	1172	1211	1240	1341
VB243421 L or R	973	1047	1063	1079	1094	1109	1173	1214	1261	1303	1336	1444

Custom Modifications

AUTH	CBO	CCO	CFNTO	CFP	CFRMO	CH	CMAT	CND	CW	DRWPWR	DRWTK	EXBK	EX	FB	FFD	FPFB	FTK	FTK_V	ID	INVFRM	MIP	RD	RECTK_RT	TKP	TOTSSS	VTK
•	•	•	•	•	•	•	•	•	•	• ¹	• ¹	•	•	•	•	•	•	•	• ²	•	•	•	•	•	•	•

Construction Upgrades

APC	PE
•	•

Door Options

ALF	CG	DPSRR	MD	MFO
•	•	•	•	•

¹ Not available on 12" and 15" wide

² Not available on 12" wide

VANITY BASE, DOUBLE DOOR with DRAWER, 32" HIGH, 21" DEEP

24", 27", 30", 33", or 36"

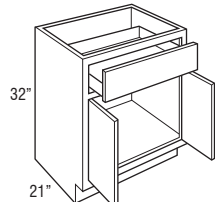

39", 42", 45", or 48"

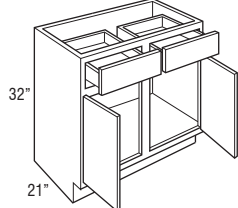

48"

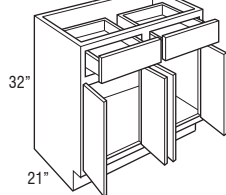

VB243221	1004	1057	1070	1081	1092	1103	1166	1210	1252	1292	1326	1434
VB273221	1120	1182	1194	1206	1219	1231	1298	1351	1398	1444	1478	1596
VB303221	1184	1245	1259	1271	1285	1297	1371	1425	1476	1523	1559	1686
VB333221	1225	1291	1305	1317	1331	1343	1418	1476	1527	1576	1616	1745
VB363221	1268	1334	1348	1363	1378	1391	1468	1527	1581	1631	1672	1805
VB393221	1343	1416	1430	1445	1459	1473	1557	1617	1673	1728	1771	1912
VB423221	1418	1493	1509	1524	1540	1555	1642	1707	1765	1824	1867	2018
VB453221	1487	1568	1585	1600	1617	1633	1726	1793	1856	1917	1961	2118
VB483221CS	1558	1644	1661	1678	1695	1711	1808	1879	1944	2008	2055	2220

VB483221	1700	1792	1811	1829	1848	1866	1972	2048	2120	2188	2241	2423
-----------------	------	------	------	------	------	------	------	------	------	------	------	------

Custom Modifications

AUTH	CBO	CCO	CFNTO	CFP	CFRMO	CH	CMAT	CND	CW	DRWPWR	DRWTK	EXBK	EX	FB	FFD	FPFB	FTK	FTK_V	ID	INVFRM	MIP	RD	RECTK_RT	TKP	TOTSSS	VTK
•	•	•	•	•	•	•	•	•	•	•	• ²	•	•	•	•	•	•	•	•	•	•	•	•	•	•	•

Construction Upgrades

APC	PE
•	•

Door Options

ALF	CG	DPSRR	MD	MFO
•	•	•	•	•

¹ Not available on 24" and 48" (4 doors) wide

² Not available on 39", 42", 45" and 48" wide

VANITY BASE, DOUBLE DOOR with DRAWER, 34 1/2" HIGH, 21" DEEP

24", 27", 30", 33", or 36"

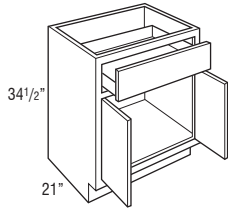

39", 42", 45", or 48"

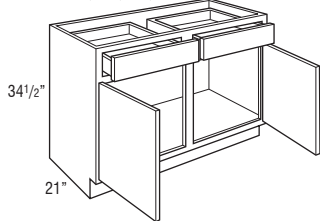

48"

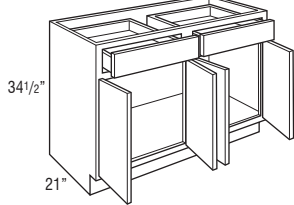

Price Point

	1	2	3	4	5	6	7	8	9	10	11	12
VB243421	1040	1112	1131	1149	1167	1185	1252	1299	1348	1392	1428	1542
VB273421	1160	1241	1261	1281	1301	1322	1397	1450	1503	1551	1593	1720
VB303421	1225	1307	1329	1352	1374	1396	1473	1529	1587	1635	1681	1816
VB333421	1268	1354	1376	1399	1421	1444	1525	1585	1642	1692	1739	1879
VB363421	1310	1402	1426	1449	1473	1495	1579	1640	1699	1753	1800	1945

VB393421	1391	1485	1510	1534	1559	1584	1674	1736	1800	1858	1906	2062
VB423421	1466	1568	1595	1621	1646	1672	1766	1831	1901	1958	2013	2174
VB453421	1542	1648	1674	1701	1728	1754	1854	1923	1997	2057	2115	2285
VB483421CS	1613	1725	1754	1782	1810	1838	1942	2015	2091	2155	2214	2393

VB483421	1761	1880	1912	1942	1973	2004	2117	2197	2280	2352	2416	2610
-----------------	------	------	------	------	------	------	------	------	------	------	------	------

Custom Modifications

AUTH	CBO	CCO	CFNTO	CFP	CFRMO	CH	CMAT	CND	CW	DRWPWR	DRWTK	EXBK	EX	FB	FFD	FPEB	FTK	FTK_V	ID	INVFRM	MIP	RD	RECTK	RT	TKP	TOTSSS	VTK
•	•	•	•	•	•	•	•	•	•	• ¹	•	• ²	•	•	•	•	•	•	•	•	•	•	•	•	•	•	•

Construction Upgrades

APC	PE
•	•

Door Options

ALF	CG	DPSRR	MD	MFO
		•		

¹ Not available on 24" and 48" (4 doors) wide
² Not available on 39", 42", 45", and 48" wide

VANITY BASE EASY REACH, 32" HIGH, 21" DEEP

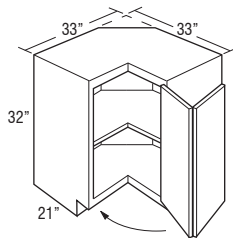

VER333221 L or R	1060	1133	1198	1262	1327	1391	1474	1534	1595	1654	1699	1840
-------------------------	------	------	------	------	------	------	------	------	------	------	------	------

- Decorative hardware screws must be countersunk to prevent scratching adjacent cabinets and face frame of VER.
- Includes one 1/2" thick fixed shelf in center of cabinet.
- Integrated soft-close hinge not included.

Custom Modifications

AUTH	CBO	CCO	CFNTO	CFP	CFRMO	CH	CMAT	CND	CW	DRWPWR	DRWTK	EXBK	EX	FB	FFD	FPEB	FTK	FTK_V	ID	INVFRM	MIP	RD	RECTK	RT	TKP	TOTSSS	VTK
•	•					•								•	•						•		•				•

Construction Upgrades

APC	PE
•	•

Door Options

ALF	CG	DPSRR	MD	MFO
		•		

VANITY BASE EASY REACH, 34 1/2" HIGH, 21" DEEP

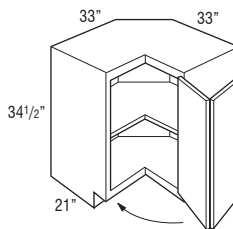

VER333421 L or R	1180	1259	1331	1402	1474	1544	1639	1704	1772	1837	1888	2045
-------------------------	------	------	------	------	------	------	------	------	------	------	------	------

- Decorative hardware screws must be countersunk to prevent scratching adjacent cabinets and face frame of VER.
- Includes one 1/2" thick fixed shelf in center of cabinet.
- Integrated soft-close hinge not included.

Custom Modifications

AUTH	CBO	CCO	CFNTO	CFP	CFRMO	CH	CMAT	CND	CW	DRWPWR	DRWTK	EXBK	EX	FB	FFD	FPEB	FTK	FTK_V	ID	INVFRM	MIP	RD	RECTK	RT	TKP	TOTSSS	VTK
•	•					•								•	•						•		•				•

Construction Upgrades

APC	PE
•	•

Door Options

ALF	CG	DPSRR	MD	MFO
		•		

**VANITY DRAWER BASE,
32" HIGH, 21" DEEP**

12", 15", 18", 21", 24",
27", 30", 33", or 36"

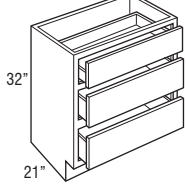

Price Point	1	2	3	4	5	6	7	8	9	10	11	12
VDB123221	1278	1285	1295	1304	1314	1323	1387	1432	1481	1521	1553	1673
VDB153221	1340	1346	1357	1369	1380	1390	1460	1505	1553	1599	1633	1756
VDB183221	1391	1398	1411	1424	1436	1448	1521	1571	1622	1672	1708	1837
VDB213221	1443	1449	1463	1476	1490	1502	1575	1631	1682	1733	1772	1904
VDB243221	1488	1496	1512	1528	1543	1559	1636	1695	1752	1800	1841	1984
VDB273221	1607	1615	1633	1651	1669	1686	1768	1829	1891	1945	1988	2143
VDB303221	1737	1746	1765	1783	1802	1820	1907	1975	2043	2101	2147	2315
VDB333221	1874	1883	1904	1925	1947	1967	2062	2132	2205	2268	2320	2501
VDB363221	2024	2034	2056	2079	2101	2122	2228	2305	2380	2451	2504	2698

Custom Modifications

AUTH	CBO	CCO	CFNTO	CFP	CFRMO	CH	CMAT	CND	CW	DRWPWR	DRWTK	EXBK	EX	FB	FFD	FPEB	FTK	FTK_V	ID	INVFRM	MIP	RD	RECTK	RT	TKP	TOTSSS	VTK
•	•	•	•	•	•	•	•	•	• ¹	• ²	• ²	•	•	•	•	•	•	•	• ¹	•	•	•	•	•	•	•	•

Construction Upgrades

APC	PE
•	•

Door Options

ALF	CG	DPSRR	MD	MFO
•	•	•	•	•

¹ Not available on 12" wide

² Not available on 12" and 15" wide

**VANITY DRAWER BASE,
34 1/2" HIGH, 21" DEEP**

12", 15", 18", 21", 24",
27", 30", 33", or 36"

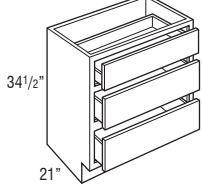

VDB123421	1294	1300	1310	1320	1331	1341	1406	1453	1496	1540	1575	1693
VDB153421	1351	1357	1369	1379	1390	1400	1467	1519	1568	1609	1645	1772
VDB183421	1425	1431	1443	1454	1465	1475	1551	1603	1655	1702	1744	1876
VDB213421	1499	1506	1520	1533	1547	1559	1636	1695	1752	1800	1841	1984
VDB243421	1578	1586	1599	1613	1626	1640	1725	1784	1845	1896	1942	2092
VDB273421	1706	1715	1729	1743	1757	1771	1863	1924	1992	2047	2099	2260
VDB303421	1841	1850	1866	1882	1897	1912	2012	2080	2153	2211	2266	2440
VDB333421	1989	1999	2016	2032	2048	2064	2172	2246	2323	2388	2448	2638
VDB363421	2148	2159	2177	2195	2213	2231	2348	2427	2510	2578	2643	2849

Custom Modifications

AUTH	CBO	CCO	CFNTO	CFP	CFRMO	CH	CMAT	CND	CW	DRWPWR	DRWTK	EXBK	EX	FB	FFD	FPEB	FTK	FTK_V	ID	INVFRM	MIP	RD	RECTK	RT	TKP	TOTSSS	VTK
•	•	•	•	•	•	•	•	•	• ¹	• ²	• ²	•	•	•	•	•	•	•	• ¹	•	•	•	•	•	•	•	•

Construction Upgrades

APC	PE
•	•

Door Options

ALF	CG	DPSRR	MD	MFO
•	•	•	•	•

¹ Not available on 12" wide

² Not available on 12" and 15" wide

**VANITY FOUR DRAWER BASE,
34 1/2" HIGH, 21" DEEP**

12", 15", 18", or 21"

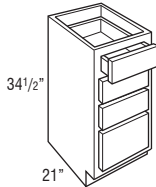

24", 27", 30", 33", or 36"

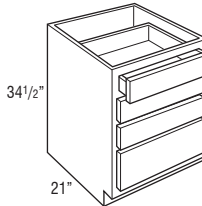

4VDB123421	1529	1537	1548	1559	1570	1581	1656	1709	1764	1810	1848	1988
4VDB153421	1597	1605	1618	1631	1643	1655	1733	1790	1848	1896	1936	2082
4VDB183421	1671	1679	1692	1706	1719	1732	1817	1874	1940	1989	2034	2188
4VDB213421	1751	1760	1774	1789	1803	1817	1904	1968	2032	2089	2135	2296
4VDB243421	1848	1857	1873	1887	1903	1917	2010	2078	2144	2206	2257	2432
4VDB273421	1997	2007	2023	2038	2054	2069	2171	2243	2317	2383	2438	2626
4VDB303421	2156	2167	2185	2202	2220	2237	2346	2424	2502	2573	2633	2836
4VDB333421	2326	2337	2356	2376	2395	2414	2536	2619	2701	2780	2844	3064
4VDB363421	2512	2524	2546	2566	2587	2607	2735	2828	2918	3002	3070	3308

Custom Modifications

AUTH	CBO	CCO	CFNTO	CFP	CFRMO	CH	CMAT	CND	CW	DRWPWR	DRWTK	EXBK	EX	FB	FFD	FPEB	FTK	FTK_V	ID	INVFRM	MIP	RD	RECTK	RT	TKP	TOTSSS	VTK
•	•	•	•	•	•	•	•	•	• ¹	• ²	• ²	•	•	•	•	•	•	•	• ¹	•	•	•	•	•	•	•	•

Construction Upgrades

APC	PE
•	•

Door Options

ALF	CG	DPSRR	MD	MFO
•	•	•	•	•

¹ Not available on 12" wide

² Not available on 12" and 15" wide

VANITY BASE WASTEBASKET, 34 1/2" HIGH, 21" DEEP

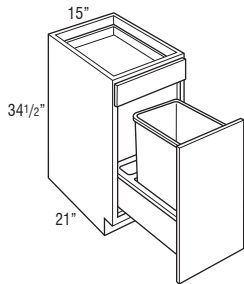

Price Point	1	2	3	4	5	6	7	8	9	10	11	12
VBWB153421	1521	1564	1574	1583	1592	1601	1652	1684	1720	1756	1780	1867

- Includes one 35 quart gray wastebasket and one trash bag storage area.
- Pull-out features undermount soft-close guides.
- Base Wastebasket Lid (BWBLID) fits 35 quart wastebaskets. See page 311.

Custom Modifications

AUTH	CBO	CCO	CFNT0	CFP	CFRMO	CH	CMAT	CND	CW	DRWPWR	DRWTK	EXBK	EX	FB	FFD	FPEB	FTK	FTK_V	ID	INVFRM	MIP	RD	RECTK_RT	TKP	TOTSSS	VTK	
•	•	•		•	•				•		•		•	•			•	•	•			•		•			•

Construction Upgrades

APC	PE
•	•

Door Options

ALF	CG	DPSRR	MD	MFO

VANITY WASTEBASKET FULL HEIGHT, 32" HIGH, 21" DEEP

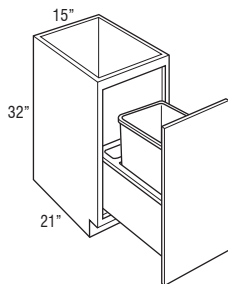

VWB153221	1210	1256	1278	1299	1320	1341	1381	1405	1434	1463	1480	1545
------------------	------	------	------	------	------	------	------	------	------	------	------	------

- Includes one 35 quart gray wastebasket and one trash bag storage area.
- Pull-out features undermount soft-close guides.
- Base Wastebasket Lid (BWBLID) fits 35 quart wastebaskets. See page 311.

Custom Modifications

AUTH	CBO	CCO	CFNT0	CFP	CFRMO	CH	CMAT	CND	CW	DRWPWR	DRWTK	EXBK	EX	FB	FFD	FPEB	FTK	FTK_V	ID	INVFRM	MIP	RD	RECTK_RT	TKP	TOTSSS	VTK	
•	•	•			•							•	•	•			•	•	•			•		•			•

Construction Upgrades

APC	PE
•	•

Door Options

ALF	CG	DPSRR	MD	MFO

VANITY WASTEBASKET FULL HEIGHT with ROLL TRAY, 32" HIGH, 21" DEEP

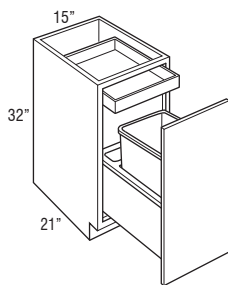

VWB153221RT	1494	1540	1562	1583	1604	1625	1665	1689	1718	1747	1764	1829
--------------------	------	------	------	------	------	------	------	------	------	------	------	------

- Includes one 35 quart gray wastebasket and one trash bag storage area.
- Pull-out features undermount soft-close guides.
- 1 roll tray standard.
- Not compatible with BWBLID due to limited height clearance.

Custom Modifications

AUTH	CBO	CCO	CFNT0	CFP	CFRMO	CH	CMAT	CND	CW	DRWPWR	DRWTK	EXBK	EX	FB	FFD	FPEB	FTK	FTK_V	ID	INVFRM	MIP	RD	RECTK_RT	TKP	TOTSSS	VTK	
•	•	•			•							•	•	•			•	•	•			•		•			•

Construction Upgrades

APC	PE
•	•

Door Options

ALF	CG	DPSRR	MD	MFO

VANITY WASTEBASKET FULL HEIGHT, 34 1/2" HIGH, 21" DEEP

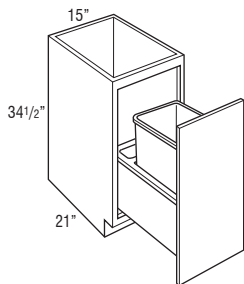

VWB153421	1251	1292	1316	1339	1363	1386	1423	1453	1482	1512	1534	1606
------------------	------	------	------	------	------	------	------	------	------	------	------	------

- Includes one 35 quart gray wastebasket and one trash bag storage area.
- Pull-out features undermount soft-close guides.
- Base Wastebasket Lid (BWBLID) fits 35 quart wastebaskets. See page 311.

Custom Modifications

AUTH	CBO	CCO	CFNT0	CFP	CFRMO	CH	CMAT	CND	CW	DRWPWR	DRWTK	EXBK	EX	FB	FFD	FPEB	FTK	FTK_V	ID	INVFRM	MIP	RD	RECTK_RT	TKP	TOTSSS	VTK	
•	•	•			•							•	•	•			•	•	•			•		•			•

Construction Upgrades

APC	PE
•	•

Door Options

ALF	CG	DPSRR	MD	MFO

Price Point

1 2 3 4 5 6 7 8 9 10 11 12

VANITY WASTEBASKET FULL HEIGHT with ROLL TRAY, 34 1/2" HIGH, 21" DEEP

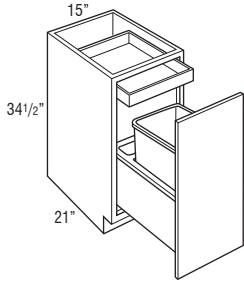

VWB153421RT	1535	1576	1600	1623	1647	1670	1707	1737	1766	1796	1818	1890
-------------	------	------	------	------	------	------	------	------	------	------	------	------

- Includes one 35 quart gray wastebasket and one trash bag storage area.
- Pull-out features undermount soft-close guides.
- 1 roll tray standard.
- Base Wastebasket Lid (BWBLID) fits 35 quart wastebaskets. See page 311.

Custom Modifications

AUTH	CBO	CCO	CFNT0	CFP	CFRMO	CH	CMAT	CND	CW	DRWPWR	DRWTK	EXBK	EX	FB	FFD	FPEB	FTK	FTK_V	ID	INVFRM	MIP	RD	RECTK_	RT	TKP	TOTSSS	VTK	
•	•	•			•							•	•	•		•	•	•				•		•				•

Construction Upgrades

APC	PE
•	•

Door Options

ALF	CG	DPSRR	MD	MFO

VANITY PULL-OUT, 34 1/2" HIGH, 21" DEEP

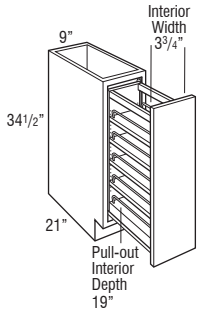

VP93421	1029	1042	1073	1104	1136	1166	1238	1289	1338	1385	1421	1541
---------	------	------	------	------	------	------	------	------	------	------	------	------

- Natural Finish with soft-close full extension wood pull-out with adjustable shelves and chrome rail sides.
- Pull-out is 19 9/16" deep.

Custom Modifications

AUTH	CBO	CCO	CFNT0	CFP	CFRMO	CH	CMAT	CND	CW	DRWPWR	DRWTK	EXBK	EX	FB	FFD	FPEB	FTK	FTK_V	ID	INVFRM	MIP	RD	RECTK_	RT	TKP	TOTSSS	VTK	
•	•	•			•							•	•	•		•	•					•		• ¹				•

Construction Upgrades

APC	PE
•	•

Door Options

ALF	CG	DPSRR	MD	MFO
		•		

¹ RECTKALL not available

VANITY GROOMING PULL-OUT, 34 1/2" HIGH, 21" DEEP

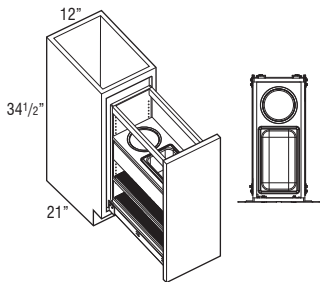

VGPO123421	2170	2190	2223	2255	2288	2320	2394	2448	2503	2555	2591	2720
------------	------	------	------	------	------	------	------	------	------	------	------	------

- Natural Finish with soft-close full extension wood pull-out with adjustable shelves.
- Pull-out is 19 9/16" deep.
- Features adjustable shelves with non-skid vinyl liners and clear polycarbonate rails.
- Includes two stainless steel bins (one rectangular and one round) for storing items such as curling irons and hair dryers.

Custom Modifications

AUTH	CBO	CCO	CFNT0	CFP	CFRMO	CH	CMAT	CND	CW	DRWPWR	DRWTK	EXBK	EX	FB	FFD	FPEB	FTK	FTK_V	ID	INVFRM	MIP	RD	RECTK_	RT	TKP	TOTSSS	VTK	
•	•	•			•							•	•	•		•	•					•		•				•

Construction Upgrades

APC	PE
•	•

Door Options

ALF	CG	DPSRR	MD	MFO
		•		

**VANITY SINK DRAWER BASE,
32" HIGH, 21" DEEP**

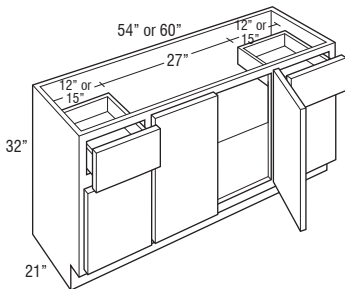
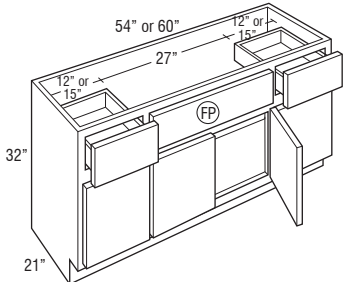
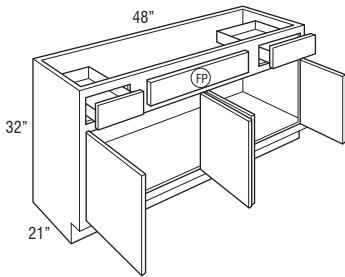
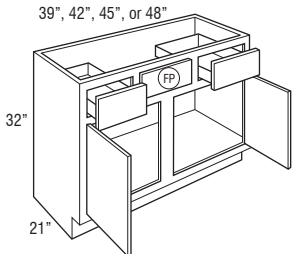
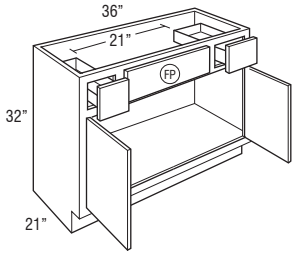

FP = False Panel

Price Point

	1	2	3	4	5	6	7	8	9	10	11	12
2VSD363221	1388	1430	1446	1460	1476	1491	1570	1625	1682	1736	1780	1921
2VSD393221	1418	1497	1514	1530	1546	1561	1645	1704	1764	1819	1865	2013
2VSD423221	1449	1564	1580	1597	1614	1631	1719	1782	1846	1903	1950	2106
2VSD453221	1514	1639	1652	1664	1677	1689	1781	1846	1914	1975	2023	2184
2VSD483221CS	1583	1711	1720	1729	1738	1746	1844	1911	1979	2043	2091	2259
2VSD483221	1668	1835	1854	1872	1889	1907	1967	2038	2112	2183	2237	2414
2VSD543221FP	2056	2262	2297	2332	2367	2400	2537	2633	2726	2817	2886	3121
2VSD603221FP	2219	2440	2486	2531	2576	2621	2773	2874	2977	3082	3158	3417
2VSD543221	1851	2036	2055	2074	2093	2112	2230	2314	2396	2475	2537	2742
2VSD603221	1988	2187	2216	2246	2275	2304	2433	2526	2617	2704	2773	2993

	Face Frame Opening Width			Available Sink Clearance Width	# of Sink Openings	# of Drawers
	Drawers	Side Doors	False Panel			
2VSD36...	6"	33" (butt doors)	15"	21"	1	2
2VSD39...	9"	16 1/2"	12"	18"	1	2
2VSD42...	9"	18"	15"	21"	1	2
2VSD45...	9"	19 1/2"	18"	24"	1	2
2VSD48...CS	12"	21"	15"	21"	1	2
2VSD48...	12"	21"	15"	21"	1	2
2VSD54...	12"	12"	21"	27"	1	2
2VSD60...	15"	15"	21"	27"	1	2

Custom Modifications

AUTH	CBO	CCO	CFNTO	CFP	CFRMO	CH	CMAT	CND	CW	DRWPWR	DRWTK	EXBK	EX	FB	FFD	FPEB	FTK	FTK_V	ID	INVFRM	MIP	RD	RECTK	RT	TKP	TOTSSS	VTK
•	•	•	•	•	•	•	• ¹	•	• ²	• ³	•	•	•	•	•	•	•	•	•	•	•	•	•	• ⁴	•	• ⁵	•

Construction Upgrades

APC	PE
•	•

Door Options

ALF	CG	DPSRR	MD	MFO
•	•	•	•	•

- ¹ Not available on 39", 42", and 45" wide
- ² Available only on 60" wide
- ³ Available only on 36" wide
- ⁴ Available only on 36", 39", 42", 45", and 48" wide
- ⁵ Available only on cabinets with false panels

**VANITY SINK DRAWER BASE,
34 1/2" HIGH, 21" DEEP**

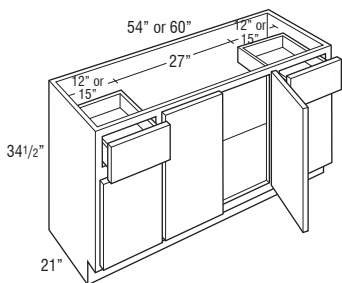
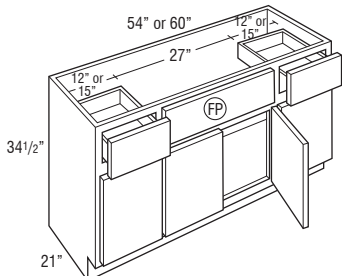
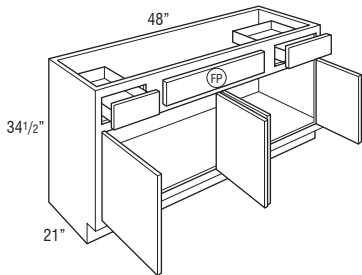
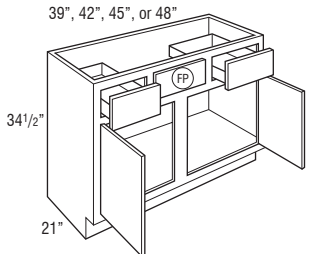
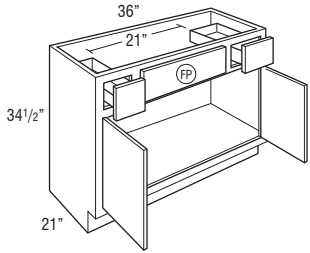

FP = False Panel

Price Point

	1	2	3	4	5	6	7	8	9	10	11	12
2VSD363421	1537	1614	1633	1651	1669	1687	1776	1841	1910	1967	2015	2176
2VSD393421	1570	1701	1718	1734	1749	1765	1861	1929	1999	2063	2113	2281
2VSD423421	1605	1788	1802	1817	1831	1845	1947	2016	2088	2159	2210	2387
2VSD453421	1682	1860	1874	1886	1900	1912	2018	2091	2165	2239	2293	2476
2VSD483421CS	1760	1933	1945	1957	1969	1980	2088	2165	2241	2318	2374	2565
2VSD483421	1851	2036	2056	2075	2094	2113	2231	2315	2398	2476	2538	2743
2VSD543421FP	2296	2526	2577	2628	2678	2728	2883	2993	3104	3208	3291	3556
2VSD603421FP	2477	2725	2790	2854	2919	2983	3155	3274	3394	3513	3601	3892
2VSD543421	2056	2262	2296	2330	2363	2396	2532	2626	2723	2815	2883	3118
2VSD603421	2218	2439	2484	2528	2573	2616	2768	2869	2974	3079	3155	3410

	Face Frame Opening Width			Available Sink Clearance Width	# of Sink Openings	# of Drawers
	Drawers	Side Doors	False Panel			
2VSD36...	6"	33" (butt doors)	15"	21"	1	2
2VSD39...	9"	16 1/2"	12"	18"	1	2
2VSD42...	9"	18"	15"	21"	1	2
2VSD45...	9"	19 1/2"	18"	24"	1	2
2VSD48...CS	12"	21"	15"	21"	1	2
2VSD48...	12"	21"	15"	21"	1	2
2VSD54...	12"	12"	21"	27"	1	2
2VSD60...	15"	15"	21"	27"	1	2

Custom Modifications

AUTH	CBO	CCO	CFNTO	CFP	CFRMO	CH	CMAT	CND	CW	DRWPWR	DRWTK	EXBK	EX	FB	FFD	FPEB	FTK	FTK_V	ID	INVFRM	MIP	RD	RECTK	RT	TKP	TOTSSS	VTK
•	•	•	•	•	•	•	• ¹	•	• ²	• ³	•	•	•	•	•	•	•	•	•	•	•	•	•	• ⁴	•	• ⁵	•

Construction Upgrades

APC	PE
•	•

Door Options

ALF	CG	DPSRR	MD	MFO
•	•	•	•	•

¹ Not available on 39", 42", and 45" wide

² Available only on 60" wide

³ Available only on 36" wide

⁴ Available only on 36", 39", 42", 45", and 48" wide

⁵ Available only on cabinets with false panels

**VANITY SINK DRAWER BASE,
32" HIGH, 21" DEEP**

24", 27", 30", or 33"

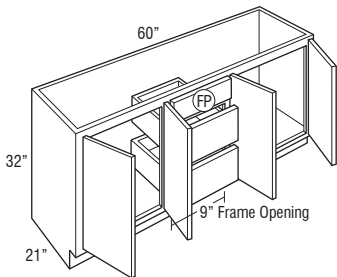
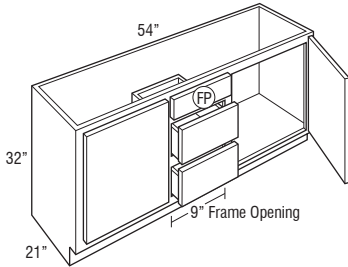
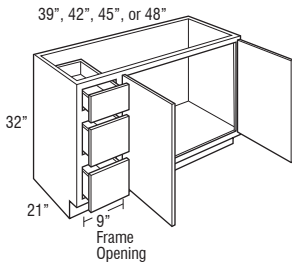
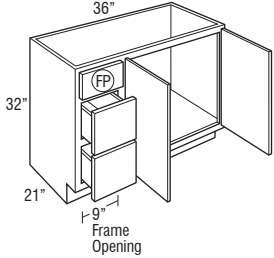
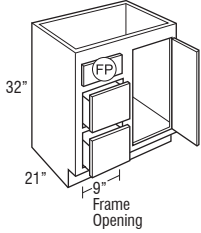

FP = False Panel

Price
Point

	1	2	3	4	5	6	7	8	9	10	11	12
VSD243221 DL or DR	1276	1335	1350	1363	1376	1390	1465	1520	1572	1622	1659	1790
VSD273221 DL or DR	1303	1368	1382	1397	1411	1425	1501	1556	1609	1659	1699	1835
VSD303221 DL or DR	1332	1399	1415	1430	1446	1462	1534	1592	1649	1698	1742	1877
VSD333221 DL or DR	1403	1496	1513	1529	1544	1560	1642	1705	1765	1819	1866	2012

VSD363221 DL or DR	1476	1596	1613	1628	1645	1661	1752	1818	1880	1940	1991	2147
---------------------------	------	------	------	------	------	------	------	------	------	------	------	------

VSD393221 DL or DR	1607	1683	1700	1717	1734	1751	1845	1912	1979	2040	2091	2253
---------------------------	------	------	------	------	------	------	------	------	------	------	------	------

VSD423221 DL or DR	1738	1770	1788	1805	1823	1840	1938	2007	2076	2138	2188	2360
---------------------------	------	------	------	------	------	------	------	------	------	------	------	------

VSD453221 DL or DR	1771	1814	1833	1851	1870	1888	1987	2057	2128	2193	2244	2419
---------------------------	------	------	------	------	------	------	------	------	------	------	------	------

VSD483221 DL or DR	1801	1858	1878	1897	1916	1935	2034	2107	2177	2247	2299	2479
---------------------------	------	------	------	------	------	------	------	------	------	------	------	------

VSD5543221FH	1823	1986	1996	2005	2014	2023	2130	2206	2284	2356	2415	2605
---------------------	------	------	------	------	------	------	------	------	------	------	------	------

VSD5603221FH	1844	2028	2048	2069	2089	2108	2222	2303	2391	2466	2530	2731
---------------------	------	------	------	------	------	------	------	------	------	------	------	------

- DL or DR indicates drawer location.
- CFP is available on 39", 42", 45", and 48" widths, but standard on all other widths.

	Face Frame Opening Width		Available Sink Clearance Width	# of Sink Openings	# of Drawers
	Drawers	Doors			
VSD24...	9"	9"	21"	1	2
VSD27...	9"	12"	24"	1	2
VSD30...	9"	15"	27"	1	2
VSD33...	9"	18"	30"	1	2
VSD36...	9"	21"	33"	1	2
VSD39...	9"	24"	27"	1	3
VSD42...	9"	27"	30"	1	3
VSD45...	9"	30"	33"	1	3
VSD48...	9"	33"	36"	1	3
VSD554...	9"	18"	21"	2	2
VSD560...	9"	21"	24"	2	2

Custom Modifications

AUTH	CBO	CCO	CFNTO	CFP	CFRMO	CH	CMAT	CND	CW	DRWPWR	DRWTK	EXBK	EX	FB	FFD	FPEB	FTK	FTK_V	ID	INVFRM	MIP	RD	RECTK	RT	TKP	TOTSSS	VTK
•	•	•	•	•	•	•	•	•	•	•	• ²	•	•	•	•	•	•	•	•	•	•	•	•	•	•	•	•

Construction Upgrades

APC	PE
•	•

Door Options

ALF	CG	DPSRR	MD	MFO
•	•	•	•	•

¹ Not available on 24", 27", 30", 33", and 60" wide
² Not available on 39", 42", 45", 48", 54", and 60" wide

**VANITY SINK DRAWER BASE,
34 1/2" HIGH, 21" DEEP**

24", 27", 30", or 33"

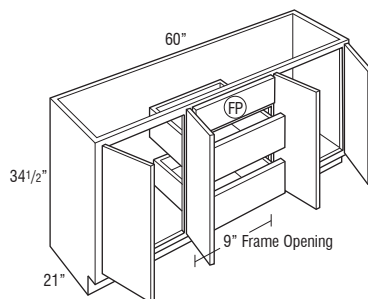
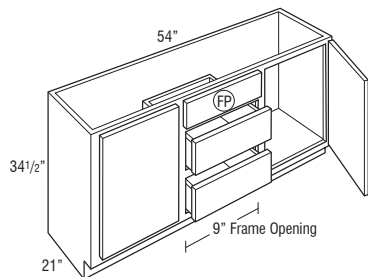
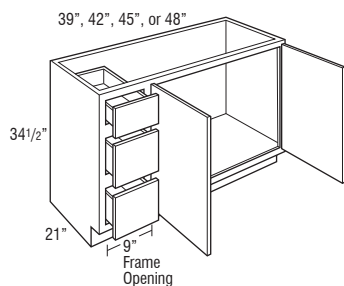
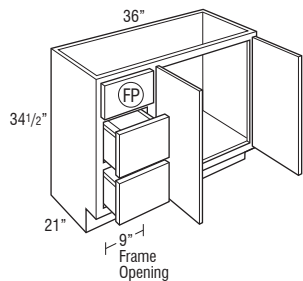
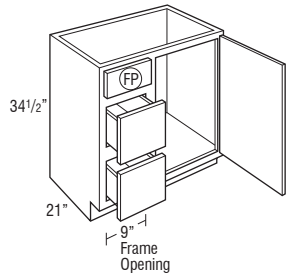

(FP) = False Panel

Price Point

	1	2	3	4	5	6	7	8	9	10	11	12
VSD243421 DL or DR	1409	1509	1525	1541	1557	1572	1658	1715	1774	1835	1877	2025
VSD273421 DL or DR	1439	1546	1562	1579	1596	1613	1699	1760	1820	1882	1928	2079
VSD303421 DL or DR	1472	1586	1603	1618	1634	1650	1742	1803	1866	1929	1975	2132
VSD333421 DL or DR	1555	1726	1736	1745	1755	1764	1859	1924	1998	2060	2112	2279

VSD363421 DL or DR	1640	1864	1867	1869	1873	1875	1978	2048	2127	2192	2247	2427
---------------------------	------	------	------	------	------	------	------	------	------	------	------	------

VSD393421 DL or DR	1775	1924	1936	1949	1961	1972	2079	2154	2232	2300	2354	2541
---------------------------	------	------	------	------	------	------	------	------	------	------	------	------

VSD423421 DL or DR	1910	1986	2007	2027	2047	2068	2177	2257	2337	2408	2462	2657
---------------------------	------	------	------	------	------	------	------	------	------	------	------	------

VSD453421 DL or DR	1945	2040	2062	2083	2104	2126	2239	2320	2400	2474	2532	2731
---------------------------	------	------	------	------	------	------	------	------	------	------	------	------

VSD483421 DL or DR	1981	2092	2116	2138	2162	2184	2298	2382	2463	2541	2603	2807
---------------------------	------	------	------	------	------	------	------	------	------	------	------	------

VSDS543421FH	2022	2230	2244	2259	2274	2288	2412	2500	2591	2673	2742	2958
---------------------	------	------	------	------	------	------	------	------	------	------	------	------

VSDS603421FH	2061	2367	2373	2379	2384	2390	2523	2619	2718	2806	2877	3109
---------------------	------	------	------	------	------	------	------	------	------	------	------	------

- DL or DR indicates drawer location.
- CFP is available on 39", 42", 45", and 48" widths, but standard on all other widths.

	Face Frame Opening Width		Available Sink Clearance Width	# of Sink Openings	# of Drawers
	Drawers	Doors			
VSD24...	9"	9"	21"	1	2
VSD27...	9"	12"	24"	1	2
VSD30...	9"	15"	27"	1	2
VSD33...	9"	18"	30"	1	2
VSD36...	9"	21"	33"	1	2
VSD39...	9"	24"	27"	1	3
VSD42...	9"	27"	30"	1	3
VSD45...	9"	30"	33"	1	3
VSD48...	9"	33"	36"	1	3
VSDS54...	9"	18"	21"	2	2
VSDS60...	9"	21"	24"	2	2

Custom Modifications

AUTH	CBO	CCO	CFNT0	CFP	CFRMO	CH	CMAT	CND	CW	DRWPWR	DRWTK	EXBK	EX	FB	FFD	FPEB	FTK	FTK_V	ID	INVRM	MIP	RD	RECTK	RT	TKP	TOTSSS	VTK
•	•	•		STD	•			1	•		2	•	•	•	•	•	•	•	•	•	•	•	•	•	•	•	•

Construction Upgrades

APC	PE
•	•

Door Options

ALF	CG	DPSRR	MD	MFO
		•		

¹ Not available on 24", 27", 30", 33", and 60" wide
² Not available on 39", 42", 45", 48", 54", and 60" wide

VANITY SINK DRAWER BASE with FALSE PANEL, 32" HIGH, 21" DEEP

24", 27", 30", or 33"

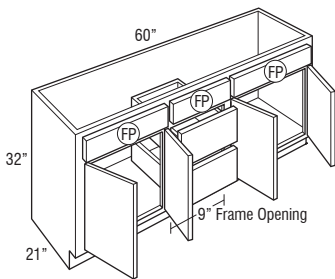
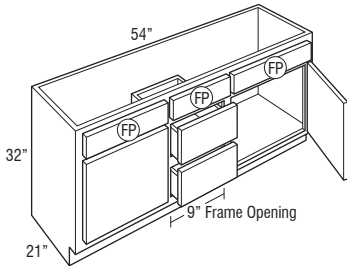
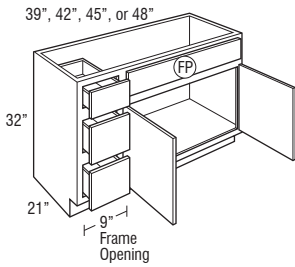
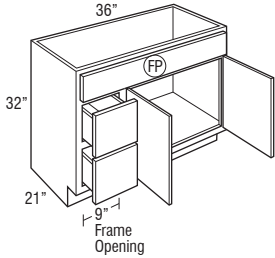
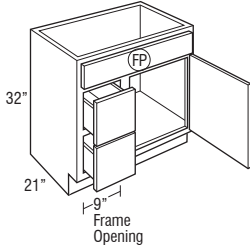

FP = False Panel

Price Point	1	2	3	4	5	6	7	8	9	10	11	12
VSD243221FP DL or DR	1408	1510	1525	1541	1557	1572	1658	1718	1781	1836	1880	2027
VSD273221FP DL or DR	1439	1546	1562	1578	1595	1611	1698	1761	1823	1882	1929	2080
VSD303221FP DL or DR	1472	1585	1602	1617	1633	1649	1738	1803	1865	1928	1975	2132
VSD333221FP DL or DR	1553	1725	1736	1747	1758	1768	1864	1933	2003	2064	2117	2288

VSD363221FP DL or DR	1637	1863	1869	1875	1880	1886	1989	2064	2135	2203	2260	2440
----------------------	------	------	------	------	------	------	------	------	------	------	------	------

VSD393221FP DL or DR	1774	1930	1943	1956	1969	1981	2089	2165	2240	2309	2368	2555
VSD423221FP DL or DR	1910	1996	2016	2036	2056	2075	2187	2266	2345	2416	2475	2669
VSD453221FP DL or DR	1945	2045	2066	2088	2109	2130	2243	2323	2406	2480	2540	2736
VSD483221FP DL or DR	1981	2092	2116	2139	2163	2185	2298	2382	2463	2544	2604	2808

VSDS543221FP	2022	2231	2247	2261	2276	2290	2414	2502	2592	2676	2743	2960
--------------	------	------	------	------	------	------	------	------	------	------	------	------

VSDS603221FP	2061	2369	2376	2382	2389	2395	2529	2623	2722	2808	2880	3112
--------------	------	------	------	------	------	------	------	------	------	------	------	------

- DL or DR indicates drawer location.
- CFP is available on 39", 42", 45", and 48" widths, but standard on all other widths.

	Face Frame Opening Width		Available Sink Clearance Width	# of Sink Openings	# of Drawers
	Drawers	Doors			
VSD24...	9"	9"	21"	1	2
VSD27...	9"	12"	24"	1	2
VSD30...	9"	15"	27"	1	2
VSD33...	9"	18"	30"	1	2
VSD36...	9"	21"	33"	1	2
VSD39...	9"	24"	27"	1	3
VSD42...	9"	27"	30"	1	3
VSD45...	9"	30"	33"	1	3
VSD48...	9"	33"	36"	1	3
VSDS54...	9"	18"	21"	2	2
VSDS60...	9"	21"	24"	2	2

Custom Modifications

AUTH	CBO	CCO	CFNTO	CFP	CFRMO	CH	CMAT	CND	CW	DRWPWR	DRWTK	EXBK	EX	FB	FFD	FPEB	FTK	FTK_V	ID	INFRM	MIP	RD	RECTK	RT	TKP	TOTSSS	VTK
•	•	•	•	•	•	•	•	•	•	•	• ²	•	•	•	•	•	•	•	•	•	•	•	•	•	•	•	•

Construction Upgrades

APC	PE
•	•

Door Options

ALF	CG	DPSRR	MD	MFO
•	•	•	•	•

¹ Not available on 24", 27", 30", 33", and 60" wide
² Not available on 39", 42", 45", 48", 54", and 60" wide

VANITY SINK DRAWER BASE with FALSE PANEL, 34 1/2" HIGH, 21" DEEP

24", 27", 30", or 33"

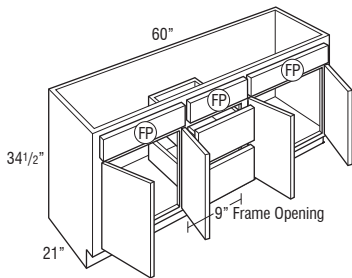
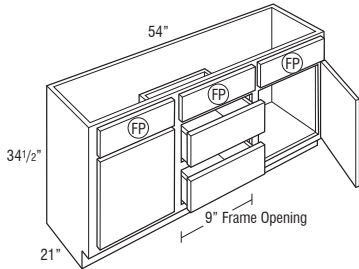
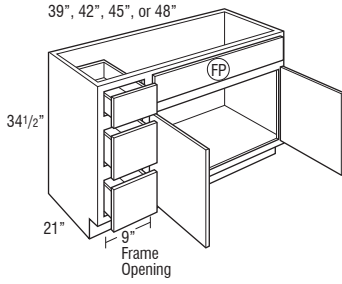
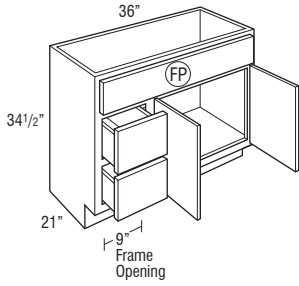
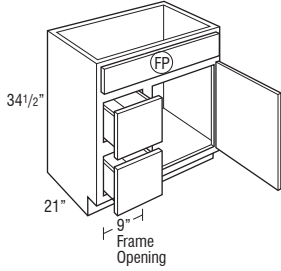

FP = False Panel

Price Point

	1	2	3	4	5	6	7	8	9	10	11	12
VSD243421FP DL or DR	1558	1732	1744	1756	1768	1781	1878	1947	2016	2081	2132	2299
VSD273421FP DL or DR	1596	1791	1801	1810	1819	1828	1928	1996	2070	2135	2187	2361
VSD303421FP DL or DR	1632	1851	1857	1863	1868	1874	1975	2046	2124	2188	2243	2423
VSD333421FP DL or DR	1729	1968	1977	1985	1992	2000	2111	2188	2268	2341	2399	2594

VSD363421FP DL or DR	1826	2084	2096	2107	2118	2128	2246	2328	2415	2492	2558	2763
----------------------	------	------	------	------	------	------	------	------	------	------	------	------

VSD393421FP DL or DR	1966	2164	2182	2199	2216	2233	2354	2439	2529	2608	2676	2886
----------------------	------	------	------	------	------	------	------	------	------	------	------	------

VSD423421FP DL or DR	2107	2242	2267	2290	2314	2337	2463	2549	2642	2726	2791	3011
----------------------	------	------	------	------	------	------	------	------	------	------	------	------

VSD453421FP DL or DR	2149	2346	2362	2377	2391	2406	2532	2623	2718	2803	2871	3098
----------------------	------	------	------	------	------	------	------	------	------	------	------	------

VSD483421FP DL or DR	2190	2449	2455	2460	2465	2470	2602	2695	2790	2878	2950	3185
----------------------	------	------	------	------	------	------	------	------	------	------	------	------

VSD5543421FP	2250	2556	2567	2577	2587	2597	2741	2837	2943	3039	3117	3367
--------------	------	------	------	------	------	------	------	------	------	------	------	------

VSDS603421FP	2309	2664	2679	2694	2708	2723	2876	2979	3097	3199	3284	3549
--------------	------	------	------	------	------	------	------	------	------	------	------	------

- DL or DR indicates drawer location.
- CFP is available on 39", 42", 45", and 48" widths, but standard on all other widths.

	Face Frame Opening Width		Available Sink Clearance Width	# of Sink Openings	# of Drawers
	Drawers	Doors			
VSD24...	9"	9"	21"	1	2
VSD27...	9"	12"	24"	1	2
VSD30...	9"	15"	27"	1	2
VSD33...	9"	18"	30"	1	2
VSD36...	9"	21"	33"	1	2
VSD39...	9"	24"	27"	1	3
VSD42...	9"	27"	30"	1	3
VSD45...	9"	30"	33"	1	3
VSD48...	9"	33"	36"	1	3
VSDS54...	9"	18"	21"	2	2
VSDS60...	9"	21"	24"	2	2

Custom Modifications

AUTH	CBO	CCO	CFNTO	CFP	CFRMO	CH	CMAT	CND	CW	DRWPWR	DRWTK	EXBK	EX	FB	FFD	FPEB	FTK	FTK_V	ID	INVFRM	MIP	RD	RECTK	RT	TKP	TOTSSS	VTK
•	•	•	•	STD	•	•	• ¹	•	•	•	• ²	•	•	•	•	•	•	•	•	•	•	•	•	•	•	•	•

Construction Upgrades

APC	PE
•	•

Door Options

ALF	CG	DPSRR	MD	MFO
•	•	•	•	•

¹ Not available on 24", 27", 30", 33", and 60" wide
² Not available on 39", 42", 45", 48", 54", and 60" wide

VANITY SINK WIDE DRAWER BASE with FALSE PANELS, 32" HIGH, 21" DEEP

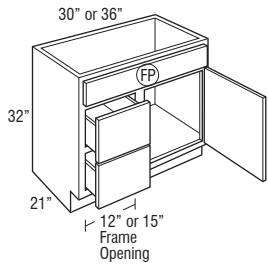

FP = False Panel

Price Point	1	2	3	4	5	6	7	8	9	10	11	12
VSWD303221FP DL or DR	1472	1585	1602	1617	1633	1649	1738	1803	1865	1928	1975	2132
VSWD363221FP DL or DR	1637	1863	1869	1875	1880	1886	1989	2064	2135	2203	2260	2440

• DL or DR indicates drawer location.

	Face Frame Opening Width		Available Sink Clearance Width	# of Sink Openings	# of Drawers
	Drawers	Doors			
VSWD30..	12"	12"	27"	1	2
VSWD36..	15"	15"	33"	1	2

Custom Modifications

AUTH	CBO	CCO	CFNTO	CFP	CFRMO	CH	CMAT	CND	CW	DRWPWR	DRWTK	EXBK	EX	FB	FFD	FPEB	FTK	FTK_V	ID	INVFRM	MIP	RD	RECTK	RT	TKP	TOTSSS	VTK
•	•	•		STD	•			•			•	•	•	•	•	•	•	•	•		•	•	•			•	•

Construction Upgrades

APC	PE
•	•

Door Options

ALF	CG	DPSRR	MD	MFO
		•		

VANITY SINK WIDE DRAWER BASE with FALSE PANELS, 34 1/2" HIGH, 21" DEEP

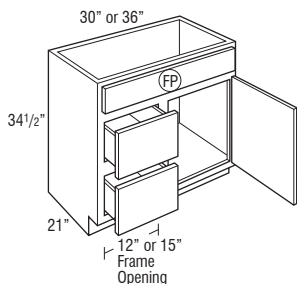

FP = False Panel

VSWD303421FP DL or DR	1632	1851	1857	1863	1868	1874	1975	2046	2124	2188	2243	2423
VSWD363421FP DL or DR	1826	2084	2096	2107	2118	2128	2246	2328	2415	2492	2558	2763

• DL or DR indicates drawer location.

	Face Frame Opening Width		Available Sink Clearance Width	# of Sink Openings	# of Drawers
	Drawers	Doors			
VSWD30..	12"	12"	27"	1	2
VSWD36..	15"	15"	33"	1	2

Custom Modifications

AUTH	CBO	CCO	CFNTO	CFP	CFRMO	CH	CMAT	CND	CW	DRWPWR	DRWTK	EXBK	EX	FB	FFD	FPEB	FTK	FTK_V	ID	INVFRM	MIP	RD	RECTK	RT	TKP	TOTSSS	VTK
•	•	•		STD	•			•			•	•	•	•	•	•	•	•	•		•	•	•			•	•

Construction Upgrades

APC	PE
•	•

Door Options

ALF	CG	DPSRR	MD	MFO
		•		

VANITY SINK THREE DRAWER BASE, 32" HIGH, 21" DEEP

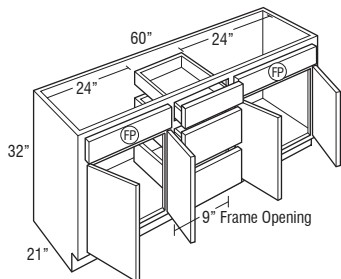
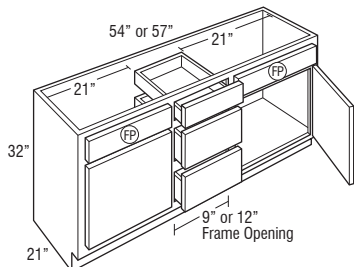

FP = False Panel

VSDS543221	2264	2473	2488	2501	2514	2528	2653	2744	2834	2914	2981	3201
VSDS573221	2284	2542	2552	2563	2572	2580	2712	2804	2899	2980	3051	3276

VSDS603221	2303	2612	2617	2623	2629	2633	2769	2864	2962	3046	3119	3350
------------	------	------	------	------	------	------	------	------	------	------	------	------

	Face Frame Opening Width		Available Sink Clearance Width	# of Sink Openings	# of Drawers
	Drawers	Doors			
VSDS54...	9"	18"	21"	2	3
VSDS57...	12"	18"	21"	2	3
VSDS60...	9"	21"	24"	2	3

Custom Modifications

AUTH	CBO	CCO	CFNTO	CFP	CFRMO	CH	CMAT	CND	CW	DRWPWR	DRWTK	EXBK	EX	FB	FFD	FPEB	FTK	FTK_V	ID	INVFRM	MIP	RD	RECTK	RT	TKP	TOTSSS	VTK
•	•	•		•	•			•			•	•	•	•	•	•	•	•	•		•	•	•			•	•

Construction Upgrades

APC	PE
•	•

Door Options

ALF	CG	DPSRR	MD	MFO
		•		

**VANITY SINK THREE DRAWER BASE,
34 1/2" HIGH, 21" DEEP**

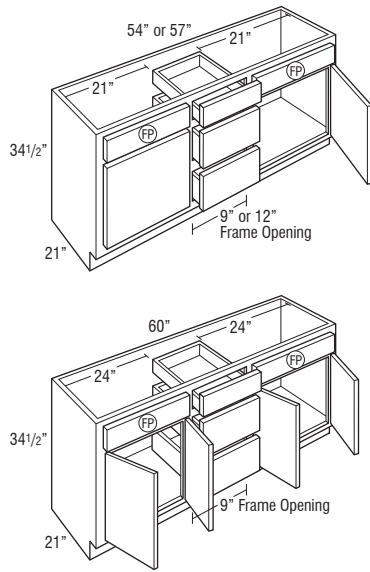

FP = False Panel

**VANITY SINK DRAWER BASE with
SIX DRAWERS, 32" HIGH,
21" DEEP**

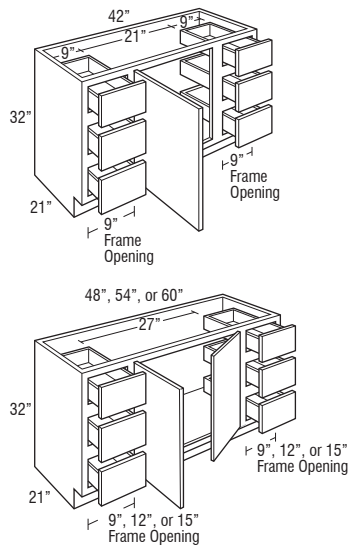

FP = False Panel

Price Point

	1	2	3	4	5	6	7	8	9	10	11	12
VSDS543421	2490	2799	2808	2817	2826	2835	2978	3079	3185	3277	3357	3606
VSDS573421	2520	2853	2864	2875	2887	2899	3048	3149	3261	3358	3440	3697
VSDS603421	2549	2905	2920	2933	2948	2961	3116	3220	3338	3437	3522	3788

	Face Frame Opening Width		Available Sink Clearance Width	# of Sink Openings	# of Drawers
	Drawers	Doors			
VSDS54...	9"	18"	21"	2	3
VSDS57...	12"	18"	21"	2	3
VSDS60...	9"	21"	24"	2	3

Custom Modifications

AUTH	CBO	CCO	CFNTO	CFP	CFRMO	CH	CMAT	CND	CW	DRWPWR	DRWTK	EXBK	EX	FB	FFD	FPEB	FTK	FTK_V	ID	INVFRM	MIP	RD	RECTK	RT	TKP	TOTSSS	VTK
•	•	•	•	•	•	•	•	•	•	•	•	•	•	•	•	•	•	•	•	•	•	•	•	•	•	•	•

Construction Upgrades

APC	PE
•	•

Door Options

ALF	CG	DPSRR	MD	MFO
•	•	•	•	•

6VSD423221 L or R	2460	2484	2501	2518	2535	2550	2670	2756	2847	2922	2990	3217
6VSD483221	2587	2613	2631	2648	2666	2682	2812	2905	2999	3082	3153	3392
6VSD543221	2717	2744	2763	2781	2799	2817	2956	3054	3154	3242	3315	3571
6VSD603221	2844	2872	2892	2911	2931	2950	3097	3203	3307	3401	3478	3745

	Face Frame Opening Width		Available Sink Clearance Width	# of Sink Openings	# of Drawers
	Drawers	Doors			
6VSD42...	9"	15"	21"	1	6
6VSD48...	9"	21"	27"	1	6
6VSD54...	12"	21"	27"	1	6
6VSD60...	15"	21"	27"	1	6

Custom Modifications

AUTH	CBO	CCO	CFNTO	CFP	CFRMO	CH	CMAT	CND	CW	DRWPWR	DRWTK	EXBK	EX	FB	FFD	FPEB	FTK	FTK_V	ID	INVFRM	MIP	RD	RECTK	RT	TKP	TOTSSS	VTK
•	•	•	•	•	•	•	• ¹	•	•	• ²	•	•	•	•	•	•	•	•	•	•	•	•	•	•	•	•	•

Construction Upgrades

APC	PE
•	•

Door Options

ALF	CG	DPSRR	MD	MFO
•	•	•	•	•

¹ Not available on 42" wide

² Available only on 60" wide

VANITY SINK DRAWER BASE with SIX DRAWERS, 34 1/2" HIGH, 21" DEEP

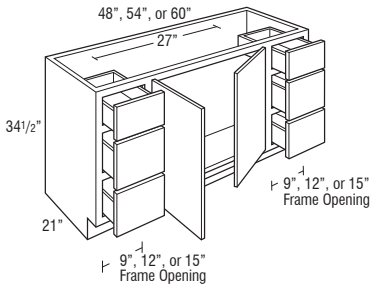
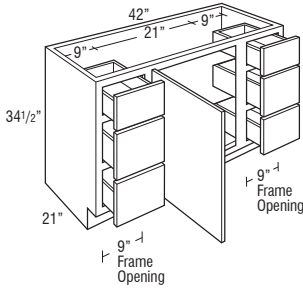

	Price Point	1	2	3	4	5	6	7	8	9	10	11	12
6VSD423421 L or R		2748	2776	2794	2811	2829	2846	2986	3087	3193	3277	3350	3606
6VSD483421		2892	2921	2941	2960	2979	2998	3147	3256	3367	3461	3537	3809
6VSD543421		3037	3068	3089	3110	3132	3153	3311	3424	3540	3643	3726	4012
6VSD603421		3182	3213	3237	3260	3284	3306	3473	3592	3713	3827	3912	4216

	Face Frame Opening Width		Available Sink Clearance Width	# of Sink Openings	# of Drawers
	Drawers	Doors			
6VSD42...	9"	15"	21"	1	6
6VSD48...	9"	21"	27"	1	6
6VSD54...	12"	21"	27"	1	6
6VSD60...	15"	21"	27"	1	6

Custom Modifications

AUTH	CBO	CCO	CFNT0	CFP	CFRMO	CH	CMAT	CND	CW	DRWPWR	DRWTK	EXBK	EX	FB	FFD	FPEB	FTK	FTK_V	ID	INVFRM	MIP	RD	RECTK	RT	TKP	TOTSSS	VTK
•	•	•	•	•	•	•	•	• ¹	•	• ²	•	•	•	•	•	•	•	•	•	•	•	•	•	•	•	•	•

Construction Upgrades

APC	PE
•	•

Door Options

ALF	CG	DPSRR	MD	MFO
•	•	•	•	•

¹ Not available on 42" wide

² Available only on 60" wide

VANITY SINK DRAWER BASE with SIX DRAWERS & FALSE PANEL, 32" HIGH, 21" DEEP

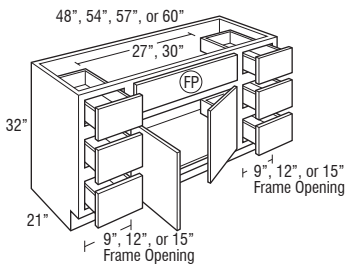
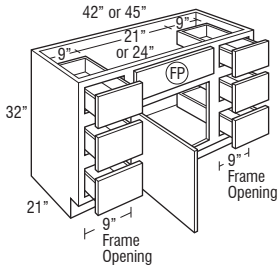

6VSD423221FP L or R	2748	2776	2794	2812	2830	2848	2988	3087	3193	3278	3356	3613
6VSD453221FP L or R	2821	2849	2868	2887	2906	2924	3070	3173	3280	3371	3448	3715
6VSD483221FP	2893	2922	2942	2961	2981	3000	3152	3258	3368	3464	3541	3817
6VSD543221FP	3040	3070	3091	3112	3134	3155	3315	3428	3543	3647	3731	4016
6VSD573221FP	3093	3114	3144	3173	3203	3232	3397	3515	3630	3740	3825	4118
6VSD603221FP	3185	3217	3240	3263	3286	3308	3479	3600	3717	3832	3919	4220

	Face Frame Opening Width		Available Sink Clearance Width	# of Sink Openings	# of Drawers
	Drawers	Doors			
6VSD42...	9"	15"	21"	1	6
6VSD45...	9"	18"	24"	1	6
6VSD48...	9"	21"	27"	1	6
6VSD54...	12"	21"	27"	1	6
6VSD57...	12"	24"	30"	1	6
6VSD60...	15"	21"	27"	1	6

Custom Modifications

AUTH	CBO	CCO	CFNT0	CFP	CFRMO	CH	CMAT	CND	CW	DRWPWR	DRWTK	EXBK	EX	FB	FFD	FPEB	FTK	FTK_V	ID	INVFRM	MIP	RD	RECTK	RT	TKP	TOTSSS	VTK
•	•	•	•	•	•	•	•	• ¹	•	• ²	•	•	•	•	•	•	•	•	•	•	•	•	•	•	•	•	•

Construction Upgrades

APC	PE
•	•

Door Options

ALF	CG	DPSRR	MD	MFO
•	•	•	•	•

¹ Not available on 42" and 45" wide

² Available only on 60" wide

FP = False Panel

VANITY SINK DRAWER BASE with SIX DRAWERS & FALSE PANEL, 34 1/2" HIGH, 21" DEEP

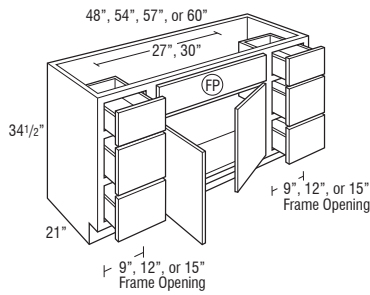
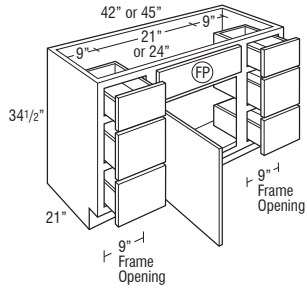

(FP) = False Panel

Price Point

	1	2	3	4	5	6	7	8	9	10	11	12
6VSD423421FP L or R	3073	3104	3125	3146	3167	3189	3343	3468	3584	3685	3771	4064
6VSD453421FP L or R	3157	3189	3211	3233	3256	3277	3438	3565	3685	3790	3879	4181

6VSD483421FP	3241	3274	3297	3320	3343	3366	3534	3661	3784	3894	3986	4297
6VSD543421FP	3408	3442	3468	3492	3518	3543	3723	3856	3987	4106	4202	4528
6VSD573421FP	3378	3491	3527	3562	3596	3631	3817	3951	4087	4211	4310	4644
6VSD603421FP	3574	3610	3638	3665	3692	3718	3912	4047	4188	4316	4417	4760

	Face Frame Opening Width		Available Sink Clearance Width	# of Sink Openings	# of Drawers
	Drawers	Doors			
6VSD42...	9"	15"	21"	1	6
6VSD45...	9"	18"	24"	1	6
6VSD48...	9"	21"	27"	1	6
6VSD54...	12"	21"	27"	1	6
6VSD57...	12"	24"	30"	1	6
6VSD60...	15"	21"	27"	1	6

Custom Modifications

AUTH	CBO	CCO	CFNTO	CFP	CFRMO	CH	CMAT	CND	CW	DRWPWR	DRWTK	EXBK	EX	FB	FFD	FPFB	FTK	FTK_V	ID	INVFRM	MIP	RD	RECTK_	RT	TKP	TOTSSS	VTK
•	•	•	•	•	•	•	•	•	•	•	•	•	•	•	•	•	•	•	•	•	•	•	•	•	•	•	•

Construction Upgrades

APC	PE
•	•

Door Options

ALF	CG	DPSRR	MD	MFO
•	•	•	•	•

¹ Not available on 42" and 45" wide
² Available only on 60" wide

VANITY SINK DRAWER BASE with EIGHT DRAWERS, 34 1/2" HIGH, 21" DEEP

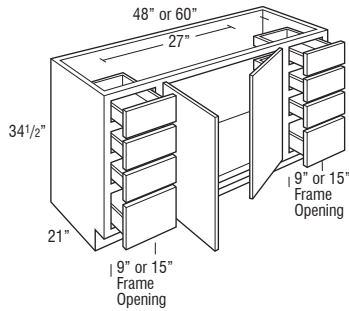

8VSD483421	3307	3324	3375	3424	3474	3524	3672	3786	3896	3985	4062	4336
8VSD603421	3537	3555	3624	3693	3762	3830	4000	4124	4243	4352	4439	4741

	Face Frame Opening Width		Available Sink Clearance Width	# of Sink Openings	# of Drawers
	Drawers	Doors			
8VSD48...	9"	21"	27"	1	8
8VSD60...	15"	21"	27"	1	8

Custom Modifications

AUTH	CBO	CCO	CFNTO	CFP	CFRMO	CH	CMAT	CND	CW	DRWPWR	DRWTK	EXBK	EX	FB	FFD	FPFB	FTK	FTK_V	ID	INVFRM	MIP	RD	RECTK_	RT	TKP	TOTSSS	VTK
•	•	•	•	•	•	•	•	•	•	•	•	•	•	•	•	•	•	•	•	•	•	•	•	•	•	•	•

Construction Upgrades

APC	PE
•	•

Door Options

ALF	CG	DPSRR	MD	MFO
•	•	•	•	•

¹ Available only on 60" wide

VANITY SINK DRAWER BASE with EIGHT DRAWERS & FALSE PANEL, 34 1/2" HIGH, 21" DEEP

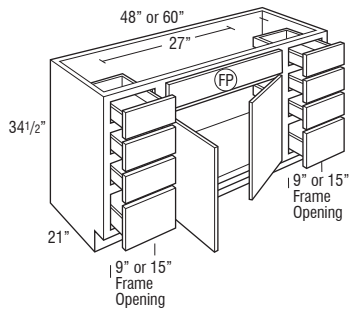

8VSD483421FP	3544	3562	3644	3726	3809	3891	4060	4192	4316	4418	4511	4822
8VSD603421FP	3809	3828	3932	4036	4141	4245	4439	4579	4719	4842	4944	5286

	Face Frame Opening Width		Available Sink Clearance Width	# of Sink Openings	# of Drawers
	Drawers	Doors			
8VSD48...	9"	21"	27"	1	8
8VSD60...	15"	21"	27"	1	8

Custom Modifications

AUTH	CBO	CCO	CFNTO	CFP	CFRMO	CH	CMAT	CND	CW	DRWPWR	DRWTK	EXBK	EX	FB	FFD	FPFB	FTK	FTK_V	ID	INVFRM	MIP	RD	RECTK_	RT	TKP	TOTSSS	VTK
•	•	•	•	•	•	•	•	•	•	•	•	•	•	•	•	•	•	•	•	•	•	•	•	•	•	•	•

Construction Upgrades

APC	PE
•	•

Door Options

ALF	CG	DPSRR	MD	MFO
•	•	•	•	•

¹ Available only on 60" wide

(FP) = False Panel

**UNDER COUNTER DRAWER,
4 3/4" HIGH, 21" DEEP**

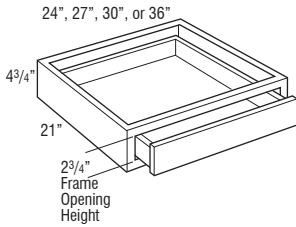

Price Point

	1	2	3	4	5	6	7	8	9	10	11	12
UCD2421	476	478	484	488	493	497	524	547	566	585	601	651
UCD2721	538	540	545	551	557	562	596	623	651	680	721	777
UCDS3021	627	631	636	642	647	653	693	718	745	767	787	852
UCDS3621	718	721	728	735	741	747	793	829	866	905	952	1026

- Cabinet is 4 3/4" high. Drawer box within cabinet is 2" high (outside dimension).
- Not trimmable.
- Drawer front is 3/4" slab front.
- The frame to end panel offset is 3/4", which is designed to accommodate the vanity desk leg.
- Reduced depth is available in 3" increments.

Custom Modifications

AUTH	CBO	CCO	CFNT0	CFP	CFRMO	CH	CMAT	CND	CW	DRWPWR	DRWTK	EXBK	EX	FB	FFD	FPEB	FTK	FTK_V	ID	INVFRM	MIP	RD	RECTK	RT	TKP	TOTSSS	VTK
		•			•									•								•					

Construction Upgrades

APC	PE
•	STD

Door Options

ALF	CG	DPSRR	MD	MFO

**UNDER COUNTER DRAWER
TRIMMABLE, 4 3/4" HIGH, 21" DEEP**

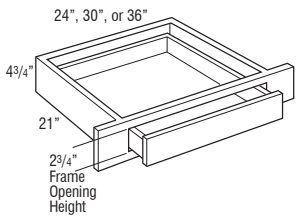

	1	2	3	4	5	6	7	8	9	10	11	12
UCDT2421	476	478	484	488	493	497	524	547	566	585	601	651
UCDT3021	627	631	636	642	647	653	693	718	745	767	787	852
UCDT3621	718	721	728	735	741	747	793	829	866	905	952	1026

- Cabinet is 4 3/4" high. Drawer box within cabinet is 2" high (outside dimension).
- Frame stile is trimmable 3" on each side.
- Drawer front is 3/4" slab front.
- The frame to end panel offset is 3/4", which is designed to accommodate the vanity desk leg.
- Reduced depth is available in 3" increments.

Custom Modifications

AUTH	CBO	CCO	CFNT0	CFP	CFRMO	CH	CMAT	CND	CW	DRWPWR	DRWTK	EXBK	EX	FB	FFD	FPEB	FTK	FTK_V	ID	INVFRM	MIP	RD	RECTK	RT	TKP	TOTSSS	VTK
		•			•																	•		•			

Construction Upgrades

APC	PE
•	STD

Door Options

ALF	CG	DPSRR	MD	MFO

**VANITY HAMPER,
32" HIGH, 21" DEEP**

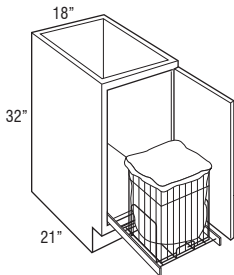

	1	2	3	4	5	6	7	8	9	10	11	12
VH183221FH L or R	841	909	921	931	942	952	1005	1037	1077	1109	1140	1231

- Includes full extension removable chrome pull-out hamper with removable cloth liner.
- Hamper size is 19 3/8" high x 14 3/4" wide x 18" deep.
- Replacement liners sold separately as an accessory for field installation. See page 313.

Custom Modifications

AUTH	CBO	CCO	CFNT0	CFP	CFRMO	CH	CMAT	CND	CW	DRWPWR	DRWTK	EXBK	EX	FB	FFD	FPEB	FTK	FTK_V	ID	INVFRM	MIP	RD	RECTK	RT	TKP	TOTSSS	VTK
		•			•																		•		•		

Construction Upgrades

APC	PE
•	•

Door Options

ALF	CG	DPSRR	MD	MFO
		•		

**VANITY HAMPER with DRAWER,
34 1/2" HIGH, 21" DEEP**

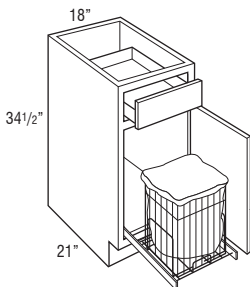

	1	2	3	4	5	6	7	8	9	10	11	12
VBH183421 L or R	636	683	710	737	764	791	834	869	900	933	962	1042

- Includes full extension removable chrome pull-out hamper with removable cloth liner.
- Hamper size is 19 3/8" high x 14 3/4" wide x 18" deep.
- Replacement liners sold separately as an accessory for field installation. See page 313.

Custom Modifications

AUTH	CBO	CCO	CFNT0	CFP	CFRMO	CH	CMAT	CND	CW	DRWPWR	DRWTK	EXBK	EX	FB	FFD	FPEB	FTK	FTK_V	ID	INVFRM	MIP	RD	RECTK	RT	TKP	TOTSSS	VTK
		•			•																		•		•		

Construction Upgrades

APC	PE
•	•

Door Options

ALF	CG	DPSRR	MD	MFO
		•		

LINEN TALL

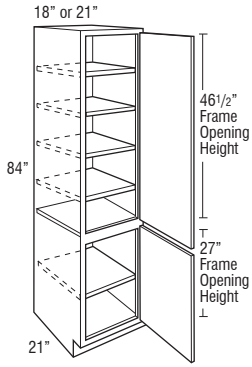

Price Point	1	2	3	4	5	6	7	8	9	10	11	12
LT188421 L or R	1425	1659	1721	1783	1845	1906	2026	2104	2187	2268	2330	2522
LT218421 L or R	1566	1826	1895	1963	2032	2100	2229	2316	2406	2498	2564	2778

- Recommended for use with 34 1/2" high cabinets (bottom door will align with top of drawer front or top of full height door).

Custom Modifications

AUTH	CBO	CCO	CFNTO	CFP	CFRMO	CH	CMAT	CND	CW	DRWPWR	DRWTK	EXBK	EX	FB	FFD	FPEB	FTK	FTK_V	ID	INVFRM	MIP	RD	RECTK	RT	TKP	TOTSSS	VTK

Construction Upgrades

APC	PE

Door Options

ALF	CG	DPSRR	MD	MFO

¹ Minimum height is 70 3/4"

² RECTKALL and RECTKBK not available

LINEN CLOSET with REMOVABLE HAMPER

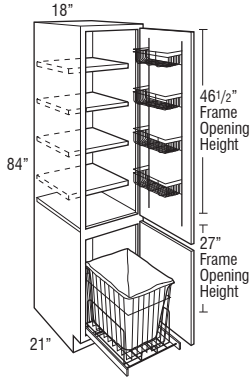

LCRH188421 L or R	2073	2307	2369	2431	2493	2554	2674	2752	2835	2916	2978	3170
-------------------	------	------	------	------	------	------	------	------	------	------	------	------

- Upper section features a 5" deep chrome door rack.
- 15" deep adjustable shelves indicated by light dotted lines are included; packaged separately.
- Includes full extension removable chrome pull-out hamper with removable cloth liner.
- Hamper size is 19 3/8" high x 14 3/4" wide x 18" deep.
- Recommended for use with 34 1/2" high cabinets (bottom door will align with top of drawer front or top of full height door).
- Replacement liners sold separately as an accessory for field installation. See page 313.

Custom Modifications

AUTH	CBO	CCO	CFNTO	CFP	CFRMO	CH	CMAT	CND	CW	DRWPWR	DRWTK	EXBK	EX	FB	FFD	FPEB	FTK	FTK_V	ID	INVFRM	MIP	RD	RECTK	RT	TKP	TOTSSS	VTK

Construction Upgrades

APC	PE

Door Options

ALF	CG	DPSRR	MD	MFO

¹ RECTKALL and RECTKBK not available

LINEN TALL with DRAWER

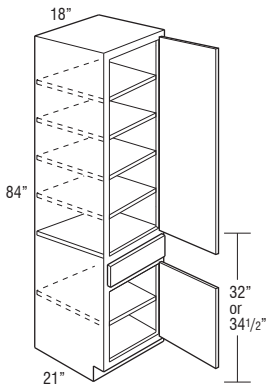

Price Point

	1	2	3	4	5	6	7	8	9	10	11	12
LTD188421 L or R	1618	1845	1921	1997	2073	2149	2265	2344	2430	2504	2570	2766
LTD188421BH L or R	1618	1845	1921	1997	2073	2149	2265	2344	2430	2504	2570	2766

- LTD188421 designed to be used with 32" high vanities.
- LTD188421BH designed to be used with 34 1/2" high vanities.

Custom Modifications

AUTH	CBO	CCO	CFNTO	CFP	CFRMO	CH	CMAT	CND	CW	DRWPPWR	DRWTK	EXBK	EX	FB	FFD	FPEB	FTK	FTK_V	ID	INFRM	MIP	RD	RECTK	RT	TKP	TOTSSS	VTK
•	•	•	•	•	•	• ¹	•	•	•	•	•	•	•	•	•	•	•	•	•	•	•	•	• ²	•	•	•	•

Construction Upgrades

APC	PE
•	•

Door Options

ALF	CG	DPSRR	MD	MFO
•	•	•	•	•

¹ Minimum height on LTD188421 L/R is 68 1/4". Minimum height on LTD188421BH is 70 3/4".
² RECTKALL and RECTKBK not available

LINEN TALL with DRAWER and REMOVABLE HAMPER

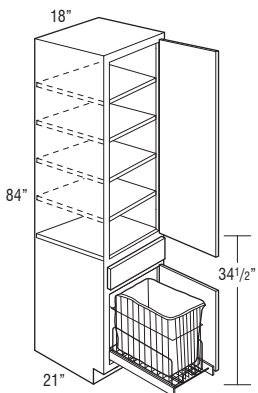

L188421BH L or R	2066	2293	2369	2445	2521	2597	2713	2792	2878	2952	3018	3214
-------------------------	------	------	------	------	------	------	------	------	------	------	------	------

- L188421BH is designed to be used with 34 1/2" high vanities and includes a full extension removable chrome pull-out hamper with removable cloth liner. Hamper size is 19 3/8" high x 14 3/4" wide x 18" deep.

Custom Modifications

AUTH	CBO	CCO	CFNTO	CFP	CFRMO	CH	CMAT	CND	CW	DRWPPWR	DRWTK	EXBK	EX	FB	FFD	FPEB	FTK	FTK_V	ID	INFRM	MIP	RD	RECTK	RT	TKP	TOTSSS	VTK
•	•	•	•	•	•	• ¹	•	•	•	•	•	•	•	•	•	•	•	•	•	•	•	•	• ²	•	•	•	•

Construction Upgrades

APC	PE
•	•

Door Options

ALF	CG	DPSRR	MD	MFO
•	•	•	•	•

¹ Minimum height on L188421BH is 70 3/4".
² RECTKALL and RECTKBK not available

VANITY UTILITY, 84" TALL, 21" DEEP

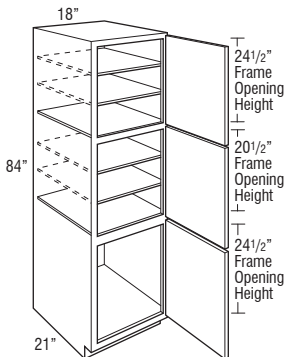

VU188421 L or R	1394	1621	1697	1773	1849	1925	2041	2120	2206	2280	2346	2542
------------------------	------	------	------	------	------	------	------	------	------	------	------	------

- Lower door section is drilled to accept adjustable shelf.
- Vanity utilities designed to be used with 32" high vanities.

Custom Modifications

AUTH	CBO	CCO	CFNTO	CFP	CFRMO	CH	CMAT	CND	CW	DRWPPWR	DRWTK	EXBK	EX	FB	FFD	FPEB	FTK	FTK_V	ID	INFRM	MIP	RD	RECTK	RT	TKP	TOTSSS	VTK
•	•	•	•	•	•	•	•	•	•	•	•	•	•	•	•	•	•	•	•	•	•	•	• ¹	•	•	•	•

Construction Upgrades

APC	PE
•	•

Door Options

ALF	CG	DPSRR	MD	MFO
•	•	•	•	•

¹ RECTKALL and RECTKBK not available

VANITY WALL HUNG TWO DRAWER SINK BASE with FALSE PANEL, 23 1/2" HIGH, 21" DEEP

24", 27", 30", 33", or 36"

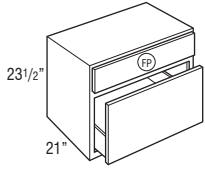

FP = False Panel

Price Point

	1	2	3	4	5	6	7	8	9	10	11	12
VWH2D2423.521FP	1821	1833	1849	1864	1879	1894	1979	2046	2111	2167	2211	2373
VWH2D2723.521FP	1854	1867	1883	1897	1912	1926	2014	2081	2147	2204	2249	2414
VWH2D3023.521FP	1886	1900	1915	1930	1945	1960	2048	2117	2184	2242	2288	2456
VWH2D3323.521FP	1910	1923	1941	1958	1976	1992	2090	2162	2233	2298	2348	2529
VWH2D3623.521FP	1932	1945	1966	1986	2006	2026	2130	2206	2280	2353	2407	2601

- Plumbing clearance of 15 1/16" to the top edge of the lower drawer box (6 3/8" high drawer box).
- 5-piece drawer front configuration will not match on door styles with unique rail widths for drawer fronts over 10" high. Check Door Style section for drawer rail widths by height.
- Features a full cabinet top that can be routed for sink installation.
- Standard with All-plywood Construction (APC) and Furniture Finished Plywood Ends (FPFB).
- Installation to be performed by qualified professionals only.
- Unit must be securely fastened with sufficient type, quantity and size of screws to all available wall studs and internal structural wall blocking placed between wall studs. Additional bracing may be required.
- Installation instructions and required 3 1/2" installation screws included, standard 2 1/2" installation screws are not sufficient in this application.
- The use of internal structural wall blocking (2 x 6's) is required to provide secure horizontal attachment points between wall studs.
- Do not exceed loading of 25 lbs./sq. ft. for countertop and sink.
- Do not exceed loading of 15 lbs./sq. ft. for contents on shelves and/or drawers.
- Avoid use of concrete or other heavy masonry countertops.

Custom Modifications

AUTH	CBO	CCO	CFNTO	CFP	CFRMO	CH	CMAT	CND	CW	DRWPWR	DRWTK	EXBK	EX	FB	FFD	FPFB	FTK	FTK_V	ID	INVFRM	MIP	RD	RECTK	RT	TKP	TOTSSS	VTK
•	•	•			STD	•			• ¹					•		STD							•				

Construction Upgrades

APC	PE
STD	

Door Options

ALF	CG	DPSRR	MD	MFO

¹ Not available on 24" wide

VANITY WALL HUNG TWO DRAWER BASE, 23 1/2" HIGH, 21" DEEP

24", 27", 30", 33", or 36"

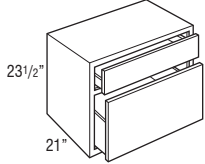

VWH2D2423.521	1917	1931	1945	1960	1975	1989	2074	2141	2206	2261	2305	2467
VWH2D2723.521	1950	1963	1979	1994	2009	2024	2110	2178	2244	2300	2344	2511
VWH2D3023.521	1984	1997	2013	2028	2044	2059	2147	2216	2283	2341	2386	2554
VWH2D3323.521	2007	2022	2040	2056	2074	2091	2187	2260	2332	2396	2446	2626
VWH2D3623.521	2033	2047	2066	2085	2104	2122	2228	2305	2380	2451	2504	2698

- Top drawer box is 3 3/8" high, bottom drawer box is 10" high.
- Cannot be used with a sink due to drawer interference.
- 5-piece drawer front configuration will not match on door styles with unique rail widths for drawer fronts over 10" high. Check Door Style section for drawer rail widths by height.
- Features a full cabinet top.
- Standard with All-plywood Construction (APC) and Furniture Finished Plywood Ends (FPFB).
- Installation to be performed by qualified professionals only.
- Unit must be securely fastened with sufficient type, quantity and size of screws to all available wall studs and internal structural wall blocking placed between wall studs. Additional bracing may be required.
- Installation instructions and required 3 1/2" installation screws included, standard 2 1/2" installation screws are not sufficient in this application.
- The use of internal structural wall blocking (2 x 6's) is required to provide secure horizontal attachment points between wall studs.
- Do not exceed loading of 25 lbs./sq. ft. for countertop and sink.
- Do not exceed loading of 15 lbs./sq. ft. for contents on shelves and/or drawers.
- Avoid use of concrete or other heavy masonry countertops.

Custom Modifications

AUTH	CBO	CCO	CFNTO	CFP	CFRMO	CH	CMAT	CND	CW	DRWPWR	DRWTK	EXBK	EX	FB	FFD	FPFB	FTK	FTK_V	ID	INVFRM	MIP	RD	RECTK	RT	TKP	TOTSSS	VTK
•	•	•			•				• ¹	•					STD								•				

Construction Upgrades

APC	PE
STD	

Door Options

ALF	CG	DPSRR	MD	MFO

¹ Not available on 24" wide

VANITY WALL HUNG DOUBLE DOOR with U-SHAPED PULL-OUTS, 23 1/2" HIGH, 21" DEEP

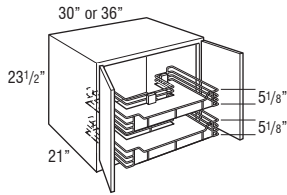

	Price Point	1	2	3	4	5	6	7	8	9	10	11	12
VWH3023.521U		2079	2185	2224	2264	2303	2341	2412	2472	2523	2556	2594	2707
VWH3623.521U		2177	2284	2323	2361	2400	2438	2510	2572	2622	2654	2692	2804

- Includes two chrome U-shaped soft-close pull-outs with non-slip gray shelf liner.
- Bottom pull-out cut-out for U-shape is 6 1/8" from back of cabinet and 15 3/4" wide.
- Top pull-out cut-out for U-shape is 12 1/8" from back of cabinet and 15 3/4" wide.
- VWH3023.521U pull-outs are 25 1/4" wide and 17" deep.
- VWH3623.521U pull-outs are 31 1/4" wide and 17" deep.
- Features a full cabinet top that can be routed for sink installation.
- Standard with All-plywood Construction (APC) and Furniture Finished Plywood Ends (FPFB).
- Installation to be performed by qualified professionals only.
- Unit must be securely fastened with sufficient type, quantity and size of screws to all available wall studs and internal structural wall blocking placed between wall studs. Additional bracing may be required.
- Installation instructions and required 3 1/2" installation screws included, standard 2 1/2" installation screws are not sufficient in this application.
- The use of internal structural wall blocking (2 x 6's) is required to provide secure horizontal attachment points between wall studs.
- Do not exceed loading of 25 lbs./sq. ft. for countertop and sink.
- Do not exceed loading of 15 lbs./sq. ft. for contents on shelves and/or drawers.
- Avoid use of concrete or other heavy masonry countertops.

Custom Modifications

AUTH	CBO	CCO	CFNTO	CFP	CFRMO	CH	CMAT	CND	CW	DRWPWR	DRWTK	EXBK	EX	FB	FFD	FPFB	FTK	FTK_V	ID	INVFRM	MIP	RD	RECTK_	RT	TKP	TOTSSS	VTK
•	•	•	•	•	•	•	•	•	•	•	•	•	•	•	•	•	•	•	•	•	•	•	•	•	•	•	•

Construction Upgrades

APC	PE
•	•
STD	

Door Options

ALF	CG	DPSRR	MD	MFO
•	•	•	•	•
•	•	•	•	•

VANITY WALL HUNG SINGLE DOOR, 23 1/2" HIGH, 21" DEEP

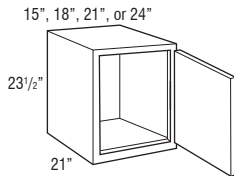

VWH1523.521 L or R	905	967	988	1009	1030	1052	1100	1131	1166	1198	1220	1294
VWH1823.521 L or R	928	991	1014	1036	1058	1080	1129	1160	1195	1229	1251	1326
VWH2123.521 L or R	952	1017	1039	1062	1084	1107	1157	1189	1226	1260	1282	1360
VWH2423.521 L or R	977	1042	1065	1089	1112	1135	1186	1221	1258	1292	1315	1396

- Features a full cabinet top that can be routed for sink installation.
- Standard with All-plywood Construction (APC) and Furniture Finished Plywood Ends (FPFB).
- Installation to be performed by qualified professionals only.
- Unit must be securely fastened with sufficient type, quantity and size of screws to all available wall studs and internal structural wall blocking placed between wall studs. Additional bracing may be required.
- Installation instructions and required 3 1/2" installation screws included, standard 2 1/2" installation screws are not sufficient in this application.
- The use of internal structural wall blocking (2 x 6's) is required to provide secure horizontal attachment points between wall studs.
- Do not exceed loading of 25 lbs./sq. ft. for countertop and sink.
- Do not exceed loading of 15 lbs./sq. ft. for contents on shelves and/or drawers.
- Avoid use of concrete or other heavy masonry countertops.

Custom Modifications

AUTH	CBO	CCO	CFNTO	CFP	CFRMO	CH	CMAT	CND	CW	DRWPWR	DRWTK	EXBK	EX	FB	FFD	FPFB	FTK	FTK_V	ID	INVFRM	MIP	RD	RECTK_	RT	TKP	TOTSSS	VTK
•	•	•	•	•	•	•	•	•	•	•	•	•	•	•	•	•	•	•	•	•	•	•	•	•	•	•	•

Construction Upgrades

APC	PE
•	•
STD	

Door Options

ALF	CG	DPSRR	MD	MFO
•	•	•	•	•
•	•	•	•	•

¹ Not available on 15" wide

VANITY WALL HUNG DOUBLE DOOR, 23 1/2" HIGH, 21" DEEP

24", 27", 30", 33", or 36"

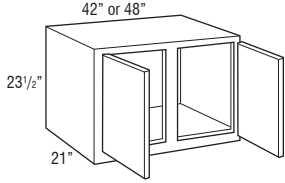
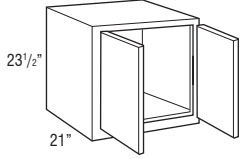

Price Point	1	2	3	4	5	6	7	8	9	10	11	12
VWH2423.521	1001	1068	1093	1117	1141	1165	1217	1251	1290	1325	1348	1430
VWH2723.521	1027	1096	1121	1146	1170	1194	1249	1284	1323	1360	1383	1467
VWH3023.521	1054	1124	1150	1175	1200	1224	1280	1316	1356	1394	1419	1505
VWH3323.521	1086	1169	1198	1226	1256	1284	1341	1382	1424	1463	1490	1585
VWH3623.521	1119	1214	1247	1278	1310	1342	1400	1447	1490	1531	1559	1662

VWH4223.521	1188	1292	1329	1366	1403	1439	1505	1555	1606	1645	1681	1793
VWH4823.521CS	1313	1429	1467	1505	1543	1581	1659	1751	1851	1861	1960	2097

- Features a full cabinet top that can be routed for sink installation.
- Standard with All-plywood Construction (APC) and Furniture Finished Plywood Ends (FPFB).
- Installation to be performed by qualified professionals only.
- Unit must be securely fastened with sufficient type, quantity and size of screws to all available wall studs and internal structural wall blocking placed between wall studs. Additional bracing may be required.
- Installation instructions and required 3 1/2" installation screws included, standard 2 1/2" installation screws are not sufficient in this application.
- The use of internal structural wall blocking (2 x 6's) is required to provide secure horizontal attachment points between wall studs.
- Do not exceed loading of 25 lbs./sq. ft. for countertop and sink.
- Do not exceed loading of 15 lbs./sq. ft. for contents on shelves and/or drawers.
- Avoid use of concrete or other heavy masonry countertops.

Custom Modifications

AUTH	CBO	CCO	CFNTO	CFP	CFRMO	CH	CMAT	CND	CW	DRWPWR	DRWTK	EXBK	EX	FB	FFD	FPFB	FTK	FTK_V	ID	INVFRM	MIP	RD	RECTK	RT	TKP	TOTSSS	VTK
•	•	•	•	•	•				• ¹							STD						•	•		•		

Construction Upgrades

APC	PE
STD	

Door Options

ALF	CG	DPSRR	MD	MFO
		•		

¹ Not available on 24" wide

VANITY WALL CUBBY

27"

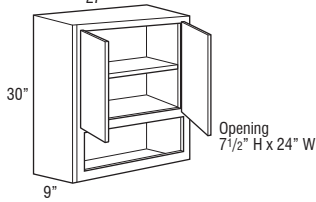

VWC2730	806	912	963	1014	1065	1116	1185	1231	1279	1326	1362	1474
----------------	-----	-----	-----	------	------	------	------	------	------	------	------	------

- Includes 1 adjustable shelf.

Custom Modifications

AUTH	CBO	CCO	CFNTO	CFP	CFRMO	CH	CMAT	CND	CW	DRWPWR	DRWTK	EXBK	EX	FB	FFD	FPFB	FTK	FTK_V	ID	INVFRM	MIP	RD	RECTK	RT	TKP	TOTSSS	VTK
•	•	•	•	•	•				• ¹														STD				

Construction Upgrades

APC	PE

Door Options

ALF	CG	DPSRR	MD	MFO
		•		•

¹ Minimum height is 21". Minimum width is 24".

VANITY WALL, 30" HIGH, 6" DEEP

12", 15", 18", or 24"

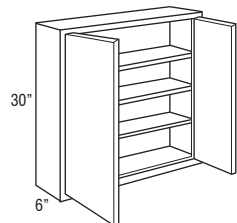
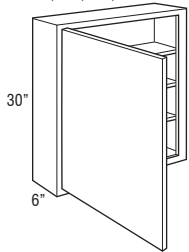

W12306 L or R	404	455	477	500	522	543	576	599	620	645	662	717
W15306 L or R	426	502	523	544	566	586	619	647	671	693	713	773
W18306 L or R	455	533	559	584	608	633	673	697	725	752	772	833
W24306 L or R	605	697	722	747	773	797	846	878	912	941	971	1051

W24306	660	764	790	814	840	865	917	953	991	1027	1054	1142
---------------	-----	-----	-----	-----	-----	-----	-----	-----	-----	------	------	------

- If a different depth is desired, select a wall cabinet with ID or RD modifications available.

Custom Modifications

AUTH	CBO	CCO	CFNTO	CFP	CFRMO	CH	CMAT	CND	CW	DRWPWR	DRWTK	EXBK	EX	FB	FFD	FPFB	FTK	FTK_V	ID	INVFRM	MIP	RD	RECTK	RT	TKP	TOTSSS	VTK
•	•	•	•	•	•				• ¹														•				

Construction Upgrades

APC	PE
•	•

Door Options

ALF	CG	DPSRR	MD	MFO
• ²		•	• ³	•

¹ Not available on 12" and 24" (2 doors) wide

² Not available on 24" wide

³ Not available on 12" wide

**VANITY WALL MIRROR CABINET,
30" HIGH, 4 9/16" DEEP**

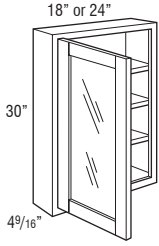

	Price Point	1	2	3	4	5	6	7	8	9	10	11	12
VWM1830 L or R		563	641	662	682	702	722	762	786	816	840	864	926
VWM2430 L or R		675	767	793	818	842	867	915	948	981	1012	1042	1120

- Standard with CG doors and installed mirror glass.
- Unit intended to be surface mounted. Features standard 1/4" face frame reveal on ends.
- Not available on certain door styles. See Door Style section for exceptions.
- Adjustable shelves.

Custom Modifications

AUTH	CBO	CCO	CFNTO	CFP	CFRMO	CH	CMAT	CND	CW	DRWPPWR	DRWTK	EXBK	EX	FB	FFD	FPEB	FTK	FTK_V	ID	INVERM	MIP	RD	RECTK	RT	TKP	TOTSSS	VTK
		•											•	•		•						•					

Construction Upgrades

APC	PE
•	•

Door Options

ALF	CG	DPSRR	MD	MFO
	STD			

VANITY MIRROR

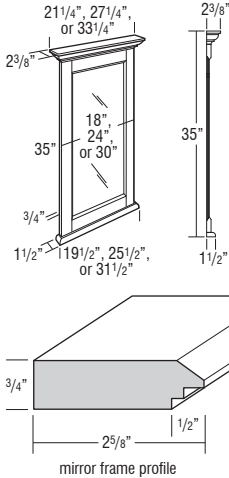

VM2135	N/A	850	850	850	850	850	850	850	850	850	850	850	850
VM2735	N/A	922	922	922	922	922	922	922	922	922	922	922	922
VM3335	N/A	1005	1005	1005	1005	1005	1005	1005	1005	1005	1005	1005	1005

- Moulding included on vanity mirror is not a standard moulding. SWLCRM8 is similar.
- Mirror glass is beveled.
- Includes two installed metal hanging hooks on back.

Model	Overall Dimensions Width	Overall Dimensions Height	Mirror - Visible Dimensions Width	Mirror - Visible Dimensions Height
VM2135	21 1/4"	35"	12 15/16"	26 15/16"
VM2735	27 1/4"	35"	18 15/16"	26 15/16"
VM3335	33 1/4"	35"	24 15/16"	26 15/16"

MODIFICATIONS
No modifications available for these products.

Finish Techniques
Heirlooming
•

Species Availability

Rustic Alder	Cherry	Rustic Hickory	Laminate	Maple	Oak
	•		box color		•

SINGLE DOOR MEDICINE CABINET

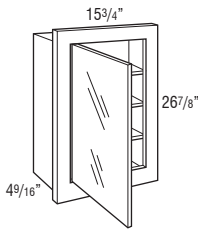

MC16	983	983	983	983	983	983	983	983	983	983	983	983	983
-------------	-----	-----	-----	-----	-----	-----	-----	-----	-----	-----	-----	-----	-----

- Unit can be surface mounted or recessed.
- Door of cabinet is glass mirror, 12 5/8" wide x 23 1/2" high.
- Matching cabinet doors not available.
- Cabinet has wood frame.
- Finished exterior.
- Standard interior.
- If ordered with Heirlooming Technique, will not feature sand-through characteristics.

Model	Cabinet Dimensions Width	Cabinet Dimensions Height	Cabinet Dimensions Depth	Cut-out Dimensions Width	Cut-out Dimensions Height	Cut-out Dimensions Depth
MC16	15 3/4"	26 7/8"	4 9/16"	14 7/16"	25 5/8"	4"

Custom Modifications

AUTH	CBO	CCO	CFNTO	CFP	CFRMO	CH	CMAT	CND	CW	DRWPPWR	DRWTK	EXBK	EX	FB	FFD	FPEB	FTK	FTK_V	ID	INVERM	MIP	RD	RECTK	RT	TKP	TOTSSS	VTK
		•													STD								•				

Construction Upgrades

APC	PE
STD	

Door Options

ALF	CG	DPSRR	MD	MFO

TRI-VIEW MEDICINE CABINET

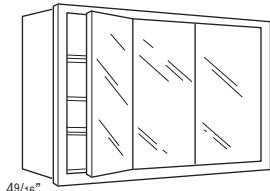

26 7/8"

4 9/16"

Price Point

	1	2	3	4	5	6	7	8	9	10	11	12
TV30	1139	1139	1139	1139	1139	1139	1139	1139	1139	1139	1139	1139
TV36	1238	1238	1238	1238	1238	1238	1238	1238	1238	1238	1238	1238
TV48	1553	1553	1553	1553	1553	1553	1553	1553	1553	1553	1553	1553

- Cabinet has wood frame.
- Door of cabinet is glass mirror.
- Unit can be surface mounted or recessed.
- Finished exterior.
- Standard interior.
- If ordered with Heirloom Technique, will not feature sand-through characteristics.

Model	Width	Cabinet Dimensions		Cut-out Dimensions		
		Height	Depth	Width	Height	Depth
TV30	30"	26 7/8"	4 9/16"	28 11/16"	25 5/8"	4"
TV36	36"	26 7/8"	4 9/16"	34 11/16"	25 5/8"	4"
TV48	48"	26 7/8"	4 9/16"	46 11/16"	25 5/8"	4"

Custom Modifications

AUTH	CBO	CCO	CFNT0	CFP	CFRMO	CH	CMAT	CND	CW	DRWPWR	DRWTK	EXBK	EX	FB	FFD	FPEB	FTK	FTK_V	ID	INVERM	MIP	RD	RECTK	RT	TKP	TOTSSS	VTK
		•													STD							•					

Construction Upgrades

APC	PE
STD	

Door Options

ALF	CG	DPSRR	MD	MFO

TABLE OF CONTENTS – FILLERS & PANELS

Fillers255

Box Column Fillers260

End Panel Skins263

Back Panels264

End Panels265

End Panel with Filler Attached267

V-groove End Panel271

Decorative Door Panel Kits272

Wainscoting273

Appliance Panels274

Custom Hinged Doors277

When designing with full overlay door styles, apply overlay fillers onto fillers.

All 1/4" thick panel material cannot be used in conjunction with cabinets with FPFB or AUTHL/AUTHR/AUTHB modifications

For premium panels, High Gloss availability matches Vertical Grain availability. Horizontal Grain panels cannot be ordered with High Gloss

Premium, horizontal grain, overlay fillers greater than 48" high will be comprised of two segments and require field assembly (allow 3/16" gap between overlays for alignment with adjacent doors).

SPECIES AVAILABILITY

Species Availability charts list the availability of each product code by species and any substitutions that are made. Exceptions within a section are noted below the species availability chart.

For panels with doors and/or fillers attached, species availability is shown for the panel and filler only.

For Species Availability, look for this chart throughout. For trim items ordered with Laminates, trim items matching the cabinet box color are noted in the charts.

MDF door styles will use Maple for trim and panels, refer to Maple in the Species Availability charts.

Species Availability

Rustic Alder	Cherry	Rustic Hickory	Laminate	Maple	Oak
Alder	•	Hickory	box color	•	•

DESCRIPTION

MODEL

PRICE

FILLERS

3" WIDE FILLERS

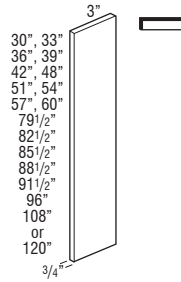

F3



F330	57
F333	64
F336	73
F339	81
F342	88
F348	103
F351	108
F354	111
F357	114
F360	118
TF384	125
TF387	140
TF390	155
TF393	185
TF396	185
TF396FH	232
TF3108FH† ♦	301
TF3120FH† ♦♦	311

- 3/4" thick.
- Finished on front and all edges (backs are not finished).
- †5 day Express Response not available.

Finish Techniques

Heirlooming

Species Availability

Rustic Alder	Cherry	Rustic Hickory	Laminate	Maple	Oak
Alder	•	Hickory	box color	•	•

- ♦ Only available in Maple.
- ♦♦ Only available in Cherry and Maple.

3" WIDE FILLER RETURN



F3R



F3R	37
------------	----

- Creates a toekick appearance when used with 3" wide fillers.
- 3/8" thick, Natural Maple laminated furniture board.

3" WIDE CORNER FILLER

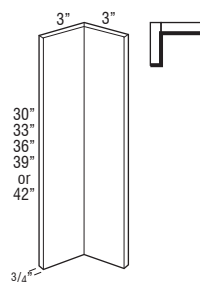

CF3



CF330	105
CF333	119
CF336	132
CF339	146
CF342	158

- 3/4" thick.
- Finished on front and all edges (backs are not finished).

Finish Techniques

Heirlooming

Species Availability

Rustic Alder	Cherry	Rustic Hickory	Laminate	Maple	Oak
Alder	•	Hickory	box color	•	•

Finished edges indicated by bold lines on side view drawings.
Glazed edges indicated by arrows on side view drawings.

DESCRIPTION MODEL PRICE

6" WIDE FILLERS

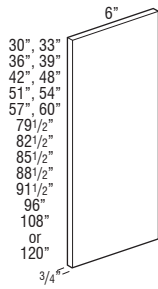

F6



F630	92
F633	102
F636	113
F639	124
F642	132
F648	194
F651	197
F654	204
F657	207
F660	211
TF684	218
TF687	245
TF690	270
TF693	316
TF696	316
TF696FH	396
TF6108FH† ♦	515
TF6120FH† ♦ ♦	535

- 3/4" thick.
 - Finished on front and all edges (backs are not finished).
- 15 day Express Response not available.

Finish Techniques

Heirlooming

Species Availability

Rustic Alder	Cherry	Rustic Hickory	Laminate	Maple	Oak
Alder	•	Hickory	box color	•	•

- ♦ Only available in Maple.
- ♦ ♦ Only available in Cherry and Maple.

6" WIDE FILLER RETURN

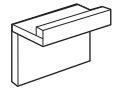

F6R



F6R	43
------------	----

- Creates a toekick appearance when used with 6" wide fillers.
- 3/8" thick, Natural Maple laminated furniture board.

SPACE FILLERS

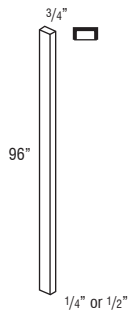

S96X14 (1/4" thick)	53
S96X12 (1/2" thick)	69

- S96 is 1/4" or 1/2" thick.
- Designed to fill space between adjacent cabinets; i.e. W1830 butted against side of U188424.
- Finished on front and all edges (backs are not finished).

Finish Techniques

Heirlooming

Species Availability

Rustic Alder	Cherry	Rustic Hickory	Laminate	Maple	Oak
Alder	•	Hickory	box color	•	•

DESCRIPTION MODEL PRICE

OVERLAY FILLER, 2 1/2" WIDE

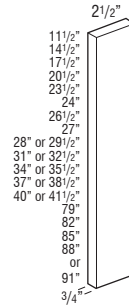

OL312 (11 1/2"H)	55
OL315 (14 1/2"H)	56
OL318 (17 1/2"H)	57
OL321 (20 1/2"H)	60
OL324 (23 1/2"H)	62
OL327 (26 1/2"H)	63
OL330 (28"H or 29 1/2"H)	74
OL333 (31"H or 32 1/2"H)	81
OL336 (34"H or 35 1/2"H)	86
OL339 (37"H or 38 1/2"H)	93
OL342 (40"H or 41 1/2"H)	93
OL384 (79"H)	155
OL387 (82"H)	164
OL390 (85"H)	171
OL393 (88"H)	192
OL396 (91"H)	192
VOL332 (27"H)	63
DOL329 (24"H)	63

- All overlay fillers available in full overlay door styles.
- OL330, OL333, OL336, OL339, OL342 also available in partial overlay door styles. Overlays for partial overlay door styles will match partial overlay door height.
- 2 1/2" wide overlay fillers can be applied to Wall Message Centers to create custom finished look.
- Overlays match door profile and thickness.
- Finished on front and all edges (backs are not finished).
- See OL__MFO on page 257 for use with Modified Full Overlay modification.

Finish Techniques

Heirlooming

Species Availability

Rustic Alder	Cherry	Rustic Hickory	Laminate	Maple	Oak
Alder	•	Hickory		•	•

Finished edges indicated by bold lines on side view drawings.
Glazed edges indicated by arrows on side view drawings.

DESCRIPTION	MODEL	PRICE
-------------	-------	-------

**OVERLAY FILLER
for MODIFIED FULL
OVERLAY, 2 1/2" WIDE**

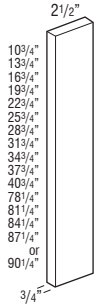

OL312MFO (10 3/4"H)	55
OL315MFO (13 3/4"H)	56
OL318MFO (16 3/4"H)	57
OL321MFO (19 3/4"H)	60
OL324MFO (22 3/4"H)	62
OL327MFO (25 3/4"H)	63
OL330MFO (28 3/4"H)	74
OL333MFO (31 3/4"H)	81
OL336MFO (34 3/4"H)	86
OL339MFO (37 3/4"H)	93
OL342MFO (40 3/4"H)	93
OL384MFO (78 1/4"H)	155
OL387MFO (81 1/4"H)	164
OL390MFO (84 1/4"H)	171
OL393MFO (87 1/4"H)	192
OL396MFO (90 1/4"H)	192

- Available in most full overlay door styles. See Door Style section for exceptions. Height will align with wall and tall doors specified with Modified Full Overlay modification. See page 6 for MFO details.
- 2 1/2" wide overlay fillers can be applied to Wall Message Centers to create a custom finished look.
- Overlays match door profile and thickness.
- Finished on front and all edges (backs are not finished).

Finish Techniques

Heirlooming
•

Species Availability

Rustic Alder	Cherry	Rustic Hickory	Laminate	Maple	Oak
	•	Hickory		•	•

DESCRIPTION	MODEL	PRICE
-------------	-------	-------

**OVERLAY FILLER,
PREMIUM, 2 1/2" WIDE**

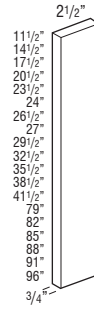

OL312P (11 1/2"H)	111
OL315P (14 1/2"H)	113
OL318P (17 1/2"H)	114
OL321P (20 1/2"H)	121
OL324P (23 1/2"H)	123
OL327P (26 1/2"H)	128
OL330P (29 1/2"H)	148
OL333P (32 1/2"H)	161
OL336P (35 1/2"H)	171
OL339P (38 1/2"H)	185
OL342P (41 1/2"H)	185
OL384P (79"H)	308
OL387P (82"H)	325
OL390P (85"H)	344
OL393P (88"H)	383
OL396P (91"H)	383
OL396FHP (96"H)	402
VOL332P (27"H)	128
DOL329P (24"H)	128

- Overlays match door profile and thickness.
- Front, edges, and backs match door and drawer front construction.
- 2 1/2" wide Overlay Fillers can be applied to Wall Message Center cabinet to create a custom finished look.

Finish Techniques

Heirlooming

Species Availability

Rustic Alder	Cherry	Rustic Hickory	Laminate	Maple	Oak
			•		

DESCRIPTION MODEL PRICE

OVERLAY FILLER for MODIFIED FULL OVERLAY, PREMIUM, 2 1/2" WIDE

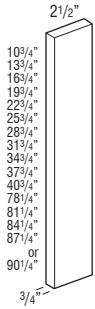

OL312MFOP (10 3/4"H)	111
OL315MFOP (13 3/4"H)	113
OL318MFOP (16 3/4"H)	114
OL321MFOP (19 3/4"H)	121
OL324MFOP (22 3/4"H)	123
OL327MFOP (25 3/4"H)	128
OL330MFOP (28 3/4"H)	148
OL333MFOP (31 3/4"H)	161
OL336MFOP (34 3/4"H)	171
OL339MFOP (37 3/4"H)	185
OL342MFOP (40 3/4"H)	185
OL384MFOP (78 1/4"H)	308
OL387MFOP (81 1/4"H)	325
OL390MFOP (84 1/4"H)	344
OL393MFOP (87 1/4"H)	383
OL396MFOP (90 1/4"H)	383

- Overlays match door profile and thickness.
- Front, edges, and backs match door and drawer front construction.
- Height will align with wall and tall doors specified with Modified Full Overlay modification. See page 6 for MFO details.
- 2 1/2" wide Overlay Fillers can be applied to Wall Message Center cabinet to create a custom finished look.

Finish Techniques

Heirlooming

Species Availability

Rustic Alder	Cherry	Rustic Hickory	Laminate	Maple	Oak
			•		

DESCRIPTION MODEL PRICE

OVERLAY FILLER, 5 1/2" WIDE

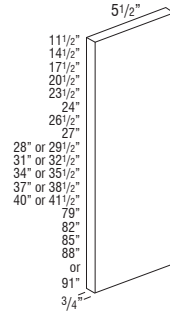

OL612 (11 1/2"H)	93
OL615 (14 1/2"H)	96
OL618 (17 1/2"H)	96
OL621 (20 1/2"H)	97
OL624 (23 1/2"H)	99
OL627 (26 1/2"H)	103
OL630 (28"H or 29 1/2"H)	104
OL633 (31"H or 32 1/2"H)	122
OL636 (34"H or 35 1/2"H)	139
OL639 (37"H or 38 1/2"H)	152
OL642 (40"H or 41 1/2"H)	155
OL684 (79"H)	256
OL687 (82"H)	277
OL690 (85"H)	300
OL693 (88"H)	316
OL696 (91"H)	316
VOL632 (27"H)	103
DOL629 (24"H)	104

- All overlay fillers available in full overlay door styles.
- OL630, OL633, OL636, OL639, OL642 also available in partial overlay door styles. Overlays for partial overlay door styles will match partial overlay door height.
- Overlays match door profile and thickness.
- Finished on front and all edges (backs are not finished).
- See OL__MFO on page 259 for use with Modified Full Overlay modification.

Finish Techniques

Heirlooming
•

Species Availability

Rustic Alder	Cherry	Rustic Hickory	Laminate	Maple	Oak
	•	Hickory		•	•

DESCRIPTION

MODEL

PRICE

**OVERLAY FILLER
for MODIFIED FULL
OVERLAY, 5 1/2" WIDE**

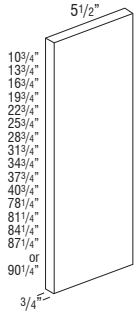

OL612MFO (10 3/4"H)	93
OL615MFO (13 3/4"H)	96
OL618MFO (16 3/4"H)	96
OL621MFO (19 3/4"H)	97
OL624MFO (22 3/4"H)	99
OL627MFO (25 3/4"H)	103
OL630MFO (28 3/4"H)	104
OL633MFO (31 3/4"H)	122
OL636MFO (34 3/4"H)	139
OL639MFO (37 3/4"H)	152
OL642MFO (40 3/4"H)	155
OL684MFO (78 1/4"H)	256
OL687MFO (81 1/4"H)	277
OL690MFO (84 1/4"H)	300
OL693MFO (87 1/4"H)	316
OL696MFO (90 1/4"H)	316

- Available in most full overlay door styles. See Door Style section for exceptions. Height will align with wall and tall doors specified with Modified Full Overlay modification. See page 6 for MFO details.
- Overlays match door profile and thickness.
- Finished on front and all edges (backs are not finished).

Finish Techniques

Heirlooming
•

Species Availability

Rustic Alder	Cherry	Rustic Hickory	Laminate	Maple	Oak
Alder	•	Hickory		•	•

DESCRIPTION

MODEL

PRICE

**OVERLAY FILLER,
PREMIUM, 5 1/2" WIDE**

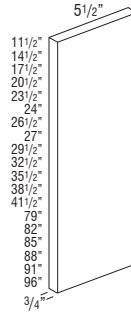

OL612P (11 1/2"H)	185
OL615P (14 1/2"H)	192
OL618P (17 1/2"H)	194
OL621P (20 1/2"H)	196
OL624P (23 1/2"H)	199
OL627P (26 1/2"H)	207
OL630P (29 1/2"H)	209
OL633P (32 1/2"H)	245
OL636P (35 1/2"H)	277
OL639P (38 1/2"H)	307
OL642P (41 1/2"H)	308
OL684P (79"H)	514
OL687P (82"H)	556
OL690P (85"H)	600
OL693P (88"H)	632
OL696P (91"H)	632
OL696FHP (96"H)	664
VOL632P (27"H)	207
DOL629P (24"H)	209

- Overlays match door profile and thickness.
- Front, edges, and backs match door and drawer front construction.

Finish Techniques

Heirlooming

Species Availability

Rustic Alder	Cherry	Rustic Hickory	Laminate	Maple	Oak
		•			

DESCRIPTION MODEL PRICE

OVERLAY FILLER for MODIFIED FULL OVERLAY, PREMIUM, 5 1/2" WIDE

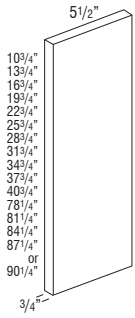

OL612MFOP (10 3/4"H)	185
OL615MFOP (13 3/4"H)	192
OL618MFOP (16 3/4"H)	194
OL621MFOP (19 3/4"H)	196
OL624MFOP (22 3/4"H)	199
OL627MFOP (25 3/4"H)	207
OL630MFOP (28 3/4"H)	209
OL633MFOP (31 3/4"H)	245
OL636MFOP (34 3/4"H)	277
OL639MFOP (37 3/4"H)	307
OL642MFOP (40 3/4"H)	308
OL684MFOP (78 1/4"H)	514
OL687MFOP (81 1/4"H)	556
OL690MFOP (84 1/4"H)	600
OL693MFOP (87 1/4"H)	632
OL696MFOP (90 1/4"H)	632

- Overlays match door profile and thickness.
- Front, edges, and backs match door and drawer front construction.
- Height will align with wall and tall doors specified with Modified Full Overlay modification. See page 6 for MFO details.

Finish Techniques

Heirlooming

Species Availability

Rustic Alder	Cherry	Rustic Hickory	Laminate	Maple	Oak
			•		

DESCRIPTION MODEL PRICE

ANGLED FLUTED/PLAIN 3" WIDE REVERSIBLE FILLERS



BLVDFF30 (3" x 30")	197
BLVDFF34.5 (3" x 34 1/2")	290

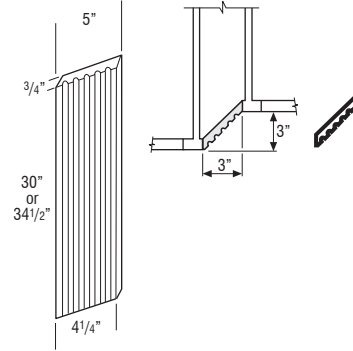

Finish Techniques

Heirlooming

Species Availability

Rustic Alder	Cherry	Rustic Hickory	Laminate	Maple	Oak
	•	Hickory	box color	•	•

BOX COLUMN FILLERS, 1 1/2" WIDE Wall - Plain Column 15" Deep

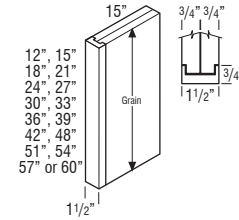

W1.512BCFP	363
W1.515BCFP	380
W1.518BCFP	402
W1.521BCFP	423
W1.524BCFP	446
W1.527BCFP	468
W1.530BCFP	492
W1.533BCFP	512
W1.536BCFP	531
W1.539BCFP	570
W1.542BCFP	570
W1.548BCFP	646
W1.551BCFP	684
W1.554BCFP	722
W1.557BCFP	795
W1.560BCFP	797

- Available in 1" depth increments from 6" to 27".
- Reversible, may be used on either left or right end.
- Front and both sides finished. Top, bottom, and back are unfinished.
- Plywood construction.
- Finished veneer on end panel exterior.
- Not intended for use horizontally as shelving. Use Floating Shelves on page 305.

Custom Modifications

ID	RD
•	•

Finish Techniques

Heirlooming

Species Availability

Rustic Alder	Cherry	Rustic Hickory	Laminate	Maple	Oak
	•	Hickory	box color	•	•

Finished edges indicated by bold lines on side view drawings.
Glazed edges indicated by arrows on side view drawings.

DESCRIPTION

MODEL

PRICE

**BOX COLUMN FILLERS, 3" WIDE
Wall - Plain Column
15" Deep**

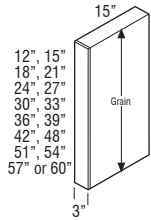

W312BCFP	363
W315BCFP	380
W318BCFP	402
W321BCFP	423
W324BCFP	446
W327BCFP	468
W330BCFP	492
W333BCFP	512
W336BCFP	531
W339BCFP	570
W342BCFP	570
W348BCFP	646
W351BCFP	684
W354BCFP	722
W357BCFP	795
W360BCFP	797

- Available in 1" depth increments from 6" to 27".
- Reversible, may be used on either left or right end.
- Front and both sides finished.
- Enclosed top and bottom (not finished).
- 1/2" plywood construction.
- Finished veneer on end panel exterior.
- No reveal on filler.
- Not intended for use horizontally as shelving. Use Floating Shelves on page 305.

Custom Modifications		Finish Techniques	
ID	RD	Heirlooming	
•	•		

Species Availability					
Rustic Alder	Cherry	Rustic Hickory	Laminate	Maple	Oak
•		Hickory	box color	•	•

**BOX COLUMN FILLERS,
1 1/2" WIDE
Base - Plain Column
27" Deep**

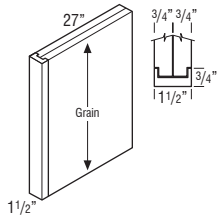

B1.534.527BCFP 897

- Available in 1" depth increments from 6" to 27".
- Reversible, may be used on either left or right end.
- Front and both sides finished. Top, bottom, and back are unfinished.
- Plywood construction.
- Finished veneer on end panel exterior.
- Not intended for use horizontally as shelving. Use Floating Shelves on page 305.

Custom Modifications		Finish Techniques	
ID	RD	Heirlooming	
•	•		

Species Availability					
Rustic Alder	Cherry	Rustic Hickory	Laminate	Maple	Oak
•		Hickory	box color	•	•

DESCRIPTION

MODEL

PRICE

**BOX COLUMN FILLERS, 3" WIDE
Base - Plain Column
27" Deep**

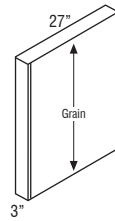

B334.527BCFP 897

- Available in 1" depth increments from 6" to 27".
- Reversible, may be used on either left or right end.
- Front and both sides finished.
- Enclosed top and bottom (not finished).
- 1/2" plywood construction.
- Finished veneer on end panel exterior.
- No reveal on filler.
- Not intended for use horizontally as shelving. Use Floating Shelves on page 305.

Custom Modifications		Finish Techniques	
ID	RD	Heirlooming	
•	•		

Species Availability					
Rustic Alder	Cherry	Rustic Hickory	Laminate	Maple	Oak
•		Hickory	box color	•	•

**BOX COLUMN FILLERS,
1 1/2" WIDE
Tall - Plain Column
15" & 27" Deep**

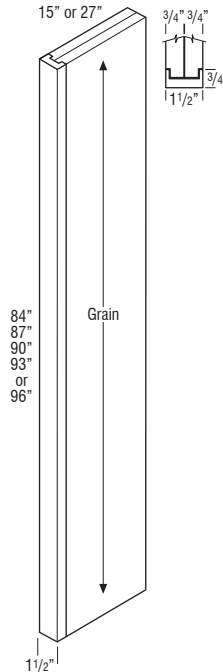

T1.58415BCFP (15" Deep)	1154
T1.58715BCFP (15" Deep)	1161
T1.59015BCFP (15" Deep)	1170
T1.59315BCFP (15" Deep)	1193
T1.59615BCFP (15" Deep)	1193
T1.58427BCFP (27" Deep)	1771
T1.58727BCFP (27" Deep)	1783
T1.59027BCFP (27" Deep)	1799
T1.59327BCFP (27" Deep)	1817
T1.59627BCFP (27" Deep)	1817

- Available in 1" depth increments from 6" to 27".
- Reversible, may be used on either left or right end.
- Front and both sides finished. Top, bottom, and back are unfinished.
- Plywood construction.
- Finished veneer on end panel exterior.
- Not intended for use horizontally as shelving. Use Floating Shelves on page 305.

Custom Modifications		Finish Techniques	
ID	RD	Heirlooming	
• ¹	•		

¹ID only available on 15" deep.

Species Availability					
Rustic Alder	Cherry	Rustic Hickory	Laminate	Maple	Oak
•		Hickory	box color	•	•

DESCRIPTION MODEL PRICE

**BOX COLUMN FILLERS, 3" WIDE
Tall - Plain Column
15" & 27" Deep**

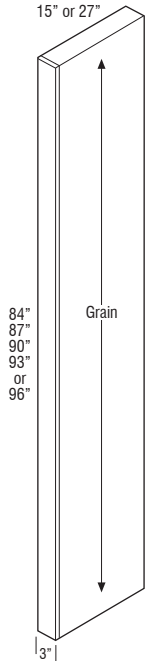

T38415BCFP (15" Deep)	1154
T38715BCFP (15" Deep)	1161
T39015BCFP (15" Deep)	1170
T39315BCFP (15" Deep)	1193
T39615BCFP (15" Deep)	1193
T38427BCFP (27" Deep)	1771
T38727BCFP (27" Deep)	1783
T39027BCFP (27" Deep)	1799
T39327BCFP (27" Deep)	1817
T39627BCFP (27" Deep)	1817

- Available in 1" depth increments from 6" to 27".
- Reversible, may be used on either left or right end.
- Front and both sides finished.
- Enclosed top and bottom (not finished).
- 1/2" plywood construction.
- Finished veneer on end panel exterior.
- No reveal on filler.
- Not intended for use horizontally as shelving. Use Floating Shelves on page 305.

Custom Modifications		Finish Techniques	
ID	RD	Heirlooming	
• ¹	•		

¹ID only available on 15" deep.

Species Availability					
Rustic Alder	Cherry	Rustic Hickory	Laminate	Maple	Oak
•	•	Hickory	box color	•	•

**BOX COLUMN FILLERS, 6" WIDE
Wall - Plain Column
15" Deep**

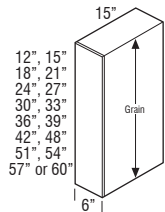

W612BCFP	402
W615BCFP	424
W618BCFP	448
W621BCFP	469
W624BCFP	493
W627BCFP	519
W630BCFP	545
W633BCFP	568
W636BCFP	589
W639BCFP	633
W642BCFP	633
W648BCFP	716
W651BCFP	759
W654BCFP	802
W657BCFP	880
W660BCFP	884

- Available in 1" depth increments from 6" to 27".
- Reversible, may be used on either left or right end.
- Front and both sides finished.
- Enclosed top and bottom (not finished).
- 1/2" plywood construction.
- Finished veneer on end panel exterior.
- No reveal on filler.
- Not intended for use horizontally as shelving. Use Floating Shelves on page 305.

Custom Modifications		Finish Techniques	
ID	RD	Heirlooming	
•	•		

Species Availability					
Rustic Alder	Cherry	Rustic Hickory	Laminate	Maple	Oak
•	•	Hickory	box color	•	•

DESCRIPTION MODEL PRICE

**BOX COLUMN FILLERS, 6" WIDE
Base - Plain Column
27" Deep**

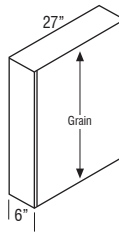

B634.527BCFP	992
---------------------	-----

- Available in 1" depth increments from 6" to 27".
- Reversible, may be used on either left or right end.
- Front and both sides finished.
- Enclosed top and bottom (not finished).
- 1/2" plywood construction.
- Finished veneer on end panel exterior.
- No reveal on filler.
- Not intended for use horizontally as shelving. Use Floating Shelves on page 305.

Custom Modifications		Finish Techniques	
ID	RD	Heirlooming	
•	•		

Species Availability					
Rustic Alder	Cherry	Rustic Hickory	Laminate	Maple	Oak
•	•	Hickory	box color	•	•

**BOX COLUMN FILLERS, 6" WIDE
Tall - Plain Column
15" & 27" Deep**

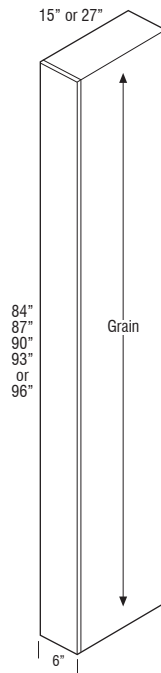

T68415BCFP (15" Deep)	1281
T68715BCFP (15" Deep)	1289
T69015BCFP (15" Deep)	1296
T69315BCFP (15" Deep)	1323
T69615BCFP (15" Deep)	1323
T68427BCFP (27" Deep)	1963
T68727BCFP (27" Deep)	1982
T69027BCFP (27" Deep)	1996
T69327BCFP (27" Deep)	2015
T69627BCFP (27" Deep)	2015

- Available in 1" depth increments from 6" to 27".
- Reversible, may be used on either left or right end.
- Front and both sides finished.
- Enclosed top and bottom (not finished).
- 1/2" plywood construction.
- Finished veneer on end panel exterior.
- No reveal on filler.
- Not intended for use horizontally as shelving. Use Floating Shelves on page 305.

Custom Modifications		Finish Techniques	
ID	RD	Heirlooming	
• ¹	•		

¹ID only available on 15" deep.

Species Availability					
Rustic Alder	Cherry	Rustic Hickory	Laminate	Maple	Oak
•	•	Hickory	box color	•	•

DESCRIPTION
PANELS & SKINS

MODEL

PRICE

END PANEL SKINS, BASE

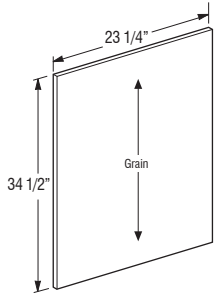

1/4" Finished

BEPS34.5WD 149

- Stains: 1/4" thick veneered furniture board.
- Paints: 1/4" thick veneered or solid furniture board.
- 1/4" (WD) skins recommended for use with PFINBTMB modification.

Custom Modifications

ID	RD
•	•

Finish Techniques

Heirlooming

Species Availability

Rustic Alder	Cherry	Rustic Hickory	Laminate	Maple	Oak
	•	Hickory	box color	•	•

END PANEL SKINS, PREMIUM - BASE

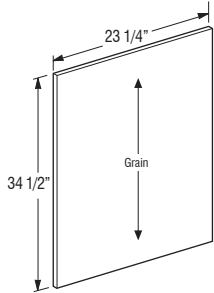

BEPS34.5P 298

- For use with Vertical Grain doors.
- 1/4" thick laminated MDF.
- Not compatible with FPEB.
- 1/4" skins recommended for use with PFINBTMB modification.

Custom Modifications

ID	RD
•	•

Finish Techniques

Heirlooming

Species Availability

Rustic Alder	Cherry	Rustic Hickory	Laminate	Maple	Oak
			•		

END PANEL SKINS, TALL

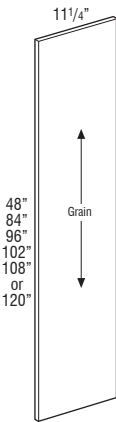

1/4" Finished

TEPS1248WD 190

TEPS1284WD† 276

TEPS1296WD† 276

TEPS12102WD† ♦ 416

TEPS12108WD† ♦ 416

TEPS12120WD† ♦♦ 430

1/4" Finished

TEPS84WD† 325

TEPS87WD† 367

TEPS90WD† 408

TEPS93WD† 487

TEPS96WD† 487

TEPS102WD† ♦ 730

TEPS108WD† ♦ 730

TEPS120WD† ♦♦ 730

- Stains: 1/4" thick veneered furniture board.
- Paints: 1/4" thick veneered or solid furniture board.
- 102", 108", and 120" are 1/4" thick veneered plywood.
- 1/4" (WD) skins recommended for use with PFINBTMB modification.

[†]5 day Express Response not available on items greater than 48".

Custom Modifications

ID	RD
•	•

Finish Techniques

Heirlooming

Species Availability

Rustic Alder	Cherry	Rustic Hickory	Laminate	Maple	Oak
	•	Hickory	box color	•	•

♦ Only available in Maple.

♦♦ Only available in Cherry and Maple.

48"
84"
96"
102"
108"
or
120"

84"
87"
90"
93"
96"
102"
108"
or
120"

DESCRIPTION

MODEL

PRICE

END PANEL SKINS, PREMIUM - TALL

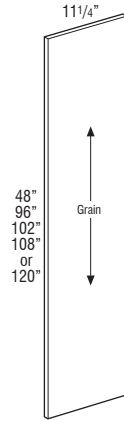

48"
96"
102"
108"
or
120"

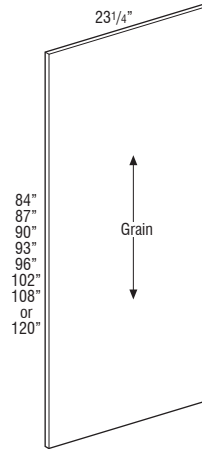

84"
87"
90"
93"
96"
102"
108"
or
120"

TEPS1248P 381

TEPS1296P† 553

TEPS12102P† 830

TEPS12108P† 830

TEPS12120P† 830

TEPS84P† 653

TEPS87P† 736

TEPS90P† 816

TEPS93P† 974

TEPS96P† 974

TEPS102P† 1462

TEPS108P† 1462

TEPS120P† 1462

- For use with Vertical Grain doors.
- 1/4" thick laminated MDF.
- Not compatible with FPEB.
- 1/4" skins recommended for use with PFINBTMB modification.

[†]5 day Express Response not available on items greater than 48".

Custom Modifications

ID	RD
•	•

Finish Techniques

Heirlooming

Species Availability

Rustic Alder	Cherry	Rustic Hickory	Laminate	Maple	Oak
			•		

[†]TEPS12102P, TEPS12108P, TEPS12120P, TEPS102P, TEPS108P, and TEPS120P not available in certain laminate finishes. See Finish Availability section for exception notes.

END PANEL SKINS, WALL



1/4" Finished

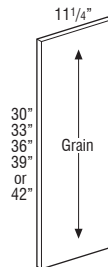

30"
33"
36"
39"
or
42"

WEPS30WD 92

WEPS33WD 102

WEPS36WD 113

WEPS39WD 124

WEPS42WD 132

- Stains: 1/4" thick veneered furniture board.
- Paints: 1/4" thick veneered or solid furniture board.
- 1/4" (WD) skins recommended for use with PFINBTMB modification.

Custom Modifications

ID	RD
•	•

Finish Techniques

Heirlooming

Species Availability

Rustic Alder	Cherry	Rustic Hickory	Laminate	Maple	Oak
	•	Hickory	box color	•	•

DESCRIPTION MODEL PRICE

END PANEL SKINS, PREMIUM - WALL



WEPS30P	184
WEPS33P	205
WEPS36P	224
WEPS39P	250
WEPS42P	264

- For use with Vertical Grain doors.
- 1/4" thick laminated MDF.
- Not compatible with FPEB.
- 1/4" skins recommended for use with PFINBTMB modification.

Custom Modifications		Finish Techniques	
ID	RD	Heirlooming	
•	•		

Species Availability					
Rustic Alder	Cherry	Rustic Hickory	Laminate	Maple	Oak
	•		•		

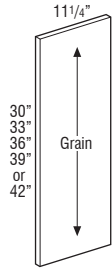

FINISHED BACK SKINS



1/4" Finished	
BP4830WD	225
BP4834.5WD	262
BP4840.5WD	464

1/4" Finished	
BP4896WD†	550

- Stains: 1/4" thick veneered furniture board.
 - Paints: 1/4" thick veneered or solid furniture board.
 - For custom sizes refer to DAPNL 1/4.
- †5 day Express Response not available on items greater than 48".

Custom Modifications		Finish Techniques	
ID	RD	Heirlooming	

Species Availability					
Rustic Alder	Cherry	Rustic Hickory	Laminate	Maple	Oak
Alder	•	Hickory	box color	•	•

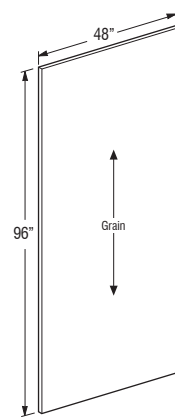
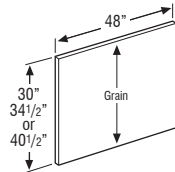

BACK SKIN, INTERIOR

1/4" Natural Maple Laminate	
BP4896LAM	246

- BP4896LAM is 1/4" thick furniture board with Natural Maple laminate to match standard cabinet interior.

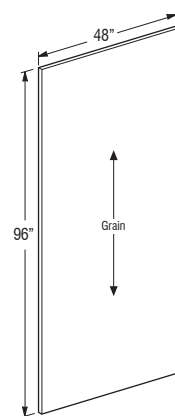

DESCRIPTION MODEL PRICE

FINISHED BACK SKINS, PREMIUM



BP4830P	451
BP4834.5P	524
BP4840.5P	926

BP4896P†	1099
----------	------

- For use with Vertical Grain doors.
 - 1/4" thick laminated MDF.
- †5 day Express Response not available on items greater than 48".

Custom Modifications		Finish Techniques	
ID	RD	Heirlooming	

Species Availability					
Rustic Alder	Cherry	Rustic Hickory	Laminate	Maple	Oak
			•		

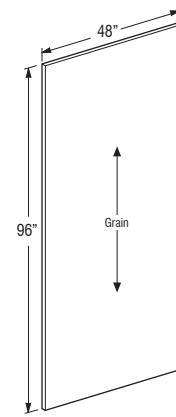
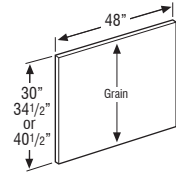

CROSS GRAIN VENEER BACK SKIN 1/4" PANELS

BP9634.5CRSGR	715
BP9640.5CRSGR	715
BP9648CRSGR	715

- Stains: 1/4" thick veneered furniture board.
- When ordered in Paint finishes, panels will use vertical grain models i.e. BP_ _ _ _WD, as grain will not be visible.

Custom Modifications		Finish Techniques	
ID	RD	Heirlooming	

Species Availability					
Rustic Alder	Cherry	Rustic Hickory	Laminate	Maple	Oak
Alder	•	Hickory	box color	•	•

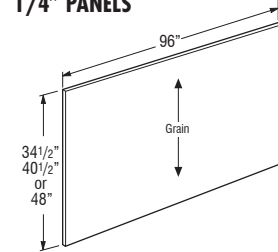

DESCRIPTION

**WOOD V-GROOVED
BEADED SKIN
1/4" PANELS**

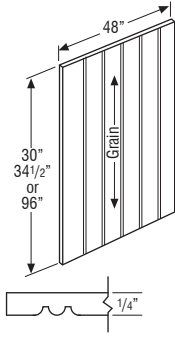

MODEL

BP4830VG	559
BP4834.5VG	601
BP4896VG†	1360

- BP48__VG is a 1/4" thick veneered panel with an MDF core.
- V-groove on 3" centers.
- 15 day Express Response not available on items greater than 48".

Custom Modifications

ID	RD

Finish Techniques

Heirlooming
•

Species Availability

Rustic Alder	Cherry	Rustic Hickory	Laminate	Maple	Oak
	•	Hickory	box color	•	•

**HORIZONTAL GRAIN
1/4" SKIN, PREMIUM**

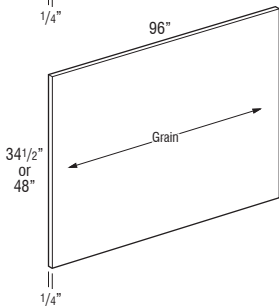
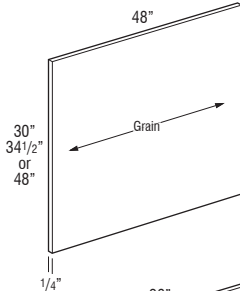
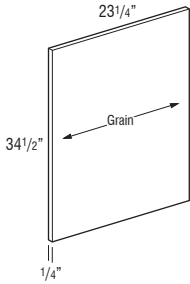
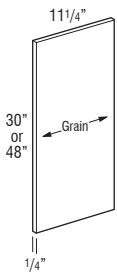

14PANEL11.2530P	184
14PANEL11.2548P	381

14PANEL2334.5P	297
-----------------------	-----

14PANEL4830P	450
---------------------	-----

14PANEL4834.5P	524
-----------------------	-----

14PANEL4848P†	577
----------------------	-----

14PANEL9634.5P†	974
------------------------	-----

14PANEL9648P†	1099
----------------------	------

- For use with Horizontal Grain doors.
- 1/4" thick laminated MDF.
- 15 day Express Response not available on items 48" and greater.

Custom Modifications

ID	RD

Finish Techniques

Heirlooming

Species Availability

Rustic Alder	Cherry	Rustic Hickory	Laminate	Maple	Oak
			•		

DESCRIPTION

**HORIZONTAL GRAIN
3/4" PANEL, PREMIUM**

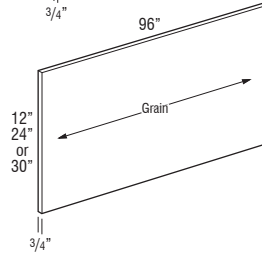
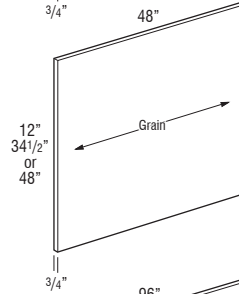
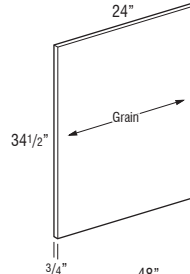
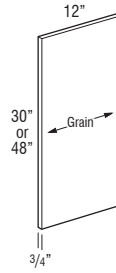

MODEL

34PANEL1230P	301
34PANEL1248P	541

34PANEL2434.5P	486
-----------------------	-----

34PANEL4812P	542
---------------------	-----

34PANEL4834.5P	606
-----------------------	-----

34PANEL4848P	666
---------------------	-----

34PANEL9612P†	758
----------------------	-----

34PANEL9624P†	1486
----------------------	------

34PANEL9630P†	1858
----------------------	------

- For use with Horizontal Grain doors.
- 3/4" thick laminated MDF.
- 34PANEL4812P and 34PANEL9612P recommended for exterior shelf material.
- Edgebanded on one short side and one long side only. Other edges will require moulding if exposed.
- 15 day Express Response not available on items greater than 48".

Custom Modifications

ID	RD

Finish Techniques

Heirlooming

Species Availability

Rustic Alder	Cherry	Rustic Hickory	Laminate	Maple	Oak
			•		

END PANELS, WALL

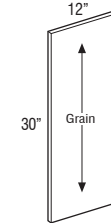

3/4" Finished

WEP1230WD	150
------------------	-----

3/4" White Laminate

WEP1230LAM ♦	102
---------------------	-----

- WEP1230WD in Stains: 3/4" thick veneered furniture board.
- WEP1230WD in Paints: 3/4" thick veneered or solid furniture board.
- WEP1230LAM is 3/4" thick laminated furniture board (white only).
- Panels are finished on two sides and front edge.

Custom Modifications

ID	RD	APC	MIP
Laminate	•	•	
Wood	•	•	•

Finish Techniques

Heirlooming

Species Availability

Rustic Alder	Cherry	Rustic Hickory	Laminate	Maple	Oak
Alder	•	Hickory	box color	•	•

♦ Only available in White laminate.

DESCRIPTION MODEL PRICE

END PANELS, PREMIUM - WALL



WEP1230P 302

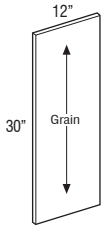

- For use with Vertical Grain doors.
- 3/4" thick laminated MDF.
- Front of panel and edgebanding on front, top, and bottom of panel will match doors.

Custom Modifications				Finish Techniques	
ID	RD	APC	MIP	Heirlooming	
•	•				

Species Availability					
Rustic Alder	Cherry	Rustic Hickory	Laminate	Maple	Oak
			•		

END PANELS, BASE



3/4" Finished

BEPWD 243

3/4" White Laminate

BEPLAM ♦ 165

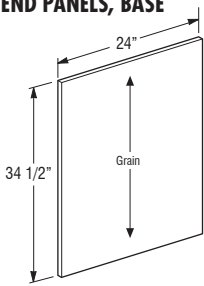

- BEPWD in Stains: 3/4" thick veneered furniture board.
- BEPWD in Paints: 3/4" thick veneered or solid furniture board.
- BEPLAM is 3/4" thick laminated furniture board (white only).
- Panels are finished on two sides and front edge.

Custom Modifications				Finish Techniques	
ID	RD	APC	MIP	Heirlooming	
Laminate	•	•			
Wood	•	•	•		

Species Availability					
Rustic Alder	Cherry	Rustic Hickory	Laminate	Maple	Oak
Alder	•	Hickory	box color	•	•

♦ Only available in White laminate.

END PANELS, PREMIUM - BASE



BEPP 484

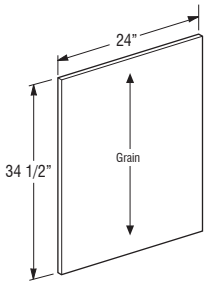

- For use with Vertical Grain doors.
- 3/4" thick laminated MDF.
- Both sides of panel and edgebanding on front of panel will match doors.

Custom Modifications				Finish Techniques	
ID	RD	APC	MIP	Heirlooming	
•	•				

Species Availability					
Rustic Alder	Cherry	Rustic Hickory	Laminate	Maple	Oak
			•		

END PANELS, LAZY SUSAN



1/2" Finished

BLSBEPWD 243

1/2" Laminate

BLSBEPLAM 165

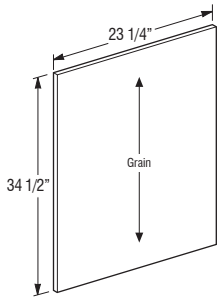

- BLSBEPWD: 1/2" thick veneered plywood.
- BLSBEPLAM: 1/2" thick furniture board with matching laminate exterior. Not available in finishes that don't have matching laminate ends available. See Finish Availability section for matching laminate end exceptions.
- All panels have Natural Maple laminate interior.

Custom Modifications				Finish Techniques	
ID	RD	APC	MIP	Heirlooming	
Laminate	•	•			
Wood	•	•	STD		

Species Availability					
Rustic Alder	Cherry	Rustic Hickory	Laminate	Maple	Oak
Alder	•	Hickory	box color	•	•

DESCRIPTION MODEL PRICE

END PANELS, TALL



3/4" Finished

TEP1248WD 271

TEP1296WD† 379

TEP12102WD† ♦♦ 569

TEP12108WD† ♦♦ 588

TEP12120WD† ♦♦ 647

3/4" White Laminate

TEP1248LAM ♦ 149

TEP1296LAM† ♦ 214

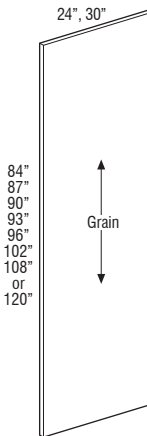
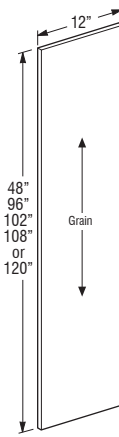

3/4" Finished

TEP2484WD†¹ 531

TEP2487WD†¹ 586

TEP2490WD†¹ 641

TEP2493WD†¹ 744

TEP2496WD†¹ 744

TEP24102WD† ♦♦ 1114

TEP24108WD† ♦♦ 1149

TEP24120WD† ♦♦ 1264

3/4" White Laminate

TEP2484LAM† ♦ 290

TEP2487LAM† ♦ 323

TEP2490LAM† ♦ 356

TEP2493LAM† ♦ 417

TEP2496LAM† ♦ 417

3/4" Finished

TEP3084WD† 690

TEP3096WD† 967

3/4" White Laminate

TEP3084LAM† ♦ 377

TEP3096LAM† ♦ 542

- TEP__WD in Stains: 3/4" thick veneered furniture board.
- TEP__WD in Paints: 3/4" thick veneered or solid furniture board.
- TEP__LAM is 3/4" thick laminated furniture board (white only).
- Panels are finished on two sides and front edge.
- 102", 108", and 120" will be MIP standard.

- 15 day Express Response not available on items greater than 48".

- 15 day Express Response not available on items greater than 48".

Custom Modifications				Finish Techniques	
ID	RD	APC	MIP	Heirlooming	
Laminate	•	•			
Wood	•¹	•	•		

¹Tall wood panels will be plywood when ID31-ID36 is specified.

Species Availability					
Rustic Alder	Cherry	Rustic Hickory	Laminate	Maple	Oak
Alder	•	Hickory	box color	•	•

♦ Only available in White laminate.

♦♦ Only available in Maple.

DESCRIPTION

END PANELS, PREMIUM - TALL

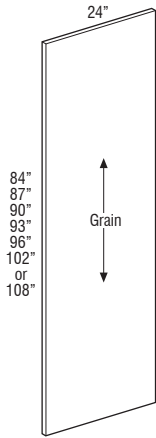
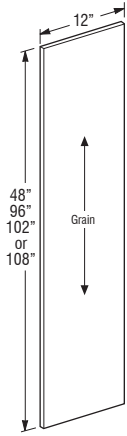

MODEL

TEP1248P	542
TEP1296P†	758
TEP12102P†	1137
TEP12108P†	1137
TEP2484P†	1062
TEP2487P†	1173
TEP2490P†	1280
TEP2493P†	1485
TEP2496P†	1485
TEP24102P†	2229
TEP24108P†	2229

- For use with Vertical Grain doors.
- 3/4" thick laminated MDF.
- Both sides of panel and edgebanding on front of panel will match doors.

†5 day Express Response not available on items greater than 48".

Custom Modifications

ID	RD
•	•

Finish Techniques

Heirlooming

¹ID available on TEP2484P-TEP2496P up to 30". ID not available on TEP24102P and TEP24108P.

Species Availability

Rustic Alder	Cherry	Rustic Hickory	Laminate	Maple	Oak
			•		

¹TEP12102P, TEP12108P, TEP24102P, and TEP24108P not available in certain laminate finishes. See Finish Availability section for exception notes.

END PANELS, VANITY

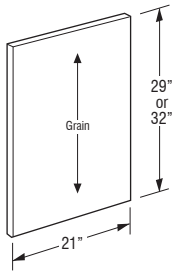

3/4" Finished

VBEP2129WD	243
VBEP2132WD	243

3/4" White Laminate

VBEP2129LAM ♦	165
VBEP2132LAM ♦	165

- VBEP__WD in Stains: 3/4" thick veneered furniture board.
- VBEP__WD in Paints: 3/4" thick veneered or solid furniture board.
- VBEP__LAM is 3/4" thick laminated furniture board (white only).
- Panels are finished on two sides and front edge.

Custom Modifications

ID	RD	APC	MIP
•	•		
•	•	•	

Finish Techniques

Heirlooming

Species Availability

Rustic Alder	Cherry	Rustic Hickory	Laminate	Maple	Oak
Alder	•	Hickory	box color	•	•

♦ Only available in White laminate.

DESCRIPTION

WALL PANEL with FILLER ATTACHED

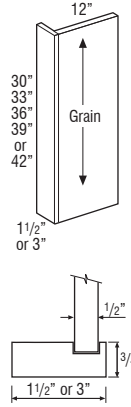

MODEL

1/2" Finished	
WEP1230F1.5WD	279
WEP1230F3WD	312
WEP1233F1.5WD	296
WEP1233F3WD	327
WEP1236F1.5WD	309
WEP1236F3WD	345
WEP1239F1.5WD	340
WEP1239F3WD	377
WEP1242F1.5WD	372
WEP1242F3WD	419
1/2" Laminate	
WEP1230F1.5LAM ♦	223
WEP1230F3LAM ♦	250
WEP1233F1.5LAM ♦	236
WEP1233F3LAM ♦	263
WEP1236F1.5LAM ♦	248
WEP1236F3LAM ♦	274
WEP1239F1.5LAM ♦	271
WEP1239F3LAM ♦	305
WEP1242F1.5LAM ♦	300
WEP1242F3LAM ♦	334

- WEP__F_WD in Stains: 1/2" thick veneered furniture board.
- WEP__F_WD in Paints: 1/2" thick veneered or solid furniture board.
- WD panels have Natural Maple laminate interior. Specify MIP for matching veneered interior.
- WEP__F_LAM is 1/2" thick laminated furniture board.
- All panels have Natural Maple laminate interior.

Custom Modifications

ID	RD	APC	MIP
•	•		
•	•	•	•

Finish Techniques

Heirlooming

Species Availability

Rustic Alder	Cherry	Rustic Hickory	Laminate	Maple	Oak
Alder	•	Hickory	box color	•	•

♦ Not available in finishes that don't have matching laminate ends available. See Finish Availability section for matching laminate end exceptions.

DESCRIPTION

MODEL

PRICE

BASE and TALL PANELS with FILLER ATTACHED

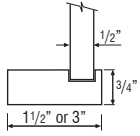
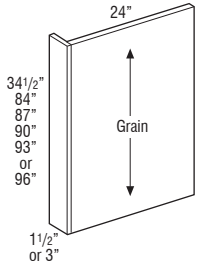

1/2" Finished	
BEPF1.5WD	306
BEPF3WD	334
1/2" Laminate	
BEPF1.5LAM ♦	237
BEPF3LAM ♦	267

1/2" Finished	
TEP2484F1.5WD †	625
TEP2484F3WD †	694
TEP2487F1.5WD †	690
TEP2487F3WD †	765
TEP2490F1.5WD †	749
TEP2490F3WD †	834
TEP2493F1.5WD †	876
TEP2493F3WD †	973
TEP2496F1.5WD †	876
TEP2496F3WD †	973

1/2" Laminate	
TEP2484F1.5LAM † ♦	404
TEP2484F3LAM † ♦	448
TEP2487F1.5LAM † ♦	448
TEP2487F3LAM † ♦	497
TEP2490F1.5LAM † ♦	489
TEP2490F3LAM † ♦	545
TEP2493F1.5LAM † ♦	577
TEP2493F3LAM † ♦	644
TEP2496F1.5LAM † ♦	577
TEP2496F3LAM † ♦	644

- BEPF_WD and TEP__F_WD in Stains: 1/2" thick veneered furniture board.
 - BEPF_WD and TEP__F_WD in Paints: 1/2" thick veneered or solid furniture board.
 - WD panels have Natural Maple laminate interior. Specify MIP for matching veneered interior.
 - BEPF_LAM and TEP__F_LAM is 1/2" thick laminated furniture board.
 - All panels have Natural Maple laminate interior.
- †5 day Express Response not available on items greater than 48".

Custom Modifications				Finish Techniques
ID	RD	APC	MIP	Heirlooming
Laminate	•	•	•	
Wood	•	•	•	

Species Availability					
Rustic Alder	Cherry	Rustic Hickory	Laminate	Maple	Oak
Alder	•	Hickory	box color	•	•

♦ Not available in finishes that don't have matching laminate ends available. See Finish Availability section for matching laminate end exceptions.

DESCRIPTION

MODEL

PRICE

TALL PANELS with FILLER ATTACHED, 102", 108", & 120" TALL

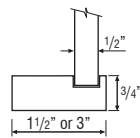
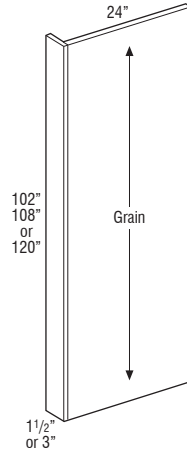

1/2" Finished	
TEP24102F1.5WD	1314
TEP24102F3WD	1460
TEP24108F1.5WD	1314
TEP24108F3WD	1460
TEP24120F1.5WD	1446
TEP24120F3WD	1606

- 1/2" thick veneered plywood.
- Panel will have veneered exterior and Natural Maple laminated interior.

Custom Modifications			Finish Techniques
APC	ID	RD	Heirlooming
STD		•	

Species Availability					
Rustic Alder	Cherry	Rustic Hickory	Laminate	Maple	Oak
			box color	•	

WALL PANEL with FILLER ATTACHED and FURNITURE ENDS

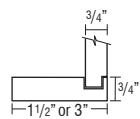
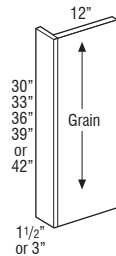

WEP1230F1.5FPE	316
WEP1230F3FPE	355
WEP1233F1.5FPE	332
WEP1233F3FPE	372
WEP1236F1.5FPE	348
WEP1236F3FPE	391
WEP1239F1.5FPE	381
WEP1239F3FPE	428
WEP1242F1.5FPE	422
WEP1242F3FPE	472

- 3/4" thick veneered plywood.
- Panel will have veneered exterior and Natural Maple laminated interior.
- Specify MIP for matching veneered interior.

Custom Modifications				Finish Techniques	
APC	FPFB	ID	RD	MIP	Heirlooming
STD	•	•	•	•	

Species Availability					
Rustic Alder	Cherry	Rustic Hickory	Laminate	Maple	Oak
Alder	•	Hickory	box color	•	•

DESCRIPTION

BASE and TALL PANELS with FILLER ATTACHED and FURNITURE ENDS

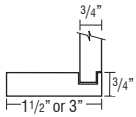
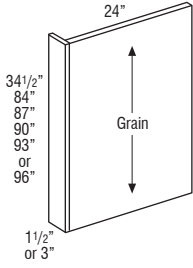

MODEL

PRICE

BEPF1.5FPE	351
BEPF3FPE	383
TEP2484F1.5FPE†	720
TEP2484F3FPE†	799
TEP2487F1.5FPE†	831
TEP2487F3FPE†	879
TEP2490F1.5FPE†	864
TEP2490F3FPE†	961
TEP2493F1.5FPE†	1009
TEP2493F3FPE†	1118
TEP2496F1.5FPE†	1009
TEP2496F3FPE†	1118

- 3/4" thick veneered plywood.
 - Panel will have veneered exterior and Natural Maple laminated interior.
- †5 day Express Response not available on items greater than 48".

Custom Modifications

APC	FPFB	ID	RD	MIP
	STD	•	•	•

Finish Techniques

Heirlooming

Species Availability

Rustic Alder	Cherry	Rustic Hickory	Laminate box color	Maple	Oak
	•	Hickory		•	•

TALL PANELS with FILLER ATTACHED and FURNITURE ENDS

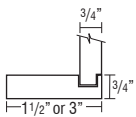
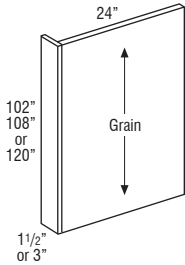

TEP24102F1.5FPE	1514
TEP24102F3FPE	1678
TEP24108F1.5FPE	1514
TEP24108F3FPE	1678
TEP24120F1.5FPE	1666
TEP24120F3FPE	1846

- 3/4" thick veneered plywood.
- Panel will be two-sided veneer.

Custom Modifications

APC	FPFB	ID	RD	MIP
		•	•	STD

Finish Techniques

Heirlooming

Species Availability

Rustic Alder	Cherry	Rustic Hickory	Laminate	Maple	Oak
				•	

DESCRIPTION

WALL PANEL with FILLER ATTACHED and AUTHENTIC ENDS

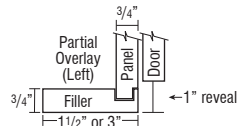
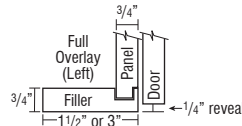
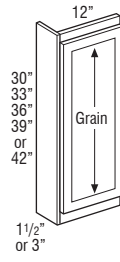

MODEL

PRICE

WEP1230F1.5AEL	464
WEP1230F1.5AER	464
WEP1230F3AEL	516
WEP1230F3AER	516
WEP1233F1.5AEL	485
WEP1233F1.5AER	485
WEP1233F3AEL	542
WEP1233F3AER	542
WEP1236F1.5AEL	510
WEP1236F1.5AER	510
WEP1236F3AEL	568
WEP1236F3AER	568
WEP1239F1.5AEL	559
WEP1239F1.5AER	559
WEP1239F3AEL	624
WEP1239F3AER	624
WEP1242F1.5AEL	614
WEP1242F1.5AER	614
WEP1242F3AEL	690
WEP1242F3AER	690

- 3/4" thick veneered plywood with doors attached.
- Depth can be increased in 3" increments up to 24" deep.
- Panel will have veneered exterior and Natural Maple laminated interior standard. Specify MIP for matching veneered interior.

Custom Modifications

APC	DPSRR	FPFB	ID	RD	MFO	MIP
		STD	•	•	•	•

Finish Techniques

Heirlooming
•

Species Availability

Rustic Alder	Cherry	Rustic Hickory	Laminate box color	Maple	Oak
	•	Hickory		•	•

DESCRIPTION MODEL PRICE

BASE PANEL with FILLER ATTACHED and AUTHENTIC ENDS



BEPF1.5AEL	927
BEPF1.5AER	927
BEPF3AEL	960
BEPF3AER	960

- 3/4" thick veneered plywood with doors attached.
- Depth can be increased in 3" increments up to 36" deep.
- Panel will have veneered exterior and Natural Maple laminated interior standard. Specify MIP for matching veneered interior.

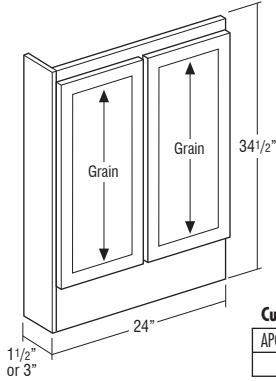

Custom Modifications

APC	DPSRR	FPEB	ID	RD	MFO	MIP
	•	STD	•			•

Finish Techniques

Heirlooming
•

Species Availability

Rustic Alder	Cherry	Rustic Hickory	Laminate	Maple	Oak
	•	Hickory	box color	•	•

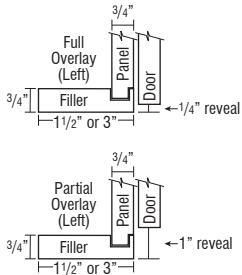

BASE PANEL with FILLER ATTACHED and AUTHENTIC ENDS, SINGLE DOOR



BEPF1.5AELSD	927
BEPF1.5AERSD	927
BEPF3AELSD	960
BEPF3AERSD	960

- 3/4" thick veneered plywood with doors attached.
- Depth can be reduced in 3" increments down to 9" deep.
- Panel will have veneered exterior and Natural Maple laminated interior standard. Specify MIP for matching veneered interior.

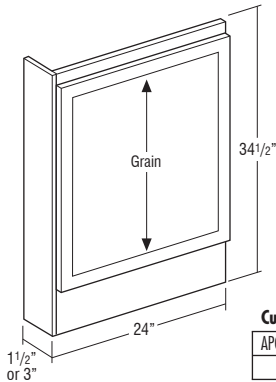

Custom Modifications

APC	DPSRR	FPEB	ID	RD	MFO	MIP
	•	STD	•			•

Finish Techniques

Heirlooming
•

Species Availability

Rustic Alder	Cherry	Rustic Hickory	Laminate	Maple	Oak
	•	Hickory	box color	•	•

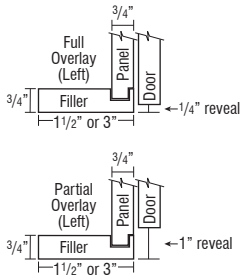

DESCRIPTION MODEL PRICE

TALL PANEL with FILLER ATTACHED and AUTHENTIC ENDS

TEP2484F1.5AEL	2116
TEP2484F1.5AER	2116
TEP2484F3AEL	2187
TEP2484F3AER	2187
TEP2487F1.5AEL	2181
TEP2487F1.5AER	2181
TEP2487F3AEL	2257
TEP2487F3AER	2257
TEP2490F1.5AEL	2243
TEP2490F1.5AER	2243
TEP2490F3AEL	2326
TEP2490F3AER	2326
TEP2493F1.5AEL	2369
TEP2493F1.5AER	2369
TEP2493F3AEL	2466
TEP2493F3AER	2466
TEP2496F1.5AEL	2369
TEP2496F1.5AER	2369
TEP2496F3AEL	2466
TEP2496F3AER	2466

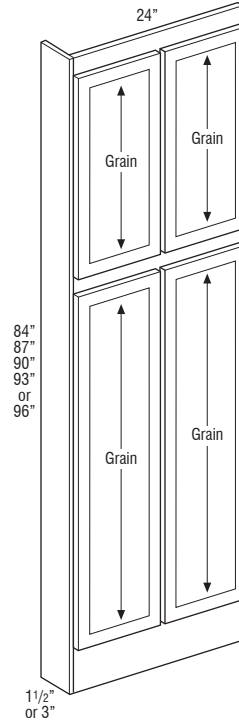

- 3/4" thick veneered plywood with doors attached.
- Depth can be increased in 3" increments up to 36" deep.
- Panel will have veneered exterior and Natural Maple laminated interior standard. Specify MIP for matching veneered interior.

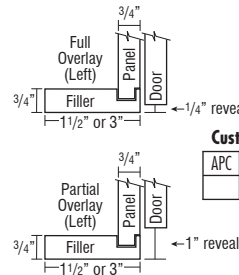

Custom Modifications

APC	DPSRR	FPEB	ID	RD	MFO	MIP	INVFRM
	•	STD	•	•	•	•	•

Finish Techniques

Heirlooming
•

Species Availability

Rustic Alder	Cherry	Rustic Hickory	Laminate	Maple	Oak
	•	Hickory	box color	•	•

DESCRIPTION

MODEL

PRICE

TALL PANEL with FILLER ATTACHED and AUTHENTIC ENDS, SINGLE DOOR

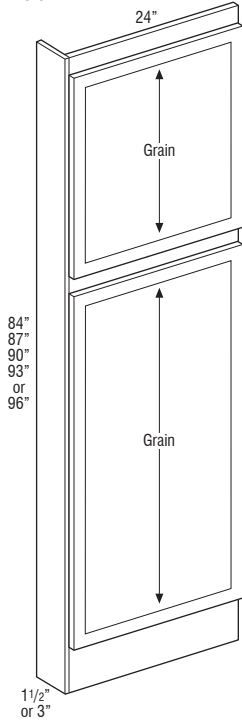

TEP84F1.5AELSD	2116
TEP84F1.5AERSD	2116
TEP84F3AELSD	2187
TEP84F3AERSD	2187
TEP87F1.5AELSD	2181
TEP87F1.5AERSD	2181
TEP87F3AELSD	2257
TEP87F3AERSD	2257
TEP90F1.5AELSD	2243
TEP90F1.5AERSD	2243
TEP90F3AELSD	2326
TEP90F3AERSD	2326
TEP93F1.5AELSD	2369
TEP93F1.5AERSD	2369
TEP93F3AELSD	2466
TEP93F3AERSD	2466
TEP96F1.5AELSD	2369
TEP96F1.5AERSD	2369
TEP96F3AELSD	2466
TEP96F3AERSD	2466

- 3/4" thick veneered plywood with doors attached.
- Depth can be reduced in 3" increments down to 9" deep.
- On non-mitered doors, the tall door on the bottom will have two vertical panels.
- Panel will have veneered exterior and Natural Maple laminated interior standard. Specify MIP for matching veneered interior.

Custom Modifications

APC	DPSRR	FPEB	ID	RD	MFO	MIP	INVFRM
			•		•	•	•
			•				

Finish Techniques

Heirlooming
•

Species Availability

Rustic Alder	Cherry	Rustic Hickory	Laminate box color	Maple	Oak
	•	Hickory		•	•

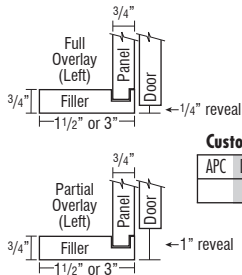

VANITY DESK LEGS

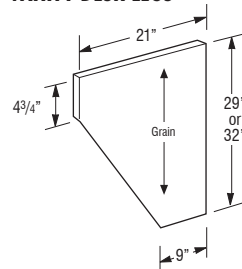

VDL2129WD	235
VDL2132WD	235

- All panels are finished 2 sides and front edge.
- VDL_ _WD in Stains: 3/4" thick veneered furniture board.
- VDL_ _WD in Paints: 3/4" thick veneered or solid furniture board.

Custom Modifications

ID	RD

Finish Techniques

Heirlooming

Species Availability

Rustic Alder	Cherry	Rustic Hickory	Laminate box color	Maple	Oak
	•	Hickory		•	•

DESCRIPTION

MODEL

PRICE

WOOD V-GROOVED with TRIPLE BEADED FRONT 3/4" PANELS

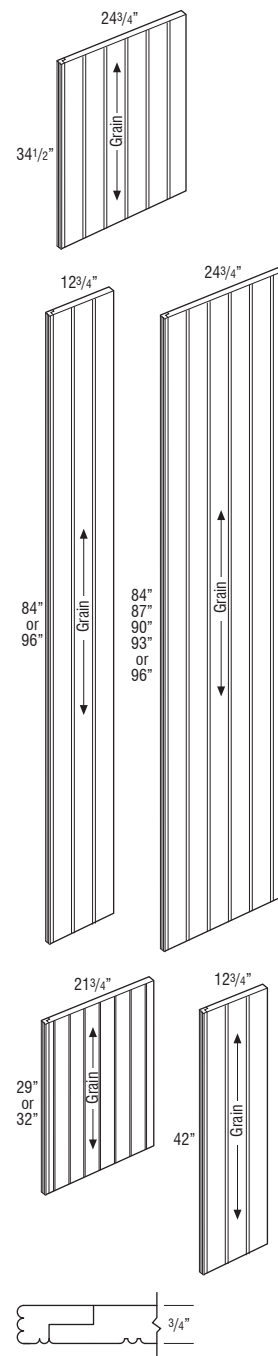

MODEL	Depth	PRICE
BEPVG (34 1/2")	24 3/4"	478
TEP1284VG†	12 3/4"	426
TEP1296VG†	12 3/4"	607
TEP84VG†	24 3/4"	1036
TEP87VG†	24 3/4"	1072
TEP90VG†	24 3/4"	1105
TEP93VG†	24 3/4"	1175
TEP96VG†	24 3/4"	1175
VBEP29VG	21 3/4"	478
VBEP32VG	21 3/4"	478
WEP42VG	12 3/4"	395

- Veneer on MDF core.
 - V-groove on 3" centers.
- †5 day Express Response not available on items greater than 48".

Custom Modifications

ID	RD

Finish Techniques

Heirlooming
•

Species Availability

Rustic Alder	Cherry	Rustic Hickory	Laminate box color	Maple	Oak
				•	

DESCRIPTION MODEL PRICE

DECORATIVE DOOR PANEL KIT Base End



BED	644
BEDSD	644

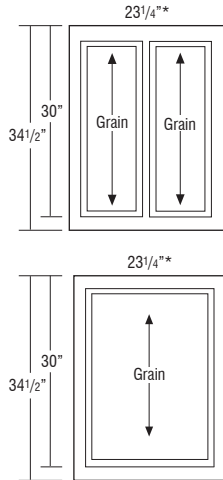

- Door panel kits include Base End Panel Skin, unattached door(s) and attachment screws. Field installation required.
 - Not compatible on cabinets specified with FPEB. Use Authentic Ends modification for decorative doors with FPEB.
- *Width shown in each image is panel width. For Full Overlay doors, total door width is 1/2" greater than panel width. When installed on the side of a cabinet as intended, the Full Overlay door will extend over the cabinet face frame edge. Partial Overlay doors have a 1" reveal, so they would not overlap the frame.

Custom Modifications				Finish Techniques	
DPSRR	ID	RD	MFO	Heirlooming	
•				•	

Species Availability					
Rustic Alder	Cherry	Rustic Hickory	Laminate	Maple	Oak
	•	Hickory	box color	•	•

DECORATIVE DOOR PANEL KIT Tall End

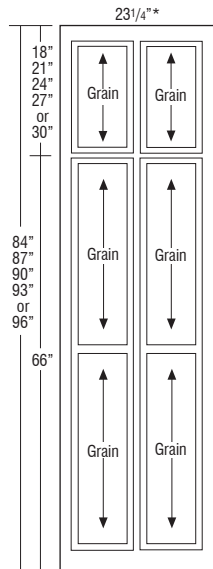

TED2484	1483
TED2487	1512
TED2490	1536
TED2493	1586
TED2496	1586

TED2484SD	1483
TED2487SD	1512
TED2490SD	1536
TED2493SD	1586
TED2496SD	1586

- Door panel kits include Tall End Panel Skin, unattached door(s) and attachment screws. Field installation required.
 - Not compatible on cabinets specified with FPEB. Use Authentic Ends modification for decorative doors with FPEB.
 - On non-mitered doors, the tall door on the bottom will have two vertical panels.
- *Width shown in each image is panel width. For Full Overlay doors, total door width is 1/2" greater than panel width. When installed on the side of a cabinet as intended, the Full Overlay door will extend over the cabinet face frame edge. Partial Overlay doors have a 1" reveal, so they would not overlap the frame.

Custom Modifications				Finish Techniques	
DPSRR	ID	RD	MFO	Heirlooming	
•				•	

Species Availability					
Rustic Alder	Cherry	Rustic Hickory	Laminate	Maple	Oak
	•	Hickory	box color	•	•

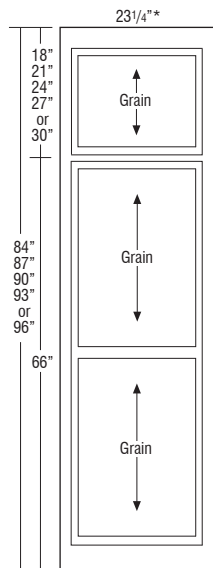

DESCRIPTION MODEL PRICE

DECORATIVE DOOR PANEL KIT Wall End



WED1218	348
WED1221	372
WED1224	400
WED1227	428
WED1230	455
WED1233	477
WED1236	496
WED1239	540
WED1242	540

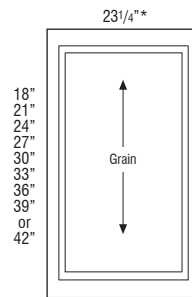
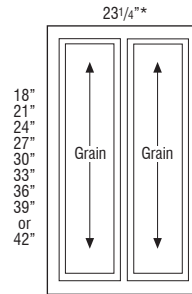
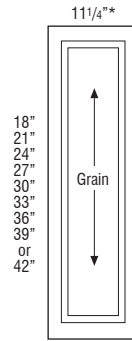

WED2418	592
WED2421	599
WED2424	612
WED2427	624
WED2430	642
WED2433	665
WED2436	692
WED2439	728
WED2442	728

WED2418SD	592
WED2421SD	599
WED2424SD	612
WED2427SD	624
WED2430SD	642
WED2433SD	665
WED2436SD	692
WED2439SD	728
WED2442SD	728

- Door panel kits include Wall End Panel Skin, unattached door(s) and attachment screws. Field installation required.
 - Custom door sizes not available.
- *Width shown in each image is panel width. For Full Overlay doors, total door width is 1/2" greater than panel width. When installed on the side of a cabinet as intended, the Full Overlay door will extend over the cabinet face frame edge. Partial Overlay doors have a 1" reveal, so they would not overlap the frame.

Custom Modifications				Finish Techniques	
DPSRR	ID	RD	MFO	Heirlooming	
•				•	

Species Availability					
Rustic Alder	Cherry	Rustic Hickory	Laminate	Maple	Oak
	•	Hickory	box color	•	•

WAINSCOTING, 34 1/2" or 40 1/2" HIGH

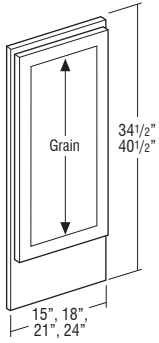

WAIN1534.5-WAIN2440.5

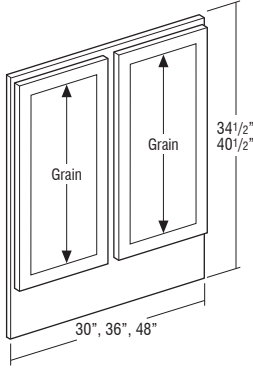

WAIN3034.5-WAIN4840.5

Price Point	1	2	3	4	5	6	7	8	9	10	11	12
WAIN1534.5	605	608	638	669	699	729	774	805	837	867	889	967
WAIN1834.5	626	629	666	702	739	775	824	855	887	922	945	1024
WAIN2134.5	681	684	724	763	802	840	888	926	965	999	1026	1109
WAIN2434.5	834	839	862	885	908	931	987	1026	1070	1104	1137	1231
WAIN1540.5	1161	1167	1186	1205	1224	1242	1295	1336	1375	1411	1438	1536
WAIN1840.5	1184	1189	1214	1239	1263	1288	1345	1387	1425	1465	1494	1592
WAIN2140.5	1240	1247	1273	1300	1327	1353	1411	1458	1503	1542	1574	1677
WAIN2440.5	1392	1399	1410	1421	1432	1444	1508	1558	1607	1648	1686	1799

WAIN3034.5	963	968	1017	1066	1116	1164	1236	1288	1337	1384	1420	1540
WAIN3634.5	1020	1026	1082	1138	1194	1250	1326	1378	1432	1483	1525	1654
WAIN4834.5	1242	1249	1325	1400	1475	1550	1642	1708	1776	1841	1894	2052
WAIN3040.5	1530	1538	1566	1594	1622	1650	1730	1788	1844	1894	1939	2075
WAIN3640.5	1594	1602	1639	1674	1710	1746	1833	1895	1957	2010	2059	2205
WAIN4840.5	2041	2051	2081	2111	2141	2171	2276	2355	2433	2501	2555	2737

WAIN6034.5	1464	1472	1567	1661	1756	1850	1958	2037	2122	2201	2262	2449
WAIN6040.5	2489	2501	2526	2549	2573	2596	2719	2815	2910	2989	3052	3270

WAIN7234.5	1687	1696	1810	1923	2036	2149	2274	2368	2468	2559	2631	2848
WAIN7240.5	2936	2950	2968	2986	3004	3021	3163	3275	3386	3479	3548	3801

- Full Overlay Styles only.
- Panel is 1 1/2" thick including doors. Non-operating doors are applied to 3/4" thick rail and stile frame.
- Flush Toekick standard.
- Wainscoting panel backs are not finished, but are sealed to prevent warping and cracking.
- All faces and edges will be finished.
- For use on bars or islands, attach panel by securing the panel face frame through the inside of the applicable cabinet.
- For wall applications, the screw heads used for the panel face frame attachment to the wall can be concealed behind the doors and drawer fronts.

Product Code	Overall Width	Number of Doors	Number of Frame Center Stiles	Door Width
WAIN15..	15"	1	0	14 1/2"
WAIN18..	18"	1	0	17 1/2"
WAIN21..	21"	1	0	20 1/2"
WAIN24..	24"	1	0	23 1/2"
WAIN30..	30"	2	1	14 1/2"
WAIN36..	36"	2	1	17 1/2"
WAIN48..	48"	2	1	23 1/2"
WAIN60..	60"	4	3	14 1/2"
WAIN72..	72"	3	2	23 1/2"

Door height on 34 1/2" high panels is 29 1/2".
 Door height on 40 1/2" high panels is 35 1/2".

Custom Modifications

EX	FTK	VTK
•	STD	•

Door Options

DPSRR
•

Finish Techniques

Heirlooming
•

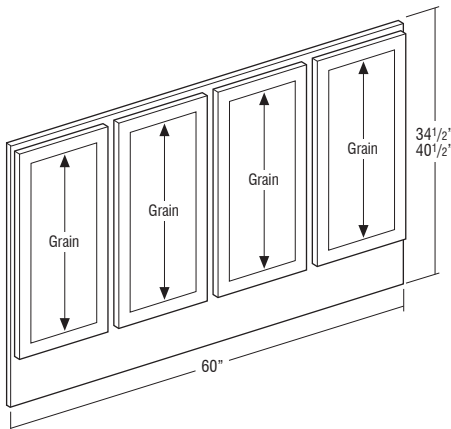

WAIN6034.5-WAIN6040.5

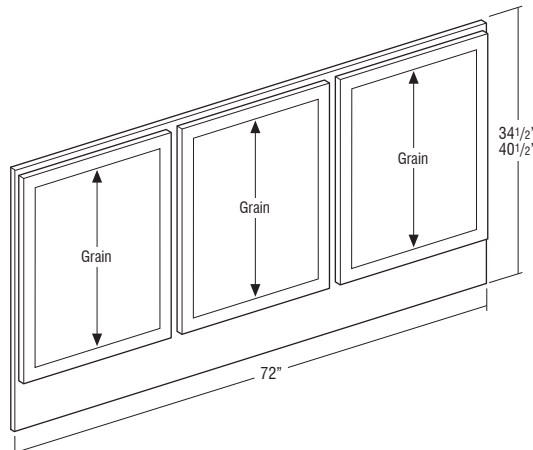

WAIN7234.5-WAIN7240.5

DESCRIPTION MODEL PRICE
CUSTOM ISLAND PANELS

Custom 3/4" Island Back Panels, Cross Grain Veneer

ISLBPNL3/4CRSGR \$62 /sq ft

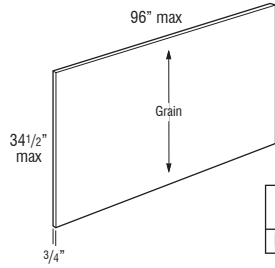

- 3/4" thick furniture board core veneer panel finished on both sides.
- Matching veneer edgebanding on two height and one width edge.
- Grain on panels runs the height dimension (vertical).
- Custom sizes available in 1/16" increments.

Model	Grain Direction	Maximum Width	Minimum Width	Maximum Height	Minimum Height
ISLBPNL3/4CRSGR	Vertical	96"	12"	34 1/2"	12"

Finish Techniques

Heirlooming

Species Availability

Rustic Alder	Cherry	Rustic Hickory	Laminate	Maple	Oak
	•		box color	•	

CUSTOM PANELS, DOORS, & DRAWER FRONTS

All custom panels and doors can be ordered through 20/20. For manual orders, please use the Decorative Appliance Panel Request Form. See Policies section for information on where that form can be found.

Due to customized ordering, Decorative Appliance Panels may not be returned.

Custom Panels & Doors (DAPNL.. and DADOOR..) square footage requirements are calculated by multiplying the height and width for each panel and door (square footage = width x height (in inches)/144). Premium finish upcharge will be applied.

Custom Panels

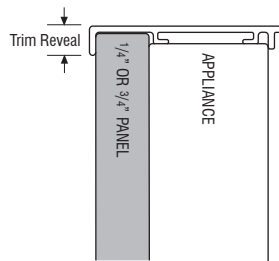

DAPNL1/4 \$44 /sq ft

DAPNL3/4 \$62 /sq ft

- DAPNL1/4 includes 1/4" finished veneer on MDF core, panel cut to fit appliance doors. Panels mount to the appliance using trim kits provided by the appliance supplier.
- DAPNL1/4 is finished on face only, edges are not finished.
- DAPNL3/4 kit includes 3/4" furniture board core veneer panel finished on both sides, and all four edges. Panel is cut to fit appliance doors, and mounts to the appliance using trim kits provided by the appliance supplier.
- Custom sizes available in 1/16" increments.
- DAPNL3/4 can be ordered in APC.

	Maximum Width	Minimum Width	Maximum Height	Minimum Height
DAPNL1/4	48"	5"	96"	5"
DAPNL3/4*	48"	5"	48"	5"
DAPNL3/4**	30"	5"	96"	5"

*If DAPNL3/4 is 48" high or less
 **If DAPNL3/4 is greater than 48" high
 Grain on panels will follow the height dimension (vertical)

Finish Techniques

Heirlooming

Species Availability

Rustic Alder	Cherry	Rustic Hickory	Laminate	Maple	Oak
Alder	•	Hickory	box color	•	•

DESCRIPTION MODEL PRICE

Custom Panels, Premium, Vertical

DAPNL1/4P \$88 /sq ft

DAPNL3/4P \$122 /sq ft

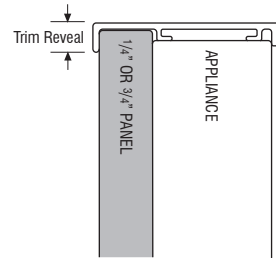

- DAPNL1/4P is a 1/4" thick laminated MDF panel cut to fit appliance doors. Laminated on face only, edges are not finished.
- DAPNL3/4P is a 3/4" thick laminated MDF panel. Vertical grain panels are laminated on both sides with edgebanding on all four edges.
- DAPNL1/4P and DAPNL3/4P are available for use with certain laminate doors. See Door Style section for availability.
- Panel is cut to fit appliance doors, and mounts to the appliance using trim kits provided by the appliance supplier.
- Custom sizes available in 1/16" increments.

Model	Panel Type	Maximum Width	Minimum Width	Maximum Height	Minimum Height
DAPNL1/4P	Vertical Grain or High Gloss	48"	5"	96"	5"
DAPNL3/4P (48" high or less)	Vertical Grain or High Gloss	48"	5"	48"	5"
DAPNL3/4P (>48" high)	Vertical Grain or High Gloss	30"	5"	96"	5"

Finish Techniques

Heirlooming

Species Availability

Rustic Alder	Cherry	Rustic Hickory	Laminate	Maple	Oak
			•		

Custom Panels, Premium, Horizontal

DAPNL1/4HGP \$88 /sq ft

DAPNL3/4HGP \$122 /sq ft

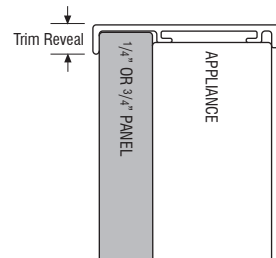

- DAPNL1/4HGP is a 1/4" thick laminated MDF panel cut to fit appliance doors. Laminated on face only, edges are not finished.
- DAPNL3/4HGP is a 3/4" thick laminated MDF panel. Horizontal grain panels are laminated on both sides with edgebanding on all four edges.
- DAPNL1/4HGP and DAPNL3/4HGP are available for use with horizontal grain laminate doors.
- Panel is cut to fit appliance doors, and mounts to the appliance using trim kits provided by the appliance supplier.
- Custom sizes available in 1/16" increments.

Model	Panel Type	Maximum Width	Minimum Width	Maximum Height	Minimum Height
DAPNL1/4HGP	Horizontal Grain	96"	5"	48"	5"
DAPNL3/4HGP	Horizontal Grain	48"	5"	48"	5"
DAPNL3/4HGP (>48" wide)	Horizontal Grain	96"	5"	30"	5"

Finish Techniques

Heirlooming

Species Availability

Rustic Alder	Cherry	Rustic Hickory	Laminate	Maple	Oak
			•		

DESCRIPTION

MODEL

PRICE

Custom Doors, No Hinge Routing

Overlay Application (with Backer Panel)

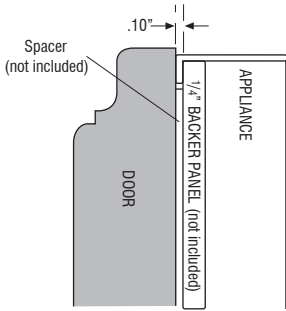

Overlay Application (no Backer Panel)

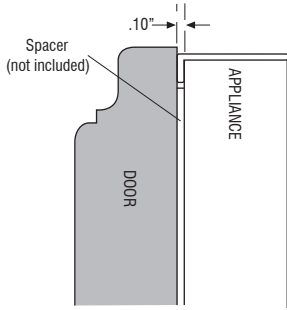

Framed Application

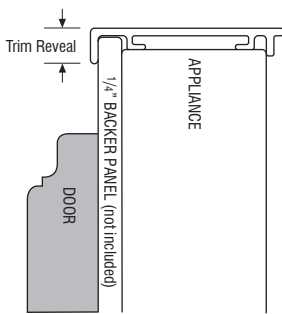

DADOORB

\$176 /sq ft

DADOORHG

\$176 /sq ft

- DADOORB is a custom sized door with a vertical grain center panel.
- DADOORHG is a custom sized door with a horizontal grain center panel. Stiles and rails are built as doors with a single center panel.
- DADOORHG will utilize a flat panel on raised panel styles when width or height is less than 10".
- Includes a 3/4" thick door made to a custom size for the appliance front. No backer panel included.
 - Some appliances require a .10" spacer and/or a 1/4" backer panel.
 - The 1/4" backer panel may be ordered separately (see DAPNLI/4).
- All doors will be specified "NO HINGE ROUTE". Backs may have identification marks, be unfinished, and have 3/16" diameter holes used during finish processing. For these reasons, these doors are not suitable for use as cabinet doors.
- DADOORB and DADOORHG are not available on certain door styles. See Door Style section for availability.
- Custom sizes available in 1/16" increments.
- CG modification available, maximum size is 23 1/2" x 43" for DADOORB and 43" x 23 1/2" for DADOORHG.
- Not available on MDF door styles. If desired for use with MDF, order as Maple.

Finish Techniques

Heirlooming
•

	Model	Door Style Type	Available Width Range*	Available Height Range*
	DADOORB	Non-mitered Styles	7 1/2" to 25 7/8" ** (<3" wide rails/stiles) 8 1/2" to 25 7/8" (3" wide rails/stiles)	7 1/2" to 47 7/16" (<3" wide rails/stiles) 8 1/2" to 47 7/16" (3" wide rails/stiles)
	DADOORB	Non-mitered Styles	7 1/2" to 25 7/8" ** (<3" wide rails/stiles) 8 1/2" to 25 7/8" (3" wide rails/stiles)	47 1/2" to 82" (<3" wide rails/stiles) 47 1/2" to 82" (3" wide rails/stiles)
	DADOORB	Non-mitered Styles	25 15/16" to 35 3/4" (<3" wide rails/stiles) 25 15/16" to 35 3/4" (3" wide rails/stiles)	7 1/2" to 47 7/16" (<3" wide rails/stiles) 8 1/2" to 47 7/16" (3" wide rails/stiles)
	DADOORB	Non-mitered Styles	25 15/16" to 35 3/4" (<3" wide rails/stiles) 25 15/16" to 35 3/4" (3" wide rails/stiles)	47 1/2" to 82" (<3" wide rails/stiles) 47 1/2" to 82" (3" wide rails/stiles)
	DADOORB	Mitered Styles	8" to 25 7/8"	8" to 61"
	DADOORHG	Non-mitered Styles	7 1/2" to 42 1/4" (<3" wide rails/stiles) 8 1/2" to 42 1/4" (3" wide rails/stiles)	7 1/2" to 23 3/4" (<3" wide rails/stiles) 8 1/2" to 23 3/4" (3" wide rails/stiles)
	DADOORHG	Mitered Styles	8" to 61"	8" to 24"

*Any door with a minimum width or height dimension less than 10" will receive a flat center panel.
 **In certain door styles, DADOORB has a maximum width of 23 1/2" for a single width center panel, doors between 23 9/16" and 35 3/4" wide have a center mullion between the center panels. See Door Style section for exceptions.

Custom Drawer Fronts

**5-piece Drawer Fronts:
DASPCDF**

\$176 /sq ft

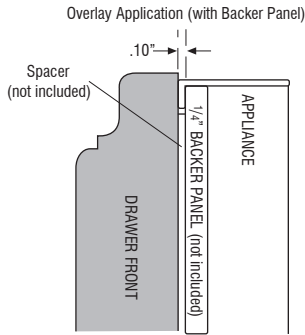

- DASPCDF is a custom sized 5-piece drawer front with a flat panel on raised panel styles when width or height is less than 10".
- DASPCDF is available on door styles where 5-piece drawer fronts are available as standard or optional. Requires a 5-piece drawer front selection, see chart below for available options.
- DASPCDF not available in certain door styles. See Door Style section for availability.
- Includes a 3/4" thick drawer front made to a custom size for the appliance front. No backer panel included.
 - Some appliances require a .10" spacer and/or a 1/4" backer panel.
 - The 1/4" backer panel may be ordered separately (see DAPNLI/4).
- Backs may have identification marks and have 3/16" diameter holes used during finish processing.
- Custom sizes available in 1/16" increments.

**Slab Drawer Fronts:
DASLBDF**

\$176 /sq ft

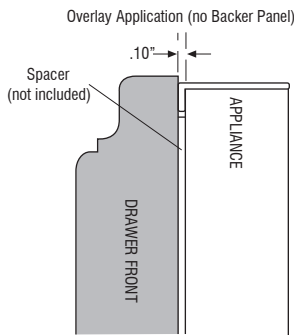

- DASLBDF is a custom sized slab drawer front.
- DASLBDF is available on door styles where slab drawer fronts are available as standard or optional. Requires a slab drawer front selection, see chart below for available options.
- DASLBDF not available in certain door styles. See Door Style section for availability.
- Includes a 3/4" thick drawer front made to a custom size for the appliance front. No backer panel included.
 - Some appliances require a .10" spacer and/or a 1/4" backer panel.
 - The 1/4" backer panel may be ordered separately (see DAPNLI/4).
- Backs may have identification marks and have 3/16" diameter holes used during finish processing.
- Custom sizes available in 1/16" increments.

Finish Techniques

Heirlooming	•
-------------	---

	Model	Drawer Front Type	Available Width Range	Available Height Range
	DASPCDF *	5-piece Drawer Front Non-mitered Styles	8 1/2" to 35 1/2" **	6 1/4" to 16 1/2"
	DASLBDF *	Slab Drawer Front	7" to 47 1/2"	5 1/2" to 17"

*See Door Style section for grain direction exceptions on certain door styles.

**See Door Style section for Maximum Width exceptions on certain door styles.

Drawer Front Options

	DF5PC	DF5PCNR	DFSLB	DF5PCSLBT	DF5PCNRST	DFSLBT
DASPCDF	•	•	•	•	•	•
DASLBDF			•	•	•	•

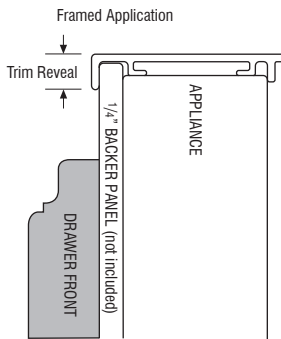

DESCRIPTION

MODEL

PRICE

CUSTOM HINGED DOORS

Custom Doors with Hinge Routing

DOORBL

\$176 /sq ft

DOORBR

\$176 /sq ft

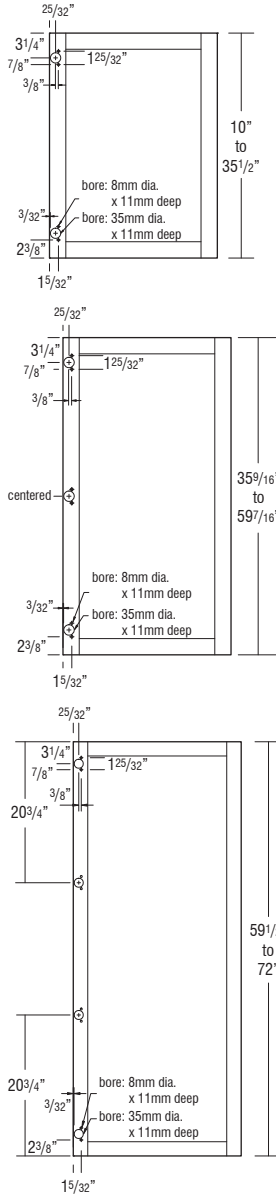

- Plastic mollies pressed in 8mm holes to accept screws to anchor the hinges to the back of these doors.
- Hinges must be ordered separately and specified full or partial overlay.
- Not available in all door styles. See Door Style section for availability.
- Doors are finished on both sides and routed for hinges.
- CG modification available, maximum size is 23 1/2" x 43".
- Custom dimensions are required when placing the order and can be specified in 20/20.
- Not available on MDF door styles. If desired for use with MDF, order as Maple.

Finish Techniques

Heirlooming
•

	Door Style Type	Available Width Range*	Available Height Range
	Non-mitered Styles	7 1/2" to 24" (<3" wide rails/stiles) 8 1/2" to 24" (3" wide rails/stiles)	10" to 47 7/16" (<3" wide rails/stiles) 10" to 47 7/16" (3" wide rails/stiles)
	Non-mitered Styles	7 1/2" to 24" (<3" wide rails/stiles) 8 1/2" to 24" (3" wide rails/stiles)	47 1/2" to 72" (<3" wide rails/stiles) 47 1/2" to 72" (3" wide rails/stiles)
	Mitered Styles	8" to 24"	10" to 61"

*Any door with a minimum width dimension less than 10" will receive a flat center panel.

Custom Doors with Hinge Routing, Slab Styles

DOORSLAB

\$176 /sq ft

- Only available on certain door styles. See Door Style section for availability.
- Doors are finished on both sides and routed for hinges.
- Hinges must be ordered separately and specified full overlay.
- Plastic mollies pressed in 8mm holes to accept screws to anchor the hinges to the back of these doors.
- Custom dimensions are required when placing the order and can be specified in 20/20.

Finish Techniques

Heirlooming

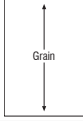
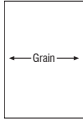
	Door Style Type	Available Width Range	Available Height Range
	Vertical Grain or High Gloss	5" to 24"	10" to 72"
	Horizontal Grain	5" to 24"	10" to 48"

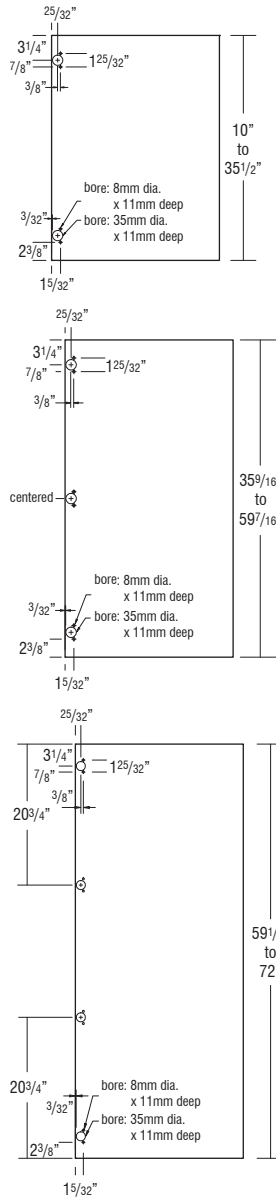

278

TABLE OF CONTENTS – MOULDINGS

- Stack Moulding Kits279
- Crown Mouldings284
- Starter Mouldings287
- Accent Mouldings287
- Toe Mouldings290
- Light Rails291
- Corner Mouldings292
- Window Casing293
- Valances293

DESCRIPTION	MODEL	PRICE
STACK MOULDING KITS		

- Moulding stacks do not ship assembled; field assembly is required. Assembly instructions can be viewed in 20/20 spec pages and will also ship with moulding kits.
- When ordered as a kit, only one finish can be specified. To order with more than one finish, moulding pieces must be ordered separately.
- Moulding stacks include Assembly Instructions. Cleats and finish nails not included.

- How to place a stack moulding in 20/20:
 - Moulding
 - Top Mouldings or Bottom Mouldings
 - Stacked Mouldings
 - Drag and drop desired moulding stack onto wall cabinets
- Mouldings specified as 8' nominal length have a usable length range of 93" up to 99". Mouldings specified as 10' nominal length have a usable length range of 117" up to 123". Be sure to order the correct amount of moulding length to work around required cuts with minimal butt joints.

MOULDING STACK 1

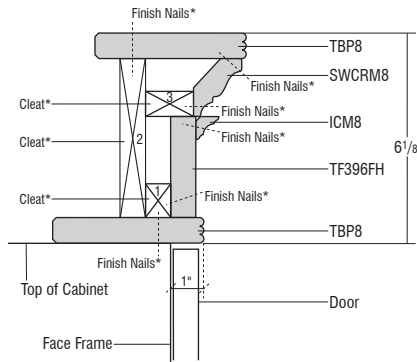
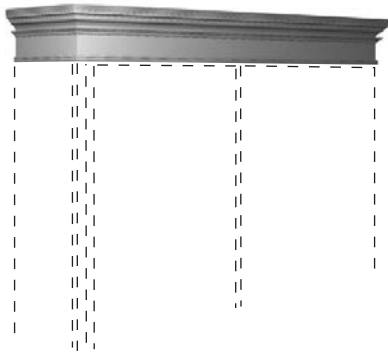

*Cleats and finish nails not included.



STKMLD1

1095

- Not recommended for use when taking application to the ceiling.

Finish Techniques

	Heirlooming
TBP8	•
SWCRM8	•
ICM8	
TF396FH	

Species Availability

	Rustic Alder	Cherry	Rustic Hickory	Laminate	Maple	Oak
TBP8	•		•	box color	•	•
SWCRM8	•	•	•	box color	•	•
ICM8	Alder	•	Hickory	box color	•	•
TF396FH	Alder	•	Hickory	box color	•	•

MOULDING STACK 2

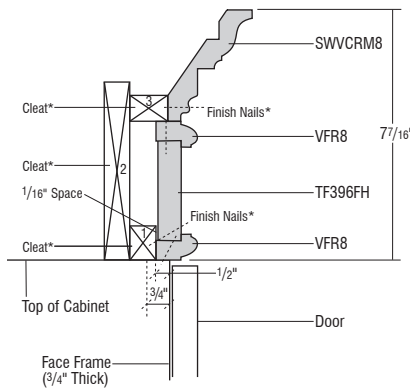
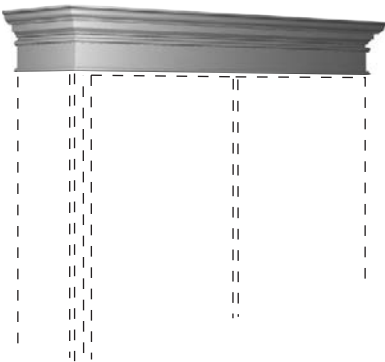

*Cleats and finish nails not included.



STKMLD2

780

- Not recommended for use when taking application to the ceiling.

Finish Techniques

	Heirlooming
SWVCRM8	•
VFR8	•
TF396FH	

Species Availability

	Rustic Alder	Cherry	Rustic Hickory	Laminate	Maple	Oak
SWVCRM8	•	•	•	box color	•	•
VFR8	Alder	•	Hickory	box color	•	•
TF396FH	Alder	•	Hickory	box color	•	•

DESCRIPTION

MODEL

PRICE

MOULDING STACK 3

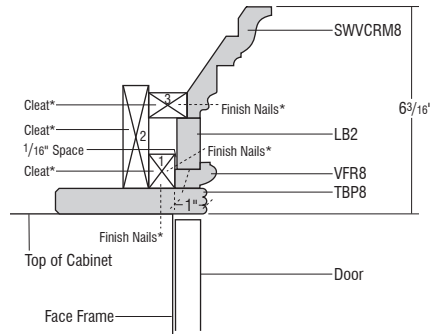
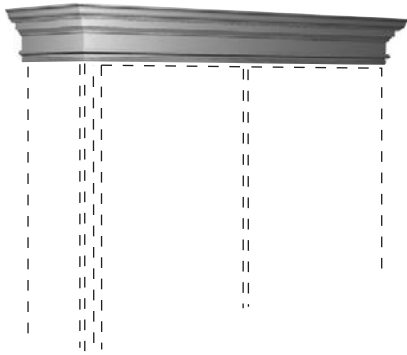

*Cleats and finish nails not included.



STKMLD3

865

- Not recommended for use when taking application to the ceiling.

Finish Techniques

	Heirlooming
SWVCRM8	•
LB2	•
VFR8	•
TBP8	•

Species Availability

	Rustic Alder	Cherry	Rustic Hickory	Laminate	Maple	Oak
SWVCRM8	•	•	•	box color	•	•
LB2	Alder	•	Hickory	box color	•	•
VFR8	Alder	•	Hickory	box color	•	•
TBP8	Alder	•	Hickory	box color	•	•

280

MOULDING STACK 6

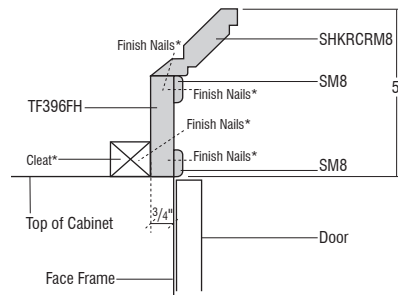
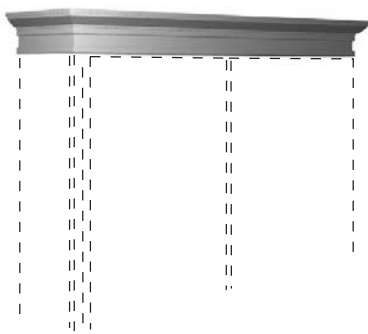

*Cleats and finish nails not included.



STKMLD6

578

- Not recommended for use when taking application to the ceiling.

Finish Techniques

	Heirlooming
SHKRCRM8	•
SM8	•
TF396FH	•

Species Availability

	Rustic Alder	Cherry	Rustic Hickory	Laminate	Maple	Oak
SHKRCRM8	•	•	•	box color	•	•
SM8	Alder	•	Hickory	box color	•	•
TF396FH	Alder	•	Hickory	box color	•	•

MOULDING STACK 10

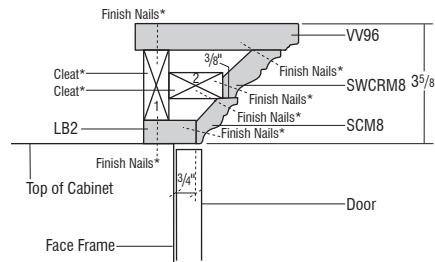
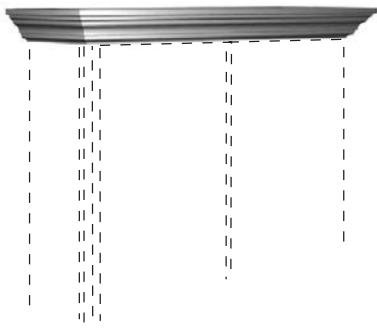

*Cleats and finish nails not included.



STKMLD10

678

- Not recommended for use when taking application to the ceiling.

Finish Techniques

	Heirlooming
VV96	•
SWCRM8	•
SCM8	•
LB2	•

Species Availability

	Rustic Alder	Cherry	Rustic Hickory	Laminate	Maple	Oak
VV96	•	•	•	box color	•	•
SWCRM8	•	•	•	box color	•	•
SCM8	•	•	•	box color	•	•
LB2	Alder	•	Hickory	box color	•	•

MOULDING STACK 11

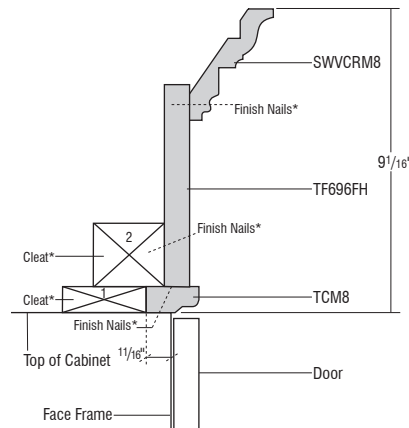
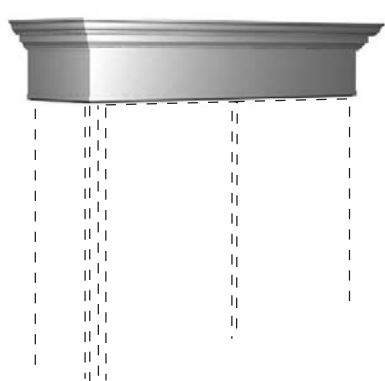

*Cleats and finish nails not included.



STKMLD11

807

Finish Techniques

	Heirlooming
SWVCRM8	•
TF696FH	•
TCM8	•

Species Availability

	Rustic Alder	Cherry	Rustic Hickory	Laminate	Maple	Oak
SWVCRM8	•	•	•	box color	•	•
TF696FH	Alder	•	Hickory	box color	•	•
TCM8	Alder	•	Hickory	box color	•	•

STACK MOULDING KITS

DESCRIPTION

MODEL

PRICE

MOULDING STACK 13

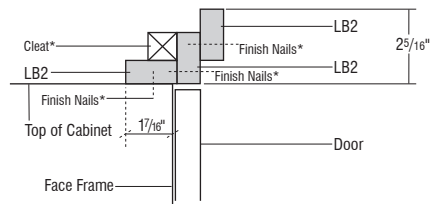
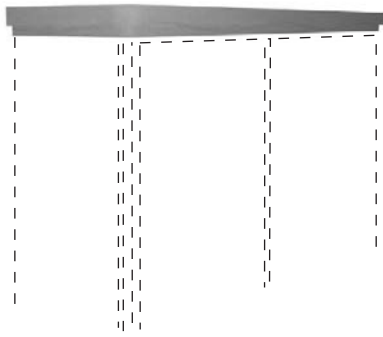

*Cleats and finish nails not included.



STKMLD13

369

Finish Techniques

	Heirlooming
LB2	

Species Availability

	Rustic Alder	Cherry	Rustic Hickory	Laminate	Maple	Oak
LB2	Alder	•	Hickory	box color	•	•

MOULDING STACK 14

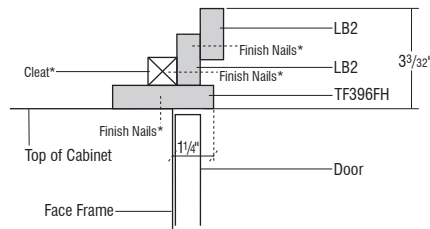
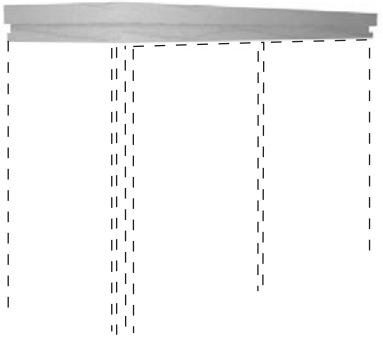

*Cleats and finish nails not included.



STKMLD14

478

Finish Techniques

	Heirlooming
LB2	
TF396FH	

Species Availability

	Rustic Alder	Cherry	Rustic Hickory	Laminate	Maple	Oak
LB2	Alder	•	Hickory	box color	•	•
TF396FH	Alder	•	Hickory	box color	•	•

MOULDING STACK 18

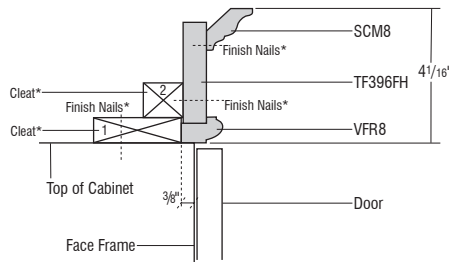
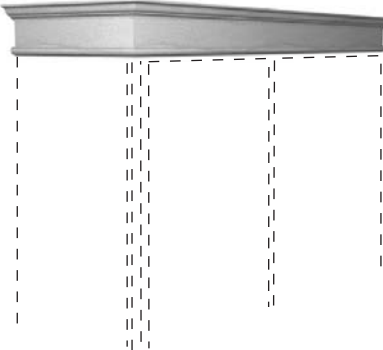

*Cleats and finish nails not included.



STKMLD18

496

Finish Techniques

	Heirlooming
SCM8	•
TF396FH	
VFR8	•

Species Availability

	Rustic Alder	Cherry	Rustic Hickory	Laminate	Maple	Oak
SCM8	•	•	•	box color	•	•
TF396FH	Alder	•	Hickory	box color	•	•
VFR8	Alder	•	Hickory	box color	•	•

MOULDING STACK 20

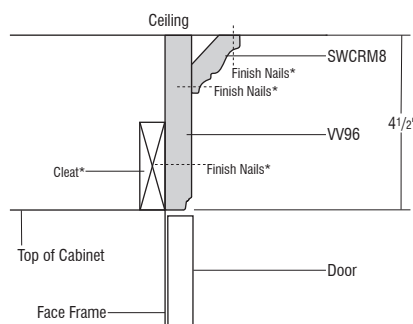
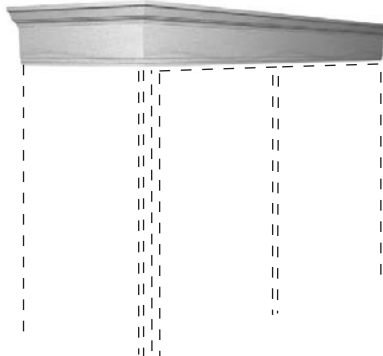

*Cleats and finish nails not included.



STKMLD20

409

Finish Techniques

	Heirlooming
SWCRM8	•
VV96	•

Species Availability

	Rustic Alder	Cherry	Rustic Hickory	Laminate	Maple	Oak
SWCRM8	•	•	•	box color	•	•
VV96	•	•	•	box color	•	•

DESCRIPTION

MODEL

PRICE

MOULDING STACK 21

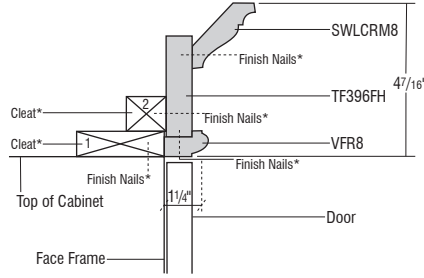
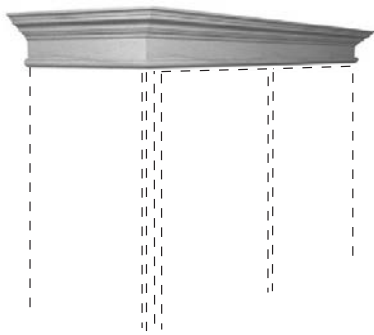

*Cleats and finish nails not included.



STKMLD21

613

Finish Techniques

	Heirlooming
SWLCRM8	•
TF396FH	•
VFR8	•

Species Availability

	Rustic Alder	Cherry	Rustic Hickory	Laminate	Maple	Oak
SWLCRM8	•	•	•	box color	•	•
TF396FH	Alder	•	Hickory	box color	•	•
VFR8	Alder	•	Hickory	box color	•	•

MOULDING STACK 22

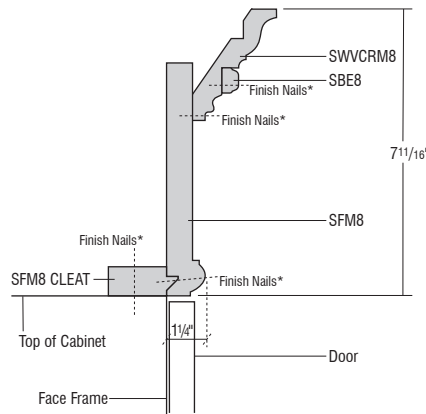
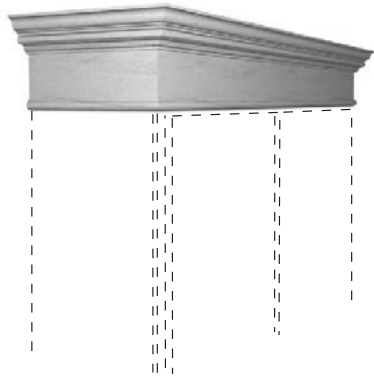

*Cleats and finish nails not included.



STKMLD22

906

Finish Techniques

	Heirlooming
SWVCRM8	•
SBE8	•
SFM8	•

Species Availability

	Rustic Alder	Cherry	Rustic Hickory	Laminate	Maple	Oak
SWVCRM8	•	•	•	box color	•	•
SBE8	Alder	•	Hickory	box color	•	•
SFM8	•	•	•	box color	•	•

MOULDING STACK 23

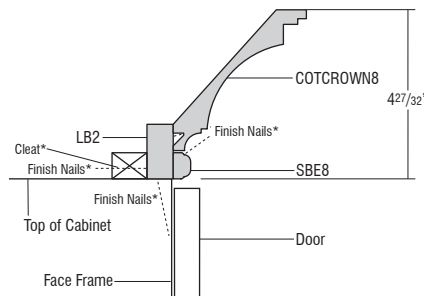

*Cleats and finish nails not included.



STKMLD23

647

- Not recommended for use when taking application to the ceiling.

Finish Techniques

	Heirlooming
COTCROWN8	•
LB2	•
SBE8	•

Species Availability

	Rustic Alder	Cherry	Rustic Hickory	Laminate	Maple	Oak
COTCROWN8	•	•	•	box color	•	•
LB2	Alder	•	Hickory	box color	•	•
SBE8	Alder	•	Hickory	box color	•	•

MOULDING STACK 24

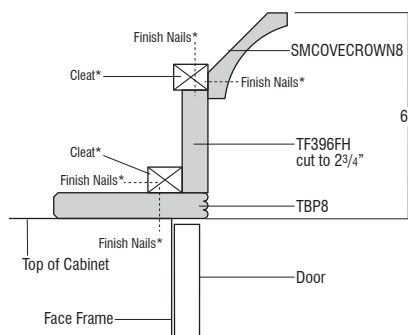

*Cleats and finish nails not included.



STKMLD24

907

- Not recommended for use when taking application to the ceiling.

Finish Techniques

	Heirlooming
SMCOVECROWN8	•
TF396FH	•
TBP8	•

Species Availability

	Rustic Alder	Cherry	Rustic Hickory	Laminate	Maple	Oak
SMCOVECROWN8	•	•	•	box color	•	•
TF396FH	Alder	•	•	box color	•	•
TBP8	Alder	•	•	box color	•	•

DESCRIPTION

MODEL

PRICE

MOULDING STACK 25

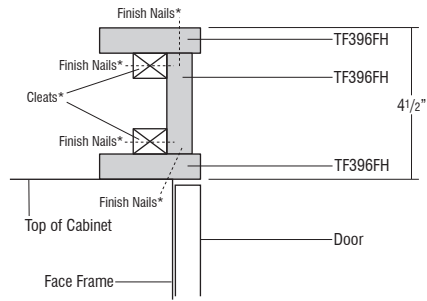
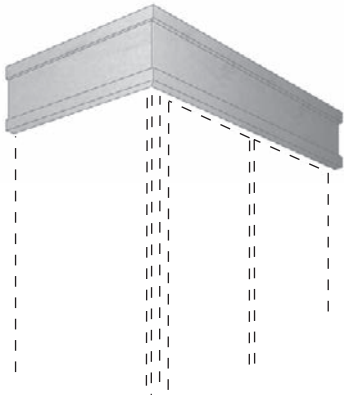

*Cleats and finish nails not included.



STKMLD25

696

- Not recommended for use when taking application to the ceiling.

Finish Techniques

	Heirlooming
TF396FH	

Species Availability

	Rustic Alder	Cherry	Rustic Hickory	Laminate	Maple	Oak
TF396FH	Alder	•	Hickory	box color	•	•

MOULDING STACK 26

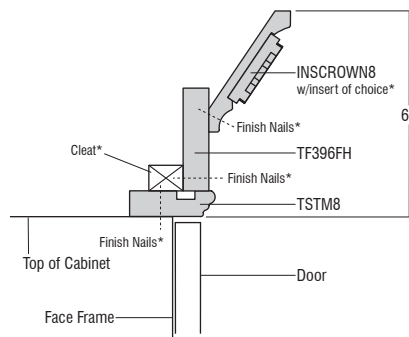
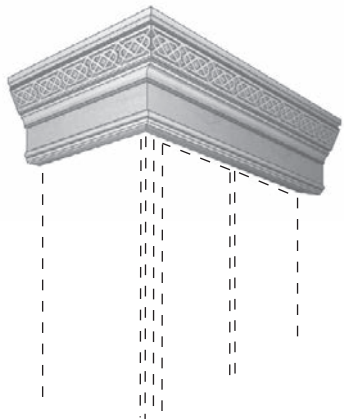

*Price of Insert not included. Insert must be purchased separately. Cleats and finish nails not included.



STKMLD26

900

Finish Techniques

	Heirlooming
INSCROWN8	•
TF396FH	
TSTM8	

Species Availability

	Rustic Alder	Cherry	Rustic Hickory	Laminate	Maple	Oak
INSCROWN8	Alder	•	Hickory	box color	•	•
TF396FH	Alder	•		box color	•	•
TSTM8	Alder	•		box color	•	•

MOULDING STACK 28

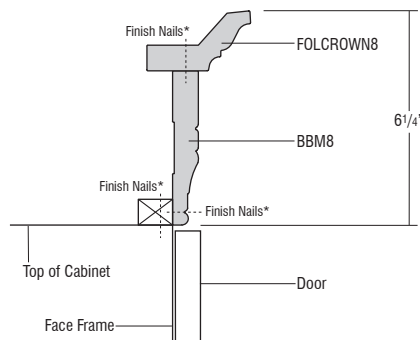

*Cleats and finish nails not included.



STKMLD28

592

- Not recommended for use when taking application to the ceiling.

Finish Techniques

	Heirlooming
FOLCROWN8	•
BBM8	•

Species Availability

	Rustic Alder	Cherry	Rustic Hickory	Laminate	Maple	Oak
FOLCROWN8	•	•	•	box color	•	•
BBM8	•	•	•	box color	•	•



ARCHITECTURAL ACCENTS



All mouldings and embellishments marked with the ☆ follow these guidelines:

Program Details

- Products are priced individually with availability and exceptions noted. Finish technique upcharges apply.
- Items will be shipped loose for field attachment.

Product Characteristics

- Natural characteristics of wood carved items are wider color range, irregularity of surface texture, and more noticeable variations in finish. It is imperative to understand the variations these characteristics entail and therefore will not be considered defective.

Ordering Process

- To ensure product ships with the cabinet order, include on same order. Orders not placed together may not ship together.
- Express Response program is available for 12 day delivery.
- Since these items are ordered on an "as-required" basis, **no changes or cancellations will be accepted after 24 hours from acknowledgment of order.**

MOULDING SPECIFICATIONS

Mouldings specified as 8' nominal length have a usable length range of 93" up to 99". Mouldings specified as 10' nominal length have a usable length range of 117" up to 123". Be sure to order the correct amount of moulding length to work around required cuts with minimal butt joints.

DESCRIPTION	MODEL	PRICE
CROWN MOULDING		

CLASSIC TALL CROWN



CLTCROWN8	402
CLTCROWN10 ☆	543

- CLTCROWN8 is one 8' section.
- CLTCROWN10 is one 10' section. 5 day Express Response not available.
- Cleat shipped unattached, can be used for top mount or face frame applications. For top mount applications on stained finishes, it is not recommended to pull the moulding forward with the cleat visible due to possible color variation with the face frame and moulding.

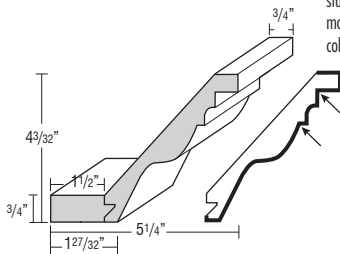

Finish Techniques	
Heirlooming	•

Species Availability

Rustic Alder	Cherry	Rustic Hickory	Laminate	Maple	Oak
•	•	•	box color	•	•

☆ Only available in Cherry and Maple.

CORNICE TALL CROWN



COTCROWN8	402
COTCROWN10 ☆	543

- COTCROWN8 is one 8' section.
- COTCROWN10 is one 10' section. 5 day Express Response not available.
- Cleat shipped unattached, can be used for top mount or face frame applications. For top mount applications on stained finishes, it is not recommended to pull the moulding forward with the cleat visible due to possible color variation with the face frame and moulding.

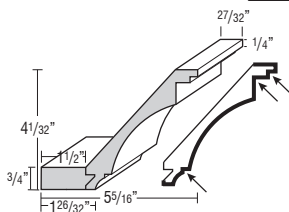

Finish Techniques	
Heirlooming	•

Species Availability

Rustic Alder	Cherry	Rustic Hickory	Laminate	Maple	Oak
•	•	•	box color	•	•

☆ Only available in Cherry and Maple.

DESCRIPTION

MODEL

PRICE

COVE CROWN



COVECROWN8	402
COVECROWN10 ☆	543

- COVECROWN8 is one 8' section.
- COVECROWN10 is one 10' section. 5 day Express Response not available.
- Cleat shipped unattached, can be used for top mount or face frame applications. For top mount applications on stained finishes, it is not recommended to pull the moulding forward with the cleat visible due to possible color variation with the face frame and moulding.

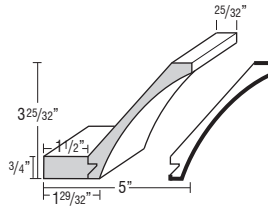

Finish Techniques

Heirlooming	•
-------------	---

Species Availability

Rustic Alder	Cherry	Rustic Hickory	Laminate	Maple	Oak
•	•	•	box color	•	•

☆ Only available in Cherry and Maple.

FULL OVERLAY CROWN



FOLCROWN8	319
-----------	-----

- One 8' section.
- Attached cleat for top-mount application.

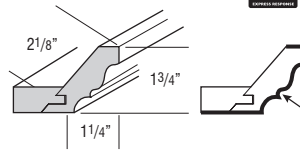

Finish Techniques

Heirlooming	•
-------------	---

Species Availability

Rustic Alder	Cherry	Rustic Hickory	Laminate	Maple	Oak
•	•	•	box color	•	•

INSERT CROWN



INSCROWN8	448
-----------	-----

- One 8' section.
- Designed for use with all 2 1/4" insert mouldings.

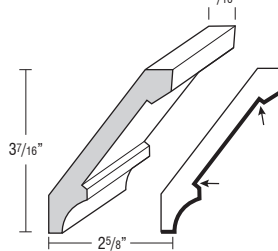

Finish Techniques

Heirlooming	•
-------------	---

Species Availability

Rustic Alder	Cherry	Rustic Hickory	Laminate	Maple	Oak
•	•	•	box color	•	•

LARGE STRAIGHT ANGLE CROWN



LSACROWN8	312
LSACROWN10 ☆	422

- LSACROWN8 is one 8' section.
- LSACROWN10 is one 10' section. 5 day Express Response not available.
- Cleat shipped unattached, can be used for top mount or face frame applications. For top mount applications on stained finishes, it is not recommended to pull the moulding forward with the cleat visible due to possible color variation with the face frame and moulding.

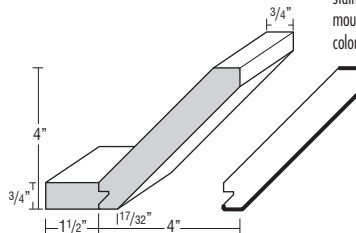

Finish Techniques

Heirlooming	•
-------------	---

Species Availability

Rustic Alder	Cherry	Rustic Hickory	Laminate	Maple	Oak
•	•	•	box color	•	•

☆ Only available in Cherry and Maple.

Finished edges indicated by bold lines on side view drawings.
Glazed edges indicated by arrows on side view drawings.

DESCRIPTION

MODEL

PRICE

MEDIUM STRAIGHT ANGLE CROWN



MSACROWN8 282
MSACROWN10 ♦ 380

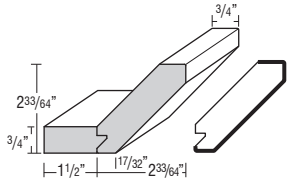

- MSACROWN8 is one 8' section.
- MSACROWN10 is one 10' section. 5 day Express Response not available.
- Cleat shipped unattached, can be used for top mount or face frame applications. For top mount applications on stained finishes, it is not recommended to pull the moulding forward with the cleat visible due to possible color variation with the face frame and moulding.

Finish Techniques

Heirlooming
•

Species Availability

Rustic Alder	Cherry	Rustic Hickory	Laminate	Maple	Oak
•	•	•	box color	•	•

♦ Only available in Cherry and Maple.

STRAIGHT ANGLE CROWN



SACROWN8 263
SACROWN10 ♦ 355

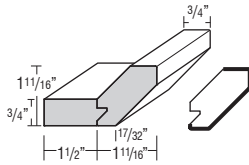

- SACROWN8 is one 8' section.
- SACROWN10 is one 10' section. 5 day Express Response not available.
- Cleat shipped unattached, can be used for top mount or face frame applications. For top mount applications on stained finishes, it is not recommended to pull the moulding forward with the cleat visible due to possible color variation with the face frame and moulding.

Finish Techniques

Heirlooming
•

Species Availability

Rustic Alder	Cherry	Rustic Hickory	Laminate	Maple	Oak
•	•	•	box color	•	•

♦ Only available in Cherry and Maple.

TALL CROWN



MTCROWN8 282
MTCROWN10 ♦ 380

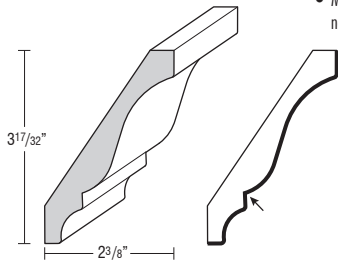

- MTCROWN8 is one 8' section.
- MTCROWN10 is one 10' section. 5 day Express Response not available.

Finish Techniques

Heirlooming
•

Species Availability

Rustic Alder	Cherry	Rustic Hickory	Laminate	Maple	Oak
•	•	•	box color	•	•

♦ Only available in Cherry and Maple.

SHAKER CROWN



SHKRCRM8 204

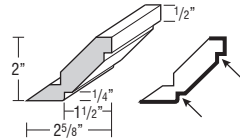

- Top mount moulding.
- One 8' section.

Finish Techniques

Heirlooming
•

Species Availability

Rustic Alder	Cherry	Rustic Hickory	Laminate	Maple	Oak
•	•	•	box color	•	•

DESCRIPTION

MODEL

PRICE

LARGE SHAKER CROWN



LSHAKER8 204
LSHAKER10 ♦ 273

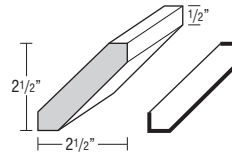

- LSHAKER8 is one 8' section.
- LSHAKER10 is one 10' section. 5 day Express Response not available.

Finish Techniques

Heirlooming
•

Species Availability

Rustic Alder	Cherry	Rustic Hickory	Laminate	Maple	Oak
•	•	•	box color	•	•

♦ Only available in Cherry and Maple.

LARGE SHAKER CROWN, PREMIUM



LSHAKER8P 612
LSHAKER10P 825

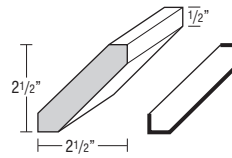

- LSHAKER8P is one 8' section.
- LSHAKER10P is one 10' section. 5 day Express Response not available.
- Horizontal grain.

Finish Techniques

Heirlooming
•

Species Availability

Rustic Alder	Cherry	Rustic Hickory	Laminate	Maple	Oak
			• ¹		

¹LSHAKER10P not available in certain finishes. See Finish Availability section for exceptions.

SMALL COVE CROWN MOULDING



SMCOVECROWN8 363
SMCOVECROWN10 ♦ 491

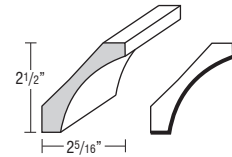

- SMCOVECROWN8 is one 8' section.
- SMCOVECROWN10 is one 10' section. 5 day Express Response not available.

Finish Techniques

Heirlooming
•

Species Availability

Rustic Alder	Cherry	Rustic Hickory	Laminate	Maple	Oak
•	•		box color	•	•

♦ Only available in Cherry and Maple.

Finished edges indicated by bold lines on side view drawings.
 Glazed edges indicated by arrows on side view drawings.

DESCRIPTION MODEL PRICE

SMALL CROWN	 SCM8	146
	SCM10 ♦	196

- Face mounts on Partial Overlay doors. May be face mounted on Full Overlay if used with a cleat.
- SCM8 is one 8" section.
- SCM10 is one 10" section. 5 day Express Response not available.
- Moulding can be used as standard or inverted.

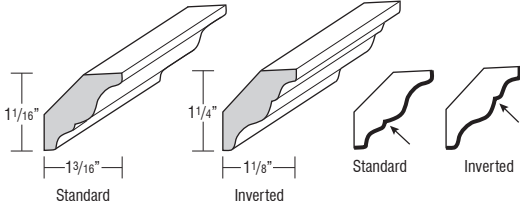

Finish Techniques

Heirlooming
•

Species Availability

Rustic Alder	Cherry	Rustic Hickory	Laminate	Maple	Oak
•	•	•	box color	•	•

♦ Only available in Cherry and Maple.

SOLID-WOOD CROWN	 SWCRM8	156
	SWCRM10 ♦	209

- Face mounts on Partial Overlay doors. May be face mounted on Full Overlay if used with a cleat.
- SWCRM8 is one 8" section.
- SWCRM10 is one 10" section. 5 day Express Response not available.
- Moulding can be used as standard or inverted.

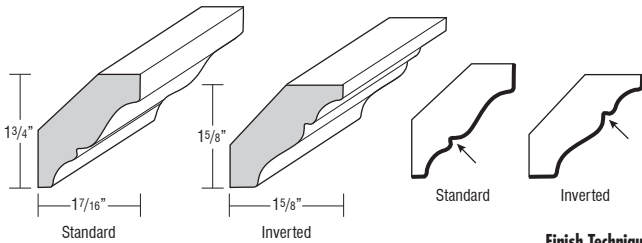

Finish Techniques

Heirlooming
•

Species Availability

Rustic Alder	Cherry	Rustic Hickory	Laminate	Maple	Oak
•	•	•	box color	•	•

♦ Only available in Cherry and Maple.

DESCRIPTION MODEL PRICE

SOLID-WOOD LARGE CROWN	 SWLCRM8	263
	SWLCRM10 ♦	355

- Face mounts on Partial Overlay doors. May be face mounted on Full Overlay if used with a cleat.
- SWLCRM8 is one 8" section.
- SWLCRM10 is one 10" section. 5 day Express Response not available.
- Moulding can be used as standard or inverted.

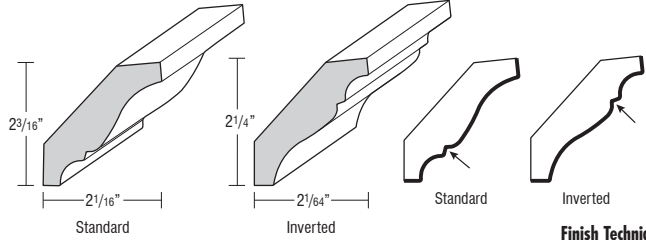

Finish Techniques

Heirlooming
•

Species Availability

Rustic Alder	Cherry	Rustic Hickory	Laminate	Maple	Oak
•	•	•	box color	•	•

♦ Only available in Cherry and Maple.

SOLID-WOOD TALL CROWN	 SWTCRM8	282
	SWTCRM10 ♦	380

- Face mounts on Partial Overlay doors. May be face mounted on Full Overlay if used with a cleat.
- SWTCRM8 is one 8" section.
- SWTCRM10 is one 10" section. 5 day Express Response not available.
- Moulding can be used as standard or inverted.

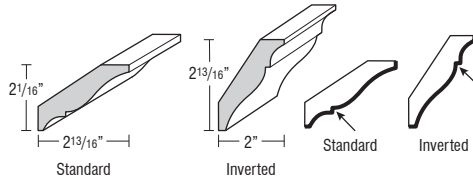

Finish Techniques

Heirlooming
•

Species Availability

Rustic Alder	Cherry	Rustic Hickory	Laminate	Maple	Oak
•	•	•	box color	•	•

♦ Only available in Cherry and Maple.

SOLID-WOOD VICTORIAN CROWN	 SWVCRM8	312
	SWVCRM10 ♦	422

- Face mounts on Partial Overlay doors. May be face mounted on Full Overlay if used with a cleat.
- SWVCRM8 is one 8" section.
- SWVCRM10 is one 10" section. 5 day Express Response not available.

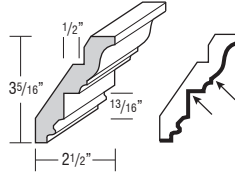

Finish Techniques

Heirlooming
•

Species Availability

Rustic Alder	Cherry	Rustic Hickory	Laminate	Maple	Oak
•	•	•	box color	•	•

♦ Only available in Cherry and Maple.

Finished edges indicated by bold lines on side view drawings.
Glazed edges indicated by arrows on side view drawings.

DESCRIPTION MODEL PRICE
STARTER MOULDINGS

SOFFIT FILLER MOULDING

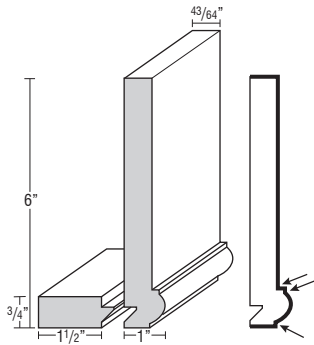

SFM8 472
SFM10 ♦ 636

- SFM8 is one 8' section.
- SFM10 is one 10' section. 5 day Express Response not available.
- Clear shipped unattached, can be used for top mount or face frame applications. For top mount applications on stained finishes, it is not recommended to pull the moulding forward with the cleat visible due to possible color variation with the face frame and moulding.
- Use SFM8 and face mount crown when stacking mouldings to ceiling and ceiling height is uneven.

Finish Techniques

Heirlooming
•

Species Availability

Rustic Alder	Cherry	Rustic Hickory	Laminate	Maple	Oak
•	•	•	box color	•	•

♦ Only available in Cherry and Maple.

STARTER MOULDING

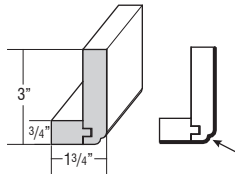

STR8 482
STR10 ♦ 651

- STR8 is one 8' section.
- STR10 is one 10' section. 5 day Express Response not available.
- Attached cleat for top-mount application.

Finish Techniques

Heirlooming
•

Species Availability

Rustic Alder	Cherry	Rustic Hickory	Laminate	Maple	Oak
•	•	•	box color	•	•

♦ Only available in Cherry and Maple.

STARTER MOULDING, SHAKER

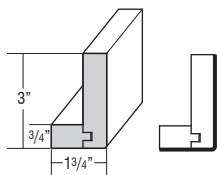

STRS8 419
STRS10 ♦ 552

- STRS8 is one 8' section.
- STRS10 is one 10' section. 5 day Express Response not available.
- Attached cleat for top-mount application.

Finish Techniques

Heirlooming
•

Species Availability

Rustic Alder	Cherry	Rustic Hickory	Laminate	Maple	Oak
•	•	•	box color	•	•

♦ Only available in Cherry and Maple.

STARTER MOULDING, SHAKER PREMIUM

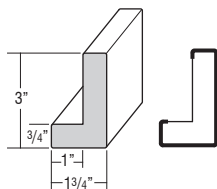

STRS8P 1047

- One 8' section.
- Horizontal grain.

Finish Techniques

Heirlooming
•

Species Availability

Rustic Alder	Cherry	Rustic Hickory	Laminate	Maple	Oak
			•		

DESCRIPTION MODEL PRICE
ACCENT MOULDING

BACK PANEL MOULDING

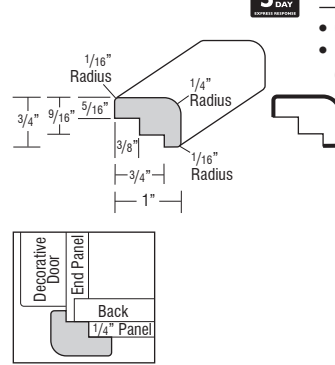

BPM8 130

- One 8' section.
- Designed to provide a decorative edge between cabinet and panel-corner seam.

Finish Techniques

Heirlooming
•

Species Availability

Rustic Alder	Cherry	Rustic Hickory	Laminate	Maple	Oak
•	•	•	box color	•	•

CABINET PANEL EDGE

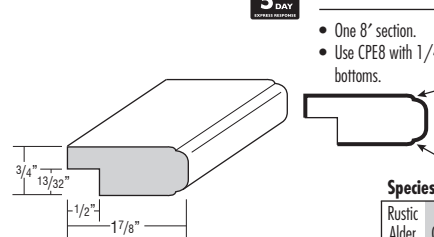

CPE8 186

- One 8' section.
- Use CPE8 with 1/4" wood skin to create flush cabinet bottoms.

Finish Techniques

Heirlooming
•

Species Availability

Rustic Alder	Cherry	Rustic Hickory	Laminate	Maple	Oak
•	•	•	box color	•	•

COUNTERTOP EDGE

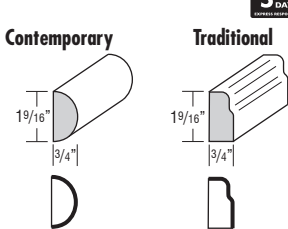

CCM8 99

TCM8 99

- One 8' section.

Finish Techniques

Heirlooming
•

¹Available on TCM8 only

Species Availability

Rustic Alder	Cherry	Rustic Hickory	Laminate	Maple	Oak
•	•	•	box color	•	•

BATTEN

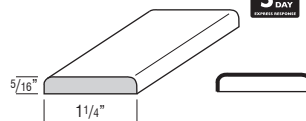

BATTEN8 85

- One 8' section.

Finish Techniques

Heirlooming
•

Species Availability

Rustic Alder	Cherry	Rustic Hickory	Laminate	Maple	Oak
•	•	•	box color	•	•

Finished edges indicated by bold lines on side view drawings.
 Glazed edges indicated by arrows on side view drawings.

DESCRIPTION MODEL PRICE

FLAT SCRIBE



SM8 71
SM10 ♦ 95

- SM8 is one 8' section.
- SM10 is one 10' section. 5 day Express Response not available.

Finish Techniques

Heirlooming

Species Availability

Rustic Alder	Cherry	Rustic Hickory	Laminate	Maple	Oak
•	•	•	•	•	•

♦ Only available in Cherry and Maple.

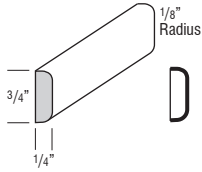

FLAT SCRIBE, PREMIUM



SM8P 183
SM10P 246

- SM8P is one 8' section.
- SM10P is one 10' section. 5 day Express Response not available.
- Horizontal grain.

Finish Techniques

Heirlooming

Species Availability

Rustic Alder	Cherry	Rustic Hickory	Laminate	Maple	Oak
•	•	•	•	•	•

† SM10P not available in certain finishes. See Finish Availability section for exceptions.

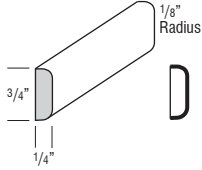

LIBRARY MOULDING



LBRM 343

- One 8' section.
- Use Library Moulding as a part of a moulding stack or vertically to cover seams in a row of bookcases.

Finish Techniques

Heirlooming

Species Availability

Rustic Alder	Cherry	Rustic Hickory	Laminate	Maple	Oak
•	•	•	box color	•	•

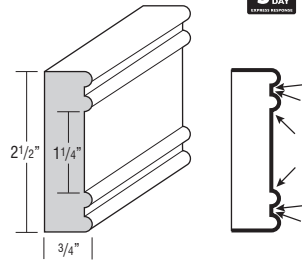

MIRROR FRAME



WMF8 143

- Pre-grooved.
- One 8' section.

Finish Techniques

Heirlooming

Species Availability

Rustic Alder	Cherry	Rustic Hickory	Laminate	Maple	Oak
•	•	•	box color	•	•

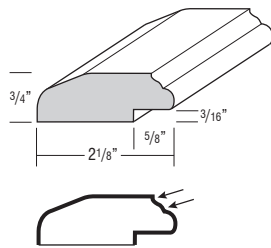

DESCRIPTION MODEL PRICE

OGEE EDGE



OGEEEM 122

- One 8' section.

Finish Techniques

Heirlooming

Species Availability

Rustic Alder	Cherry	Rustic Hickory	Laminate	Maple	Oak
•	•	•	box color	•	•

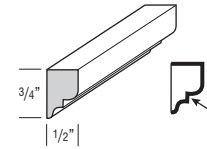

SINGLE BEAD EDGE



SBE8 122

- One 8' section.

Finish Techniques

Heirlooming

Species Availability

Rustic Alder	Cherry	Rustic Hickory	Laminate	Maple	Oak
•	•	•	box color	•	•

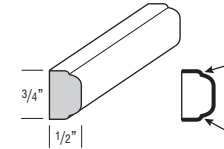

SINGLE BEAD MOULDING



SBM8 312

- One 8' section.

Finish Techniques

Heirlooming

Species Availability

Rustic Alder	Cherry	Rustic Hickory	Laminate	Maple	Oak
•	•	•	box color	•	•

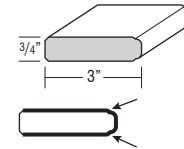

SINGLE BEAD PILASTER



SBP8 306

- One 8' section.
- Can be used vertically between cabinets for an inset look.

Finish Techniques

Heirlooming

Species Availability

Rustic Alder	Cherry	Rustic Hickory	Laminate	Maple	Oak
•	•	•	box color	•	•

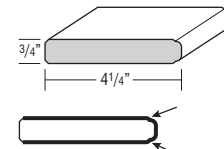

SMALL SCRIBE



SCRIBE8 60
SCRIBE10 ♦ 83

- SCRIBE8 is one 8' section.
- SCRIBE10 is one 10' section. 5 day Express Response not available.

Finish Techniques

Heirlooming

Species Availability

Rustic Alder	Cherry	Rustic Hickory	Laminate	Maple	Oak
•	•	•	box color	•	•

♦ Only available in Cherry and Maple.

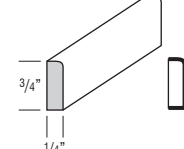

Finished edges indicated by bold lines on side view drawings.
 Glazed edges indicated by arrows on side view drawings.

DESCRIPTION

MODEL

PRICE

SMALL SCRIBE, PREMIUM



SSM8P

183

SSM10P

246

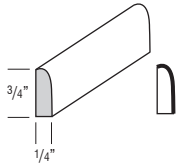

- SSM8P is one 8" section.
- SSM10P is one 10" section. 5 day Express Response not available.
- Horizontal grain.

Finish Techniques

Heirlooming

Species Availability

Rustic Alder	Cherry	Rustic Hickory	Laminate	Maple	Oak
			•		

¹SSM10P not available in certain finishes. See Finish Availability section for exceptions.

SOFFIT TRIM MOULDING



TSTM8

220

TSTM10 ♦

298

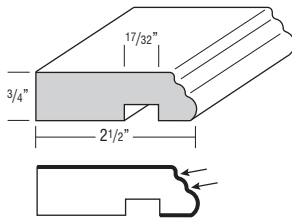

- TSTM8 is one 8" section.
- TSTM10 is one 10" section. 5 day Express Response not available.

Finish Techniques

Heirlooming

Species Availability

Rustic Alder	Cherry	Rustic Hickory	Laminate	Maple	Oak
	•	Hickory	box color	•	•

♦ Only available in Cherry and Maple.

TRIPLE BEAD EDGE



TBEM

128

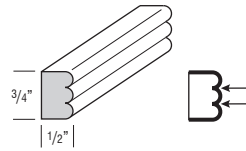

- One 8" section.

Finish Techniques

Heirlooming
•

Species Availability

Rustic Alder	Cherry	Rustic Hickory	Laminate	Maple	Oak
	•	Hickory	box color	•	•

TRIPLE BEAD PILASTER



TBP8

312

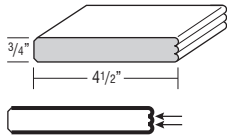

- Finished beaded front and two 4 1/2" sides.
- Can be used vertically between cabinets for an inset look.
- One 8" section.

Finish Techniques

Heirlooming
•

Species Availability

Rustic Alder	Cherry	Rustic Hickory	Laminate	Maple	Oak
	•	Hickory	box color	•	•

DESCRIPTION

MODEL

PRICE

WIDE SCRIBE



WSCRIBE

223

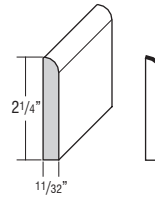

- One 8" section.

Finish Techniques

Heirlooming
•

Species Availability

Rustic Alder	Cherry	Rustic Hickory	Laminate	Maple	Oak
	•	Hickory	box color	•	•

UNDER PANEL MOULDING



UPM8

164

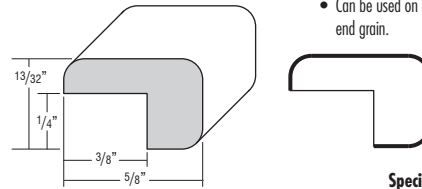

- One 8" section.
- Can be used on edges of 1/4" thick panels to conceal end grain.

Finish Techniques

Heirlooming

Species Availability

Rustic Alder	Cherry	Rustic Hickory	Laminate	Maple	Oak
	•	Hickory	box color	•	

UNDER PANEL MOULDING, PREMIUM



UPM8P

409

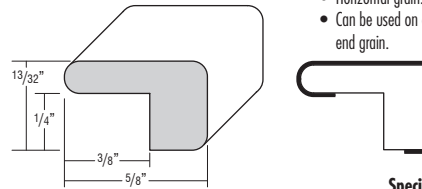

- Not available with high gloss doors.
- One 8" section.
- Horizontal grain.
- Can be used on edges of 1/4" thick panels to conceal end grain.

Finish Techniques

Heirlooming

Species Availability

Rustic Alder	Cherry	Rustic Hickory	Laminate	Maple	Oak
			•		

Finished edges indicated by bold lines on side view drawings.
Glazed edges indicated by arrows on side view drawings.

DESCRIPTION **MODEL** **PRICE**
TOE MOULDING

BASEBOARD

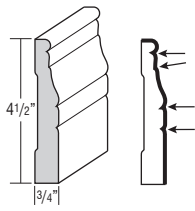

BBM8 273
BBM10 ♦ 371

- BBM8 is one 8" section.
- BBM10 is one 10" section. 5 day Express Response not available.
- BBM8 can be used in place of standard toekick to provide a surface for glaze hang-up on premium finishes.

Finish Techniques

Heirlooming
•

Species Availability

Rustic Alder	Cherry	Rustic Hickory	Laminate	Maple	Oak
•	•	•	box color	•	•

♦ Only available in Cherry and Maple.

BASEBOARD - FURNITURE

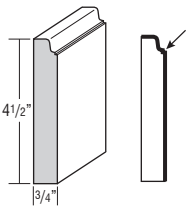

BBMF8 273
 • One 8" section.

Finish Techniques

Heirlooming
•

Species Availability

Rustic Alder	Cherry	Rustic Hickory	Laminate	Maple	Oak
Alder	•	Hickory	box color	•	•

BASEBOARD - SCULPTED

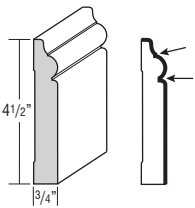

BBMSC 296
 • One 8" section.
 • BBMSC can be used in place of standard toekick to provide a surface for glaze hang-up on premium finishes.

Finish Techniques

Heirlooming
•

Species Availability

Rustic Alder	Cherry	Rustic Hickory	Laminate	Maple	Oak
•	•	•	box color	•	•

BASEBOARD - SHAKER

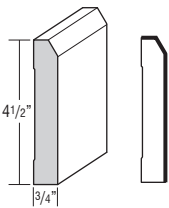

BBMSH8 296
BBMSH10 ♦ 390
 • BBMSH8 is one 8" section.
 • BBMSH10 is one 10" section. 5 day Express Response not available.

Finish Techniques

Heirlooming
•

Species Availability

Rustic Alder	Cherry	Rustic Hickory	Laminate	Maple	Oak
•	•	•	box color	•	•

♦ Only available in Cherry and Maple.

BASEBOARD - SWOOPED

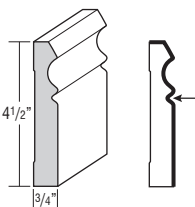

BBMSW 296
 • One 8" section.
 • BBMSW can be used in place of standard toekick to provide a surface for glaze hang-up on premium finishes.

Finish Techniques

Heirlooming
•

Species Availability

Rustic Alder	Cherry	Rustic Hickory	Laminate	Maple	Oak
•	•	•	box color	•	•

DESCRIPTION **MODEL** **PRICE**

TOEBOARDS



TB8LAM14 ♦ 61
TB8WD14 121

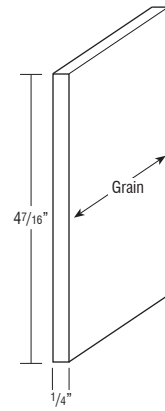

- TB8LAM14 is 1/4" laminated furniture board (White only).
- TB8WD14 in Stains: 1/4" thick veneered furniture board.
- TB8WD14 in Paints: 1/4" thick veneered or solid furniture board.
- One 8" section.
- Remember to order Toekick Cap for each exposed end of toeboard.

Finish Techniques

Heirlooming
•

Species Availability

Rustic Alder	Cherry	Rustic Hickory	Laminate	Maple	Oak
Alder	•	Hickory	box color	•	•

♦ Only available in White Laminate.

TOEBOARDS, PREMIUM



TB8P14 243

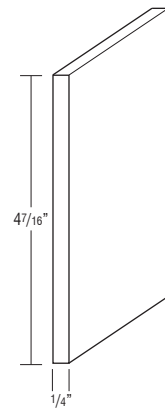

- 1/4" thick laminated MDF.
- One 8" section.
- Horizontal grain.

Finish Techniques

Heirlooming
•

Species Availability

Rustic Alder	Cherry	Rustic Hickory	Laminate	Maple	Oak
Alder	•	Hickory	•	•	•

TOEKICK CAP



TKC 34 /pair

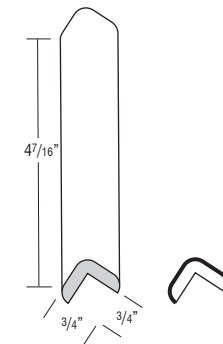

- Sold in pairs.

Finish Techniques

Heirlooming
•

Species Availability

Rustic Alder	Cherry	Rustic Hickory	Laminate	Maple	Oak
Maple	Maple	Oak	box color	•	•

Finished edges indicated by bold lines on side view drawings.
 Glazed edges indicated by arrows on side view drawings.

DESCRIPTION

MODEL

PRICE

LIGHT RAILS

CAP MOULDING



CAPM

144

- One 8' section.

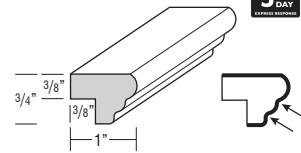

Finish Techniques

Heirlooming
•

Species Availability

Rustic Alder	Cherry	Rustic Hickory	Laminate	Maple	Oak
Alder	•	Hickory	box color	•	•

CABINET PANEL EDGE SQUARE



CPES

140

- One 8' section.
- Standard application must be shimmed at the notch or used with an under-cabinet skin if used with full overlay styles. Inverted application does not require a shim or panel.
- Standard application can be used as a top-mount moulding.

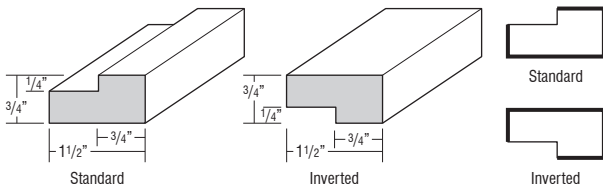

Finish Techniques

Heirlooming
•

Species Availability

Rustic Alder	Cherry	Rustic Hickory	Laminate	Maple	Oak
Alder	•	Hickory	box color	•	•

FURNITURE BASE LIGHT RAIL



FBLR8

144

- One 8' section.

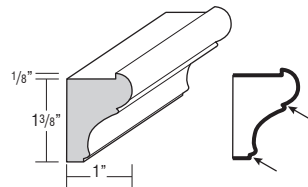

Finish Techniques

Heirlooming
•

Species Availability

Rustic Alder	Cherry	Rustic Hickory	Laminate	Maple	Oak
Alder	•	Hickory	box color	•	•

LIGHT BAFFLE



LB2

123

- One 8' section.

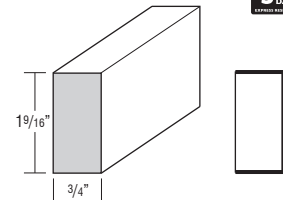

Finish Techniques

Heirlooming
•

Species Availability

Rustic Alder	Cherry	Rustic Hickory	Laminate	Maple	Oak
Alder	•	Hickory	box color	•	•

DESCRIPTION

MODEL

PRICE

LIGHT BAFFLE, PREMIUM



LB2P

370

- One 8' section.
- Horizontal grain.

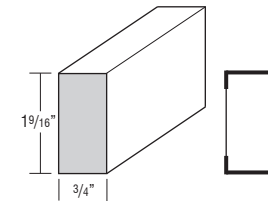

Finish Techniques

Heirlooming
•

Species Availability

Rustic Alder	Cherry	Rustic Hickory	Laminate	Maple	Oak
Alder	•	Hickory	box color	•	•

LIGHT RAIL CAP



SOFFITA

118

- One 8' section.
- Must be shimmed at the notch or used with an under-cabinet skin if used with full overlay styles.

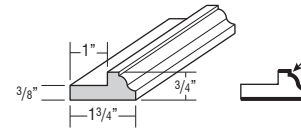

Finish Techniques

Heirlooming
•

Species Availability

Rustic Alder	Cherry	Rustic Hickory	Laminate	Maple	Oak
Alder	•	Hickory	box color	•	•

LIGHT RAIL CAP - SHAKER



SOFFITE

118

- One 8' section.
- Must be shimmed at the notch or used with an under-cabinet skin if used with full overlay styles.

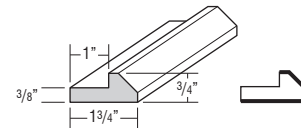

Finish Techniques

Heirlooming
•

Species Availability

Rustic Alder	Cherry	Rustic Hickory	Laminate	Maple	Oak
Alder	•	Hickory	box color	•	•

SMALL LIGHT RAIL MOULDING



SMLR

451

- One 8' section.

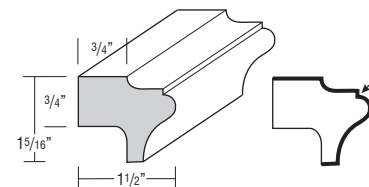

Finish Techniques

Heirlooming
•

Species Availability

Rustic Alder	Cherry	Rustic Hickory	Laminate	Maple	Oak
Alder	•	Hickory	box color	•	•

LIGHT RAIL MOULDING



LRM

517

- One 8' section.

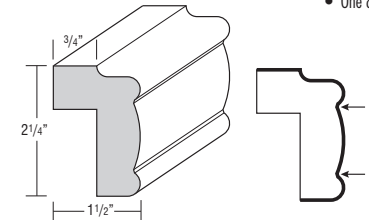

Finish Techniques

Heirlooming
•

Species Availability

Rustic Alder	Cherry	Rustic Hickory	Laminate	Maple	Oak
Alder	•	Hickory	box color	•	•

Finished edges indicated by bold lines on side view drawings.
Glazed edges indicated by arrows on side view drawings.

DESCRIPTION MODEL PRICE

VALLEY FORGE



VFR8

118

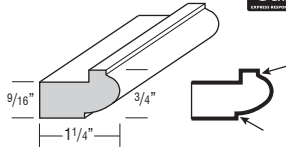

- One 8' section.
- Must be shimmed at the notch or used with an under-cabinet skin if used with full overlay styles.

Finish Techniques

Heirlooming
•

Species Availability

Rustic Alder	Cherry	Rustic Hickory	Laminate	Maple	Oak
	•	Hickory	box color	•	•

TRADITIONAL LIGHT RAIL



JINSERTLRT

769

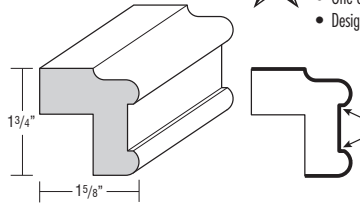

- One 8' section.
- Designed for use with all 3/4" insert mouldings.

Finish Techniques

Heirlooming
•

Species Availability

Rustic Alder	Cherry	Rustic Hickory	Laminate	Maple	Oak
	•	Hickory	box color	•	•

CONTEMPORARY LIGHT RAIL



JINSERTLRC

740

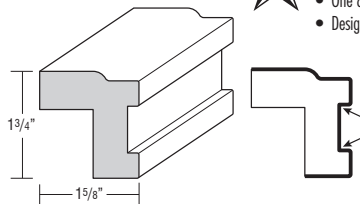

- One 8' section.
- Designed for use with all 3/4" insert mouldings.

Finish Techniques

Heirlooming
•

Species Availability

Rustic Alder	Cherry	Rustic Hickory	Laminate	Maple	Oak
	•	Hickory	box color	•	•

CORNER MOULDINGS

DIAGONAL CORNER



DCM8

190

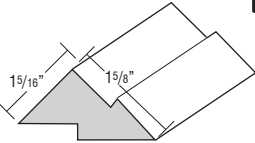

- Designed to set cabinets at a 45° corner application using 3/4" end panels.
- One 8' section.
- Not compatible on cabinets with Furniture Ends (FPEB) or Authentic Ends (AUTHL/AUTHR/AUTHB).

Finish Techniques

Heirlooming
•

Species Availability

Rustic Alder	Cherry	Rustic Hickory	Laminate	Maple	Oak
	•	Hickory	box color	•	•

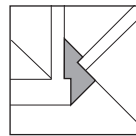
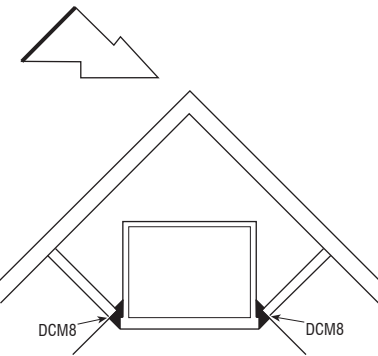

DESCRIPTION MODEL PRICE

INSIDE CORNER



ICM8

83

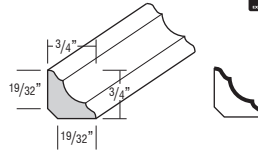

- One 8' section.

Finish Techniques

Heirlooming
•

Species Availability

Rustic Alder	Cherry	Rustic Hickory	Laminate	Maple	Oak
	•	Hickory	box color	•	•

INSIDE CORNER, PREMIUM



ICM8P

249

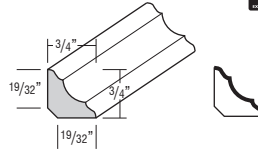

- One 8' section.
- Horizontal grain.

Finish Techniques

Heirlooming
•

Species Availability

Rustic Alder	Cherry	Rustic Hickory	Laminate	Maple	Oak
		Hickory	•		

LARGE OUTSIDE CORNER



LOSC8

128

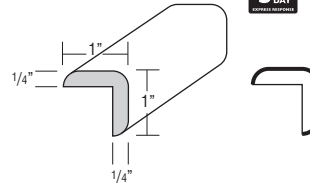

- One 8' section.

Finish Techniques

Heirlooming
•

Species Availability

Rustic Alder	Cherry	Rustic Hickory	Laminate	Maple	Oak
	•	Hickory	box color	•	•

OUTSIDE CORNER



OCM8

76

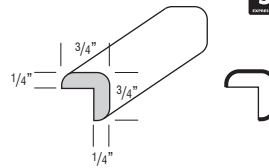

- One 8' section.

Finish Techniques

Heirlooming
•

Species Availability

Rustic Alder	Cherry	Rustic Hickory	Laminate	Maple	Oak
	•	Hickory	box color	•	•

OUTSIDE CORNER, PREMIUM



OCM8P

227

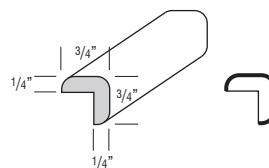

- One 8' section.
- Horizontal grain.

Finish Techniques

Heirlooming
•

Species Availability

Rustic Alder	Cherry	Rustic Hickory	Laminate	Maple	Oak
		Hickory	•		

Finished edges indicated by bold lines on side view drawings.
Glazed edges indicated by arrows on side view drawings.

DESCRIPTION MODEL PRICE

OUTSIDE CORNER 135°



OC135

122

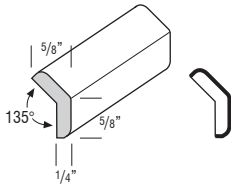

- One 8' section.

Finish Techniques

Heirlooming

Species Availability

Rustic Alder	Cherry	Rustic Hickory	Laminate	Maple	Oak
Alder	•	Hickory	box color	•	•

QUARTER ROUND MOULDING



QRM

95

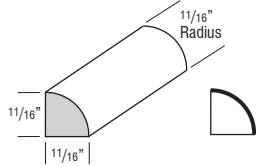

- One 8' section.

Finish Techniques

Heirlooming

Species Availability

Rustic Alder	Cherry	Rustic Hickory	Laminate	Maple	Oak
Alder	•	Hickory	box color	•	•

SHOE - CONVEX INSIDE CORNER



SHM8

73

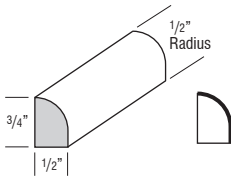

- One 8' section.

Finish Techniques

Heirlooming

Species Availability

Rustic Alder	Cherry	Rustic Hickory	Laminate	Maple	Oak
Alder	•	Hickory	box color	•	•

WINDOW CASING

WINDOW CASING - TRADITIONAL



WCT8

194

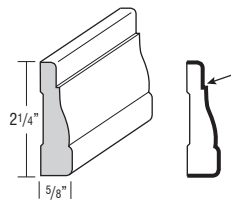

- One 8' section.

Finish Techniques

Heirlooming

Species Availability

Rustic Alder	Cherry	Rustic Hickory	Laminate	Maple	Oak
Alder	•	Hickory	box color	•	•

DESCRIPTION MODEL PRICE

VALANCES

ARCHED VALANCE



AV36

128

AV48

155

AV60

176

AV72

214

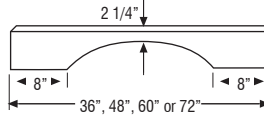

- Side shoulders are 8" wide (6" trimmable each end).
- Bottom edge has 3/16" radius.
- 3/4" thick.

Finish Techniques

Heirlooming

Species Availability

Rustic Alder	Cherry	Rustic Hickory	Laminate	Maple	Oak
•	•	•	box color	•	•

FURNITURE VALANCE



FV36

128

FV48

155

FV60

176

FV72

214

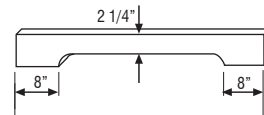

- Side shoulders are 8" wide (6" trimmable each end).
- Bottom edge has 3/16" radius profile on face.
- 3/4" thick.

Finish Techniques

Heirlooming

Species Availability

Rustic Alder	Cherry	Rustic Hickory	Laminate	Maple	Oak
•	•	•	box color	•	•

RAISED PANEL ARCH VALANCE



JRPV30

1158

JRPV36

1220

JRPV42

1278

JRPV48

1422

JRPV54

1572

JRPV60

1723

JRPV72

2080

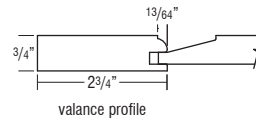
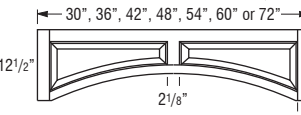

- Trimmable up to 1 3/4" per side.
- Recommended for use with hearths, see page 111.
- Center height 8".
- Raised panel profile is unique to this item and does not match any door style.
- Ends are pocket drilled for installation to adjacent cabinet frames.

Finish Techniques

Heirlooming

Species Availability

Rustic Alder	Cherry	Rustic Hickory	Laminate	Maple	Oak
•	•	•	box color	•	•

Finished edges indicated by bold lines on side view drawings.
Glazed edges indicated by arrows on side view drawings.

DESCRIPTION MODEL PRICE

RECESSED PANEL ARCH VALANCE



JRCPV30	1158
JRCPV36	1220
JRCPV42	1278
JRCPV48	1422
JRCPV54	1572
JRCPV60	1723
JRCPV72	2080

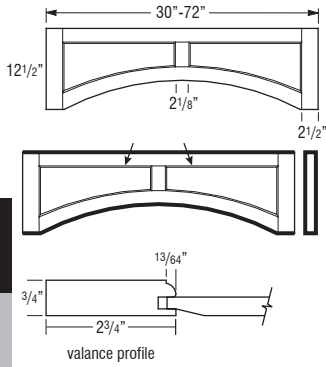

- Trimable up to 1 3/4" per side.
- Recommended for use with hearths, see page 111.
- Center height 8".
- Ends are pocket drilled for installation to adjacent cabinet frames.

Finish Techniques

Heirlooming
•

Species Availability

Rustic Alder	Cherry	Rustic Hickory	Laminate	Maple	Oak
•	•		box color	•	•

STRAIGHT VALANCE



VV48	123
VV72	169
VV96	253
VV120 ♦	343

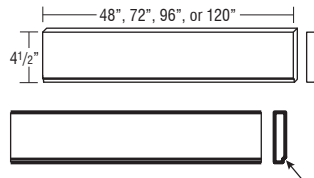

- Trimable.
- 3/4" thick.

Finish Techniques

Heirlooming
•

Species Availability

Rustic Alder	Cherry	Rustic Hickory	Laminate	Maple	Oak
•	•	•	box color	•	•

♦ Only available in Cherry and Maple.

TABLE OF CONTENTS – EMBELLISHMENTS

Decorative Legs294
 Decorative Feet299
 Decorative Corbels & Shelf Supports300
 Shelves305
 Decorative Hardware307

DESCRIPTION MODEL PRICE
DECORATIVE LEGS

BUNGALOW LEG, 3" WIDE, 34 1/2" HIGH



BUNLEG3

1027

- Trimable.

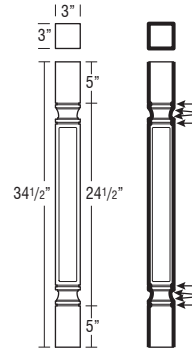

Finish Techniques

Heirlooming
•

Species Availability

Rustic Alder	Cherry	Rustic Hickory	Laminate	Maple	Oak
•	•		box color	•	•

BUNGALOW LEG, 5" WIDE, 34 1/2" HIGH



BUNLEG5

1842

- Trimable.

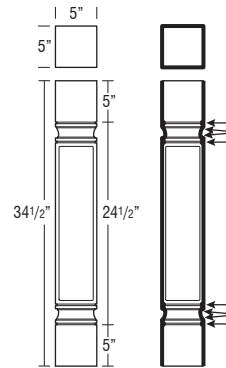

Finish Techniques

Heirlooming
•

Species Availability

Rustic Alder	Cherry	Rustic Hickory	Laminate	Maple	Oak
•	•		box color	•	•

Finished edges indicated by bold lines on side view drawings.
 Glazed edges indicated by arrows on side view drawings.

DESCRIPTION

MODEL

PRICE

**COSMO LEG,
35 1/4" HIGH**



JCOSMOLEG

851

- Trimmable.
- Leg is designed with three pieces joined together.

Finish Techniques

Heirlooming
•

Species Availability

Rustic Alder	Cherry	Rustic Hickory	Laminate	Maple	Oak
Alder	•	box color	•	•	•

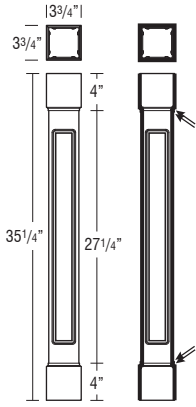

**ENGLISH COUNTRY
LEG, 35 1/4" HIGH**



JENGCNTYLEG

829

- Trimmable.

Finish Techniques

Heirlooming
•

Species Availability

Rustic Alder	Cherry	Rustic Hickory	Laminate	Maple	Oak
Alder	•	box color	•	•	•

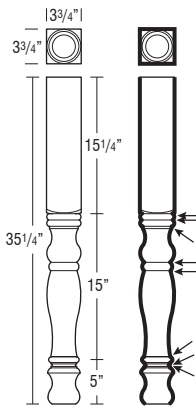

**ENGLISH ISLAND COLUMN,
5" WIDE, 35 1/4" HIGH**



ENGLISHCOLUMN

1425

- Trimmable.

Finish Techniques

Heirlooming
•

Species Availability

Rustic Alder	Cherry	Rustic Hickory	Laminate	Maple	Oak
Alder	•	box color	•	•	•

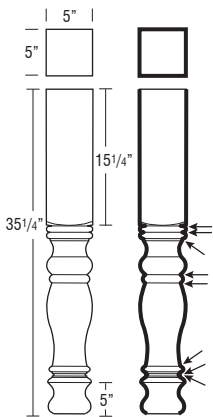

DESCRIPTION

MODEL

PRICE

**ESTATE LEG, SMALL,
2 3/4" WIDE,
35 1/4" HIGH**



JESTATELEGS

793

- Trimmable.

Finish Techniques

Heirlooming
•

Species Availability

Rustic Alder	Cherry	Rustic Hickory	Laminate	Maple	Oak
Alder	•	box color	•	•	•

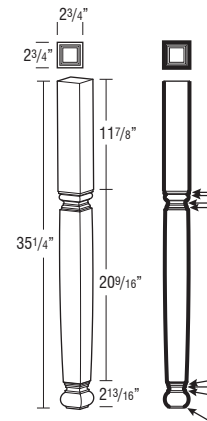

**ESTATE LEG SPLIT,
SMALL, 2 3/4" WIDE,
35 1/4" HIGH**



JESTATELEGSS

556

- Trimmable.

Finish Techniques

Heirlooming
•

Species Availability

Rustic Alder	Cherry	Rustic Hickory	Laminate	Maple	Oak
Alder	•	box color	•	•	•

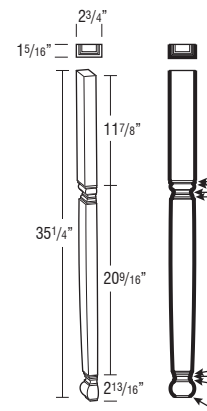

**ESTATE LEG,
35 1/4" HIGH**



JESTATELEG

881

- Trimmable.

Finish Techniques

Heirlooming
•

Species Availability

Rustic Alder	Cherry	Rustic Hickory	Laminate	Maple	Oak
Alder	•	box color	•	•	•

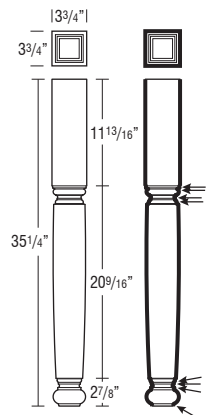

Finished edges indicated by bold lines on side view drawings.
Glazed edges indicated by arrows on side view drawings.

DESCRIPTION MODEL PRICE

Gaelic Leg, 4 1/2" wide, 35 1/2" high



GaelicLeg

1501

- Trimtable.

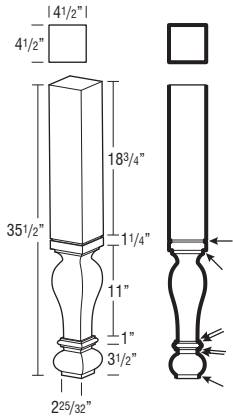

Finish Techniques

Heirlooming
•

Species Availability

Rustic Alder	Cherry	Rustic Hickory	Laminate	Maple	Oak
•			box color	•	•

DESCRIPTION MODEL PRICE

Island Leg Tapered, 35 1/4" high



ISLEGTPRD

1396

- Trimtable.

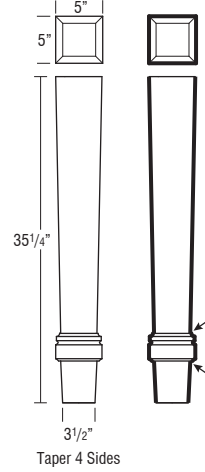

Finish Techniques

Heirlooming
•

Species Availability

Rustic Alder	Cherry	Rustic Hickory	Laminate	Maple	Oak
•			box color	•	•

ISLAND LEG, 2-SIDED, 35 1/4" HIGH 2SISLLEG 1032



- Trimtable.

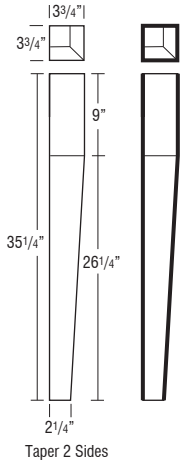

Finish Techniques

Heirlooming
•

Species Availability

Rustic Alder	Cherry	Rustic Hickory	Laminate	Maple	Oak
•			box color	•	•

METRO BAR COLUMN, 42 1/4" HIGH METBARCOLUMN 1254



- Trimtable.

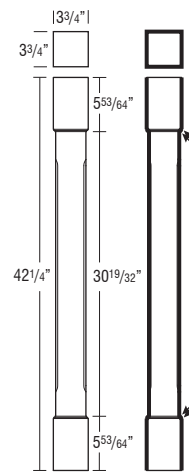

Finish Techniques

Heirlooming
•

Species Availability

Rustic Alder	Cherry	Rustic Hickory	Laminate	Maple	Oak
•			box color	•	•

ISLAND LEG, 4-SIDED, 35 1/4" HIGH 4SISLLEG 1160



- Trimtable.

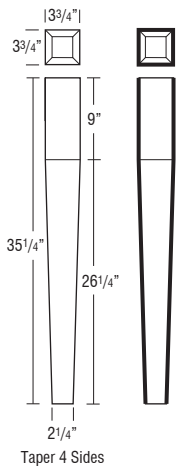

Finish Techniques

Heirlooming
•

Species Availability

Rustic Alder	Cherry	Rustic Hickory	Laminate	Maple	Oak
•			box color	•	•

METRO ISLAND COLUMN, 34 5/8" HIGH METISLCOLUMN 1149



- Trimtable.
- Leg is designed with three pieces joined together.

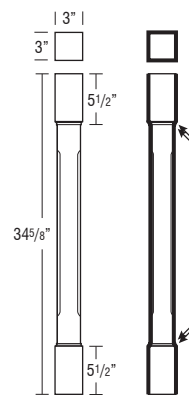

Finish Techniques

Heirlooming
•

Species Availability

Rustic Alder	Cherry	Rustic Hickory	Laminate	Maple	Oak
•			box color	•	•

Finished edges indicated by bold lines on side view drawings.
Glazed edges indicated by arrows on side view drawings.

DESCRIPTION

MODEL

PRICE

**MISSION LEG,
34 1/2" HIGH**



DLEMISSION

1033

- Trimmable.

Finish Techniques

Heirlooming

-

Species Availability

Rustic Alder	Cherry	Rustic Hickory	Laminate	Maple	Oak
			box color		
	•			•	•

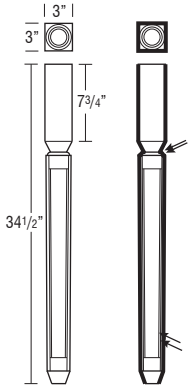

DESCRIPTION

MODEL

PRICE

**SQUARE ISLAND LEG,
3" x 3", 35 1/4" HIGH**



JSQISLLEG3

713

- Trimmable.

Finish Techniques

Heirlooming

-

Species Availability

Rustic Alder	Cherry	Rustic Hickory	Laminate	Maple	Oak
			box color		
	•			•	•

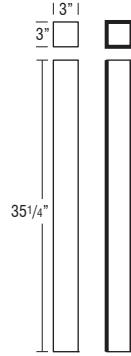

**PALLADIAN ISLAND LEG,
34 1/2" HIGH**



JPALLALEGT

1033

- Trimmable.

Finish Techniques

Heirlooming

-

Species Availability

Rustic Alder	Cherry	Rustic Hickory	Laminate	Maple	Oak
			box color		
	•			•	•

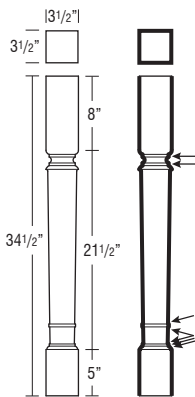

**SQUARE ISLAND LEG,
4" x 4", 35 1/4" HIGH**



JSQISLLEG4

824

- Trimmable.

Finish Techniques

Heirlooming

-

Species Availability

Rustic Alder	Cherry	Rustic Hickory	Laminate	Maple	Oak
			box color		
	•			•	•

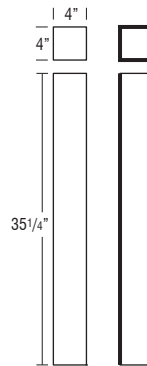

**SPOOL LEG,
34 1/2" HIGH**



SPLEG

1033

- Trimmable.

Finish Techniques

Heirlooming

-

Species Availability

Rustic Alder	Cherry	Rustic Hickory	Laminate	Maple	Oak
			box color		
	•			•	•

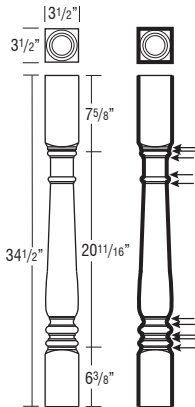

**SQUARE ISLAND LEG,
5" x 5", 35 1/4" HIGH**



JSQISLLEG5

907

- Trimmable.

Finish Techniques

Heirlooming

-

Species Availability

Rustic Alder	Cherry	Rustic Hickory	Laminate	Maple	Oak
			box color		
	•			•	•

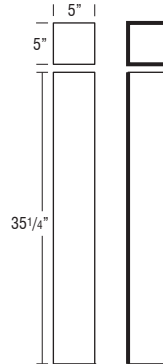

Finished edges indicated by bold lines on side view drawings.
Glazed edges indicated by arrows on side view drawings.

DESCRIPTION MODEL PRICE

**SQUARE ISLAND LEG,
6" x 6", 35 1/4" HIGH**



JSQISLEG6

1114

- Trimable.

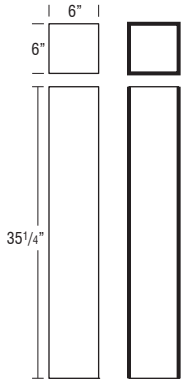

Finish Techniques

Heirlooming
•

Species Availability

Rustic Alder	Cherry	Rustic Hickory	Laminate	Maple	Oak
Alder	•		box color	•	•

DESCRIPTION MODEL PRICE

**TURNTURNED POST ISLAND LEG,
35 1/4" HIGH**



TURNTURNEDPOST

793

- Trimable.

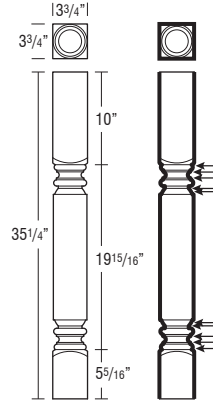

Finish Techniques

Heirlooming
•

Species Availability

Rustic Alder	Cherry	Rustic Hickory	Laminate	Maple	Oak
Alder	•	Hickory	box color	•	•

**SQUARE BAR LEG,
4" x 4", 42 1/4" HIGH**



JSQBARLEG4

930

- Trimable.

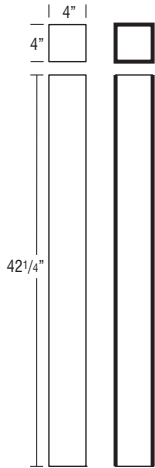

Finish Techniques

Heirlooming
•

Species Availability

Rustic Alder	Cherry	Rustic Hickory	Laminate	Maple	Oak
Alder	•		box color	•	•

**URN LEG,
35 1/4" HIGH**



JURNLEG

909

- Trimable.

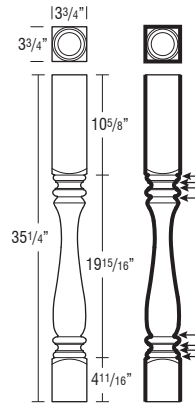

Finish Techniques

Heirlooming
•

Species Availability

Rustic Alder	Cherry	Rustic Hickory	Laminate	Maple	Oak
Alder	•		box color	•	•

**SQUARE BAR LEG,
6" x 6", 42 1/4" HIGH**



JSQBARLEG6

1287

- Trimable.

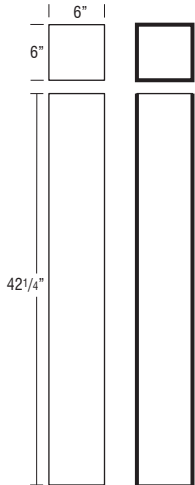

Finish Techniques

Heirlooming
•

Species Availability

Rustic Alder	Cherry	Rustic Hickory	Laminate	Maple	Oak
Alder	•		box color	•	•

**URN LEG, 5" WIDE,
35 1/4" HIGH**



JURNLEGL

1223

- Trimable.

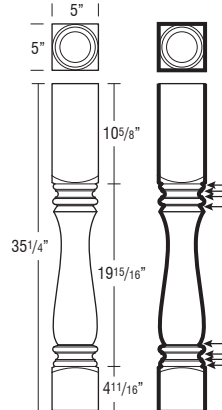

Finish Techniques

Heirlooming
•

Species Availability

Rustic Alder	Cherry	Rustic Hickory	Laminate	Maple	Oak
Alder	•		box color	•	•

Finished edges indicated by bold lines on side view drawings.
Glazed edges indicated by arrows on side view drawings.

DESCRIPTION MODEL PRICE
DECORATIVE FEET

COSMO FOOT, 4" HIGH JCOSFOOT 328



• Recommended for applications without toekicks.

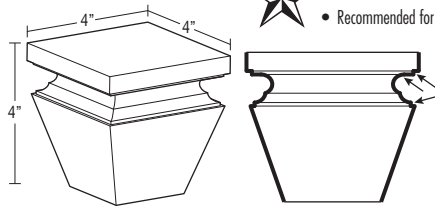

Finish Techniques

Heirlooming
•

Species Availability

Rustic Alder	Cherry	Rustic Hickory	Laminate	Maple	Oak
Alder	•		box color	•	•

DESCRIPTION MODEL PRICE

METROPOLITAN FOOT, 4 5/8" HIGH JMETFOT 237

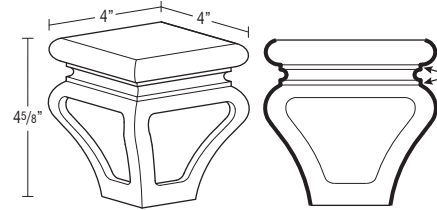

Finish Techniques

Heirlooming
•

Species Availability

Rustic Alder	Cherry	Rustic Hickory	Laminate	Maple	Oak
Alder	•		box color	•	•

CRAFTSMAN FOOT, 4 1/2" HIGH JCRAFTFOOT 185



• Trimable.

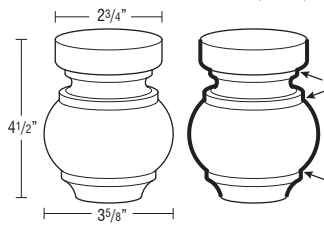

Finish Techniques

Heirlooming
•

Species Availability

Rustic Alder	Cherry	Rustic Hickory	Laminate	Maple	Oak
Alder	•		box color	•	•

PALLADIAN FOOT, 4 1/2" HIGH JPALLAFOOT 237

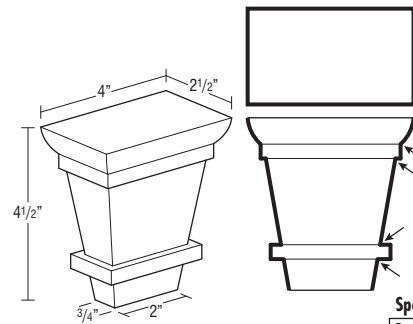

Finish Techniques

Heirlooming
•

Species Availability

Rustic Alder	Cherry	Rustic Hickory	Laminate	Maple	Oak
Alder	•		box color	•	•

KENSINGTON BUN FOOT, 4 1/2" HIGH JCRBUNFOOT 185



• Trimable.

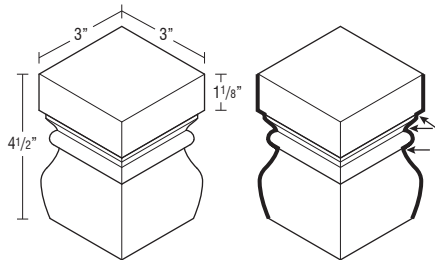

Finish Techniques

Heirlooming
•

Species Availability

Rustic Alder	Cherry	Rustic Hickory	Laminate	Maple	Oak
Alder	•		box color	•	•

LARGE SQUARE FOOT, 5" HIGH LGSQFOOT 451



• Trimable.

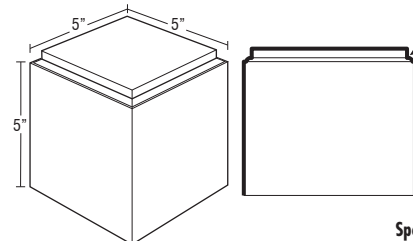

Finish Techniques

Heirlooming
•

Species Availability

Rustic Alder	Cherry	Rustic Hickory	Laminate	Maple	Oak
Alder	•		box color	•	•

MADLINE FOOT, 4 1/2" HIGH JMADEFOOT 328

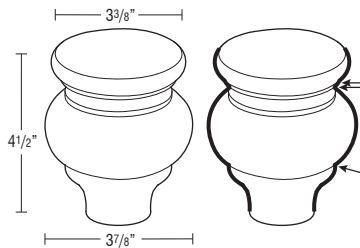

Finish Techniques

Heirlooming
•

Species Availability

Rustic Alder	Cherry	Rustic Hickory	Laminate	Maple	Oak
Alder	•		box color	•	•

Finished edges indicated by bold lines on side view drawings.
 Glazed edges indicated by arrows on side view drawings.

DESCRIPTION MODEL PRICE

LILLE FOOT, 4 1/2" HIGH



LIFOOT

430

- Recommended for applications without toekicks.

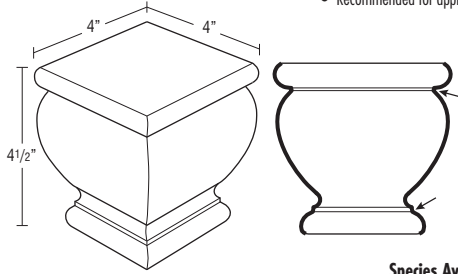

Finish Techniques

Heirlooming
•

Species Availability

Rustic Alder	Cherry	Rustic Hickory	Laminate	Maple	Oak
Alder	•		box color	•	•

TAPERED LEG, 6" HIGH



TAPLG

319

- Trimmable.

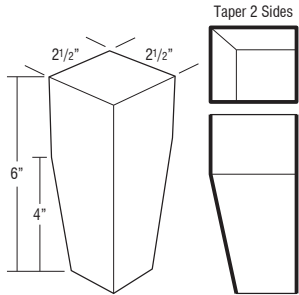

Finish Techniques

Heirlooming
•

Species Availability

Rustic Alder	Cherry	Rustic Hickory	Laminate	Maple	Oak
Alder	•		box color	•	•

TOEKICK TULIP FOOT, 4 5/8" HIGH



TKTLFOOT

514

- Trimmable.

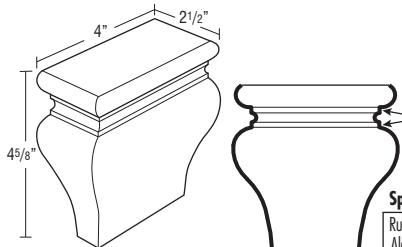

Finish Techniques

Heirlooming
•

Species Availability

Rustic Alder	Cherry	Rustic Hickory	Laminate	Maple	Oak
Alder	•		box color	•	•

TULIP FOOT, 4 5/8" HIGH



TLFOOT

478

- Trimmable.

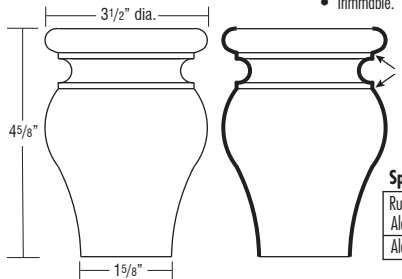

Finish Techniques

Heirlooming
•

Species Availability

Rustic Alder	Cherry	Rustic Hickory	Laminate	Maple	Oak
Alder	•		box color	•	•

DESCRIPTION MODEL PRICE
DECORATIVE CORBELS & SHELF SUPPORTS

9" SMALL CORBEL



SMCORBEL

646

- Not intended for cabinet or freestanding countertop support. For substantial weight support, use a floor mounted support such as a Decorative Leg.

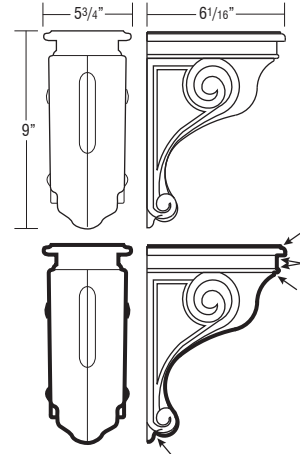

Finish Techniques

Heirlooming
•

Species Availability

Rustic Alder	Cherry	Rustic Hickory	Laminate	Maple	Oak
Alder	•		box color	•	•

13" LARGE CORBEL



LGCORBEL

821

- Not intended for cabinet or freestanding countertop support. For substantial weight support, use a floor mounted support such as a Decorative Leg.

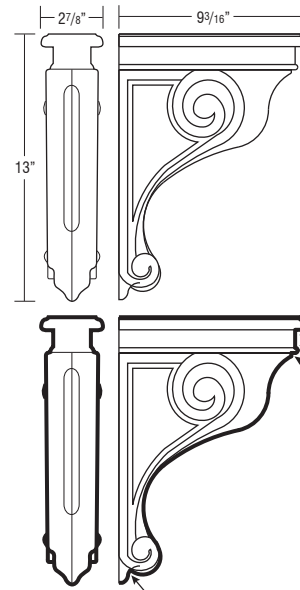

Finish Techniques

Heirlooming
•

Species Availability

Rustic Alder	Cherry	Rustic Hickory	Laminate	Maple	Oak
Alder	•		box color	•	•

9" ART CORBEL



CORBELART9

749

- Not intended for cabinet or freestanding countertop support. For substantial weight support, use a floor mounted support such as a Decorative Leg.

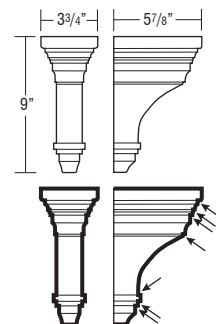

Finish Techniques

Heirlooming
•

Species Availability

Rustic Alder	Cherry	Rustic Hickory	Laminate	Maple	Oak
Alder	•		box color	•	•

Finished edges indicated by bold lines on side view drawings.
Glazed edges indicated by arrows on side view drawings.

DESCRIPTION

MODEL

PRICE

9" CLASSIC REVIVAL CORBEL



CORBELCR9

749

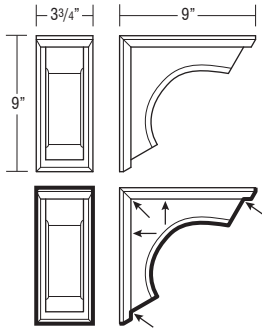

- Not intended for cabinet or freestanding countertop support. For substantial weight support, use a floor mounted support such as a Decorative Leg.

Finish Techniques

Heirlooming
•

Species Availability

Rustic Alder	Cherry	Rustic Hickory	Laminate	Maple	Oak
Alder	•	Hickory	box color	•	•

DESCRIPTION

MODEL

PRICE

11 1/4" COVE CORBEL



CORBELCOVE11

276

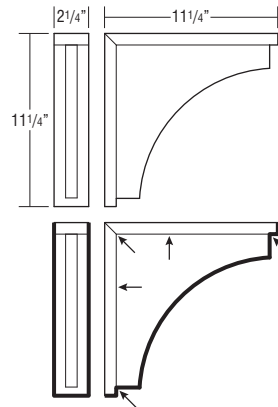

- Not intended for cabinet or freestanding countertop support. For substantial weight support, use a floor mounted support such as a Decorative Leg.

Finish Techniques

Heirlooming
•

Species Availability

Rustic Alder	Cherry	Rustic Hickory	Laminate	Maple	Oak
Alder	•	Hickory	box color	•	•

13" LARGE COSMO CORBEL DEEP



JCORBELCOS13D

1738

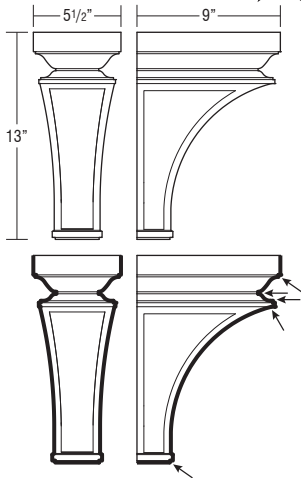

- Not intended for cabinet or freestanding countertop support. For substantial weight support, use a floor mounted support such as a Decorative Leg.

Finish Techniques

Heirlooming
•

Species Availability

Rustic Alder	Cherry	Rustic Hickory	Laminate	Maple	Oak
Alder	•	Hickory	box color	•	•

6" MISSION CORBEL



CORBELMIS6

556

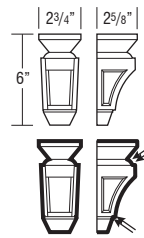

- Not intended for cabinet or freestanding countertop support. For substantial weight support, use a floor mounted support such as a Decorative Leg.

Finish Techniques

Heirlooming
•

Species Availability

Rustic Alder	Cherry	Rustic Hickory	Laminate	Maple	Oak
Alder	•	Hickory	box color	•	•

9" MISSION CORBEL



CORBELMIS9

646

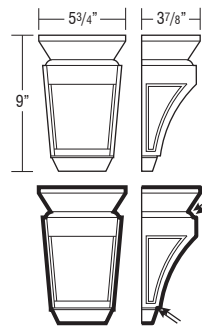

- Not intended for cabinet or freestanding countertop support. For substantial weight support, use a floor mounted support such as a Decorative Leg.

Finish Techniques

Heirlooming
•

Species Availability

Rustic Alder	Cherry	Rustic Hickory	Laminate	Maple	Oak
Alder	•	Hickory	box color	•	•

7" COVE CORBEL



CORBELCOVE7

254

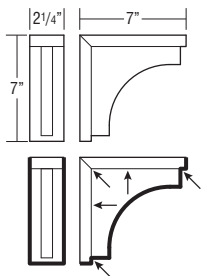

- Not intended for cabinet or freestanding countertop support. For substantial weight support, use a floor mounted support such as a Decorative Leg.

Finish Techniques

Heirlooming
•

Species Availability

Rustic Alder	Cherry	Rustic Hickory	Laminate	Maple	Oak
Alder	•	Hickory	box color	•	•

5" OLD WORLD CORBEL

CORBELOWD5

428

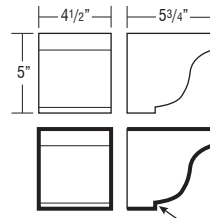

- Not intended for cabinet or freestanding countertop support. For substantial weight support, use a floor mounted support such as a Decorative Leg.

Finish Techniques

Heirlooming
•

Species Availability

Rustic Alder	Cherry	Rustic Hickory	Laminate	Maple	Oak
Alder	•	Hickory	box color	•	•

Finished edges indicated by bold lines on side view drawings.
Glazed edges indicated by arrows on side view drawings.

DESCRIPTION

MODEL

PRICE

11 1/4" SNACK BAR SUPPORT



SBS

233

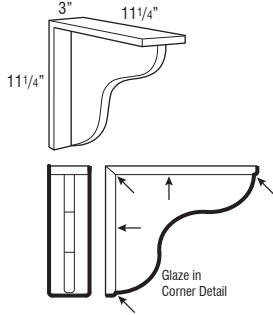

- Not intended for cabinet or freestanding countertop support. For substantial weight support, use a floor mounted support such as a Decorative Leg.

Finish Techniques

Heirlooming
•

Species Availability

Rustic Alder	Cherry	Rustic Hickory	Laminate	Maple	Oak
•		•	box color	•	•

11 1/2" ARTS & CRAFTS BRACKET



JBRACKETART

469

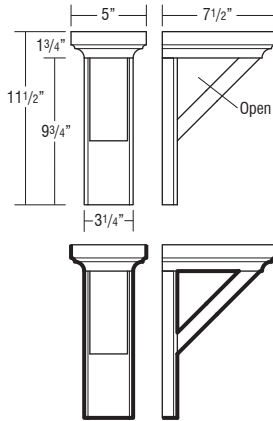

- Not intended for cabinet or freestanding countertop support. For substantial weight support, use a floor mounted support such as a Decorative Leg.

Finish Techniques

Heirlooming
•

Species Availability

Rustic Alder	Cherry	Rustic Hickory	Laminate	Maple	Oak
•			box color	•	•

12" CRAFTSMAN OPEN BRACKET



JCORBELCRAFTO

888

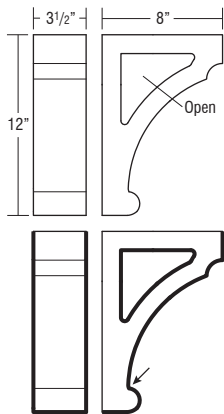

- Not intended for cabinet or freestanding countertop support. For substantial weight support, use a floor mounted support such as a Decorative Leg.

Finish Techniques

Heirlooming
•

Species Availability

Rustic Alder	Cherry	Rustic Hickory	Laminate	Maple	Oak
•			box color	•	•

DESCRIPTION

MODEL

PRICE

5 1/2" TRIAD CORBEL



CORBELTRIAD6

444

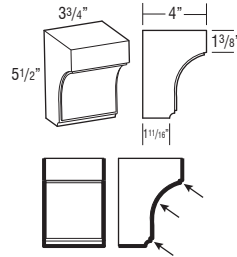

- Not intended for cabinet or freestanding countertop support. For substantial weight support, use a floor mounted support such as a Decorative Leg.

Finish Techniques

Heirlooming
•

Species Availability

Rustic Alder	Cherry	Rustic Hickory	Laminate	Maple	Oak
•			box color	•	•

9" TRIAD CORBEL, NARROW



CORBELTRIAD9N

532

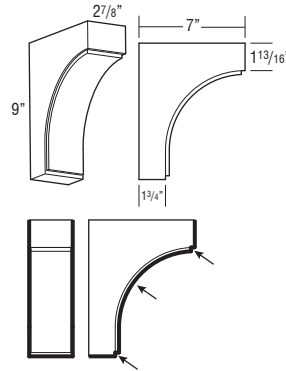

- Not intended for cabinet or freestanding countertop support. For substantial weight support, use a floor mounted support such as a Decorative Leg.

Finish Techniques

Heirlooming
•

Species Availability

Rustic Alder	Cherry	Rustic Hickory	Laminate	Maple	Oak
•			box color	•	•

12" TRIAD CORBEL



CORBELTRIAD12

590

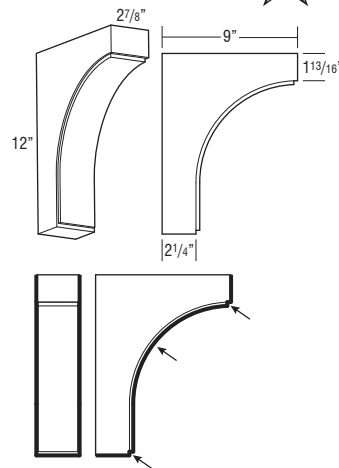

- Not intended for cabinet or freestanding countertop support. For substantial weight support, use a floor mounted support such as a Decorative Leg.

Finish Techniques

Heirlooming
•

Species Availability

Rustic Alder	Cherry	Rustic Hickory	Laminate	Maple	Oak
•			box color	•	•

Finished edges indicated by bold lines on side view drawings.
Glazed edges indicated by arrows on side view drawings.

DESCRIPTION

MODEL

PRICE

9" BAUHAUS CORBEL



CORBELBAUAL9

553

CORBELBAUWI9

553

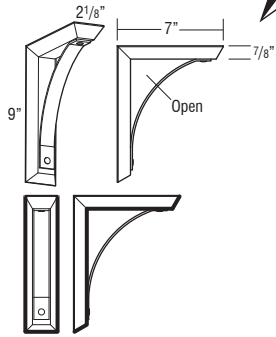

- Finishes available: Brushed Aluminum (AL) and Wrought Iron (WI).
- Not intended for cabinet or freestanding countertop support. For substantial weight support, use a floor mounted support such as a Decorative Leg.

Finish Techniques

Heirlooming
•

Species Availability

Rustic Alder	Cherry	Rustic Hickory	Laminate	Maple	Oak
•			box color	•	•

12" BAUHAUS CORBEL



CORBELBAUAL12

691

CORBELBAUWI12

691

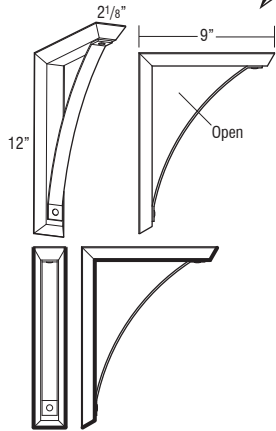

- Finishes available: Brushed Aluminum (AL) and Wrought Iron (WI).
- Not intended for cabinet or freestanding countertop support. For substantial weight support, use a floor mounted support such as a Decorative Leg.

Finish Techniques

Heirlooming
•

Species Availability

Rustic Alder	Cherry	Rustic Hickory	Laminate	Maple	Oak
•			box color	•	•

DESCRIPTION

MODEL

PRICE

SINGLE OUTLET COVER



JSOC

161

- White screws included.

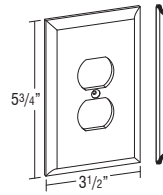

Finish Techniques

Heirlooming

Species Availability

Rustic Alder	Cherry	Rustic Hickory	Laminate	Maple	Oak
•			box color	•	•

SINGLE ROCKER PLATE



JSRC

161

- White screws included.

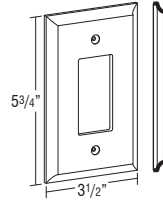

Finish Techniques

Heirlooming

Species Availability

Rustic Alder	Cherry	Rustic Hickory	Laminate	Maple	Oak
•			box color	•	•

Finished edges indicated by bold lines on side view drawings.
Glazed edges indicated by arrows on side view drawings.

DESCRIPTION MODEL PRICE
CONTEMPORARY EMBELLISHMENTS

METAL FOOT, SQUARE	FOOTMETAL	247
---------------------------	------------------	------------

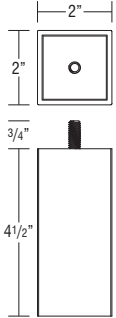

- Brushed Aluminum
- Includes hanger bolt with 5/16-18 threads.

INDUSTRIAL BRACKET, LOOP, 8 7/8" DEEP	BRACKETIND9SS	540
	BRACKETIND9GMG	556
	BRACKETIND9WI	405

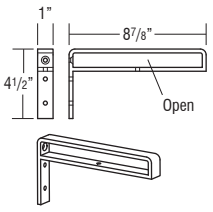

- On the stainless steel versions, the screws are countersunk.
- Finishes available: Stainless Steel (SS), Gun Metal Gray (GMG), and Wrought Iron (WI).
- Open area for 8" deep shelf placement is 15/16" high, shelf is to be secured with a screw in the bottom loop.
- Pre-drilled mounting holes for easy installation.
- 1/4" material thickness.
- Not intended for cabinet or freestanding countertop support. For substantial weight support, use a floor mounted support such as a decorative leg.
- Must be properly installed into a structural member of the wall.
- Sold individually. Recommended to use two brackets on shelves up to 48" wide, additional brackets should be added on wider shelves.

INDUSTRIAL BRACKET, LOOP, 12 7/8" DEEP	BRACKETIND13SS	586
	BRACKETIND13GMG	637
	BRACKETIND13WI	464

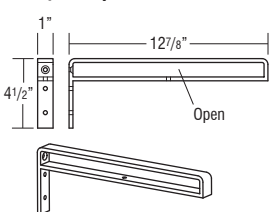

- On the stainless steel versions, the screws are countersunk.
- Finishes available: Stainless Steel (SS), Gun Metal Gray (GMG), and Wrought Iron (WI).
- Open area for 12" deep shelf placement is 15/16" high, shelf is to be secured with a screw in the bottom loop.
- Pre-drilled mounting holes for easy installation.
- 1/4" material thickness.
- Not intended for cabinet or freestanding countertop support. For substantial weight support, use a floor mounted support such as a decorative leg.
- Must be properly installed into a structural member of the wall.
- Sold individually. Recommended to use two brackets on shelves up to 48" wide, additional brackets should be added on wider shelves.

INDUSTRIAL BRACKET, STRAIGHT, 8 1/2" DEEP	STBRACKETIND9SS	491
	STBRACKETIND9G	505
	STBRACKETIND9WI	368

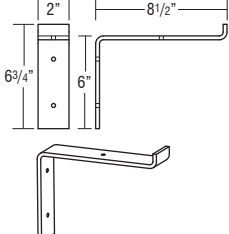

- On the stainless steel versions, the screws are countersunk.
- Finishes available: Stainless Steel (SS), Gun Metal Gray (G), and Wrought Iron (WI).
- Pre-drilled mounting holes for easy installation.
- 1/4" material thickness.
- Not intended for cabinet or freestanding countertop support. For substantial weight support, use a floor mounted support such as a Decorative Leg.
- Must be properly installed into a structural member of the wall.
- Sold individually. Recommended to use two brackets on shelves up to 48" wide, additional brackets should be added on wider shelves.

INDUSTRIAL BRACKET, STRAIGHT, 12 1/2" DEEP	STBRACKETIND13S	532
	STBRACKETIND13G	579
	STBRACKETIND13W	421

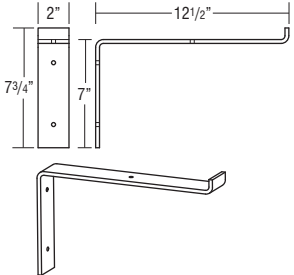

- On the stainless steel versions, the screws are countersunk.
- Finishes available: Stainless Steel (S), Gun Metal Gray (G), and Wrought Iron (W).
- Pre-drilled mounting holes for easy installation.
- 1/4" material thickness.
- Not intended for cabinet or freestanding countertop support. For substantial weight support, use a floor mounted support such as a Decorative Leg.
- Must be properly installed into a structural member of the wall.
- Sold individually. Recommended to use two brackets on shelves up to 48" wide, additional brackets should be added on wider shelves.

DESCRIPTION

MODEL

PRICE

SHELVES

FLOATING SHELVES

24", 30", 36",
42", 48", 54", 60"

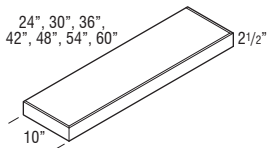

Maximum Weight Capacity per Shelf	
FS24	25 lbs.
FS30	31 lbs.
FS36	37 lbs.
FS42	43 lbs.
FS48	50 lbs.
FS54	56 lbs.
FS60	62 lbs.

FS24	500
FS30	570
FS36	643
FS42	712
FS48 ♦	914
FS54 ♦	973
FS60 ♦	1032

- 3/4" thick solid-wood front, back, and ends. 3/8" thick veneered Medium Density Fiberboard (MDF) top and bottom. When a Paint finish is specified, veneer may not be applied. Front and ends are mitered together.
- Includes wood mounting plate with metal brackets. Once installed, mounting system is fully concealed.
- Not trimmable.

Finish Techniques

Heirlooming

Species Availability

Rustic	Cherry	Rustic	Laminate	Maple	Oak
Alder	•	Hickory	box color	•	•

♦ Only available in Cherry and Maple.

**MODERN CORNER SHELF,
30" x 30" x 3/4"**

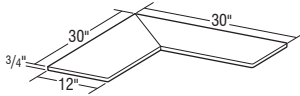

MDCCRNHLF	895
------------------	------------

- Constructed of 3/4" wood panels.
- Top, bottom, front, and sides are finished, back two edges are not finished.

Finish Techniques

Heirlooming
•

Species Availability

Rustic	Cherry	Rustic	Laminate	Maple	Oak
Alder	•	Hickory	box color	•	•

**MODERN CORNER
FLOATING SHELF,
30" x 30" x 2 1/2"**

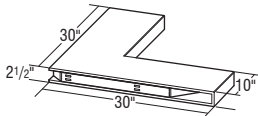

MDFLCRNSHLF	2895
--------------------	-------------

- Installation kit included.
- Maximum weight capacity is 52 lbs.
- 3/4" thick solid-wood front and ends. 3/8" thick veneered top and bottom.
- Not trimmable.

Finish Techniques

Heirlooming
•

Species Availability

Rustic	Cherry	Rustic	Laminate	Maple	Oak
Alder	•	Hickory	box color	•	•

DESCRIPTION

MODEL

PRICE

**EXTERIOR SHELVES,
12", 18", 21", or 24" DEEP**

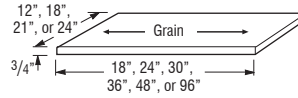

ES1218	97
ES1224	130
ES1230	162
ES1236	193
ES1248	250
ES1296†	516

ES1818	144
ES1824	193
ES1830	243
ES1836	292
ES1848	388
ES1896†	775

ES2118	169
ES2124	225
ES2130	283
ES2136	340
ES2148	451
ES2196†	905

ES2418	193
ES2424	258
ES2430	323
ES2436	388
ES2448	516
ES2496†	1033

- Wood 3/4" panels are veneered furniture board finished both sides, and front and side edges (back edge is not finished).
- Not available in wood grain laminates.
- Shelves can be ordered in APC.

†5 day Express Response not available on items over 48".

Custom Modifications

ID	RD
•	•

Finish Techniques

Heirlooming

Species Availability

Rustic	Cherry	Rustic	Laminate	Maple	Oak
Alder	•	Hickory	box color	•	•

DESCRIPTION MODEL PRICE

FULL DEPTH INTERIOR SHELVES

To Fit 12" & 24" Deep Cabinets

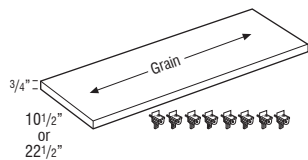

SK912	75
SK1212	75
SK1512	75
SK1812	92
SK2112	92
SK2412	92
SK2712	105
SK3012	105
SK3312	105
SK3612	122
SK3912	122
SK4212	122
SK4812	137
SK924	97
SK1224	97
SK1524	97
SK1824	114
SK2124	114
SK2424	114
SK2724	128
SK3024	128
SK3324	128
SK3624	144
SK3924	144
SK4224	144
SK4824	159

- SK_ _12 includes one 10 1/2" deep shelf. SK_ _24 includes one 22 1/2" deep shelf.
- Each kit includes 8 shelf pegs.
- Shelving material specific to construction option. See page 1 for construction details.
- Specify material when ordering.
- Full Depth Shelves will be shipped separate from the cabinet.
- If matching interior is desired, order shelf kit (SK_ _) with Matching Interior Plywood (MIP) modification.

Custom Modifications

CW	ID	MIP	RD
•	•	•	•

Construction Upgrades

APC
•

DESCRIPTION MODEL PRICE

GLASS SHELF KIT, 9" DEEP

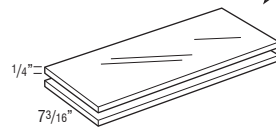

JGSK1209	170
JGSK1509	176
JGSK1809	181
JGSK2109	207
JGSK2409	217
JGSK2709	221
JGSK3009	225
JGSK3309	239
JGSK3609	251

- JGSK cannot be trimmed.
- Kit includes two 1/4" glass shelves.
- Example: JGSK1209 = 10 9/32" wide x 7 3/16" deep fits in W1230x9 cabinet.
- Not compatible with the FFD modification.
- Can support 15 lbs. per square foot.
- All glass shelf kits will be drop shipped separately from the cabinet order.

GLASS SHELF KIT, 12" DEEP

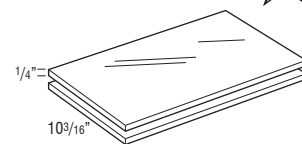

JGSK912	166
JGSK1212	170
JGSK1512	176
JGSK1812	181
JGSK2112	207
JGSK2412	217
JGSK2712	221
JGSK3012	225
JGSK3312	239
JGSK3612	251

- JGSK cannot be trimmed.
- Kit includes two 1/4" glass shelves.
- Example: JGSK1512 = 13 9/32" wide x 10 3/16" deep fits in W1530x12 cabinet.
- Not compatible with the FFD modification.
- Can support 15 lbs. per square foot.
- All glass shelf kits will be drop shipped separately from the cabinet order.

Custom Modifications

ID	RD
•	

GLASS SHELF KIT, DIAGONAL

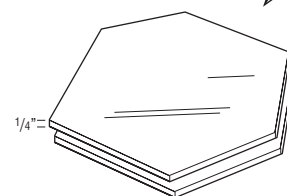

JGSKDW24 (Fits DW..2424)	344
JGSKDW27 (Fits DW..2727)	344

- JGSK cannot be trimmed.
- Kit includes two 1/4" glass shelves.
- Not available for 24" and 27" high Diagonal Wall cabinets. Shelf will not fit through door opening.
- Not available for Diagonal Wall cabinets specified with Peninsula modification.
- Not compatible with the FFD modification.
- Can support 15 lbs. per square foot.
- All glass shelf kits will be drop shipped separately from the cabinet order.

DESCRIPTION	MODEL	PRICE
DECORATIVE HARDWARE - KNOBS & PULLS		

ANTIQUPEWTER



KNOBM206 18
D: 1 1/4"
P: 1 1/16"



PULLM364 22
C/C: 3"
L: 4 5/8"
W: 1 7/16"
P: 15/16"



PULLM475 17
C/C: 3 3/4"
L: 5"
W: 9/16"
P: 1"

BLACK



KNOBT1017 35
C/C: 1 1/4"
L: 2"
W: 1 1/16"
P: 1 1/4"
Pairs best with PULLT1015



PULLT1015 49
C/C: 7"
L: 8"
W: 1 1/16"
P: 1 1/2"
Pairs best with KNOBT1017



KNOB1912 43
D: 1 1/4"
P: 1 3/16"



KNOBH951 16
L: 1 3/4"
W: 1"
P: 1"
B: 1 1/16" x 1/2"

D = Diameter
P = Projection (Hardware Depth)
L = Length
W = Width
B = Base
C/C = Center to Center

Installation screws included with each hardware piece.
Breakoff screws available for purchase separately as BRKOFFSCREW, see page 321.
Larger pulls may not be compatible with 5-piece drawer fronts on face frame openings of 9" wide or less.
See Door Style section for 5-piece drawer front dimensions when specifying decorative hardware.
For color images of decorative hardware, see company website.

DESCRIPTION	MODEL	PRICE
BLACK (cont'd)		



PULLH952 30
C/C: 3"
L: 4 1/4"
W: 1 1/2"
P: 11/16"



PULLM383 30
C/C: 5 1/16"
L: 6"
W: 1/2"
P: 1 1/16"



KNOBH136 13
L: 1 3/4"
W: 1/2"
P: 1 1/8"
B: 1/2"



PULLH130 16
C/C: 128mm
L: 6 3/8"
W: 7/16"
P: 1 1/8"



PULLH132 26
C/C: 224mm
L: 10"
W: 1/2"
P: 1 3/8"



BLACK IRON













KNOB1901 28
L: 1 7/16"
W: 1 1/4"
P: 1 1/8"
B: 15/16"



PULL1902 41
C/C: 128mm
L: 6 1/3"
W: 1 1/10"
P: 1 1/16"

DESCRIPTION	MODEL	PRICE
BLACK MIST 		
	KNOBH116 L: 1 5/16" W: 1 1/4" P: 1 1/8" B: 3/8"	15
	PULLH115 C/C: 128mm L: 6 3/8" W: 1/2" P: 1"	31

DESCRIPTION	MODEL	PRICE
CHROME 		
	KNOB1906 L: 1 1/16" W: 1 1/16" P: 1 1/8" B: 3/8"	43
	PULL1905 C/C: 128mm L: 6 3/8" W: 9/16" P: 1"	57
	PULL1904 C/C: 3 3/4" L: 5 1/4" W: 1" P: 1"	59

DESCRIPTION	MODEL	PRICE
GOLD 		
	KNOB1908 L: 1 1/4" W: 1 1/4" P: 1" B: 3/8" Pairs best with PULL1907	31
	PULL1907 C/C: 160mm L: 6 7/10" W: 2/5" P: 1 1/5" Pairs best with KNOB1908	52
	KNOB1909 L: 1 1/4" W: 1 1/4" P: 1 1/8" B: 3/4" Pairs best with PULL1910 or PULL1911	30
	PULL1910 C/C: 224mm L: 9 9/16" W: 3/4" P: 1 5/16" Pairs best with KNOB1909 or PULL1911	64
	PULL1911 C/C: 192mm L: 8 3/8" W: 3/4" P: 1 1/4" Pairs best with KNOB1909 or PULL1910	57

DESCRIPTION	MODEL	PRICE
HAMMERED BRONZE 		
	KNOBH913 L: 1 3/8" W: 1 3/8"	37

DESCRIPTION	MODEL	PRICE
ICE TEA 		
	KNOBH108 L: 1 7/16" W: 1 1/16" P: 1" B: 1/2"	10

D = Diameter
P = Projection (Hardware Depth)
L = Length
W = Width
B = Base
C/C = Center to Center

Installation screws included with each hardware piece.
 Breakoff screws available for purchase separately as BRKOFFSCREW, see page 321.
 Larger pulls may not be compatible with 5-piece drawer fronts on face frame openings of 9" wide or less.
 See Door Style section for 5-piece drawer front dimensions when specifying decorative hardware.
 For color images of decorative hardware, see company website.

DESCRIPTION MODEL PRICE

SATIN NICKEL



KNOBT002 41
C/C: 1 1/4"
L: 2"
W: 3/8"
P: 1 1/2"
Pairs best with PULLT001



PULLT001 28
C/C: 7"
L: 8"
W: 3/8"
P: 1 1/2"
Pairs best with KNOBT002



PULLH120 27
C/C: 160mm
L: 7 1/8"
W: 3/4"
P: 1"
Pairs best with PULLH122



PULLH122 49
C/C: 12"
L: 12 3/4"
W: 7/8"
P: 1 3/16"
Pairs best with PULLH120



PULLH105 32
C/C: 1"
L: 1 3/4"
W: 1"
P: 1 3/4"
Pairs best with PULLH106 or PULLH107



PULLH106 46
C/C: 160mm
L: 7"
W: 1"
P: 1 3/4"
Pairs best with PULLH105 or PULLH107



PULLH107 74
C/C: 12"
L: 13"
W: 1"
P: 1 13/16"
Pairs best with PULLH105 or PULLH106

D = Diameter
P = Projection (Hardware Depth)
L = Length
W = Width
B = Base
C/C = Center to Center

Installation screws included with each hardware piece.
Breakoff screws available for purchase separately as BRKOFFSCREW, see page 321.
Larger pulls may not be compatible with 5-piece drawer fronts on face frame openings of 9" wide or less.
See Door Style section for 5-piece drawer front dimensions when specifying decorative hardware.
For color images of decorative hardware, see company website.

DESCRIPTION MODEL PRICE

SATIN NICKEL (cont'd)



KNOB1420 18
D: 1 1/4"
P: 1 1/8"



KNOBH118 16
L: 1 5/16"
W: 1 5/16"
P: 1 3/16"
B: 7/8"



KNOBM549 17
D: 7/8"
P: 1"



PULLH50 48
C/C: 5"
L: 5"
W: 5/16"
P: 1 1/4"



PULLH63 41
C/C: 96mm
L: 4 1/8"
W: 1/2"
P: 1 1/16"



PULLH957 27
C/C: 3"
L: 4 1/4"
W: 1 1/2"
P: 11/16"





PULLM381 22
C/C: 5 1/16"
L: 6"
W: 1/2"
P: 1 1/16"







PULLM430 27
C/C: 5 1/16"
L: 7"
W: 15/32"
P: 1 7/16"





PULLM570 21
C/C: 5 1/16"
L: 5 7/8"
W: 1/2"
P: 1 3/16"

DESCRIPTION	MODEL	PRICE
SILVER STONE 		
	KNOBH127 D: 1 1/2" P: 1" B: 7/8"	18
	PULLH128 C/C: 160mm L: 7 1/2" W: 3/4" P: 1 1/16"	28

DESCRIPTION	MODEL	PRICE
STAINLESS STEEL 		
	KNOBH135 L: 1 3/4" W: 1/2" P: 1 1/8" B: 1/2" Pairs best with PULLH129 or PULLH131	13
	PULLH129 C/C: 128mm L: 6 3/8" W: 7/16" P: 1 1/8" Pairs best with KNOBH135 or PULLH131	16
	PULLH131 C/C: 224mm L: 10" W: 1/2" P: 1 3/8" Pairs best with KNOBH135 or PULLH129	25
	PULLH141 C/C: 128mm L: 7 3/8" W: 1/2" P: 1 1/4" Pairs best with PULLH142 or PULLH143	15

D = Diameter
P = Projection (Hardware Depth)
L = Length
W = Width
B = Base
C/C = Center to Center

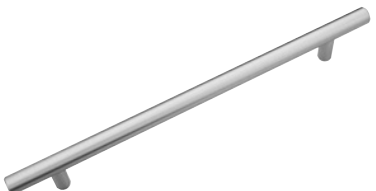
Installation screws included with each hardware piece.
 Breakoff screws available for purchase separately as BRKOFFSCREW, see page 321.
 Larger pulls may not be compatible with 5-piece drawer fronts on face frame openings of 9" wide or less.
 See Door Style section for 5-piece drawer front dimensions when specifying decorative hardware.
 For color images of decorative hardware, see company website.

DESCRIPTION	MODEL	PRICE
STAINLESS STEEL (cont'd) 		
	PULLH142 C/C: 192mm L: 9 15/16" W: 1/2" P: 1 1/4" Pairs best with PULLH141 or PULLH143	17
	PULLH143 C/C: 384mm L: 17 1/2" W: 1/2" P: 1 1/4" Pairs best with PULLH141 or PULLH142	26

DESCRIPTION	MODEL	PRICE
TUSCAN BRONZE 		
	KNOBH117 L: 1 5/16" W: 1 5/16" P: 1 3/16" B: 7/8" Pairs best with PULLH119	16
	PULLH119 C/C: 160mm L: 7 1/8" W: 3/4" P: 1" Pairs best with KNOBH117	39
	KNOBT013 D: 1 1/4" P: 1 1/16"	32

DESCRIPTION MODEL PRICE
DECORATIVE HARDWARE - TOUCH LATCH

TOUCH LATCH	TOUCLATCH	35
-------------	-----------	----

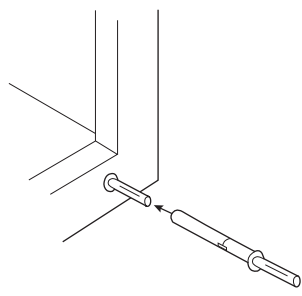

- Nylon gray mechanism with bumper tip.
- Face frame will need to be field drilled for insertion of the TOUCHLATCH, requires 25/64" (10mm) drill bit.
- Can be field adjusted for door gap depth, no tools required.
- For use on full overlay door styles only.
- Requires a soft touch to open the door, and door must be pushed closed to reset the TOUCHLATCH mechanism.
- Only for use on hinged doors, and can be used without decorative hardware. Not compatible with non-hinged doors such as pull-outs, Wall Vertical-lift (WVL.). For drawers, pull-outs, and other non-compatible cabinets, PULLH105 and PULLH106 are recommended (see page 309).

TABLE OF CONTENTS – ACCESSORIES

Cabinet Accessories311
 Roll Tray Kits317
 Stain, Paint, & Touch-up Tools318
 Guide Kits and Parts319
 Hinges320
 Doors, Drawer Fronts, & Drawers321
 Miscellaneous Parts321

DESCRIPTION MODEL PRICE

CABINET ACCESSORIES

BASE MIXER KIT

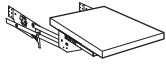

MIXKITFHSC18	1157
MIXKITFHSC21	1285
MIXKITFHSC24	1413

- Soft-close closing feature.
- Mixer shelf will be 3/4" thick, mixer shelf dimensions:
 18" wide: 11 3/4" wide x 20" deep.
 21" wide: 14 3/4" wide x 20" deep.
 24" wide: 17 3/4" wide x 20" deep.
- Maximum Weight Capacity for Mixer Shelf: 60 lbs.
- Mixer shelf locks in the fully open position. Release brackets lower the mixer shelf back into the cabinet.
- When in closed position, clearance above shelf is 17 5/8"; clearance below shelf is 7 3/4".
- Recommended for use in cabinets specified with APC.

Model	Application
MIXKITFHSC18	18" Base
MIXKITFHSC21	21" Base
MIXKITFHSC24	24" Base

BASE PAN STORAGE

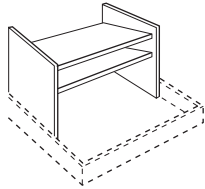

BPS24	588
BPS30	624
BPS36	696

- Roll tray not included.
- Insert consists of solid Maple sides and shelves. Back is edgebanded plywood.

Model	Application
BPS24	24" Base
BPS30	30" Base
BPS36	36" Base

DESCRIPTION

MODEL

PRICE

BASE WASTEBASKET LIDS

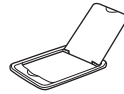

BWBLID	92
BWBFHLID	92

- Designed to be used with BWB__ and VWB__.
- BWBLID fits 35 quart wastebaskets. On double wastebasket cabinets, BWBLID can only be used on the front wastebasket.
- BWBFHLID fits 50 quart wastebaskets.
- Sold individually.

Model	BWBLID (35 qt. wastebasket)	BWBFHLID (50 qt. wastebasket)
BWB15	✓	
BWB152		
BWB18	Front only	
BWB21	Front only	
BWB15FH		✓
BWB18FH		✓
BWB15FH2		
BWB18FH2	Front only	
BWB15FHRT2		
BWB18FHRT2	Front only	
BWB21FH		Front only
BPT15WB		
BPT18WB		
BPT15WBFH		
BPT18WBFH		
VWB153421	✓	
VWB153221	✓	
VWB153221RT		
VWB153421	✓	
VWB153421RT	✓	

BROOM CLIP



BRMCLP

63

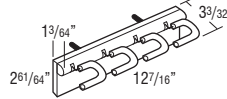

CABMAT™



CABMAT30

299

CABMAT33

299

CABMAT36

299

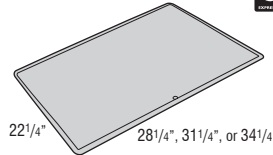

- Designed to capture spills and is removable for cleaning.
- See CabMat™ modification for easy size selection by cabinet model.
- Not trimmable. Can also be used in wider cabinets but will create a small void of unprotected area along the end panels.

CABMAT™ VANITY



CABMATV24

299

CABMATV30

299

CABMATV36

299

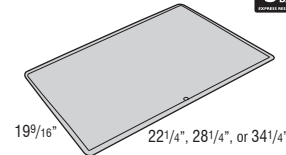

- Designed to capture spills and is removable for cleaning.
- See CabMat™ modification for easy size selection by cabinet model.
- Not trimmable. Can also be used in wider cabinets but will create a small void of unprotected area along the end panels.

DESCRIPTION MODEL PRICE

COOKING UTENSIL DIVIDER



CUDD24	276
CUDD30	308
CUDD36	340

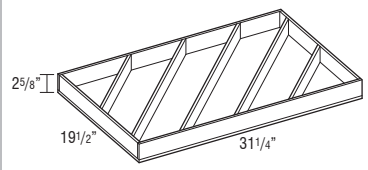
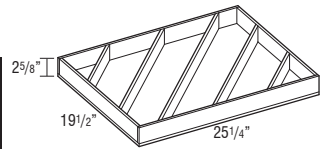
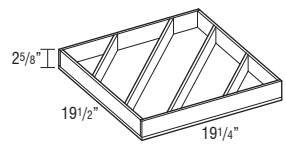

- Pre-assembled natural wood drawer insert (does not fit roll trays).
- Available in 24" deep cabinets only.

Model	Application
CUDD24	24" Base
CUDD30	30" Base
CUDD36	36" Base

CUTLERY INSERT WOOD ORGANIZER



CIW15	192
CIW18	205
CIW21	265
CIW24	284

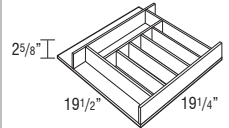
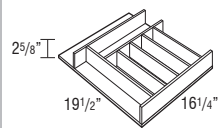
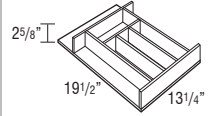
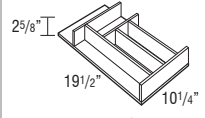

- Pre-assembled natural wood insert.
- Place a cabinet with a CIW next to the dishwasher for convenience.

Model	Application
CIW15	15" Base
CIW18	18" Base
CIW21	21" Base
CIW24	24" Base

DESCRIPTION MODEL PRICE

WOOD TIERED CUTLERY DIVIDER DRAWER



WTCD15	512
WTCD18	532
WTCD21	553
WTCD24	570
WTCD30	747
WTCD36	786

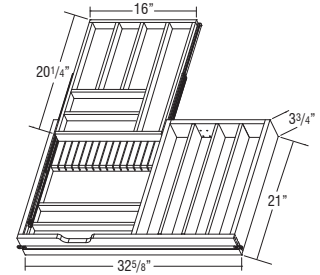
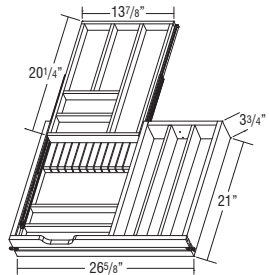
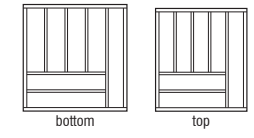
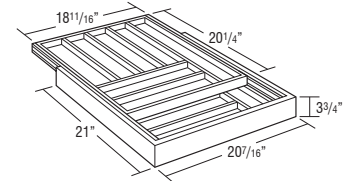
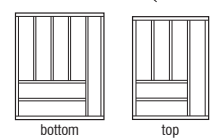
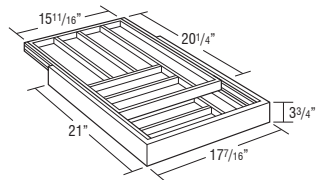
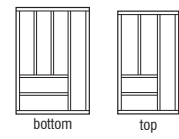
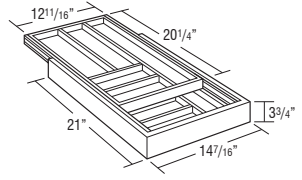
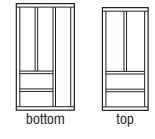
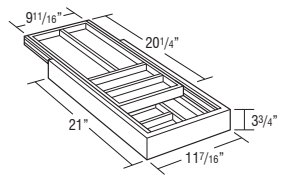

- Replaces standard drawer. Uses existing cabinet member drawer hardware.
- Requires field installation of drawer front.
- For use with 24" deep cabinets only.
- Exterior WTCD drawer box height is 3 3/4", interior height of top and bottom tier is 1 3/8".
- Top divider slides front-to-back.

Model	Application
WTCD15	15" Base
WTCD18	18" Base
WTCD21	21" Base
WTCD24	24" Base
WTCD30	30" Base
WTCD36	36" Base

DESCRIPTION	MODEL	PRICE
-------------	-------	-------

WOOD TIERED K-CUP* DRAWER	KCUP18	532
----------------------------------	---------------	------------

- Holds 40 K-Cups.
 - Exterior Wood Tiered K-Cup drawer box height is 3 3/4", interior height of top tier is 1 5/8", and interior height of bottom tier is 1 3/8".
 - The Wood Tiered K-Cup Drawer is compatible with K-Cup pods only.
 - Replaces standard drawer. Uses existing cabinet member drawer hardware.
 - Requires field installation of drawer front.
 - Only for use with 24" deep cabinets that are 18" wide or have a 15" wide frame opening for the drawer.
 - Top divider slides front-to-back.
- *K-Cup is a registered trademark of Keurig Green Mountain, Inc.

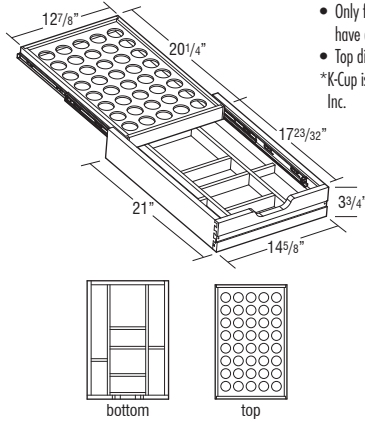

DESCRIPTION	MODEL	PRICE
-------------	-------	-------

EDGEBOARDING	EDGEBAND1OWD	44
---------------------	---------------------	-----------

EDGEBAND1OP	44
--------------------	-----------

EDGEBAND1ONML	44
----------------------	-----------

EDGEBAND1OWHL	44
----------------------	-----------

- Edgebanding will come in a 10' length. Recommended for use on panels 3/4" thick or less, edgebanding width will need to be field-trimmed.
- Finger joints may be visible on unfinished veneer and clear coated edgebanding.
- Edgebanding does not come pre-glued.
- EDGEBAND1OWD is unfinished veneer, available in Cherry, Maple, Oak, Rustic Alder, and Rustic Hickory.
- EDGEBAND1OP is available in laminate finishes.
- EDGEBAND1ONML is Natural Maple Laminate.
- EDGEBAND1OWHL is White Laminate.

DESCRIPTION	MODEL	PRICE
-------------	-------	-------

ANGLED HEAT SHIELDS	ANGLHEATSHIELD	155
----------------------------	-----------------------	------------

ANGLSHIELDSS	176
---------------------	------------

- ANGLHEATSHIELD is a pair of 1/16" thick, white powder coated metal shields.
- ANGLSHIELDSS is a pair of 1/16" thick, stainless steel metal shields.
- Heat Shield is used to deflect heat from self-cleaning ovens away from cabinet doors and drawer fronts.
- For use when additional 1/8" cannot be added to the oven manufacturer's recommended space requirement.
- Cabinet door cannot be hinged on the same side as the angled heat shield, not compatible with double door cabinets.
- Installs on the front of the face frame of each cabinet adjacent to the oven.

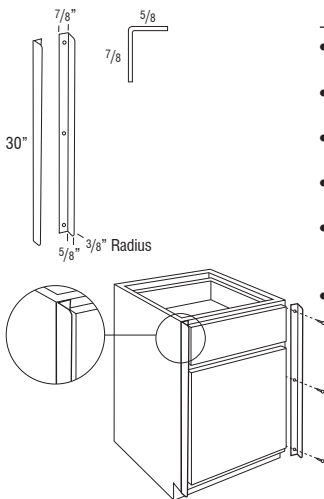

DESCRIPTION	MODEL	PRICE
-------------	-------	-------

STRAIGHT HEAT SHIELDS	STRTHEATSHIELD	114
------------------------------	-----------------------	------------



STRTHSHIELDSS	136
----------------------	------------

LO	323
-----------	------------

- STRTHEATSHIELD is a pair of 1/16" thick, white powder coated metal shields.
- STRTHSHIELDSS is a pair of 1/16" thick, stainless steel metal shields.
- Heat Shield is used to deflect heat from self-cleaning ovens away from cabinet doors and drawer fronts.
- For use when additional 1/8" can be added to the oven manufacturer's recommended space requirement.
- Installs on the side of the face frame of each cabinet adjacent to the oven.

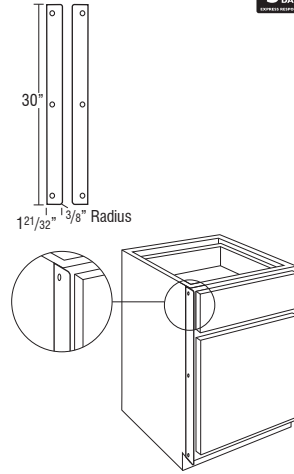

DESCRIPTION	MODEL	PRICE
-------------	-------	-------

LID ORGANIZERS	LCHAMPERLNR	115
-----------------------	--------------------	------------



LID ORGANIZERS	LO	323
-----------------------	-----------	------------

- LO is designed to be in any standard roll tray in a 24" deep cabinet.

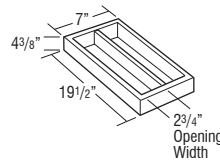

DESCRIPTION	MODEL	PRICE
-------------	-------	-------

OVEN INSTALLATION KIT	OCINSTALLKIT	62
------------------------------	---------------------	-----------



PEGGED DISH ORGANIZER	PDO (8 Pegs & Board)	396
------------------------------	---------------------------------	------------

PDOPOSTS (4 Pegs)	101
--------------------------	------------

- Replacement cloth liner for use with LCRH188421, L188421BH, VBH183421, and VH183221FH.



DESCRIPTION	MODEL	PRICE
-------------	-------	-------

OVEN INSTALLATION KIT	OCINSTALLKIT	62
------------------------------	---------------------	-----------



PEGGED DISH ORGANIZER	PDO (8 Pegs & Board)	396
------------------------------	---------------------------------	------------

PDOPOSTS (4 Pegs)	101
--------------------------	------------

- Recommended for supporting built-in appliances such as ovens, microwaves, and warming drawers. Refer to appliance manufacturer specifications for installation requirements.
- Weight limit is 400 lbs. per pair.

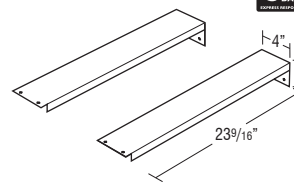

DESCRIPTION	MODEL	PRICE
-------------	-------	-------

PEGGED DISH ORGANIZER	PDO (8 Pegs & Board)	396
------------------------------	---------------------------------	------------



PDOPOSTS (4 Pegs)	101
--------------------------	------------

- Recommended for use in 36" wide Two Drawer Base (2DB) and Three Drawer Base (3DB) cabinets, trimmable for cabinets less than 36" wide. Not recommended for use in roll trays.
- Pegged Board is 19/32" thick.
- 29 15/16" x 19 1/2".
- Pegs are 6" high.

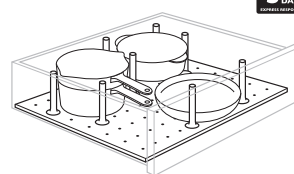

DESCRIPTION MODEL PRICE

POTS & PANS PULL-OUT



PPP 989

- For use in 24" wide cabinets.

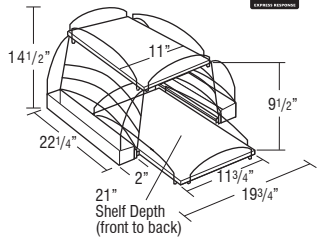

PPP30 1371

- For use in 30" wide cabinets.

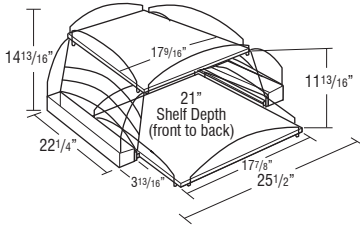

POWERGLIDE™ COMPACT DRAWER OUTLET

DRWPWR1 505

- Outlet has a total rated capacity of 15 amps.
- Includes two 120V electrical plug-ins and two 2.1 amp rated USB charging ports.
- Cord has 3 ft. of length hanging freely from back mounting bracket. The cord is 14 gauge wire and features a standard 3-prong plug and is required to be plugged into an approved AFCI/GFCI dual function outlet for all applications.
- Outlet is ETL approved-compliant for electrical and other safety standards to U.S. and Canadian safety including UL standards.
- Requires field installation including a 4.25" x 2.13" square hole to be cut into the back of the drawer box.
- Outlet face plate measures 5.22" x 2.3" and will extend 3/4" into drawer box.
- A minimum drawer box height of 2 5/8" is required for installation.
- For use in base cabinet widths of 18" to 36".
- For use in cabinet depths of 15", 18", 21", and 24".
- Also available as an installed modification, see DRWPWR on page 17.

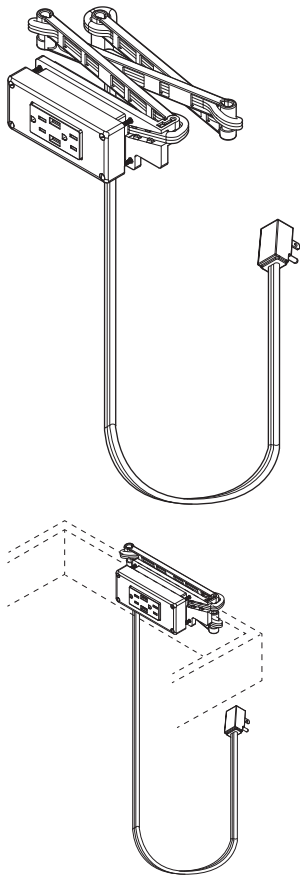

DESCRIPTION MODEL PRICE

POWER POD

JPWRPODBK (Black) 656

JPWRPODSS (Stainless Steel) 937

JPWRPODGM (Gun Metal Black) 937

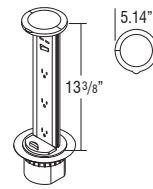

- Includes: independent power switch, three electrical sockets, and two USB ports (*located above power switch*).
- 18" of clearance required below surface mount location; and 3 9/16" diameter hole is required in countertop to install.
- This item requires field installation. This accessory cannot be installed above drawers.
- Safe for countertop installation: rated IP54-splash proof from splashing water and water jets per IPX waterproof specifications; and is ETL approved-compliant for electrical and other safety standards to North America safety including: UL, ANSI, CSA, ASTM, and NFPA standards.
- When installed, top lip of strip sits on top of countertop with a pivoting handle. Handle is pulled up to bring bottom of power strip to countertop.
- Cord is 8 ft. long and features a standard 3-prong plug for use in any household outlet. 10 amps.

SLIDING TOWEL RACK



STR 144

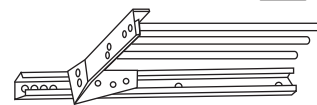

- Metal.
- 5" wide x 17 3/4" long x 1 1/2" high.
- Fits in any sink cabinet.

EZ-ORG™ MODULAR PULL-OUT RACKS



EZORG18 526

EZORG24 700

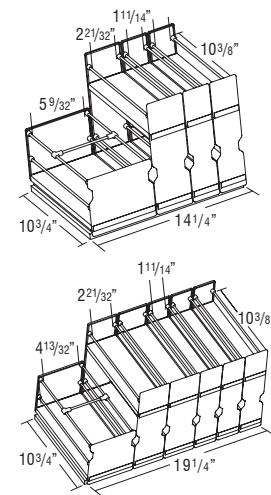

- EZORG18 includes four pull-out racks installed onto a wood base for use in an 18" wide or wider cabinet. Outside rack dimensions:
 - one 5 7/8" wide x 5 3/4" high
 - one 3 1/4" wide x 10 3/4" high
 - two 2 3/8" wide x 10 3/8" high
- EZORG24 includes six pull-out racks installed onto a wood base for use in a 24" wide or wider cabinet. Outside rack dimensions:
 - one 5" wide x 5 3/8" high
 - two 3 1/4" wide x 10 3/4" high
 - three 2 3/8" wide x 10 3/8" high
- Entire pull-out must be installed as one unit, cannot remove racks from wood base for individual installation.
- Racks feature natural finish wood shelves with wire racks and frosted front and back panels. Guides are full extension and do not feature soft-close.
- Maximum Weight Capacity:
 - 2 3/8" and 3 1/4" wide racks: 7 lbs.
 - 5" and 5 7/8" wide racks: 20 lbs.
- Must be installed on the floor of the cabinet. Cannot be installed on an adjustable shelf.
- Field installation requires attaching wood base to cabinet bottom with pre-drilled mounting holes, includes 4 screws and instructions.
- Installation height clearance of 12" minimum is recommended.

SPICE RACKS



SRCH12 127

SRCH15 142

SRCH18 155

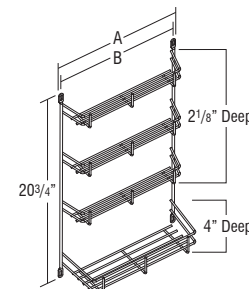

- Designed for Base cabinets only. Mounts to door top and bottom rails.
- Spice Rack is chrome.

Model	A	B	Fits
SRCH12	7 7/8"	8 13/50"	B15, B30, B33
SRCH15	10 5/8"	11"	B18, B36
SRCH18	13 5/8"	14"	B21, B24 L or R

**A = Hole Centers Width
B = Outside Overall Widths**

DESCRIPTION MODEL PRICE

SPICE RACK PULL-DOWN



SPD18 239

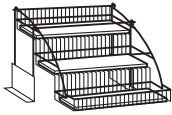

- Spice Rack Pull-down dimensions: 8 15/16" high x 14 13/16" wide x 10 5/16" deep.
- Extends 3 3/4" below and 9 1/4" in front of the cabinet box when fully extended.
- Maximum Weight Capacity: 15 lbs.
- Must be installed on the floor of the cabinet. Cannot be installed on an adjustable shelf.

SHELF PULL-DOWN



SHLFPD36 1448

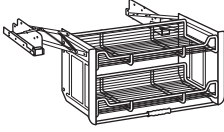

- Shelf Pull-down dimensions: 18 11/64" high x 28 1/4" wide x 8 1/2" deep.
- Clearance dimensions: 19 3/8" high x 15 3/8" wide.
- Maximum Weight Capacity: 26 lbs.
- Must be installed on the floor of the cabinet. Cannot be installed on an adjustable shelf.

TOEKICK VACUUM



TOEKICKVAC 632

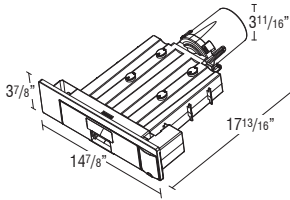

- 120V compact vacuum cleaner for field installation into the toekick area of base cabinets. Toekick area must be routed for vacuum to be inserted and screwed into place.
- Flooring installation must be compatible with the vacuum by ensuring the bottom of the cabinet is flush with the top of the flooring to allow clearance for the tray to open to access the bag and filter. The flooring should either be installed under the cabinets or the cabinets can be raised to the flooring level.
- Vacuum is 120V-60Hz, rated current of 5 amps, and rated input power is 650W.
- Cord is 10 ft. from the right side of the unit and features a standard 3-prong plug for use in any household outlet.
- Built-in switch can be gently tapped to turn the unit on and off.
- Should not be installed in a sink base, bathroom, outdoors, or in other wet environments. Do not expose to moisture, rain, or snow. Do not pick up water or sweep water into the vacuum.
- For installation in the front toekick, cabinet must have a minimum depth of 22" and a minimum width of 18". For installation in an end panel, cabinet must have a minimum depth of 21" and a minimum width of 21".
- TOEKICKVAC includes three reusable 0.5 gallon vacuum bags and one HEPA filter.
- Plastic faceplate features a stainless steel look.
- An air exhaust opening equal to 8" sq (50 cm sq) is required in an area adjacent to the TOEKICKVAC at the rear or side of the cabinet, where cabinets are tight to the floor.

TILT-OUT TRAYS, PLASTIC



TOT15 122

TOT18 128

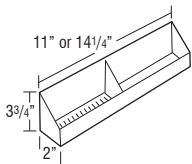

- Kit includes two white plastic trays and one pair of tilt-out hinges that attaches to the inside of the false panel.
- Tilt-out Trays are stain resistant, moisture resistant plastic to allow storage of sponges and other cleaning materials.
- One tilt-out tray per false panel on cabinets less than 30" wide and greater than 36" wide, two tilt-out trays attached to one false panel on 30"-36" wide cabinets.
- Clean using a mild soap and water. Avoid scalding water.

Model	Width	Application
TOT15	11"	SB30, SB33
TOT18	14 1/4"	SB21, SB24, SB27, SB36, SB39, SB42, SB45, SB48

DESCRIPTION MODEL PRICE

TILT-OUT TRAYS, STAINLESS STEEL SLIM



TOTSSS10 289

TOTSSS13 289

TOTSSS16 289

TOTSSS19 289

TOTSSS25 289

TOTSSS31 289

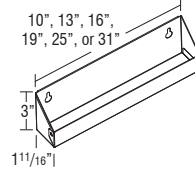

- Contains one tray and one pair of tilt-out hinges that attaches to the inside of the false panel.
- One tilt-out tray per false panel.
- Tray is 1 11/16" deep and protrudes 3/4" into cabinet.

Model	Width	Application
TOTSSS10	10"	ACS36, VSB15
TOTSSS13	13"	SB39, ACS39, VSB18, VSB39, 2VSD36, 2VSD42, 2VSD48, VSD60, 6VSD42FP
TOTSSS16	16"	SB21, SB42, SB45, VSB21, VSB42, VSB45, 2VSD45, VSD54FP, VSD60FP, VSDS54, VSDS57, VSDS60, 6VSD45
TOTSSS19	19"	SB24, SB27, SB48, ACS42, VSB24, VSB27, VSB48, VSB54, 2VSD54, 2VSD60, VSD24FP, VSD27FP, 6VSD48FP, 6VSD54FP, 6VSD57FP, 6VSD60FP, 8VSD48FP, 8VSD60FP
TOTSSS25	25"	SB30, SB33, VSB30, VSB33, VSB60, VSD30FP, VSD33FP, VSD42FP, VSD45FP, VSWD30FP
TOTSSS31	31"	SB36, VSB36, VSD36FP, VSD48FP, VSWD36FP

TRAY DIVIDER, CHROME



CTDK 60

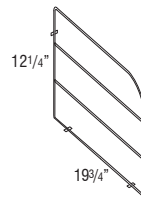

- CTDK: Includes 1 divider, 3 clips, and 3 screws.
- Tray divider is chrome wire.

TRAY DIVIDER KIT



TDKIT15 196

TDKIT18 196

TDKIT21 196

TDKIT24 196

TDKIT27 196

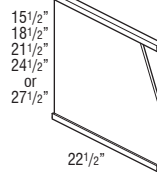

- Cabinets need full top and bottom for field installation of tray divider kits.
- Dividers are sized for a 24" deep cabinet, depth can be modified during field installation. Each kit includes two rails, one divider panel, and installation screws.
- Tray dividers are Natural Maple laminated plywood. Rails are always Natural Maple.

Model	Application	Wall Cabinets	Tall Cabinets – Upper Section
TDKIT15	Fits 15" high frame opening	Most 18" high wall cabinets	Upper section of 84" high utility, oven cabinets with 15" high frame opening
TDKIT18	Fits 18" high frame opening	Most 21" high wall cabinets	Upper section of 87" high utility, oven cabinets with 18" high frame opening
TDKIT21	Fits 21" high frame opening	Most 24" high wall cabinets	Upper section of 90" high utility, oven cabinets with 21" high frame opening
TDKIT24	Fits 24" high frame opening	Most 27" high wall cabinets	Upper section of 93" high utility, oven cabinets with 24" high frame opening
TDKIT27	Fits 27" high frame opening	Most 30" high wall cabinets	Upper section of 96" high utility, oven cabinets with 27" high frame opening

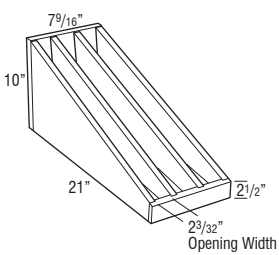
DESCRIPTION	MODEL	PRICE
TRAY DIVIDER ROLL-OUT KIT 	TDRO12	323
	TDRO15	361

- TDRO12: 2 removable dividers (3 compartments).
- TDRO15: 3 removable dividers (4 compartments).
- Utilizes soft-close undermount guides.
- Installation hardware included.

DESCRIPTION	MODEL	PRICE
VANITY CHROME ROLL-OUT RACK 	VCRR1521	254
	VCRR1821	274

- VCRR1521 requires installation to a fixed shelf or cabinet bottom in a minimum 21" deep cabinet with a minimum frame opening of 12".
- VCRR1521 installed dimensions: 19 3/4" deep x 11" wide x 5 3/4" high.
- VCRR1821 requires installation to a fixed shelf or cabinet bottom in a minimum 21" deep cabinet with a minimum frame opening of 15".
- VCRR1821 installed dimensions: 19 3/4" deep x 14" wide x 5 3/4" high.
- Roll-out rack is full extension.
- See chart for recommended cabinet list, requires sufficient field plumbing clearance.

Model	Applicable Cabinet Width	
	VCRR15	VCRR18
DDO_2921	15"	18"
L188421BH		18" (upper section)
L188421		18"
LTD188421, LTD188421BH		18"
2VSD_21	54" (side doors)	36", 60" (side doors)
6VSD_21, 6VSD_21FP		42"
V_21	15"	18"
VB_21	15", 30"	18", 36"
VSB_21	15", 30"	18", 36"
VSD_21	27"	30"
VSWD_21FP	30"	36"
VU188421		18"

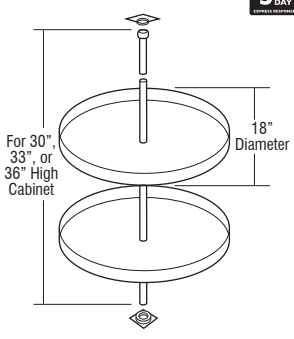
DESCRIPTION	MODEL	PRICE
WALL SUSAN KITS 	WSK30	323
	WSK33	323
	WSK36	421
	WSK39	464
	WSK42	500

- 30"-36" kits include pole and two 18" diameter plywood shelves. 39" and 42" kits include pole and three 18" diameter plywood shelves.

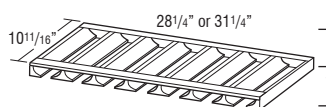
DESCRIPTION	MODEL	PRICE
WINE GLASS HOLDERS 	WGH30 (7 slots)	318
	WGH33 (7 slots)	362
	WGH36 (8 slots)	392

- Maximum wine glass base is 3" diameter.
- Wine Glass Holder is finished.
- May be trimmed to fit smaller cabinets.
- Designed for installation under a wall cabinet (between end panels and behind face frame).

Species Availability

Rustic Alder	Cherry	Rustic Hickory	Laminate	Maple	Oak
	•	Hickory	box color	•	•

DESCRIPTION

MODEL

PRICE

ROLL TRAY KITS

ROLL TRAY KIT

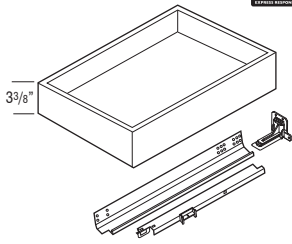

RT12SC	409
RT15SC	409
RT18SC	411
RT21SC	426
RT24SC	428
RT27SC	442
RT30SC	451
RT33SC	459
RT36SC	464
RT39SC	411
RT45SC	426

- RT_ _SC's include roll tray, roll tray brackets, hardware, screws, and installation instructions.
- All kits will contain 1 roll tray. For 39"-45" cabinets, you must order QTY of 2 to achieve a roll tray in both cabinet openings.
- Exterior dimensions of roll tray are 21" deep x 3 3/8" tall (fits standard 24" deep cabinet).

Custom Modifications

CW	ID	RD
• ¹		•

¹Not available on RT12SC

Model	Roll Tray Width	Application
RT12SC	7 3/4"	B12, U12
RT15SC	10 3/4"	B15, U15
RT18SC	13 3/4"	B18, U18
RT21SC	16 3/4"	B21, B42, U21
RT24SC	19 3/4"	B24, B48, U24
RT27SC	22 3/4"	B27, U27
RT30SC	25 3/4"	B30, U30
RT33SC	28 3/4"	B33, U33
RT36SC	31 3/4"	B36, U36
RT39SC	15 1/4"	B39
RT45SC	18 1/4"	B45

DEEP ROLL TRAY KIT

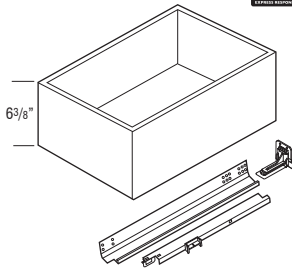

DRT12	448
DRT15	448
DRT18	449
DRT21	460
DRT24	464
DRT27	478
DRT30	487
DRT33	496
DRT36	501
DRT39	449
DRT45	460

- DRT_ _'s include deep roll tray, deep roll tray brackets, hardware, screws, and installation instructions.
- All kits will contain 1 roll tray. For 39"-45" cabinets, you must order QTY of 2 to achieve a roll tray in both cabinet openings.
- Exterior dimensions of roll tray are 21" deep x 6 3/8" tall (fits standard 24" deep cabinet).

Custom Modifications

CW	ID	RD
• ¹		•

¹Not available on DRT12

Model	Roll Tray Width	Application
DRT12	7 3/4"	B12, U12
DRT15	10 3/4"	B15, U15
DRT18	13 3/4"	B18, U18
DRT21	16 3/4"	B21, B42, U21
DRT24	19 3/4"	B24, B48, U24
DRT27	22 3/4"	B27, U27
DRT30	25 3/4"	B30, U30
DRT33	28 3/4"	B33, U33
DRT36	31 3/4"	B36, U36
DRT39	15 1/4"	B39
DRT45	18 1/4"	B45

DESCRIPTION

MODEL

PRICE

ROLL TRAY KIT – EASYTRAX™

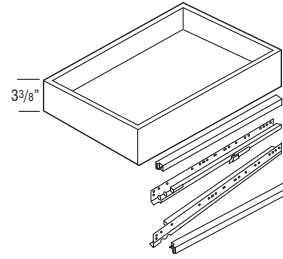

RT15ET	409
RT18ET	411
RT21ET	426
RT24ET	428
RT27ET	442
RT30ET	451
RT33ET	459
RT36ET	464
RT39ET	411
RT45ET	426

Model	Roll Tray Width	Application
RT15ET	10 3/4"	B15, U15
RT18ET	13 3/4"	B18, U18
RT21ET	16 3/4"	B21, B42, U21
RT24ET	19 3/4"	B24, B48, U24
RT27ET	22 3/4"	B27, U27
RT30ET	25 3/4"	B30, U30
RT33ET	28 3/4"	B33, U33
RT36ET	31 3/4"	B36, U36
RT39ET	15 1/4"	B39
RT45ET	18 1/4"	B45

- EasyTrax™ system allows quick field installation of adjustable height roll trays with front and rear uprights to support roll tray guides.
- EasyTrax™ uprights are required, must be purchased separately (see page 318).
- RT_ _ET's contain roll tray, hardware, wooden hardware mounting bracket, screws and installation instructions.
- All kits will contain 1 roll tray. For 39"-45" cabinets, you must order QTY of 2 to achieve a roll tray in both cabinet openings.
- Exterior dimensions of roll tray are 21" deep x 3 3/8" tall (fits standard 24" deep cabinet).

Custom Modifications

CW	ID	RD
•		•

DEEP ROLL TRAY KIT – EASYTRAX™

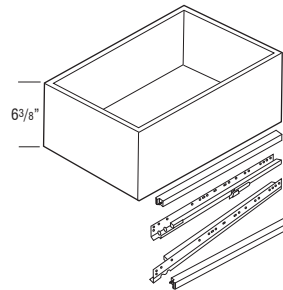

DRT12ET	448
DRT15ET	448
DRT18ET	449
DRT21ET	460
DRT24ET	464
DRT27ET	478
DRT30ET	487
DRT33ET	496
DRT36ET	501
DRT39ET	449
DRT45ET	460

- EasyTrax™ system allows quick field installation of adjustable height roll trays with front and rear uprights to support roll tray guides.
- EasyTrax™ uprights are required, must be purchased separately (see page 318).
- DRT_ _ET's contain roll tray, hardware, wooden hardware mounting bracket, screws and installation instructions.
- All kits will contain 1 roll tray. For 39"-45" cabinets, you must order QTY of 2 to achieve a roll tray in both cabinet openings.
- Exterior dimensions of roll tray are 21" deep x 6 3/8" tall (fits standard 24" deep cabinet).

Custom Modifications

CW	ID	RD
• ¹		•

¹Not available on DRT12ET

Model	Roll Tray Width	Application
DRT12ET	7 3/4"	B12, U12
DRT15ET	10 3/4"	B15, U15
DRT18ET	13 3/4"	B18, U18
DRT21ET	16 3/4"	B21, B42, U21
DRT24ET	19 3/4"	B24, B48, U24
DRT27ET	22 3/4"	B27, U27
DRT30ET	25 3/4"	B30, U30
DRT33ET	28 3/4"	B33, U33
DRT36ET	31 3/4"	B36, U36
DRT39ET	15 1/4"	B39
DRT45ET	18 1/4"	B45

DESCRIPTION MODEL PRICE

EASYTRAX™ UPRIGHTS



ETUPRIGHT	192
ETUPRIGHTOV	187
ETUPRIGHT40.5	218
ETUPRCS	10
ETUPR40.5CS	10

- EasyTrax™ system allows quick field installation of adjustable height roll trays with front and rear uprights to support roll tray guides.
- ETUPRIGHT contains 2 front and 2 rear uprights.
QTY required: Base, Base Full Height, and 34 1/2" high Vanities = 1
Utility Cabinets = 3
42" and 48" wide cabinets = 2.
- ETUPRIGHTOV contains 2 front and 2 rear uprights.
QTY required: Desk and 32" high Vanity = 1.
- ETUPRIGHT40.5 contains 2 front and 2 rear uprights.
QTY required: 40 1/2" high Base cabinets = 1.
- ETUPRCS and ETUPR40.5CS recommended for DRT39ET-DRT45ET and RT39ET-RT45ET kits to secure drawer guide in ET system on cabinets with center stiles.

ETUPRIGHT

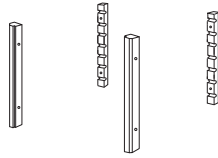

ETUPRIGHTOV

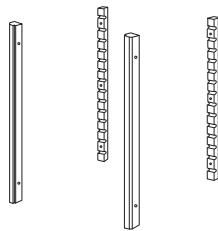

ETUPRIGHT40.5



**ETUPRCS
ETUPR40.5CS**

DESCRIPTION MODEL PRICE

STAIN, PAINT, & TOUCH-UP TOOLS

STAIN & PAINT



QUARTCOLOR	179
SSC	65
SSCCLEAR	65
SSCMATTESH	65

- Wiping stains can be sprayed at low pressure.
- Specify finish name and wood type when ordering.
- QUARTCOLOR sold in quarts.
- SSC is a 384 mL aerosol can available in Paint colors.
- SSCCLEAR is a 384 mL aerosol can in clear.
- SSCMATTESH is a 384 mL aerosol can in clear with a matte sheen.
- QUARTCOLOR and SSC will match the cabinet box color when ordered in laminate finishes.
- For Touch-up Kits and Glaze Pens, see below.

TOUCH-UP TOOLS



TUK	93
MTUK	47
GLAZEPEN	54

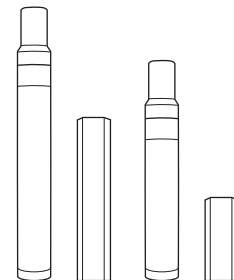

TUK MTUK

- Touch-up Kit includes a full size touch-up marker and a full size fill stick. No glaze pen included with glaze finishes.
- Mini Touch-up Kit includes a small touch-up marker and a small fill stick. No glaze pen included with glaze finishes.
- GLAZEPEN available in glaze colors only.
- GLAZEPEN works on finished doors and does not require a separate top coat.
- TUK and MTUK will match the cabinet box color when ordered in laminate finishes.

CABINET CARE KIT (PURE&SIMPLE™)



CABCLEANKIT 53

- PURE&SIMPLE™ Cabinet Care Kit includes one 16 ounce spray bottle of cleaning solution and a small microfiber cloth.
- Safe for use on wood and laminate cabinet surfaces.



DESCRIPTION	MODEL	PRICE
-------------	-------	-------

GUIDE KITS AND PARTS

DRAWER GUIDE KITS



DGK21HD	389
DGK24HD	389

- Undermount full extension Heavy Duty soft-close Premium Guide.
- Maximum Weight Capacity: 90 lbs. per pair.
- Kit includes guide hardware for one drawer box (cabinets and drawer members, sockets and screws).
- Dimension refers to cabinet depth.
- Guides are used on bottom drawers in VWH2D __, 3DBDD __, 3DBBDD __, and both drawers on 42" and 48" wide 2DB __.

DGK21DDFX	296
DGK24DDFX	296

- Side-mount progressive full extension guide utilized on all drawers of DDFD __ cabinets.
- Maximum Weight Capacity: 125 lbs. per pair.
- Kit includes guide hardware for one drawer box (cabinets and drawer members, mounting rails, and screws).
- Dimension refers to cabinet depth.

DGKIT12SC	259
DGKIT15SC	259
DGKIT18SC	259
DGKIT21SC	259
DGKIT24SC	259

- Undermount full extension soft-close Premium Guide.
- Maximum Weight Capacity: 75 lbs. per pair.
- Kit includes guide hardware for one drawer box (cabinets and drawer members, sockets and screws).
- Dimension refers to cabinet depth.

DGKIT12RTSC	259
DGKIT15RTSC	259
DGKIT18RTSC	259
DGKIT21RTSC	259
DGKIT24RTSC	259

- Undermount full extension soft-close Premium Guide utilized on roll trays.
- Maximum Weight Capacity: 75 lbs. per pair.
- Kit includes guide hardware for one roll tray (cabinets and drawer members, sockets and screws).
- Dimension refers to cabinet depth.

DRAWER GUIDE BACK SOCKETS



BKSOCKET-SCSPC	48
BKSOCKET-SC	48
BKSOCKET-RTSC	48

- BKSOCKET-SCSPC used with soft-close drawer guides and roll tray guides (12" deep).
- BKSOCKET-SC used with soft-close drawer guides and HD guides (15"-24" deep).
- BKSOCKET-RTSC used with soft-close roll tray guides (15"-24" deep).
- Sold in pairs.

DESCRIPTION	MODEL	PRICE
-------------	-------	-------

DRAWER GUIDE BOX LOCKS



DGBOXLOCKSPC	44
DGBOXLOCKB9SPC	44
DGBOXLOCKSC	44
DGBOXLOCKSCB9	44

- DGBOXLOCKSPC used with soft-close drawer guides (12" deep) and HD guides.
- DGBOXLOCKB9SPC used with soft-close drawer guides on cabinets with drawers with a face frame opening of 7 1/2" or less (12" deep).
- DGBOXLOCKSC used with soft-close drawer guides (15"-24" deep).
- DGBOXLOCKSCB9 used with soft-close drawer guides on cabinets with drawers with a face frame opening of 7 1/2" or less (15"-24" deep).
- Sold in pairs.

DRAWER GUIDE SPACER BLOCK

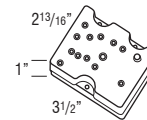

SPACERBLK	29
------------------	-----------

- Sold in pairs.
- For use with DGKIT..SC and DGKIT..RTSC kits when RD is used for depths other than in 3" increments.
- One SPACERBLK required for each inch of depth.
- Not required for use with 23", 20", 17", 14" depth.

FALSE PANEL CLIPS

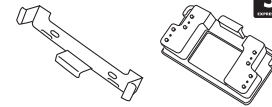

FALSEPNLCLIP50	9
PFALSEPNLCLIP50	9

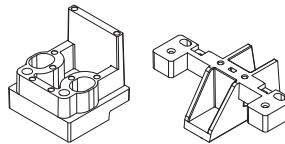

- Use to secure false front on sink base.
- Sold in pairs.

ROLL TRAY PLUG IN BRACKET



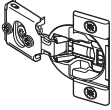
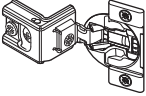
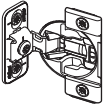
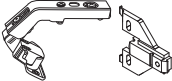

RTBKXSXP	49
-----------------	-----------

- For use with roll tray hardware to prevent interference with door hinges. Also included in roll tray hardware kit.
- Includes four end panel brackets, two vertical stile brackets, and screws.

DESCRIPTION	MODEL	PRICE
HINGES		
HINGES		
	38NPOHINGE	31
	<ul style="list-style-type: none"> • Integrated soft-close. • 6-way adjustable. • 1/2" partial overlay 107° hinge. • For use on all partial overlay cabinets not specified by other hinges. • For use on Base Transition Cabinets (BTC), Diagonal Wall (DW) and Diagonal Base (DAB) Cabinets, 36" Angled Corner Sink Bases (ACS) & Fronts (ACSF), and Wall Top Hinge (WTH) Cabinets with Modified Full Overlay (MFO). • Sold in pairs. 	
	38CFOHINGE	31
	<ul style="list-style-type: none"> • Integrated soft-close. • 6-way adjustable. • 107° full overlay hinge. • For use on all full overlay cabinets not specified by other hinges. • Sold in pairs. 	
	38BFOVHINGE	31
	<ul style="list-style-type: none"> • Integrated soft-close. • 4-way adjustable. • Face-mount 107° full overlay hinge. • For use on oven cabinets with 3" wide face frames (OCD, OCS, OMC, OS3D, OSB, T3DMW, and TBMWB), and 36"-42" high WBMW cabinets. • Sold in pairs. 	
	32049HINGE	83
	<ul style="list-style-type: none"> • 90° Corner Self-Closing Center Hinge. • For use on ER, BLS, SLS, BER, BERAS, and CS cabinets. • Sold in pairs. 	
	942HINGE	71
	<ul style="list-style-type: none"> • 170° Hinge • For use on BSC, BLS, SLS, BER, BERAS, CS, and ER cabinets. • Sold in pairs. 	
	7299HINGE	13
	<ul style="list-style-type: none"> • Mirror Hinge • For use on TV and MC cabinets. • Sold in pairs. 	

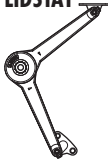
HINGE ANGLE RESTRICTION CLIP		
	HINGERESCLIP	13
	<ul style="list-style-type: none"> • For use in applications with cabinets installed at varying depths to prevent the door damage caused by opening into an adjacent cabinet. • Restricts hinges to 86° opening capability. • Works only with the 38NPOHINGE and 38CFOHINGE. • Not recommended for cabinets with roll trays specified in partial overlay styles. • Sold in pairs. 	

DESCRIPTION	MODEL	PRICE
HINGE SHIM	HINGESHIMS	18
		
	<ul style="list-style-type: none"> • Install between the face frame and hinge to allow additional adjustment of doors. Can be used to reduce gap between butt doors. • Each shim is 1/32" thick and can be stacked to achieve desired overlay reduction. • Pack of 5 metal shims. • Compatible with all hinges except face-mount. 	
LIDSTAY	LIDSTAY	233
		
	<ul style="list-style-type: none"> • Sold in pairs. • Recommended for field installed wall top hinge applications 12" to 18" high. 	
LIDSTAY - HEAVY DUTY	LIDSTAYHD	214
		
	<ul style="list-style-type: none"> • One heavy duty lid stay hinge required per cabinet. • Recommended for field installed wall top hinge applications of 21" high cabinets. 	
WALL TOP HINGE ANGLE RESTRICTION CLIPS	WTHRESCLIP75	13
		
	<ul style="list-style-type: none"> • For use on 9" high Wall Top Hinge cabinets only. • Restricts opening angle of the door to 75°. • Prevents the door from hitting the ceiling or an object above, also keeps the handle within reach on very high cabinets. • Sold in pairs (two clips required per cabinet). 	

DESCRIPTION	MODEL	PRICE
-------------	-------	-------

DOORS, DRAWER FRONTS, & DRAWERS		
DOORS & DRAWER FRONTS	 Standard Door Size, 18" High or Less	319 ea.
	Standard Door Size, 21" to 30" High	395 ea.
	Standard Door Size, 33" or Higher	559 ea.
	Standard Door Size, No Hinge Route, 18" High or Less	319 ea.
	Standard Door Size, No Hinge Route, 21" to 30" High	395 ea.
	Standard Door Size, No Hinge Route, 33" or Higher	559 ea.
Any Drawer Front Only		141 ea.

- Door heights are based on full overlay for equivalent applications.
- All applicable modification and premium finish upcharges will apply.
- Backs of "NO HINGE ROUTE" doors may have identification marks, be unfinished, and have 3/16" diameter holes used during finish processing. For these reasons, these doors are not suitable for use as cabinet doors.

DRAWERS



Complete Drawer	228 ea.
Drawer Box Only	203 ea.

- All applicable modification and premium finish upcharges will apply.
- Complete Drawer and Drawer Box Only do not include drawer guides. They must be ordered separately.

DESCRIPTION	MODEL	PRICE
-------------	-------	-------

MISCELLANEOUS PARTS		
MISCELLANEOUS PARTS	 BRKOFFSCREW (pkg. 25)	6
	BUMPERPADS (pkg. 25)	8
	INSTALLSCR4 (pkg. 4)	5
	INSTALLSCREWS (pkg. 100)	20
	PDM	37
	RETCLIP250BAG	19
	SHELFPEGS (pkg. 24)	11

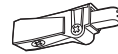

PDM

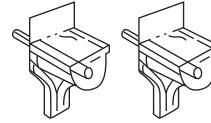

SHELFPEGS

- BRKOFFSCREW is a pack of 25 breakaway screws for use with decorative hardware pulls and knobs.
- INSTALLSCR4 and INSTALLSCREWS are screws for cabinet installation through the cabinet back to the wall studs (includes a pack of 4 or 100).
- PDM creates a smooth and silent self-closing motion and includes all installation hardware.
- RETCLIP250BAG: 6 retainer clips for use with glass inserts in mullion and cut-for-glass doors.
- SHELFPEGS are 3mm steel pins with clear plastic shoulders.

Description	Code	Page Number
Add Toekick	ADDTK	19
All-plywood Construction	APC	3
Aluminum Frame Doors w/Frost Glass	ALF	24
Angled Corner Sink Front Bottoms	ACSF	135
Angled Corner Sink Fronts	ACSF	135
Angled Corner Sinks	ACS	134
Angled Fluted/Plain Fillers	BLVDF	260
Apothecary Drawer Horizontal	ADH	100
Appliance Cut-out, Single	ACS	13
Arch Flat Panel Wood Hood	WHAFP	103
Arched Valance	AV	293
Art Corbel 9"	CORBELART9	300
Artisan Straight Wood Hood	WHAS	102
Arts & Crafts Bracket	JBRACKETART	302
Asymmetrical Base Easy Reach	BER	146
Asymmetrical Base Easy Reach w/Adjustable Shelves	BERAS	146
Asymmetrical Easy Reach Wall Corners	ER	89
Asymmetrical Solid-wood Super Lazy Susan	SLSW	149
Asymmetrical Super Lazy Susan w/Chrome Rail	SLSR	149
Asymmetrical Super Susans	SLS	148
Authentic Ends	AUTHB, AUTHL, AUTHR	7
Back Panel Moulding	BPM	287
Back Skin, Interior	BP	264
Base Apothecary Drawer	BAD	162
Base Box Column Pull-outs (Plain, Overlay)	BBCPO	164
Base Buffet Three Drawer	3DBB	156
Base Buffet Three Drawer w/Deep Drawer	3DBBDD	157
Base Built-in Microwave Cabinet w/Drawer	BBMWD	167
Base Cabinets	B	113
Base Cabinets Four Drawer	4DB	158
Base Cabinets Four Drawer w/Wood Tiered Cutlery Divider Drawer	4DB..WTCD	158
Base Cabinets Full Width w/Roll Trays & Swing-outs	BCFW.SP	143
Base Cabinets Three Drawer	3DB	155
Base Cabinets Three Drawer Corner	3CDB	151
Base Cabinets Three Drawer w/Deep Drawer	3DBDD	157
Base Cabinets Three Drawer w/Wood Tiered Cutlery Divider Drawer	3DB..WTCD	156
Base Cabinets Two Drawer	2DB	153
Base Cabinets Two Drawer w/Drop-in Range	2DB..DR	155
Base Cabinets Two Drawer w/File Drawer	2DB..FD	153
Base Cabinets Two Drawer w/Pegged Dish Organizer	2DB..PDO	154
Base Cabinets Two Drawer w/Roll Tray	2DB..RT	154
Base Cabinets Two Drawer w/Roll Tray & Pegged Dish Organizer	2DB..RTPDO	154
Base Cabinets w/Full Height Doors	B..FH	115, 116
Base Cabinets w/Mixer Shelf	B..FHMIXSC	127
Base Container Organizer Pantry Pull-out	BCOPP	163
Base Corner Cabinets	BC	140
Base Corner Cabinets w/Pull-out	BC..PO	141
Base Corner Full Width Cabinets	BCFW	141
Base Corner Full Width Cabinets w/Curved Pull-out	BCFW..CPO	142
Base Corner Full Width Cabinets w/Pull-out	BCFW..PO	142
Base Corner Full Width, Full Height	BCFW..FH	142
Base Corner Inside	B..CIA	152
Base Corner Outside	B..COA	152
Base Corner Peninsula	B..CP	168
Base Corner Peninsula, Full Height Door	B..CP..FH	168
Base Drawer Cabinets	DB	153-158
Base Drop-in Range Cabinet	B..DR	165
Base Easy Reach	BER	145
Base Easy Reach w/Adjustable Shelves	BERAS	145
Base End Cabinet	BEC	153
Base End Shelves	BQRES	169
Base Full Height w/Tray Divider	TD..FH	127
Base Lazy Susan Corner w/Center Hinge Door	BLS	143
Base Message Center	BMC	165

Description	Code	Page Number
Base Microwave Cabinets w/Deep Drawer	BMWD..DD	167
Base Microwave Cabinets w/Drawer	BMWD	167
Base Mixer Kit	MIXKITFHSC	311
Base Open Cabinets	BOC	169
Base Ovens	BO	166
Base Pan Storage	BPS	311
Base Panel w/Filler Attached & Authentic End	BEP.AEL, AER	270
Base Pantry Pull-outs	BPP	162
Base Paper Towel Cabinet w/Wastebasket	BPT..WB	159
Base Paper Towel Cabinet w/Wastebasket Full Height	BPT..WBFH	161
Base Pots & Pans Pull-out	BPPP	123
Base Rotating Deep Bin	BRDB	150
Base Transition Cabinets	BTC	151
Base Tray Divider Pantry Pull-out	BTDP	163
Base Utensil Pantry Pull-out	BUPP	163
Base Utensil Pantry Pull-out w/Knife Block	BUPPKB	164
Base Wastebasket	BWB	159
Base Wastebasket Full Height	BWB..FH	160
Base Wastebasket Lids	BWBFHLID, BWBLID	311
Base Wine Cubby	BWC	161
Base w/Can and Wine Bottle Pull-outs	B..CWP	125
Base w/Food Storage Container Organizer	B..FSCO	124
Baseboard - Furniture	BBMFB	290
Baseboard Moulding	BBM	290
Baseboard - Sculpted	BBMSC	290
Baseboard - Shaker	BBMSH	290
Baseboard - Swooped	BBMSW	290
Bases w/Roll Trays	B..RT	120
Bases w/Roll-out Tray Divider	B..TDRO	126
Bases w/Tray Dividers	TD	126
Bases w/Wood Tiered Cutlery Divider Drawer	B..WTCD	114
Bases w/Wood Tiered Cutlery Divider Drawer & Roll Trays	B..RTWTCD	122
Batten	BATTEN	287
Bauhaus Corbel	CORBELBAU	303
Biometric Secured Drawer	DRWSEC	15
Bookcases Tall	TBC	216-217
Bookcases Tall w/Doors	TBCD	218-219
Bookcases Wall Furniture	WFBC	214
Box Column Fillers (Wall, Base, Tall)	BCF	260-262
Broom Clip	BRMCLP	311
Bumper Pads	BUMPERPADS	321
Bungalow Leg	BUNLEG	294
Cabinet Box Only	CBO	9
Cabinet Care Kit (PURE&SIMPLE™)	CABCLEANKIT	318
Cabinet Case Only	CCO	9
Cabinet False Panel	CFP	9
Cabinet Frame Only	CFRMO	23
Cabinet Front Only	CFNTO	23
Cabinet Panel Edge Moulding	CPE	287
Cabinet Panel Edge Square Moulding	CPES	291
Cabinet w/No Door, w/Drawer	CND	9
CabMat™	CABMAT	311
CabMat™	CMAT	15
CabMat™ Vanity	CABMATV	311
Canopy Arch Wood Hood	JWHCA, WHCA	107
Canopy Square Wood Hood	JWHCS, WHCS	108
Cap Moulding	CAPM	291
Classic Arch Wood Hood	WHA	101
Classic Revival Corbel	CORBELCR	301
Classic Square Wood Hood	WHS	103
Classic Tall Crown Moulding	CLTCROWN	284
Classic Wood Hood Chimney	WHC	104
Contemporary Light Rail	JINSERTLRC	292
Cooking Utensil Divider	CUDD	312
Corner Door Cabinets	CD	95
Corner Fillers	CF	255

Description	Code	Page Number
Cornice Tall Crown Moulding	COTCROWN	284
Cosmo Corbel, 13" Large Deep	JCORBELCOS13D	301
Cosmo Foot	JCOSFOOT	299
Cosmo Leg	JCOSMOLEG	295
Countertop Edge Moulding (Contemporary & Traditional)	CCM, TCM	287
Country Sink Base w/CabMat™	CNTYSB..CM	136
Country Sink Base w/Short Apron	CNTYSB..SA	138
Country Sink Bases	CNTYSB	136
Cove Corbel	CORBELCOVE	301
Cove Crown Moulding	COVECROWN	284
Craftsman Foot	JCRAFTFOOT	299
Craftsman Open Bracket	JCORBELCRAFTO	302
Craftsman Straight Wood Hood	WHCFS	102
Cross Grain Veneer Back Skin 1/4" Panels	BP..CRSGR	264
Custom Doors, No Hinge Routing	DADOOR	275
Custom Doors w/Hinge Routing	DOOR	277
Custom Doors w/Hinge Routing, Slab Styles	DOORSLAB	278
Custom Drawer Fronts	DA5PCDF, DASLBDF	276
Custom Height	CH	10
Custom Island Panels	ISLBPNL	274
Custom Width	CW	10
Cut-for-glass Doors	CG, CG.BTM, CG.TOP	25
Cutlery Dividers	CIW, WTC	312
Decorative Appliance Panels	DAPNL	274
Decorative Door Panel Kits, Base End	BED	272
Decorative Door Panel Kits, Tall End	TED	272
Decorative Door Panel Kits, Wall End	WED	272
Deep Roll Tray	DRT	16
Desk Door Drawer Bases	DDO	220
Desk Double File Drawer Bases	DDFD	222
Desk Easy Reach	DER	222
Desk File Drawer Bases	DFD	221
Desk Three Drawer Bases	3DB	221
Diagonal Base Cabinet w/Full Height Door	DAB..FS	144
Diagonal Base Cabinet w/Full Height Door & Super Lazy Susan	DAB..SLS	144
Diagonal Corner Moulding	DCM	292
Diagonal Wall Cabinets	DW	83-84
Diagonal Wall Cabinets w/Lazy Susan	DW..S	85
Diagonal Wall Cabinets w/Lower Door	DW..D	85
Door Panel - Solid Reverse Raised	DPSRR	6
Drawer Front Flat 5-piece	DF5PC	4
Drawer Front Flat 5-piece Narrow Rails	DF5PCNR	4
Drawer Front Flat 5-piece Narrow Rails w/Slab Top	DF5PCNRST	5
Drawer Front Flat 5-piece w/Slab Top	DF5PCSLBT	5
Drawer Front Slab	DFSLB	4
Drawer Front Slab Top	DFSLBT	5
Drawer Guide Back Sockets	BKSOCKET	319
Drawer Guide Box Locks	DGBOXLOCK	319
Drawer Guide Kits	DGK	319
Drawer Guide Spacer Block	SPACERBLK	319
Ductwork Conversion Kit	CONVERSION	110
Easy Reach Wall Corner Cabinets	ER	88
EasyTrax™	ET	16
Edgebanding	EDGEBAND	313
End Extended Back	EXBKL, EXBKR	12
End Panel/Base	BEP	266
End Panel/Base Lazy Susan	BLSBEP	266
End Panel/Tall	TEP	266
End Panel/Vanity Base	VBEP	267
End Panel Skins/Base	BEPS	263
End Panel Skins/Tall	TEPS	263
End Panel Skins/Wall	WEPS	263
English Country Leg	JENGCNTYLEG	295
English Island Column	ENGISLCOLUMN	295
Estate Leg	JESTATELEG	295
Estate Leg, Small	JESTATELEGS	295

Description	Code	Page Number
Estate Leg Split, Small	JESTATELEGS	295
Extended Stile	EXL, EXR	13
Exterior Shelves	ES	305
EZ-Org™ Modular Pull-out Racks	EZORG	314
Face Frame and Door on End	FFDL, FFDR	7
False Panel Clips	FALSEPNLCLIP50, PFALSEPNLCLIP50	319
Filler Return	F..R	255
Fillers	F, TF	255
Finished Back Skins	BP	264
Finished Ends	FB	7
Flat Scribe Moulding	SM	288
Floating Shelves	FS	305
Flush Toekick	FTK, FTK.FNT.P, FTK.P	19
Flush Toekick Arch	FTKAV, FTKAV.FNT.P, FTKAV.P	20
Flush Toekick Furniture	FTKFV, FTKFV.FNT.P, FTKFV.P	20
Full Depth Interior Shelves	SK	306
Full Depth Shelf	FD	15
Full Height Rangenotop Base	RTBFH	166
Full Overlay Crown	FOLCROWN	284
Furniture Base Light Rail	FBLR	291
Furniture Drawer Window Bench	FDWB	223
Furniture Drawers	FD	222
Furniture Finished Plywood Ends	FPEB	7
Furniture Valance	FV	293
Gaelic Leg	GAEELICLEG	296
Glass Shelf Kits	JGSK	306
Hardware - Decorative Knobs & Pulls	KNOB, PULL	307-310
Hearth Liner	HL	111
Hearth Mantels	HM	111
Hearth Piers	HP..21	111
Hearth Shelf	HS	111
Heat Shields, Angled	ANGLHEATSHIELD, ANGLHSIELDSS	313
Heat Shields, Straight	STRTHEATSHIELD, STRTHSHIELDSS	313
Hinge Angle Restriction Clip	HINGERESCLIP	320
Hinge Shim	HINGESHIM	320
Hinges	HINGE	320
Increased Depth	ID	11
Industrial Bracket, Loop	BRACKETIND	304
Industrial Bracket, Straight	STRBRACKETIND	304
Insert Crown	INSCROWN	284
Inside Corner Moulding	ICM	292
Installed Roll Tray	RT	16
Inverted Frame	INVFRM	14
Island Leg	ISLLEG	296
Island Leg Tapered	ISLEGTPRD	296
Kensington Bun Foot	JCRBUNFOOT	299
Large Corbel	LGCORBEL	300
Large Outside Corner Moulding	LOSC	292
Large Shaker Crown	LSHAKER	285
Large Square Foot	LGSQFOOT	299
Large Straight Angle Crown Moulding	LSACROWN	284
Lazy Susan Pull-out	LSP	150
Library Moulding	LBRM	288
Lid Organizers	LO	313
Lidstay	LIDSTAY, LIDSTAYHD	320
Light Baffle Moulding	LB	291
Light Rail Cap	SOFFITA	291
Light Rail Cap - Shaker	SOFFITE	291
Light Rail Moulding	LRM	291
Lille Foot	LIFOOT	300
Linear Tapered Wood Hood	JWHL	104
Linen Closet Hamper Liner	LCHAMPERLNR	313

Description	Code	Page Number
Linen Closet w/Removable Hamper	LCRH	248
Linen Tall	LT	248
Linen Tall w/Drawer	LTD	249
Linen Tall w/Drawer and Removable Hamper	L	249
Loose Toekick	TKP	21
Madeline Foot	JMADEFOOT	299
Matching Interior Plywood	MIP	8
Medicine Cabinets (Single & Tri-View)	MC, TV	253
Medium Straight Angle Crown Moulding	MSACROWN	285
Metal Foot	FOOTMETAL	304
Metro Bar Column	METBARCOLUMN	296
Metro Island Column	METISLCOLUMN	296
Metropolitan Foot	JMETROFOOT	299
Mirror Frame Moulding	WMF	288
Miscellaneous Parts	BRKOFFSCREW, BUMPERPADS, INSTALLSCR, INSTALLSCREWS, PDM, RETCLIP.BAG, SHELFPEGS	321
Mission Corbel 6"	CORBELMIS6	301
Mission Corbel 9"	CORBELMIS9	301
Mission Leg	DLEMISSION	297
Modern Corner Floating Shelf	MDFLCRNSHLF	305
Modern Corner Shelf	MDCCRNSHLF	305
Modified Full Overlay	MFO	6
Mullion Doors	MD, MD.BTM, MD.TOP	26
Mullion Doors, Prairie	PRMD	28
Mullion Doors, Shaker	SHMD	27
Ogee Edge Moulding	OGEEM	288
Old World Corbel 5"	CORBELWD5	301
Outside Corner 135° Moulding	OC135	293
Outside Corner Moulding	OCM	292
Oven Cabinets Double	OCD	197-199
Oven Cabinets Double w/Deep Drawer	OCD.DD	200-202
Oven Cabinets Single	OSB	191-192
Oven Cabinets Single, Three Drawer Base	OS3D	193-194
Oven Installation Kit	OCINSTALLKIT	313
Oven Microwave Cabinets	OMC	207-208
Oven Microwave Cabinets w/Deep Drawer	OMC.DD	209-210
Oven Microwave Combo Cabinets w/Deep Drawer	OCS.DD	195-196
Overlay Fillers	OL	256
Overlay Fillers for Modified Full Overlay	OL.MFO	257
Palladian Foot	JPALLAFOOT	299
Palladian Island Leg	JPALLALEGT	297
Panels w/Filler Attached	BEPE, TEP, WEP	268-271
Pantry Top Units	PTU	187
Pantry Top Units w/Shelves	PTUS	186
Pantry Units	PY	189
Pantry Walk-Through	PWT	190
Pegged Dish Organizer	PDO, PDOPOSTS	313
Peninsula	P	23
Plywood Ends	PE	3
Pots & Pans Organizer Bases w/Drawer	B..PS	123
Pots & Pans Pull-out	PPP	314
Power Pods	JPWRPOD	314
PowerGlide™ Compact Drawer Outlet	DRWPWR	17, 314
Prepare Cabinet for Finished Bottom	PFINBTMB	12
Push to Open Wastebasket	PTOWB	17
Quarter Round Moulding	QRM	293
Raised Panel Arch Valance	JRPV	293
Recessed Island Toekick	RECTKALL	21
Recessed Panel Arch Valance	JRCPV	294
Recessed Toekick on Back or Side	RECTKBK, RECTKL, RECTKR	21
Reduced Depth	RD	11
Removable Vanity Sink Base	RVWS	174
Roll Tray Kits	RT	317

Description	Code	Page Number
Roll Tray Kits Deep	DRT	317
Roll Tray Plug In Bracket	RTBKXSP	319
Scooped Drawer	SCPDRW	16
Shaker Crown Moulding	SHKRCRM	285
Shelf Pull-down	SHLFPD	315
Shiplap Straight Wood Hood	JWHSHPSTR	105
Shiplap Straight Wood Hood w/Corbels	JWHSHPSTRCB	105
Shiplap Tapered Wood Hood	JWHSHIPT	105
Shiplap Tapered Wood Hood w/Corbels	JWHSHIPTCB	106
Shiplap Wood Hood Chimney	JWHSHIPCH	106
Shoe Moulding — Convex Inside Corner	SHM	293
Signature Mantel Wood Hood	WHSGM	103
Simple Tapered Wood Hood	WHSMT	106
Simple Wood Hood Chimney	WHSMC	107
Single Bead Edge Moulding	SBE	288
Single Bead Moulding	SBM	288
Single Bead Pilaster	SBP	288
Single Door Medicine Cabinet	MC	253
Single Outlet Cover	JSOC	303
Single Rocker Plate	JSRC	303
Sink Base Corner	SBC	139
Sink Base SuperCabinet™	SB..S	132
Sink Base SuperCabinet™ w/CabMat™	SB..SCM	132
Sink Base SuperCabinet™ w/Tilt-out Trays	SB..STS	132
Sink Base SuperCabinet™ w/Tilt-out Trays & CabMat™	SB..STSCM	133
Sink Base w/CabMat™	SB..CM	128
Sink Base w/Tilt-out Trays & CabMat™	SB..STCM	131
Sink Bases	SB	128-130
Sink Bases w/Drawers Below	SB..D	133
Sink Bases w/Tilt-out Trays	SB..ST, SB..CSST	130, 131
Sink Front Bottoms	SFB	134
Sliding Towel Rack	STR	314
Small Corbel	SMCORBEL	300
Small Cove Crown Moulding	SMCOVECROWN	285
Small Crown Moulding	SCM	286
Small Light Rail Moulding	SMLR	291
Small Scribe Moulding	SCRIBE	288
Snack Bar Support 1 1/4"	SBS	302
Soffit Filler Moulding	SFM	287
Soffit Trim Moulding	TSTM	289
Solid-wood Crown Moulding	SWCRM	286
Solid-wood Large Crown Moulding	SWLCRM	286
Solid-wood Super Lazy Susan	SLSW	147
Solid-wood Tall Crown Moulding	SWTCRM	286
Solid-wood Victorian Crown Moulding	SWVCRM	286
Space Fillers	S96	256
Spice Rack Pull-down	SPD	315
Spice Racks	SRCH	314
Spool Leg	SPLEG	297
Square Bar Leg	JSQBARLEG	298
Square Flat Panel Wood Hood	WHSFP	103
Square Island Leg	JSQISLLEG	297
Stacked Diagonal Wall Cabinets	STDW	86
Stacked Wall Cabinets	STW	75-77
Stacked Wall Corner Cabinets	STWC	81
Stain & Paint	QUARTCOLOR, SSC	318
Starter Moulding	STR8	287
Starter Moulding, Shaker	STRS	287
Straight Angle Crown Moulding	SACROWN	285
Straight Batten Wood Hood	WHSBATTEN	108
Straight Valance	VV	294
Super Lazy Susans w/Chrome Rail	SLSCR	148
Super Susans	SIS	147
SuperCabinet™, 30"	BSC30	118
SuperCabinet™, 36"	BSC36	119
Tall Built-in Microwave Cabinet	TBMWB	203-204

Description	Code	Page Number
Tall Built-in Microwave Cabinet, Three Drawer Base	T3DMW	205-206
Tall Crown Moulding	MTCROWN	285
Tall Panel w/Filler Attached & Authentic End	TEP.AEL, AER	271
Tall Pantry Pull-outs	TPP	188
Tapered Leg	TAPLG	300
Tapered Wood Hoods	TWH	109
Tilt-out Trays, Plastic	TOT	315
Tilt-out Trays, Stainless Steel Slim	TOTSSS	17, 315
Toeboards	TB	290
Toekick Cap	TKC	290
Toekick Drawer	DRWTK	22
Toekick Vacuum	TOEKICKVAC	315
Toekick Tulip Foot	TKTLFOOT	300
Touch Latch	TOUCHLATCH	310
Touch-up Tools	GLAZEPEN, MTUK, TUK	318
Traditional Light Rail	JINSERTLRT	292
Tray Divider, Chrome	CTDK	315
Tray Divider Kit	TDKIT	315
Tray Divider Roll-out Kit	TDRO	316
Tray Dividers	TD	18
Triad Corbel	CORBELTRIAD	302
Triple Bead Edge Moulding	TBEM	289
Triple Bead Pilaster Moulding	TBP	289
Tri-View Medicine Cabinets	TV	254
Tulip Foot	TLFOOT	300
Turned Post Island Leg	TURNEPOST	298
Under Counter Drawers	UCD	225, 247
Under Counter Drawers Trimmable	UCDT	225, 247
Under Panel Moulding	UPM	289
Universal Access Base Cabinets	B	171
Universal Access Base Microwave w/Deep Drawer	BMWD..DD	173
Universal Access Desk Leg	VDL..WD	173
Universal Access Sink Base Cabinets	SB	171
Universal Access Sink Base Cabinets w/Tilt-out Trays	SB..ST	171
Universal Access Sink Base, Removable	UASBRF	172
Universal Access Super Lazy Susan	SLS	173
Universal Access Three Drawer Base Cabinets	3DB	173
Urn Leg	JURNLEG	298
Utility Cabinets	U	176-180
Utility Cabinets w/Roll Trays	U..RT	181-183
Utility Organizer Cabinets	UOC	184
Utility Organizer Drop Zone Cabinet	UOCDZ	185
Valance Top Rail	TVRAV, TVRFV, TVRVV	14
Valley Forge Moulding	VFR	292
Vanity Base Easy Reach	VER	233
Vanity Base Wastebasket	VBWB	235
Vanity Bases	V	227-228
Vanity Chrome Roll-out Rack	VCRR	316
Vanity Desk Legs	VDL	271
Vanity Door Drawer Bases	VB	232
Vanity Drawer Bases	VDB	234
Vanity Four Drawer Bases	4VDB	234
Vanity Grooming Pull-out	VGPO	236
Vanity Hamper	VH..FH	247
Vanity Hamper w/Drawer	VBH	247
Vanity Mirror	VM	253
Vanity Pull-out	VP	236
Vanity Sink Bases w/False Drawer Fronts	VSF	229-230
Vanity Sink Bases w/U-shaped Pull-out Trays	VSF.....U	231
Vanity Sink Bases SuperCabinet™ w/Tilt-out Trays	VSSB.....ST	231
Vanity Sink Drawer Bases	VSD	237-242
Vanity Sink Drawer Bases w/Eight Drawers	VSD	246
Vanity Sink Drawer Bases w/Eight Drawers & False Panel	VSD..FP	246
Vanity Sink Drawer Bases w/Six Drawers	VSD	245
Vanity Sink Drawer Bases w/Six Drawers & False Panel	VSD..FP	245
Vanity Sink Three Drawer Bases	VSDS	243

Description	Code	Page Number
Vanity Sink Wide Drawer Base w/False Panels	VSWD..FP	243
Vanity Utility Cabinets	VU	249
Vanity Wall Cabinets	W	252
Vanity Wall Cubby	VWC	252
Vanity Wall Hung Cabinets	VWH	250
Vanity Wall Mirror Cabinets	VWM	252
Vanity Wall Sink	VWS	174
Vanity Wastebasket	VWB	235
Void Toekick	VTK	22
Wainscoting	WAIN	273
Wall Appliance Garage Door	WAGD	95
Wall Appliance Garage Vertical-lift Door	WAGVLD	95
Wall Base Double Door Cabinets	WB	117
Wall Base Single Door Cabinets	WB	117
Wall Box Column Pull-outs (Plain, Overlay)	WBCPO	96
Wall Built-in Microwave Cabinets	WBMW	94
Wall Corner Cabinets	WC	78-80
Wall Cube Horizontal	WCH	100
Wall Double Door Cabinets	W	51-72
Wall End Cabinets	WEC	89
Wall Message Center	WMC	101
Wall Microwave Cabinets	MW	93
Wall Microwave Double Door Cabinets	WMW	93
Wall Organizers	WORG	100
Wall Quarter Round End Shelves	WQRES	90-92
Wall Refrigerator Cabinets	W	52
Wall Refrigerator Pull-out	W..PO	60, 64, 66
Wall Refrigerator Vertical-lift	WVL	59, 63
Wall Shelf Pull-down	W..SHLFPD	98
Wall Single Door Cabinets	W	51-71
Wall Spice Pull-out	WSP	97
Wall Spice Rack Cabinets	WSR	98
Wall Susan Kits	WSK	316
Wall Three Drawer Cabinets	W3D	74
Wall Top Hinge Angle Restriction Clips	WTHRESCLIP	320
Wall Top Hinge Cabinets	WTH	50-63
Wall Two Drawer Cabinet	W2D	72, 73
Wall Vertical-lift	WVL	58-63
Wall Wine Racks	WNR	99
Warming Drawer	DRWWRM	18
Waterfall Wood Hood	WHWF	102
Wide Scribe	WSCRIBE	289
Window Casing—Traditional	WCT	293
Wine Glass Holders	WGH	316
Wine Storage Cabinet	WSC	99
Wood Hood Blowers	BLOWER	110
Wood Tiered K-Cup Drawer	KCUP	313
Wood Tops, Four Sided	4TWT	225
Wood Tops, One Sided	1TWT	223
Wood Tops, Three Sided	3TWT	224
Wood V-grooved Beaded Skin 1/4" Panels	BP..VG	265
Wood V-grooved w/Triple Beaded Front 3/4" Panels (Base, Tall, Wall)	BEP, TEP, WEP..VG	271

Code	Page Number
1TWT	223
2DB	153
2DB..DR	155
2DB..FD	153
2DB..PDO	154
2DB..RT	154
2DB..RTPDO	154
3CDB	151
3DB	155, 173,
	221
3DB..WTC	156
3DBB	156
3DBBDD	157
3DBDD	157
3TWT	224
4DB	158
4DB..WTC	158
4TWT	225
4VDB	234
ACS	13, 134
ACSF	135
ACSF	135
ADDTK	19
ADH	100
ALF	24
ANGLHEATSHIELD	313
ANGLSHIELDSS	313
APC	3
AUTHB, AUTHL, AUTHR	7
AV	293
B	113, 171
B..CIA	152
B..COA	152
B..CWP	125
B..DR	165
B..FH	115, 116
B..FHMIXSC	127
B..FSCO	124
B..PS	123
B..RT	120
B..RTWTC	122
B..TDRO	126
B..WTC	114
BAD	162
BATTEN	287
BBCPO	164
BBM	290
BBMFB	290
BBMSC	290
BBMSH	290
BBMSW	290
BBMWD	167
BC	140
BC..PO	141
BCF	260-262
BCFW	141
BCFW..CPO	142
BCFW..FH	142
BCFW..PO	142
BCFW..SP	143
BCOPP	163
BCP	168
BCP..FH	168
BEC	153
BED	272
BEP	266
BEP..AEL, AER	270
BEP..VG	271
BEPF	268
BEPS	263
BER	146
BERAS	145
BKSOCKET	319
BLOWER	110
BLS	143
BLSBEP	266
BLVDF	260
BMC	165
BMW..DD	167, 173

Code	Page Number
BMW	167
BO	166
BOC	169
BP	264
BP..CRSGR	264
BP..VG	265
BPM	287
BPP	162
BPPP	123
BPS	311
BPT..WB	159
BPT..WBFH	161
BQRES	169
BRACKETIND	304
BRDB	150
BRKOFFSCREW	321
BRMCLP	311
BSC30	118
BSC36	119
BTC	151
BDPP	163
BUMPERPADS	321
BUNLEG	294
BUPP	163
BUPPKB	164
BWB	159
BWB..FH	160
BWBFHLID, BWBLID	311
BWC	161
CABCLEANKIT	318
CABMAT	311
CABMATV	311
CAPM	291
CBO	9
CCM	287
CCO	9
CD	95
CF	255
CFNTO	23
CFP	9
CFRMO	23
CG, CG..BTM, CG..TOP	25
CH	10
CIW	312
CLTCROWN	284
CMAT	15
CND	9
CNTYSB	136
CNTYSB..CM	136
CNTYSB..SA	138
CONVERSION	110
CORBELART9	300
CORBELBAU	303
CORBELCOVE	301
CORBELCR	301
CORBELMIS6	301
CORBELMIS9	301
CORBELWD5	301
CORBELTRIAD	302
COTCROWN	284
COVECROWN	284
CPE	287
CPES	291
CTDK	315
CUDD	312
CW	10
DASPCDF	276
DAB..FS	144
DAB..SLS	144
DADOOR	275
DAPNL	274
DASLBDF	276
DB	153-158
DCM	292
DDFD	222
DDO	220
DER	222
DFD	221
DF5PC	5

Code	Page Number
DF5PCNR	4
DF5PCNRST	5
DF5PCSLBT	5
DFSLB	4
DFSLBT	5
DGBOXLOCK	319
DGK	319
DLEMISSION	297
DOOR	277
DOORSLAB	278
DPSRR	6
DRT	16, 317
DRWPWR	17, 314
DRWSEC	15
DRWTK	22
DRWWRM	18
DW	83-84
DW..D	85
DW..S	85
EDGE BAND	313
ENGISLCOLUMN	295
ER	88
ES	305
ET	16
EXBKL, EXBKR	12
EXL, EXR	13
EZORG	314
F	255
F..R	255
FALSEPNLCLIP50	319
FB	7
FBLR	291
FD	15, 222
FDWB	223
FFDL, FFDR	7
FOLCROWN	284
FOOTMETAL	304
FPEB	7
FS	305
FTK, FTK..FNT.P, FTK.P	19
FTKAV, FTKAV..FNT.P, FTKAV.P	20
FTKAV, FTKAV..FNT.P, FTKAV.P	20
FV	293
GAELICLEG	296
GLAZEPEN	318
HINGE	320
HINGERESCLIP	320
HINGESHIM	320
HL	111
HM	111
HP..21	111
HS	111
ICM	292
ID	11
INSCROWN	284
INSTALLSCR, INSTALLSCREWS	321
INFRM	14
ISLBPNL	274
ISLEGTRD	296
ISLEG	296
JBRACKETART	302
JCORBELCOS13D	301
JCORBELCRAFTO	302
JCOSFOOT	299
JCOSMOLEG	295
JCRAFTFOOT	299
JCRBUNFOOT	299
JENGCNTYLEG	295
JESTATELEG	295
JESTATELEGS	295
JESTATELEGSS	295
JGSK	306
JINSERTLRC	292
JINSERTLRT	292
JMADEFOOT	299
JMETROFOOT	299
JPALLAFOOT	299
JPALLALEGT	297
JPWRPOD	314

Code	Page Number
JRCPV	294
JRPV	293
JSOC	303
JSQBARLEG	298
JSQISLLEG	297
JSRC	303
JURNLEG	298
JWHCA	107
JWHCS	108
JWHL	104
JWHSHPCH	106
JWHSHPSTR	105
JWHSHPSTRCB	105
JWHSHIPT	105
JWHSHIPTCB	106
KCUP	313
KNOB	307
L	249
LB	291
LBRM	288
LCHAMPERLNR	313
LCR	248
LGCORBEL	300
LGSQFOOT	299
LIDSTAY, LIDSTAYHD	320
LIFOOT	300
LO	313
LOSC	292
LRM	291
LSACROWN	284
LSHAKER	285
LSP	150
LT	248
LTD	249
MC	253
MD, MD..BTM, MD..TOP	26
MDCRNSHLF	305
MDFLCRNSHLF	305
METBARCOLUMN	296
METISLCOLUMN	296
MFO	6
MIP	8
MIXKITFHSC	311
MSACROWN	285
MTCROWN	285
MTUK	318
MW	93
OC135	293
OC, OC..DD	197-202
OCINSTALLKIT	313
OCM	292
OC..DD	195-196
OGHEM	288
OL	256
OL..MFO	257
OMC, OMC..DD	207-210
OS3D	193-194
OSB	191-192
P	23
PDM	321
PDO, PDOPOSTS	313
PE	3
PFALSEPNLCLIP50	319
PFINBTMB	12
PPP	314
PRMD	28
PTOWB	17
PTU	187
PTUS	186
PULL	307
PWT	190
PY	189
QRM	293
QUARTCOLOR	318
RD	11
RECTKALL	21
RECTKBK	21
RECTKL	21
RECTKR	21

Code	Page Number
RETCLIP.BAG	321
RT	16, 317
RTBFH	166
RTBKXSP	319
RVWS	174
S96	256
SACROWN	285
SB	128-130, 171
SB..CM	128
SB..D	133
SB..S	132
SB..SCM	132
SB..ST	130, 171
SB..STCM	131
SB..STS	132
SB..STSCM	133
SBC	139
SBE	288
SBM	288
SBP	288
SBS	302
SCM	286
SCPDRW	16
SCRIBE	288
SFB	134
SFM	287
SHELFPEGS	321
SHKRCRM	285
SHLFPD	315
SHM	293
SHMD	27
SK	306
SLS	147, 173
SLSR	148
SLSW	147
SM	288
SMCORBEL	300
SMCOVECROWN	285
SMLR	291
SOFFITA	291
SOFFITE	291
SPACERBLK	319
SPD	315
SPLEG	297
SRCH	314
SSC	318
STBRACKETIND	304
STDW	86
STR	314
STR8	287
STRS	287
STRTHEATSHIELD	313
STRTHSHIELDSS	313
STW	75
STWC	81
SWCRM	286
SWLCRM	286
SWTCRM	286
SWVCRM	286
T3DNW	205-206
TAPLG	300
TB	290
TBC	216-217
TBCD	218-219
TBEM	289
TBMWB	203-204
TBP	289
TCM	287
TD	18, 126
TD..FH	127
TDKIT	315
TDRO	316
TED	272
TEP, TEP.AEL, TEP.AER	266, 271
TEP.VG	271
TEPS	263
TF	255
TKC	290

Code	Page Number
TKP	21
TKTLFOOT	300
TLFOOT	300
TOEKICKVAC	315
TOT	315
TOTSSS	17, 315
TOUHLATCH	310
TPP	188
TSTM	289
TUK	318
TURNEDPOST	298
TV	254
TVRAV, TVRFV, TVRVV	14
TWH	109
U	176-180
U..RT	181-183
UASBRF	172
UCD	225, 247
UCDT	225, 247
UOC	184
UOCDZ	185
UPM	289
V	227-228
VB	232
VBEP	267
VBH	247
VBWB	235
VCRR	316
VDB	234
VDL	271
VDL..WD	173
VER	233
VFR	292
VGPO	236
VH..FH	247
VM	253
VP	236
VSB	229-230
VSB.....U	231
VSD	237-246
VSD..FP	245, 246
VSDS	243
VSSB.....ST	231
VSWD..FP	243
VTK	22
VU	249
VV	294
VWB	235
VWC	252
VWH	250
VWM	252
VWS	174
W	51-72, 252
W..BC	212
W..PO	60, 64, 66
W..SHLFPD	98
W2D	72, 73
W3D	74
WAGD	95
WAGVLD	95
WAIN	273
WB	117
WBCPO	96
WBMW	94
WC	78-80
WCH	100
WCT	293
WEC	89
WED	272
WEP	267
WEP.VG	271
WEPS	263
WFBC	214
WGH	316
WHA	101
WHAFP	103
WHAS	102
WHC	104

Code	Page Number
WHCA	107
WHCFS	102
WHCS	108
WHS	103
WHSBATTEN	108
WHSFP	103
WHSGM	103
WHSMC	107
WHSMT	106
WHWF	102
WMC	101
WMF	288
WMW	93
WNR	99
WORG	100
WQRES	90-92
WSC	99
WSCRIBE	289
WSK	316
WSP	97
WSR	98
WTCO	312
WTH	50-63
WTHRESCLIP	320
WVL	58-63

NOTES

POLICIES

Humidification

<https://www.masterbrandcabinets.com/humidification>

Installation Instructions

<https://www.masterbrandcabinets.com/installation>

Care and Cleaning

<https://www.masterbrandcabinets.com/care-and-cleaning>

Warranty

Mid Continent® Signature™ has a Limited Lifetime Warranty. For terms and conditions, please visit: <https://www.midcontinentcabinetry.com/get-started/love-your-space/warranty>

DECORATIVE APPLIANCE PANELS

If a decorative appliance panel is required, use the Decorative Appliance Panel Request Form located on MasterBrand Connect.

WOOD DUST WARNING

When cutting, sanding, sawing, or shaping cabinets or wood products, you are likely to generate wood dust. For your own safety, we recommend that you wear a protective mask to prevent breathing wood dust. We also recommend eye protection to avoid injury by flying wood chips or sawdust during cabinet installation.

CERTIFICATIONS

ANSI A161.1

Our products meet or exceed the ANSI A161.1 performance and construction standards for kitchen and vanity cabinets as certified by ICC-ES (International Code Council Evaluation Service). Learn more at [masterbrandcabinets.com/certifications](https://www.masterbrandcabinets.com/certifications).

TSCA Title VI

TSCA Title VI is a U.S. regulation that sets formaldehyde emissions standards for composite wood products, such as hardwood plywood, medium-density fiberboard, and particleboard, as well as products containing them, such as furniture. It requires composite wood products to be tested and certified by EPA-recognized third-party certifiers using specific methods. This federal regulation applies to all states and territories in the U.S. and is identical to the California Air Resources Board (CARB) rule. Learn more at [masterbrandcabinets.com/certifications](https://www.masterbrandcabinets.com/certifications).

CARB Compliance - Formaldehyde Emissions

Mid Continent Signature Cabinetry is committed to offering solutions that meet or exceed air emissions rules and regulations. All composite wood products used in the construction of our cabinets, which includes end panels, bottoms, backs, shelves, toekicks and corner blocks, are compliant with emissions limits under EPA TSCA Title VI, CARB Phase 2 and HUD.



Dear Mid Continent® Signature™ Customer,

Congratulations on your selection of Mid Continent Signature cabinetry with an Heirloom finish. Because of its unique characteristics, this finish is quite different from other cabinetry finishes you may be familiar with. Your satisfaction is important to Mid Continent Signature, and we want you to fully understand the characteristics that make an Heirloom Finish unique.

The finish will be sanded through the base coat to expose the surface of the wood. This type of sand through on the edges and profiles creates a naturally worn appearance. If a finish is chosen with a glaze, the glaze will be applied after sanding has been done. This will enhance those areas of exposed wood to take on the darker characteristics of the applied glaze.

Normal Characteristics of Painted, Sand-Through Finishes include:

- Hairline Cracking
- Visible textures of natural grain patterns
- Variation in rub through and wear techniques

Accordingly, we ask that the following agreement be signed for Heirloom Finish orders.

I have read the foregoing and find the characteristic variations of wood with Heirloom finish are desirable. As such, I agree not to hold Mid Continent Signature and/or the Mid Continent Signature dealer listed below responsible in the event that these characteristics are later found by me to be less desirable than I had expected.

Customer Signature

Dealer Signature

Customer Name (please print)

Dealer Name (please print)

Dealer Purchase Order Number



Dear Mid Continent® Signature™ Customer,

Congratulations on your selection of Mid Continent Signature cabinetry in a Paint or Paint with Glaze finish. Because of its unique characteristics, this finish is quite different from other cabinetry finishes you may be familiar with. Your satisfaction is important to Mid Continent Signature, and we want you to fully understand the characteristics that make painted finishes so distinctive.

It is important to realize that the beauty of wood cabinetry comes from the natural qualities of wood itself. Mid Continent Signature utilizes only select solid hardwoods and veneers. The beauty of these genuine woods lies in the variation of the grain. The textures of those natural grain patterns often remain visible with paint finish and should be accepted as inherent characteristics when selecting painted cabinetry. When ordering painted Maple 5-piece styles (except Windsor), the door's center panel will be constructed of MDF material.

On both Maple and MDF, seam lines and hairline cracking at stile, rail and panel joints are normal characteristics of painted finishes and should not be considered a reason for product replacement. Over time, there may be a slight color shift in the paint finish due to the continued exposure to natural and artificial light sources. We mention these characteristics because neither Mid Continent Signature nor your Mid Continent Signature dealer can be responsible for these conditions and variations.



Example of front joint separation



Example of front joint separation



Example of end joint separation

Accordingly, we ask that the following agreement be signed for Paint Finish orders.

I have read the foregoing and find the characteristic variations of wood and MDF with painted finish are desirable. As such, I agree not to hold Mid Continent Signature and/or the Mid Continent Signature dealer listed below responsible in the event that these characteristics are later found by me to be less desirable than I had expected.

Customer Signature

Dealer Signature

Customer Name (please print)

Dealer Name (please print)

Dealer Purchase Order Number



Dear Mid Continent® Signature™ Customer,

Congratulations on your selection of Mid Continent Signature cabinetry in Rustic Alder. Because of its unique characteristics Rustic Alder is quite different from other wood types you may be familiar with. Your satisfaction is important to Mid Continent Signature, and we want you to fully understand the characteristics that make Rustic Alder so distinctive.

It is important to realize that the beauty of wood cabinetry comes from the natural qualities of wood itself. Rustic Alder is characterized by its light brown and reddish undertones and may contain a variety of pin holes, open and closed knots of various sizes and colors, small cracks, bird pecks, mineral streaks, and grain variation. Some knots may have small holes through the panel. In addition, the wood will contain color difference caused by variations in minerals found in the soil, creating visible mineral tracks. However, those characteristics that might compromise the structural integrity of the door will not be included.

Sound Closed Knot (not moveable) – Expected in Rustic Alder up to approximately 3” diameter.

Sound Knot with Cracks – Expect sound knots with open cracks up to approximately 1” in length.

Open Knot (through door) – Expected in Rustic Alder with open area up to approximately 3/4” diameter.

Note: 3/4” diameter is about the size of a penny. Holes created by open knots pass completely through the door and are desirable for this rustic look.

Unsound Knot (moveable core) – Not to be expected.

Knot Cluster (cluster of tight sound knots) – To be expected in Rustic Alder.

Worm Holes/Pin Holes (can go through door) – Can be expected on Rustic Alder up to approximately 1/4” diameter.

Worm Tracks – Can be expected on Rustic Alder in sizes up to approximately 1/8” wide by 8” long.

Doors, drawer fronts, and selected trim items will feature rustic characteristics. Other areas of the product will utilize standard Alder. Customers should expect a much lower occurrence of rustic characteristics in these other areas. Also, the natural characteristics mentioned occur randomly in Rustic Alder. All doors and drawer fronts will contain some combination of the common Rustic Alder markings; however, it will be uncommon to find all markings on any single piece.

The natural characteristics of wood described above and variations in grain patterns and color are not considered reasons for product replacement. We mention these characteristics because neither Mid Continent Signature nor your Mid Continent Signature dealer can be responsible for these conditions and variations.

Accordingly, we ask that the following agreement be signed for Rustic Alder orders.

I have read the foregoing and find the characteristic variations of wood with Rustic Alder are desirable.

As such, I agree not to hold Mid Continent Signature and/or the Mid Continent Signature dealer listed below responsible in the event that these characteristics are later found by me to be less desirable than I had expected.

Customer Signature

Dealer Signature

Customer Name (please print)

Dealer Name (please print)

Dealer Purchase Order Number



Dear Mid Continent® Signature™ Customer,

Congratulations on your selection of Mid Continent Signature cabinetry in Rustic Hickory. Because of its unique characteristics Rustic Hickory is quite different from other wood types you may be familiar with. Your satisfaction is important to Mid Continent Signature, and we want you to fully understand the characteristics that make Rustic Hickory so distinctive.

Rustic Hickory is a strong, heavy hardwood known for distinctive graining patterns. Color will vary from nearly white to dark brown, with wild, flowing grain patterns and dramatic color variations. Rustic Hickory can have a fine uniform grain to large knots appearing black and brown in color of various shapes and sizes, sapwood, mineral and some checking.

Sound Closed Knot (not moveable) – Expected up to approximately 3” diameter.

Sound Knot with Cracks – Expect sound knots with open cracks up to approximately 1” length.

Open Knot (through door) – Expected with open area up to approximately 3/4” diameter.

Unsound Knot (moveable core) – Not to be expected.

Worm Holes/Pin Holes (can go through the door) – Can be expected up to 1/4” diameter.

Worm Tracks – Can be expected in sizes up to approximately 1/8” wide by 8” long.

Note: 3/4” diameter is about the size of a penny. Holes created by open knots pass completely through the door and are desirable for this rustic look.

Doors, drawer fronts, and selected trim items will feature rustic characteristics. Other areas of the product will utilize standard Hickory.

The natural characteristics of wood described above and variations in grain patterns and color are not considered reasons for product replacement. We mention these characteristics because neither Mid Continent Signature nor your Mid Continent Signature dealer can be responsible for these conditions and variations.

Accordingly, we ask that the following agreement be signed for Rustic Hickory orders.

I have read the foregoing and find the characteristic variations of wood with Rustic Hickory are desirable.

As such, I agree not to hold Mid Continent Signature and/or the Mid Continent Signature dealer listed below responsible in the event that these characteristics are later found by me to be less desirable than I had expected.

Customer Signature

Dealer Signature

Customer Name (please print)

Dealer Name (please print)

Dealer Purchase Order Number

EXPRESS RESPONSE PROGRAM - GUIDELINES

Our Commitment to Designers and Customers

Purpose

The Express Response™ program is used to expedite orders when customers need product faster than normal lead-time to correct issues with an existing order. Below is an overview of the Express Response program and what you can expect from our commitment to superior service.

Express Response Guidelines

- Eligible orders must be associated with a previous order number.
- Lead time calculation is based on receipt of a clean order. Clean orders are orders in which all information is provided and accurate.
- There is no additional upcharge for Express Response.
- There are no cancellations or returns once an Express Response order is received.
- Due to the nature of Special Product Requests and appliance panels, they are excluded from Express Response and will be processed as a standard lead-time order.
- Express Response is available within the continental United States. Should Alaska, Hawaii or international shipments be required, customer service representatives are ready to assist by providing shipping information and determining lead times.

Questions?

Contact Customer Service for estimated lead times.

NOTES

NOTES



Enlightened.™ This is Mid Continent.™

Designer Photo Submission Call for Entries!

Don't miss out on the opportunity to have your design work featured on MasterBrand's website, social media, literature and beyond. We want to promote you by spotlighting your design talent.

Submission is simple via the Mid Continent Brand Portal on MasterBrand Connect.

TIPS AND REQUIREMENTS:

- A brief tutorial is available on Connect to navigate you through the simple submission tool.
- The submission form is within the Brand Portal section on Connect.
- A 'consent for use' form is required for each submission and is also available on Connect.
- Image quality, size, and theme will be taken into consideration for specific usability.
- Submission of media does not guarantee public use, but all submissions are reviewed for consideration and may be used internally.

HOW TO TAKE A BEAUTIFUL PHOTO

Taking a post worthy in-home photo with your mobile device can be simple! For helpful tips and tricks on lighting, exposure, and getting the right angle, visit MasterBrand Connect to view our valuable reference guide.



Share your Mid Continent designs
with us by scanning the QR code.



SIGNATURE™ SERIES

PIVOT™ SERIES

Share your design with us by tagging us on social with #MidContinentCabinetry.



Styles, product availability and construction may vary slightly from those shown in this book due to material availability and/or design evolution. Specifications are subject to change without notice. Customer service is available if your design requires verification of product availability and specifications.

Product photography and illustrations have been reproduced as accurately as printing technologies permit. To ensure highest satisfaction, we strongly recommend you view an actual sample for best color, wood grain and finish representation.

Mid Continent Cabinetry® has a Limited Lifetime Warranty.

For terms and conditions, please visit www.midcontinentcabinetry.com/warranty

Customer Service

Hours: Mon - Fri, 8:30 AM - 6:00 PM EST

Phone: 888-835-0268

Please reference Service Policies at masterbrandconnect.com

Designer ID #: _____

Customer Account #: _____

Sales Rep: _____



Part of the MasterBrand® Family

midcontinentcabinetry.com
#MidContinentCabinets
© 2024 MasterBrand Cabinets LLC
All rights reserved.