

MC

mid continent.
CABINETS

PIVOT SERIES

Price & Specification Guide

August 2024

SUPERSEDES ALL PRIOR VERSIONS

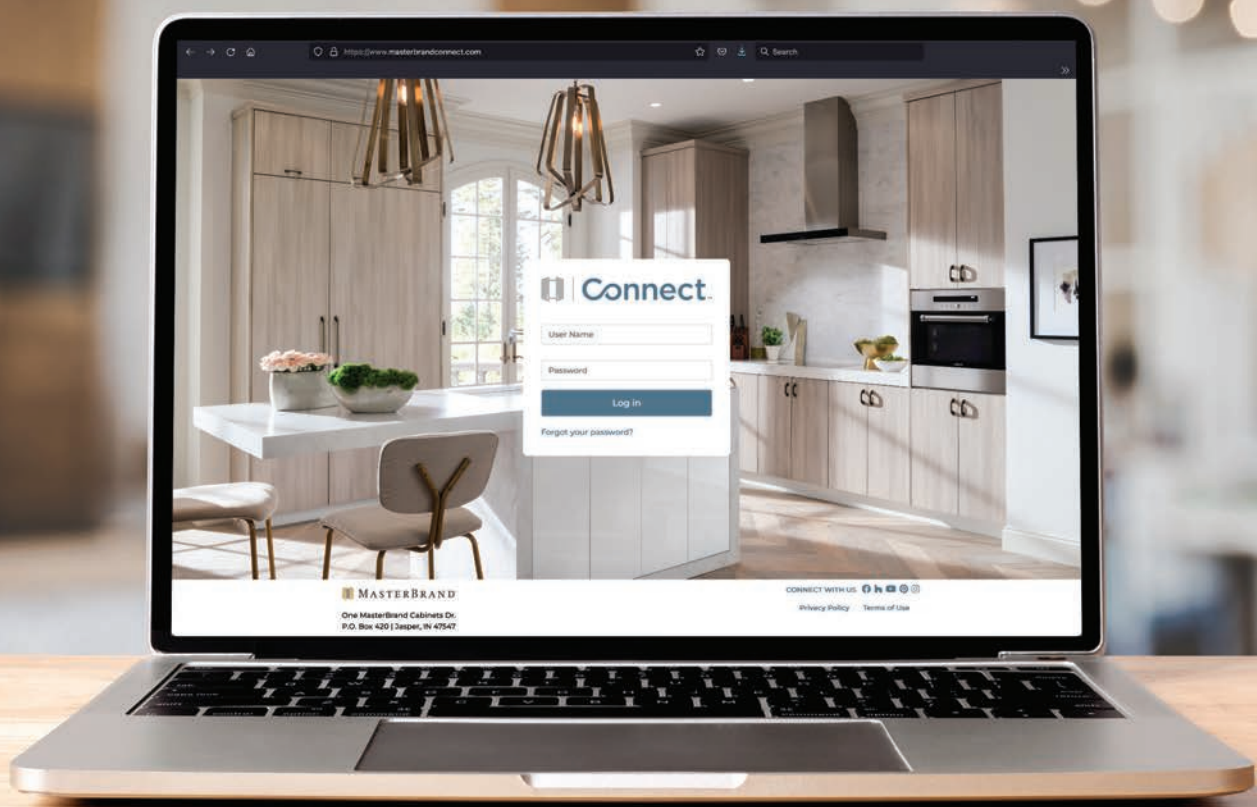

Your Destination for a Next-Level Customer Experience

MasterBrand Connect™ is a one-stop information portal aimed at enabling you to be in the driver's seat of your success. Within Connect, you have access to personalized dashboard content, improved order tracking, customer service case visibility, and much more. The result is an easy to navigate system with must-have information at your fingertips.

Feature Highlights:

- ✓ Mobile-friendly design with improved navigation and easier-to-use interface
- ✓ Unique log-ins per user with personalized content and preferences
- ✓ Improved search capability including POs and acknowledgement numbers
- ✓ Customer Service case visibility
- ✓ More timely order tracking with connected order visibility
- ✓ Communication preference selections
- ✓ Self-service account changes like phone, address and email



Check it out today at [masterbrandconnect.com](https://www.masterbrandconnect.com), or scan the code.

If you do not have a MasterBrand Connect account, please contact your Sales Representative to sign up.

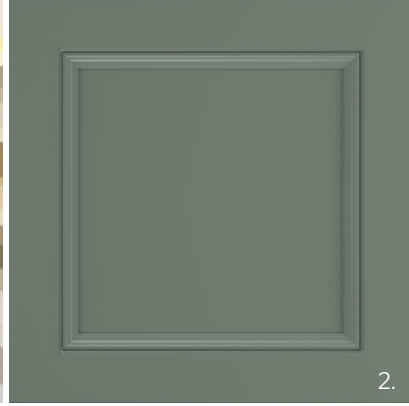
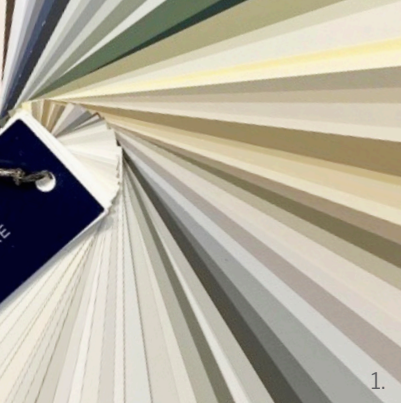

ELEVATE Your Experience

YOUR GUIDE TO WHAT'S JUST IN

AUGUST 2024

Indulge in all that's new for Mid Continent®. You'll find inspiring new finishes, a trend-forward door style, and a variety of new SKUs at your fingertips to bring fashionable and functional designs to life.

LET'S JUMP IN.

COLOR BY NUMBER

1. Achieve the color vision of your mind's eye with Mid Continent's new Color By Number program! This program includes any color in the Sherwin-Williams® and Benjamin Moore® paint families, giving you thousands of choices to create your unique space.

● Signature Series – Maple and MDF

NEW PAINT FINISHES

2. RETREAT PAINT

● Signature Series – Maple

● Pivot Series – Painted Hardwood

(Launched March 2024 in Pivot Series)

3. MARCONA PAINT

● Signature Series – Maple and MDF

NEW STAIN FINISH

4. COASTLINE STAIN

● Pivot Series – Oak and Maple

NEW DOOR STYLE

5. HENRI

● Signature & Pivot Series

(Launched March 2024 in Pivot Series)

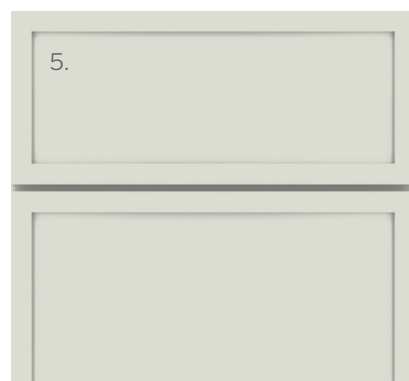
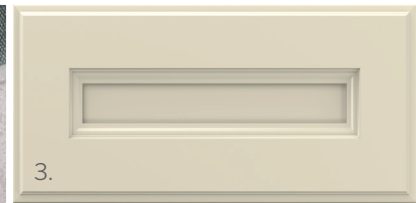



NEW WOOD HOODS

(Launched March 2024 in Pivot Series)

ARTISAN STRAIGHT WOOD HOOD

S P Signature & Pivot Series

WATERFALL WOOD HOOD

S P Signature & Pivot Series

CRAFTSMAN STRAIGHT WOOD HOOD

S P Signature & Pivot Series

SIGNATURE MANTEL WOOD HOOD

S P Signature & Pivot Series

NEW SKUS

(Launched March 2024 in Pivot Series)

120" TALL PANELS, SKINS & FILLERS

P Pivot Series

CHANGES TO MAKE NOTE OF:

PAQUETTE DOOR AND DRAWER FRONT CHANGE

S Signature Series

Changed to Flat Panel with DPSRR option and reduced price by 1 price column.
Drawer Front Rail Inside Profile changed to match door inside profile.

CPES MOULDING

S Signature Series – Rustic Hickory

P Pivot Series – Cherry, Maple, Oak, PureStyle and Laminate

RECESSED TOEKICK MODIFICATION AVAILABILITY

REMOVED FROM CORNER CABINET SKUS

S P Signature & Pivot Series

FOXHALL GREEN TO HAVE MATCHING

LAMINATE ENDS ON STANDARD CONSTRUCTION

S Signature Series

108" PANEL ADDED INCREASED DEPTH

S P Signature & Pivot Series



TABLE OF CONTENTS	
Door and Finish Options	F
Construction Features	1
Modification/Upgrade Compatibility Chart	2
Construction Upgrades	3
Drawer Front and Door Options	4
Non Soft-close Options	5
Custom Modifications	6-14
Specialty Doors	15-16
Decorative Glass Inserts	17-18
Cabinet Dimensions	19-26
Design Checklist	27
NKBA Guidelines	28-29
Innovative Options Reference Chart	30
Wall Cabinets	31-62
Base Cabinets	63-84
Universal Access Cabinets	85-88
Tall Cabinets	89-104
Office & Furniture Cabinets	105-110
Vanity Cabinets	111-122
Fillers	123-125
Panels & Skins	126-131
Stack Moulding Kits	132-134
Moulding	135-139
Valances	140
Embellishments	140-144
Shelves	144-145
Decorative Hardware	146-150
Cabinet Accessories	151-153
Roll Tray Kits	154
Stain, Paint, & Touch-up Tools	154
Guide Kits and Parts	155
Hinges	156
Doors, Drawer Fronts and Drawers	157
Miscellaneous Parts	157
Index by Description	158-160
Index by Code	161
Painted Hardwood Finish Agreement/Policies & Information/Terms and Conditions	

DOOR AND FINISH OPTIONS

This section contains information regarding the global options you will choose that will apply to your entire order: species/material characteristics, door options, and finish options.

CHARACTERISTICS OF LAMINATE

The surfaces of doors, drawer fronts, and overlay fillers feature laminate materials with an integrated top coat that provides superior beauty, durability, and performance. The core panel material is made of MDF to ensure a consistent and stable product.

A heat shield is required to separate all laminate products from heat producing units to be in compliance with cabinet warranty.

CHARACTERISTICS OF PURESTYLE™ LAMINATE

PureStyle™ is an innovative laminate that is applied to a wood or engineered wood substrate. Characteristics include crisp styling, consistent coloration, and abrasion-resistant durability.

These doors offer the durability of a laminate and the beauty of paint while bringing peace of mind to those who care about creating a better environment — both inside and outside of their homes.

PureStyle™ doors can be distinguished from painted cabinets by their picture perfect distribution of satin smooth color on a sleek surface with optimum durability. Trim items will feature a matching painted finish except where noted in product specifications.

A heat shield is required to separate all laminate products from heat producing units to be in compliance with cabinet warranty.

In the Species Availability charts throughout the book, refer to Laminate column for PureStyle™ availability.

CHARACTERISTICS OF WOOD TYPES

No matter which species you choose for your new kitchen or bath cabinetry, please keep in mind that no two pieces of wood are exactly the same. Stains are likely to exaggerate the difference between open and closed grains and other markings in wood. Grain variation and color change should be expected. As hardwood ages, it will darken when exposed to different types of light. Color differences or changes in wood can also be caused by exposure to harsh chemicals, extreme heat or moisture. Additionally, wood species exhibit other defining characteristics, such as mineral deposits/streaks, knots, sap runs, pin holes and wormholes. These markings make the wood unique and contribute to its enduring beauty.

Cherry - features a uniform grain pattern that may reveal pin knots, curled graining and occasional black mineral streaks. With predominantly red undertones, expect color variation from creamy white to deep brown, especially in natural and lighter finishes. Cherry darkens with age and the darkening process is enhanced by exposure to natural light.

Maple - is a tight-grained, uniform hardwood that may include fine brown lines, wavy or curled markings, bird pecks and mineral streaks. It is predominately white to creamy-white in color with occasional reddish-brown tones.

Oak - is an open-grained hardwood that may contain knots, wormholes and highly varying grain patterns, adding to the unique characteristics of the wood. Oak's coloration ranges from white to pink and reddish tones. Streaks of green, yellow and even black may appear due to mineral deposits.

Painted Hardwood - finishes combine hardwoods and engineered materials including solid-wood, engineered materials — such as medium density fiberboard (MDF) and high density fiberboard (HDF) — and similar composite materials providing a smoother surface for painting and superior stability, consistency, and durability.

In keeping with our practice of continuous product improvement and/or to maximize efficiencies, Mid Continent® Pivot™ Cabinetry may adjust specifications in design and materials as it deems necessary. Where differing materials are utilized, they will be of similar or better quality in keeping with Mid Continent Pivot Cabinetry's commitment to quality.

Door Style Reference Number Chart

Your Mid Continent® Pivot™ price guide contains charts with prices for each cabinetry product, arranged according to a numerical code. Use the chart below to determine the price code for your preferred cabinetry style.

F2

DOOR STYLES

	Cherry	Maple	Oak	Laminate	Painted Hardwood	PureStyle™
Berkley FO		7			7	5
Berkley PO		6			6	4
Brawny FO	9	7			7	5
Dapper FO	9	7	6		7	7
Detailed FO	9	7			7	
Detailed PO	8	6			6	
Henri FO 		4			4	
Perry FO	9	7			7	
Simple FO	7	4	3		4	3
Simple PO	6	3	2		3	2
Slab FO	7	4		3	4	
Slim FO	6	3	2		3	
Slim PO	5	2	1		2	
Stevenson FO	11	10			10	
Traditional FO	8	6	4		6	
Traditional PO	7	5	3		5	

Anywhere you see  will take you directly to this page.

To return to your product page, just click the [BACK](#) button.

DOOR STYLE SPECIFICATIONS

Cherry

- When Cherry door styles are ordered, it is recommended to apply a finished end option or a veneer end panel for exposed ends due to the natural aging of Cherry.

All Door Styles

- All doors and drawer fronts are 3/4" thick unless otherwise noted.

Door and Drawer Front Side Profiles

- Veneer and MDF components are shown with gray shading on side profiles. Solid-wood components do not have shading.

Wood Grain

- See reference images for wood grain direction on all door styles.

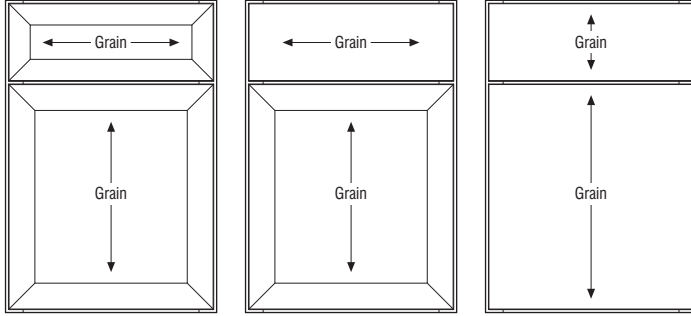

Slab FO

- **Wood Grain - Wall Top Hinge (WTH) Cabinets, 30"-36" Wide**

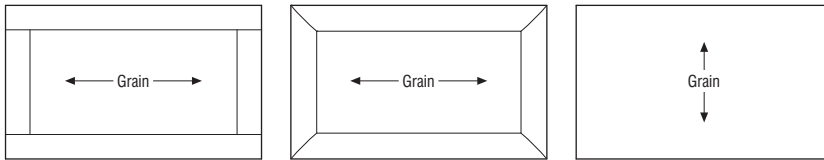

Non-mitered Door Styles

Mitered Door Styles

Slab FO

FULL OVERLAY DOOR STYLES

F4

DOOR STYLES

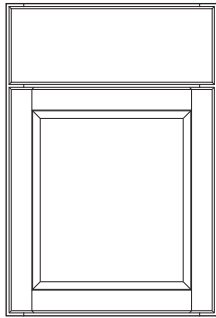

Berkley FO
(Wood Species)

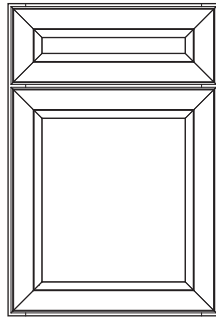

Berkley FO
(PureStyle™)

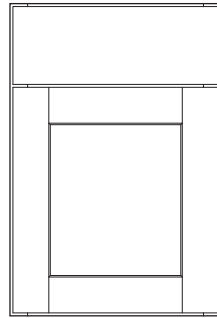

Brawny FO
(Wood Species)

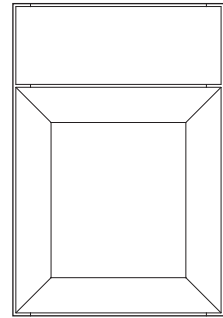

Brawny FO
(PureStyle™)

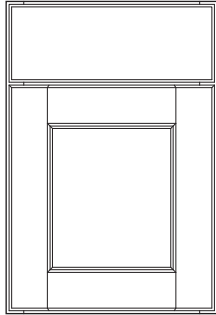

Dapper FO
(Wood Species)

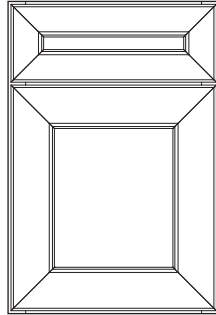

Dapper FO
(PureStyle™)

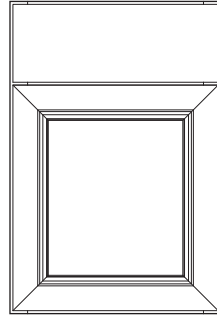

Detailed FO

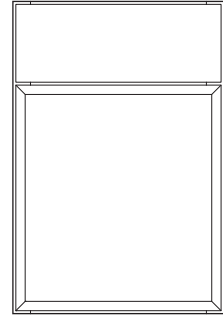

Henri FO **NEW**

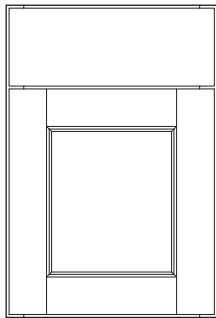

Perry FO

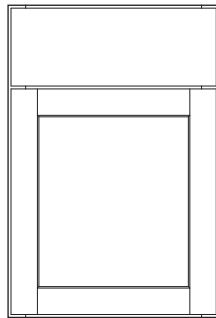

Simple FO
(Wood Species)

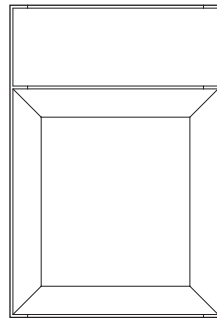

Simple FO
(PureStyle™)

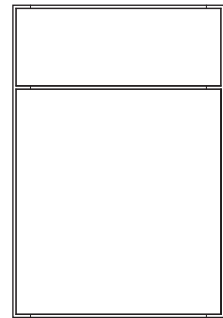

Slab FO

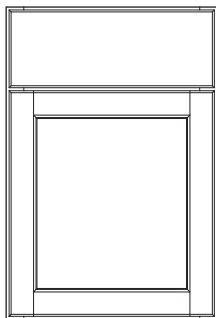

Slim FO

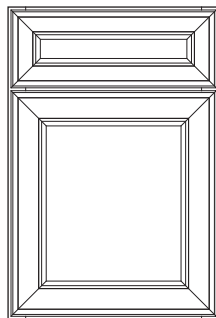

Stevenson FO

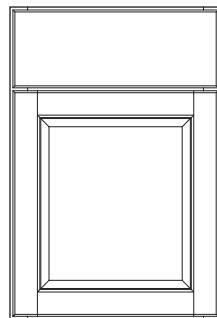

Traditional FO

PARTIAL OVERLAY DOOR STYLES

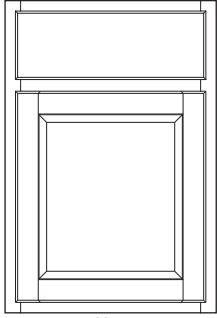

Berkley PO
(Wood Species)

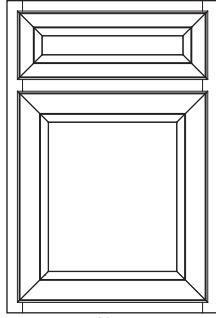

Berkley PO
(PureStyle™)

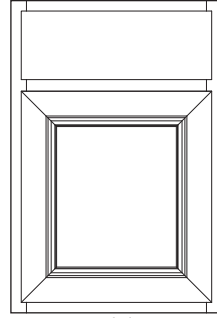

Detailed PO

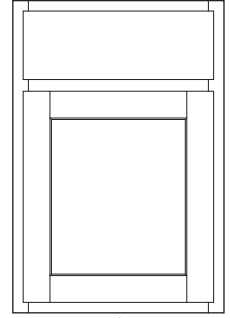

Simple PO
(Wood Species)

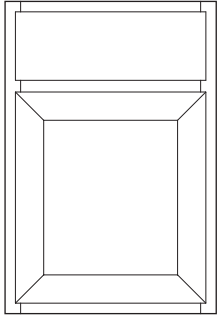

Simple PO
(PureStyle™)

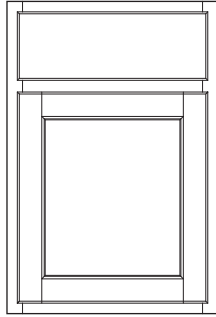

Slim PO

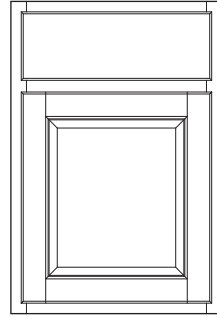

Traditional PO

OVERLAY SPECIFICATIONS

F6

DOOR STYLES

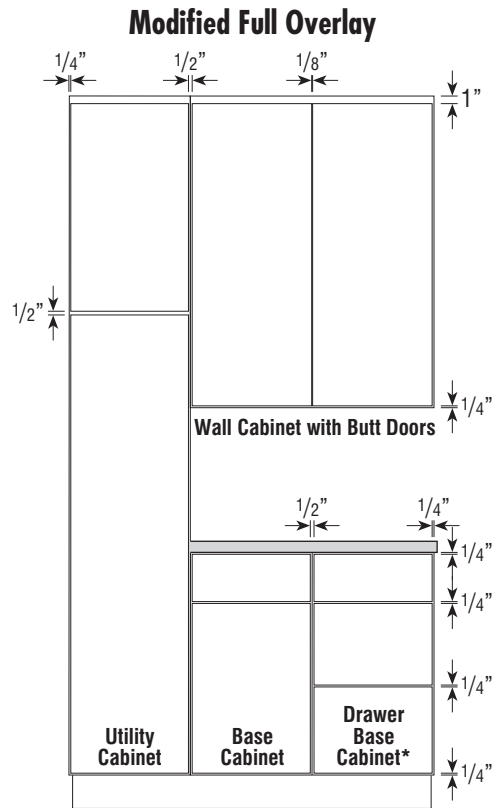
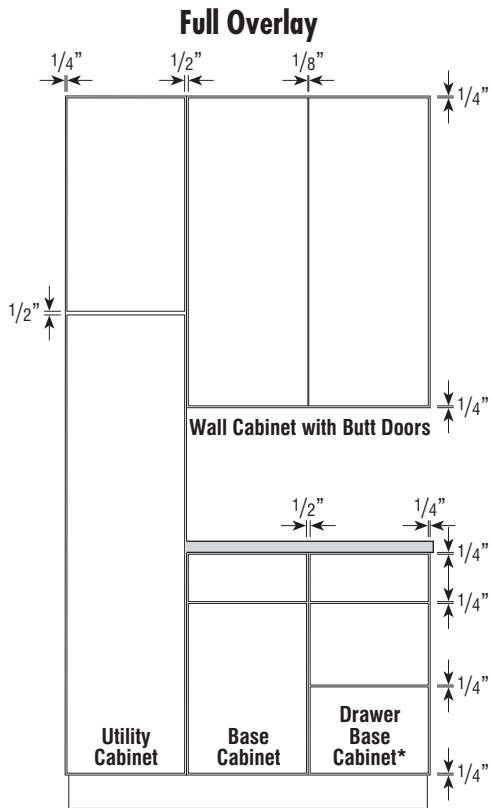

Full Overlay

The door and drawer fronts overlay the frame, exposing 1/4" on the top and bottom rails and right and left stiles of base cabinets. Typical base units with a center stile expose 1/2" of that stile.

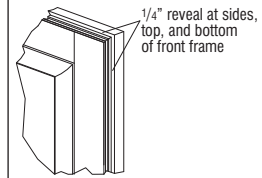

Full Overlay

Modified Full Overlay

Wall and Tall Cabinets: The door and drawer fronts overlay the frame exposing 1/4" on the bottom rail and right and left stile. One full inch is exposed on the top rail of wall and tall cabinets. Typical units with a center stile expose 1/2" of that stile.

Base Cabinets: The door and drawer fronts overlay the frame, exposing 1/4" on the top and bottom rails and right and left stiles of base cabinets. Typical base units with a center stile expose 1/2" of that stile.

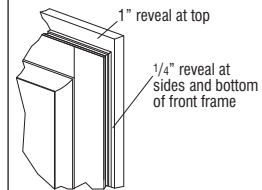

Modified Full Overlay (Wall and Tall)

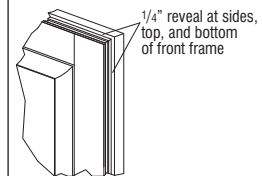

Modified Full Overlay (Base)

*34 1/2" high application shown. On 32" high Full Overlay three drawer applications (drawer bases and sink bases with drawers), the reveal above the bottom drawer front is 1/2".

- One double door center stile cabinet has the same reveal as two single door cabinets.

OVERLAY SPECIFICATIONS

Partial Overlay

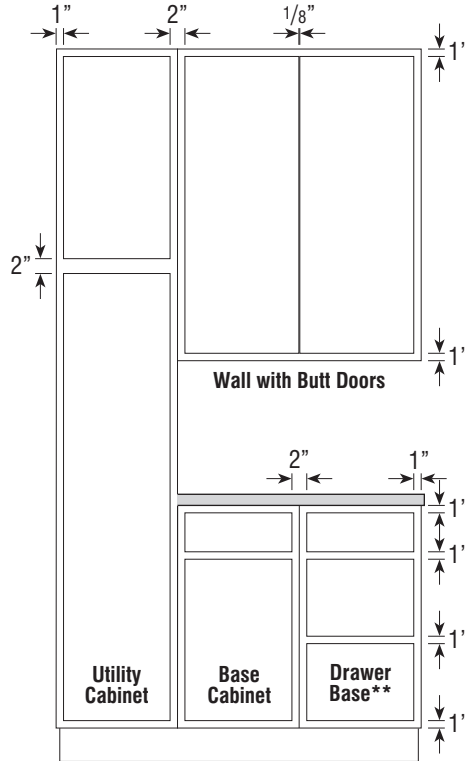

F7

DOOR STYLES

Partial Overlay

The door and drawer fronts overlay the face frame $1/2$ ", exposing 1" of the frame both on the stile and rail members. Typical wall and base cabinets with a center stile expose 2" of that stile.

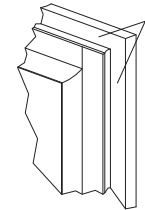

1" reveal at sides, top, and bottom of front frame

Exceptions on Face Frame Reveals

- Some oven units have 3" stiles and 9" intermediate rails (designed for universal flexibility of cut-out options) that create various reveals.
- Blind corner wall and base cabinets expose different center stile reveals. Diagonal corners also vary.
- Please see the dimensional charts for oven units and blind bases located in those sections.

*On Partial Overlay 2DB__ (Two Drawer Bases), reveal above the bottom drawer front is 2".

DOOR STYLES

Berkley FO

	Cherry	Maple	Oak	Laminate	Painted Hardwood	PureStyle™
Price Point	—	7	—	—	7	5

F8

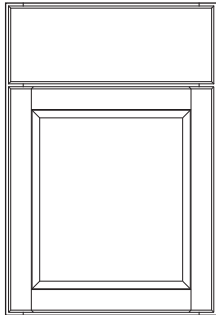

Base (Wood Species)

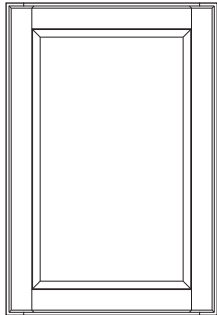

Wall (Wood Species)

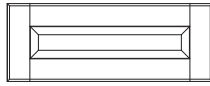

Optional Drawer Front:
Flat 5-piece (DFF5PC)

Decorative Door Options

CG	MD	MFO
•	•	•

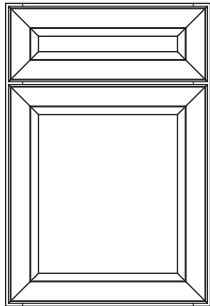
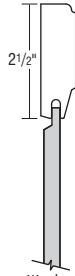
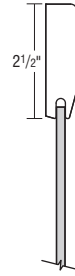
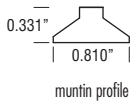

Base (PureStyle™)

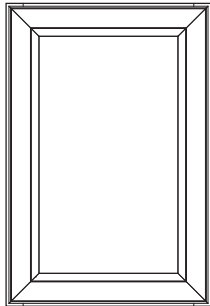

Wall (PureStyle™)

Decorative Door Options

CG	MD	MFO
•	•	•

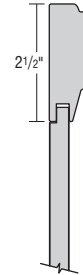
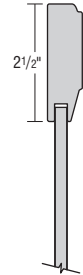
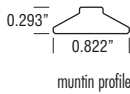

- Flat Center Panel
- Full Overlay
- Profiled Slab Drawer Front

- See chart to the right for 5-piece drawer front dimensions representative of a 9" wide base cabinet when specifying decorative hardware.
- A heat shield is required to separate PureStyle™ doors, drawer fronts, overlay fillers, and all laminate products from heat producing units to be in compliance with cabinet warranty.

5-Piece Drawer Front Dimensions	
Drawer Front Width	8 1/2"
Drawer Front Height	6 1/4"
Panel Flat Width	3 1/2"
Panel Flat Height	1 1/4"

DOOR STYLES

DOOR STYLES

Berkley PO

	Cherry	Maple	Oak	Laminate	Painted Hardwood	PureStyle™
Price Point	—	6	—	—	6	4

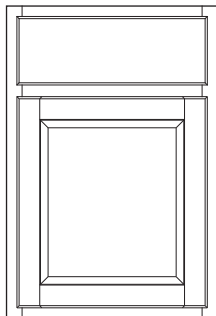

Base (Wood Species)

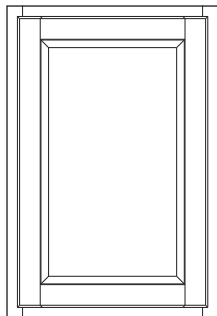

Wall (Wood Species)

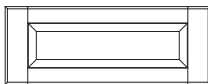

Optional Drawer Front:
Flat 5-piece (DFF5PC)

Decorative Door Options

CG	MD	MFO
•	•	

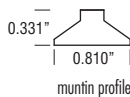

muntin profile

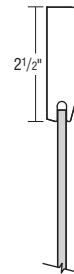

Wood Species door profile



Wood Species drawer front profile

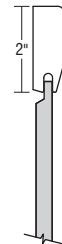

Wood Species optional drawer front profile (top and bottom)

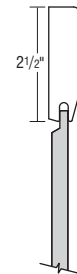

Wood Species optional drawer front profile (sides)

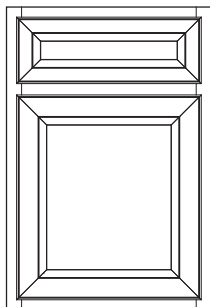

Base (PureStyle™)

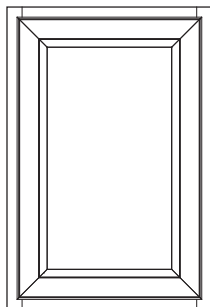

Wall (PureStyle™)

Decorative Door Options

CG	MD	MFO
•	•	

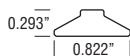

muntin profile



PureStyle™ door profile

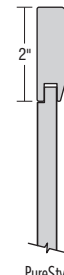

PureStyle™ drawer front profile

- Flat Center Panel
- Partial Overlay
- Profiled Slab Drawer Front

- See chart to the right for 5-piece drawer front dimensions representative of a 9" wide base cabinet when specifying decorative hardware.
- A heat shield is required to separate PureStyle™ doors, drawer fronts, overlay fillers, and all laminate products from heat producing units to be in compliance with cabinet warranty.

5-Piece Drawer Front Dimensions	
Drawer Front Width	7"
Drawer Front Height	5 1/2"
Panel Flat Width	2"*
Panel Flat Height	1 1/2"

*PureStyle DFF5PC Panel Flat Width is 3".

DOOR STYLES

Brawny FO

	Cherry	Maple	Oak	Laminate	Painted Hardwood	PureStyle™
Price Point	9	7	—	—	7	5

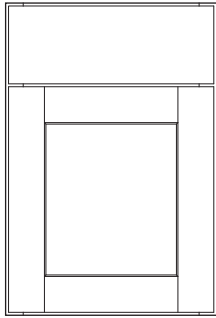

Base (Wood Species)

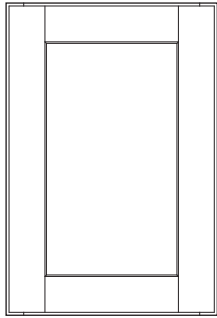

Wall (Wood Species)

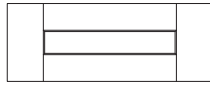

Optional Drawer Front:
Flat 5-piece (DFF5PC)
(Wood Species)

Decorative Door Options

CG	MD	MFO
•	•	•

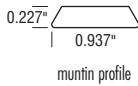

muntin profile

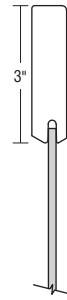

Wood Species door profile



Wood Species drawer front profile

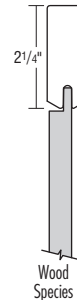

Wood Species optional drawer front profile (top and bottom)

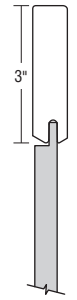

Wood Species optional drawer front profile (sides and 10"+)

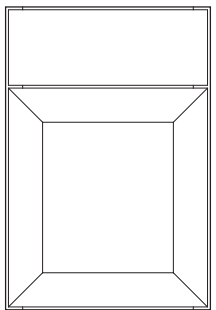

Base (PureStyle™)

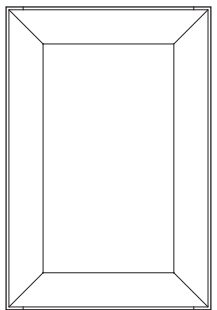

Wall (PureStyle™)

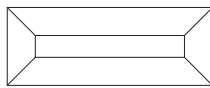

Optional Drawer Front:
Flat 5-piece (DFF5PC)
(PureStyle™)

Decorative Door Options

CG	MD	MFO
•	•	•

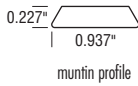

muntin profile

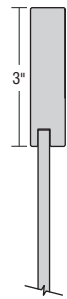

PureStyle™ door profile



PureStyle™ drawer front profile

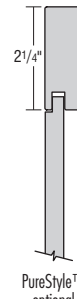

PureStyle™ optional drawer front profile

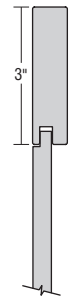

PureStyle™ optional drawer front profile 10"+

- Veneer Flat Panel
- Full Overlay
- Slab Drawer Front

- See chart to the right for 5-piece drawer front dimensions representative of a 9" wide base cabinet when specifying decorative hardware.
- A heat shield is required to separate PureStyle™ doors, drawer fronts, overlay fillers, and all laminate products from heat producing units to be in compliance with cabinet warranty.

5-Piece Drawer Front Dimensions	
Drawer Front Width	8 1/2"
Drawer Front Height	6 1/4"
Panel Flat Width	2 1/2"
Panel Flat Height	1 3/4"

*PureStyle DFF5PC Panel Flat Width is 4".

DOOR STYLES

Dapper FO

	Cherry	Maple	Oak	Laminate	Painted Hardwood	PureStyle™
Price Point	9	7	6	—	7	7

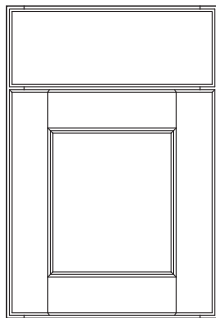

Base (Wood Species)

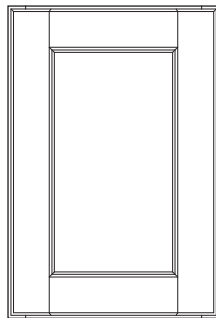

Wall (Wood Species)

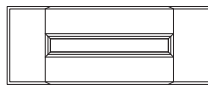

Optional Drawer Front:
Flat 5-piece (DFF5PC)

Decorative Door Options

CG	MD	MFO
•	•	•

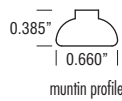

muntin profile

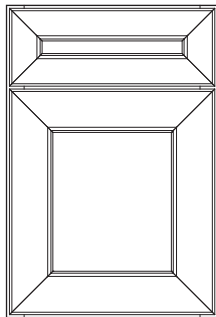

Base (PureStyle™)

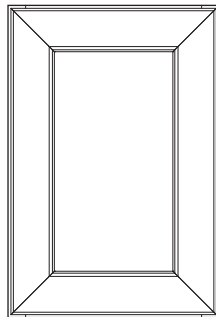

Wall (PureStyle™)

Decorative Door Options

CG	MD	MFO
•	•	•

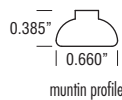

muntin profile

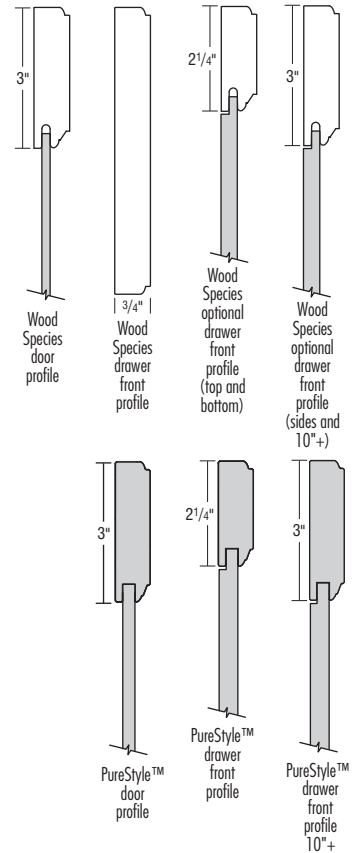

- Veneer Flat Panel
- Full Overlay
- Profiled Slab Drawer Front (Wood)
- 5-piece Drawer Front Mitered to Match Door (PureStyle™).
- See chart to the right for 5-piece drawer front dimensions representative of a 9" wide base cabinet when specifying decorative hardware.
- A heat shield is required to separate PureStyle™ doors, drawer fronts, overlay fillers, and all laminate products from heat producing units to be in compliance with cabinet warranty.

Special Notes:

- On W3D cabinets, Dapper FO PureStyle™ top slab drawer front will be painted hardwood.
- On UCD/UCDS/UCDT cabinets, Dapper FO PureStyle™ slab drawer front will be painted hardwood.
- On BBCPO_OL, WBCPO_OL, OL_OL, and OL_MFO SKUs, Dapper FO PureStyle™ overlays will be painted hardwood.
- On B6FH L or R cabinets, Dapper FO PureStyle™ doors will be painted hardwood.

5-Piece Drawer Front Dimensions	
Drawer Front Width	8 1/2"
Drawer Front Height	6 1/4"
Panel Flat Width	2 1/2"*
Panel Flat Height	1 3/4"

*PureStyle DFF5PC Panel Flat Width is 4".

DOOR STYLES

Detailed FO

	Cherry	Maple	Oak	Laminate	Painted Hardwood	PureStyle™
Price Point	9	7	—	—	7	—

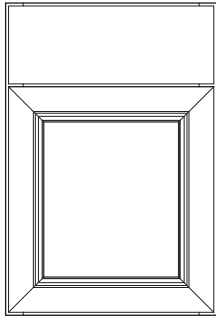

Base

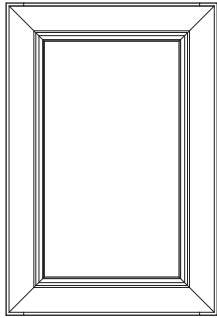

Wall

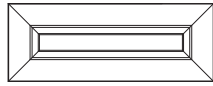

Optional Drawer Front:
Flat 5-piece (DFF5PC)

Decorative Door Options

CG	MD	MFO
•	•	•

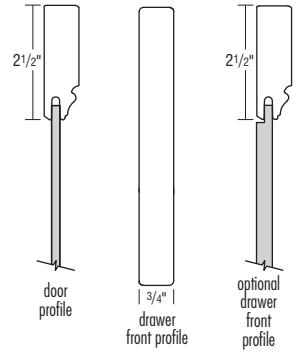
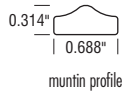

- Veneer Flat Panel Mitered Door
- Full Overlay
- Slab Drawer Front

- See chart to the right for 5-piece drawer front dimensions representative of a 9" wide base cabinet when specifying decorative hardware.

5-Piece Drawer Front Dimensions

Drawer Front Width	8 1/2"
Drawer Front Height	6 1/4"
Panel Flat Width	3 1/2"
Panel Flat Height	1 1/4"

Detailed PO

	Cherry	Maple	Oak	Laminate	Painted Hardwood	PureStyle™
Price Point	8	6	—	—	6	—

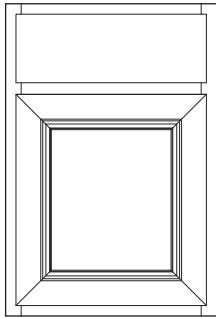

Base

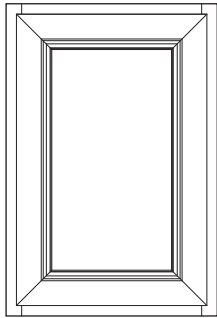

Wall

Decorative Door Options

CG	MD	MFO
•	•	

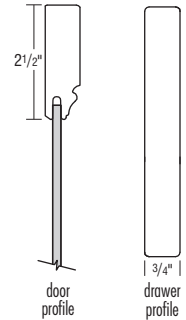
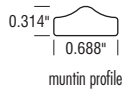

- Veneer Flat Panel Mitered Door

- Partial Overlay
- Slab Drawer Front

Henri

	Cherry	Maple	Oak	Laminate	Painted Hardwood	PureStyle™
Price Point	—	4	—	—	4	—

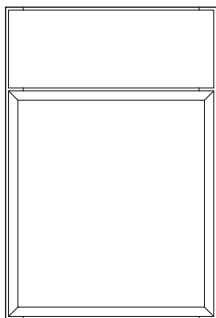

Base

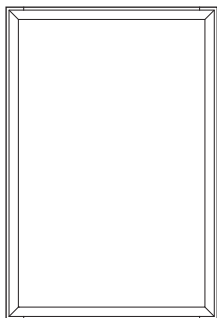

Wall

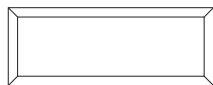

Optional Drawer Front:
Flat 5-piece (DFF5PC)

Decorative Door Options

CG	MD	MFO
		•

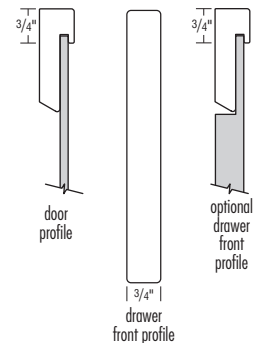

- Veneer Flat Panel
- Full Overlay
- Slab Drawer Front

- See chart to the right for 5-piece drawer front dimensions representative of a 9" wide base cabinet when specifying decorative hardware.

5-Piece Drawer Front Dimensions

Drawer Front Width	8 1/2"
Drawer Front Height	6 1/4"
Panel Flat Width	7"
Panel Flat Height	4 3/4"

F12

DOOR STYLES

DOOR STYLES

Perry FO

	Cherry	Maple	Oak	Laminate	Painted Hardwood	PureStyle™
Price Point	9	7	—	—	7	—

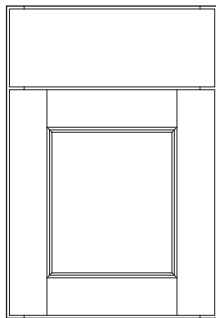

Base

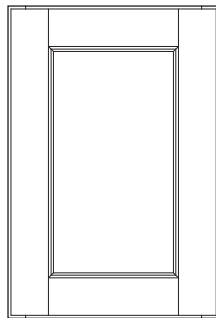

Wall

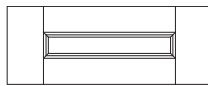

Optional Drawer Front:
Flat 5-Piece (DFF5PC)

Decorative Door Options

CG	MD	MFO
•	•	•

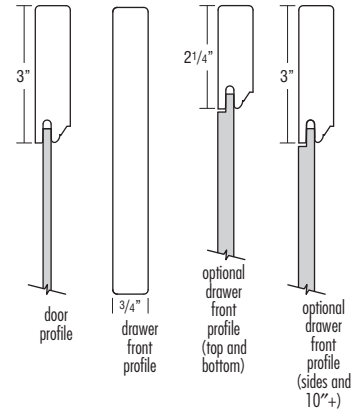
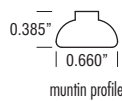

- Veneer Flat Panel
- Full Overlay
- Slab Drawer Front

- See chart to the right for 5-piece drawer front dimensions representative of a 9" wide base cabinet when specifying decorative hardware.

5-Piece Drawer Front Dimensions

Drawer Front Width	8 1/2"
Drawer Front Height	6 1/4"
Panel Flat Width	2 1/2"
Panel Flat Height	1 3/4"

Simple FO

	Cherry	Maple	Oak	Laminate	Painted Hardwood	PureStyle™
Price Point	7	4	3	—	4	3

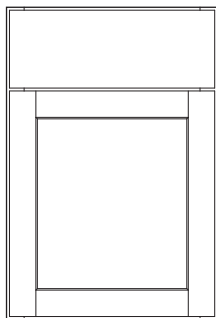

Base (Wood Species)

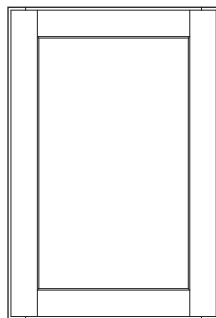

Wall (Wood Species)

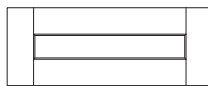

Optional Drawer Front:
Flat 5-piece (DFF5PC)
(Wood Species)

Decorative Door Options

CG	MD	MFO
•	•	•

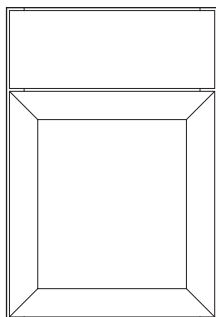
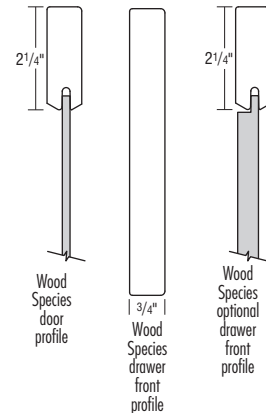
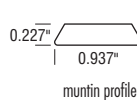

Base (PureStyle™)

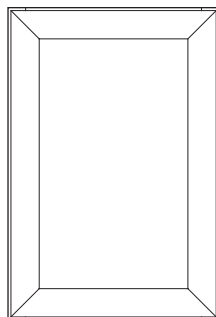

Wall (PureStyle™)

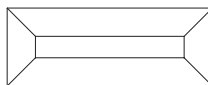

Optional Drawer Front:
Flat 5-piece (DFF5PC)
(PureStyle™)

Decorative Door Options

CG	MD	MFO
•	•	•

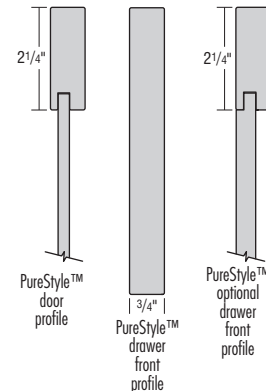
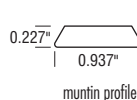

- Veneer Flat Panel
- Full Overlay
- Slab Drawer Front

- See chart to the right for 5-piece drawer front dimensions representative of a 9" wide base cabinet when specifying decorative hardware.
- A heat shield is required to separate PureStyle™ doors, drawer fronts, overlay fillers, and all laminate products from heat producing units to be in compliance with cabinet warranty.

5-Piece Drawer Front Dimensions

Drawer Front Width	8 1/2"
Drawer Front Height	6 1/4"
Panel Flat Width	4"
Panel Flat Height	1 3/4"

DOOR STYLES

Simple PO

	Cherry	Maple	Oak	Laminate	Painted Hardwood	PureStyle™
Price Point	6	3	2	—	3	2

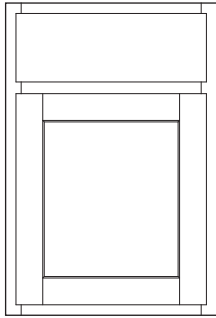

Base (Wood Species)

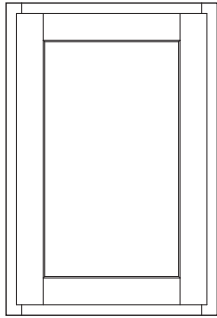

Wall (Wood Species)

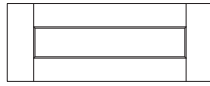

Optional Drawer Front:
Flat 5-piece (DFF5PC)
(Wood Species)

Decorative Door Options

CG	MD	MFO
•	•	

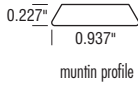

muntin profile

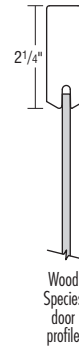

Wood Species door profile



Wood Species drawer front profile

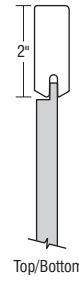

Top/Bottom

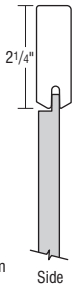

Side

Wood Species optional drawer front profile

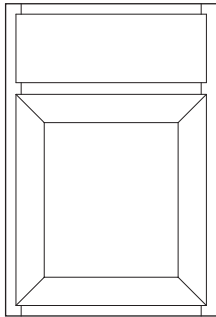

Base (PureStyle™)

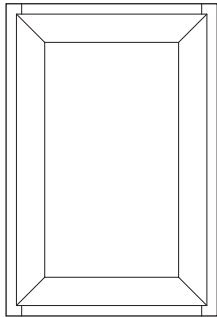

Wall (PureStyle™)

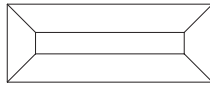

Optional Drawer Front:
Flat 5-piece (DFF5PC)
(PureStyle™)

Decorative Door Options

CG	MD	MFO
•	•	

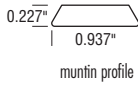

muntin profile

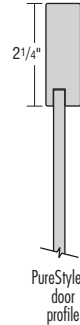

PureStyle™ door profile



PureStyle™ drawer front profile

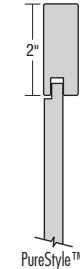

PureStyle™ optional drawer front profile

- Veneer Flat Panel
- Partial Overlay
- Slab Drawer Front

- See chart to the right for 5-piece drawer front dimensions representative of a 9" wide base cabinet when specifying decorative hardware.
- A heat shield is required to separate PureStyle™ doors, drawer fronts, overlay fillers, and all laminate products from heat producing units to be in compliance with cabinet warranty.

5-Piece Drawer Front Dimensions

Drawer Front Width	7"
Drawer Front Height	5 1/2"
Panel Flat Width	2 1/2"
Panel Flat Height	1 1/2"

*PureStyle DFF5PC Panel Flat Width is 3".

DOOR STYLES

Slab FO

	Cherry	Maple	Oak	Laminate	Painted Hardwood	PureStyle™
Price Point	7	4	—	3	4	—

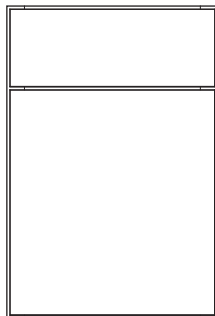

Base

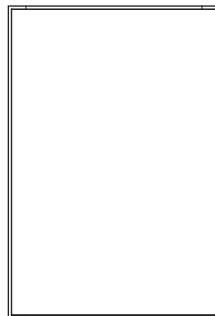

Wall

Decorative Door Options

CG	MD	MFO
•	•	•



door profile
| 3/4" |



drawer front profile
| 3/4" |

- Veneer Face and Back
- Veneer Edging on all Edges
- Furniture Board Core
- Vertical Grain Pattern
- Slab Door and Drawer Front
- Full Overlay

- When Slab FO is selected in Painted Hardwood, the doors and drawer fronts will be constructed of medium density fiberboard (MDF) or high density fiberboard (HDF).
- A heat shield is required to separate laminate doors, drawer fronts, overlay fillers, and all laminate products from heat producing units to be in compliance with cabinet warranty.

Special Notes:

- NSCH and NSCFB modifications are not available on this door style.
- VWM2430 L or R is not available on this door style.

Slim FO

	Cherry	Maple	Oak	Laminate	Painted Hardwood	PureStyle™
Price Point	6	3	2	—	3	—

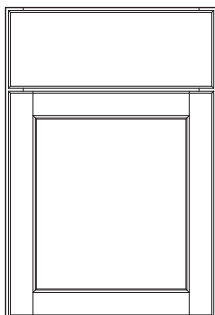

Base

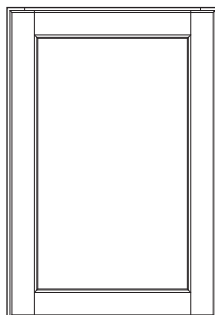

Wall

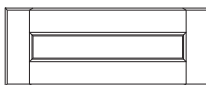

Optional Drawer Front:
Flat 5-piece (DFF5PC)

Decorative Door Options

CG	MD	MFO
•	•	•

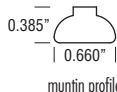

0.385" | 0.660" |
muntin profile

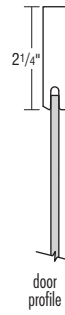

2 1/4" |
door profile



2 1/4" |
drawer front profile
| 3/4" |

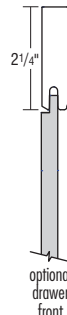

2 1/4" |
optional drawer front profile

- Veneer Flat Panel
- Full Overlay
- Profiled Slab Drawer Front

- See chart to the right for 5-piece drawer front dimensions representative of a 9" wide base cabinet when specifying decorative hardware.

5-Piece Drawer Front Dimensions	
Drawer Front Width	8 1/2"
Drawer Front Height	6 1/4"
Panel Flat Width	4"
Panel Flat Height	1 3/4"

DOOR STYLES

Slim PO

	Cherry	Maple	Oak	Laminate	Painted Hardwood	PureStyle™
Price Point	5	2	1	—	2	—

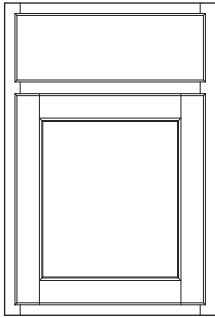

Base

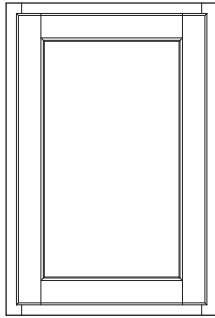

Wall

Decorative Door Options

CG	MD	MFO
•	•	

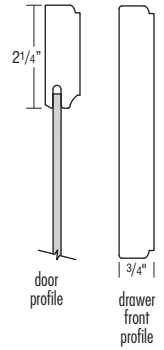
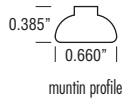

- Veneer Flat Panel
- Partial Overlay
- Profiled Slab Drawer Front

Stevenson FO

	Cherry	Maple	Oak	Laminate	Painted Hardwood	PureStyle™
Price Point	11	10	—	—	10	—

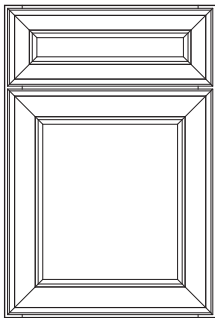

Base

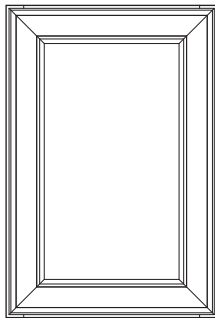

Wall

Decorative Door Options

CG	MD	MFO
•	•	•

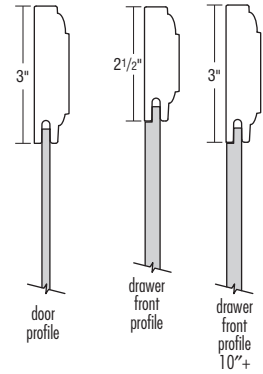
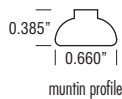

- Veneer Flat Panel Mitered Door
- Full Overlay
- 5-piece Drawer Front Mitered to Match Door
- See chart to the right for 5-piece drawer front dimensions representative of a 9" wide base cabinet when specifying decorative hardware.

5-Piece Drawer Front Dimensions	
Drawer Front Width	8 1/2"
Drawer Front Height	6 1/4"
Panel Flat Width	3 1/2"
Panel Flat Height	1 1/4"

F16

DOOR STYLES

DOOR STYLES

Traditional FO

	Cherry	Maple	Oak	Laminate	Painted Hardwood	PureStyle™
Price Point	8	6	4	—	6	—

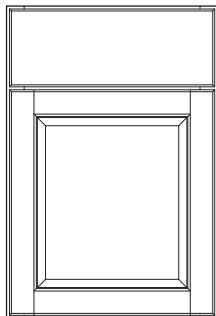

Base

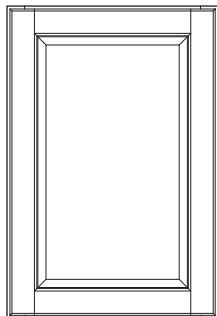

Wall

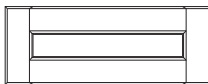

Optional Drawer Front:
Flat 5-piece (DFF5PC)

Decorative Door Options

CG	MD	MFO
•	•	•

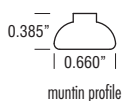

muntin profile

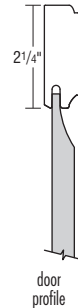

door profile



3/4" |
drawer front profile

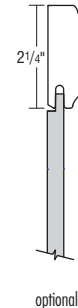

2 1/4" |
optional drawer front profile

- Veneer Raised Panel
- Full Overlay
- Profiled Slab Drawer Front

- See chart to the right for 5-piece drawer front dimensions representative of a 9" wide base cabinet when specifying decorative hardware.

5-Piece Drawer Front Dimensions	
Drawer Front Width	8 1/2"
Drawer Front Height	6 1/4"
Panel Flat Width	4"
Panel Flat Height	1 3/4"

Traditional PO

	Cherry	Maple	Oak	Laminate	Painted Hardwood	PureStyle™
Price Point	7	5	3	—	5	—

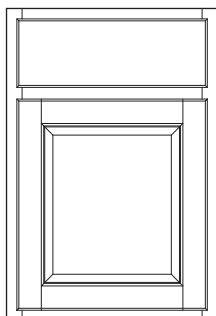

Base

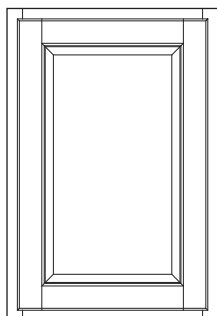

Wall

Decorative Door Options

CG	MD	MFO
•	•	•

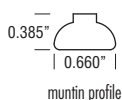

muntin profile



door profile



3/4" |
drawer front profile

- Veneer Flat Panel
- Partial Overlay
- Profiled Slab Drawer Front

12-STEP FINISHING PROCESS

- 1. Wood Selection** – The selection of the finest woods is the essential first step of the 12-step finishing process.
- 2. Sanded to Perfection** – Our sanding utilizes a fine grit paper, both with and against the wood grain. This process is completed on a vacuum table, allowing for a wood surface that is free of dust particles.
- 3. Achieving Natural Wood Tone** – Toner is applied to selected finishes, enhancing the naturalistic wood appearance.
- 4. Stain Application** – A hand-sprayed deep saturating stain is evenly applied to all surfaces for even coverage on all profiles. On multi-step stains and glaze finishes, some non-facing surfaces (such as backs of doors, backs of panels, and matching veneer interiors) may not receive all steps noted. The resulting finish will be complementary and similar in color and have the same catalyzed top coat and cure, but may not result in the same color depth as facing surfaces.
- 5. Removal of Excess Stain** – The wood is hand-wiped to remove excess stain, emphasizing the cabinet's natural wood grain.
- 6. Catalyzed Sealer** – A tough, clear, catalyzed sealer is hand-sprayed on to protect the grain from moisture.
- 7. Drying Process** – For added durability, the sealed wood is oven cured to lock in the beauty of wood.
- 8. Hand-Sanded** – To achieve an ultra-smooth finish, we hand-sand the material one last time.
- 9. Dust Removal** – The resulting loose dust particles are removed from the surface of the wood.
- 10. Catalyzed Top Coat** – A premium quality catalyzed top coat is applied to protect the wood from environmental elements.
- 11. Final Top Coat Cure** – The top coat is cured for a strong, beautiful finish.
- 12. Final Inspection** – This last inspection is very thorough, ensuring quality and beauty. Our gift to you is that every cabinet is crafted with care.

CHARACTERISTICS OF GLAZING/PAINT

Penned Glazes

A professional layer of glaze can add another layer of beauty to your cabinets. Our hand-detailed penned glaze application adds depth and dimension to your cabinet's appearance by highlighting the profile of your door style choice.

- Hand-detailed penned glazing will leave a consistent, "penned" appearance around the door profile, and will not change the overall finish or paint base color.
- You should expect the result to yield a subtle to dramatic look based on the complexity of a cabinet door's design.
- Printed materials and online, electronic presentations can only do so much. It's important to both see and touch actual finished samples to ensure your satisfaction.

Characteristics of Paint

Paint may develop hairline cracks in the finish, most notable around the joints. This is a result of natural expansion and contraction of the genuine hardwoods used in the manufacturing of this product. Hairline cracks are not considered a defect in the cabinetry or finish.

FINISH AVAILABILITY

		CHERRY											MAPLE																									
		Penned Glaze	Matching Laminate Ends	Upcharge	Brawny FO	Dapper FO	Detailed FO	Detailed PO	Perry FO	Simple FO	Simple PO	Slab FO	Slim FO	Slim PO	Stevenson FO	Traditional FO	Traditional PO	Berkley FO	Berkley PO	Brawny FO	Dapper FO	Detailed FO	Detailed PO	Henri FO	Perry FO	Simple FO	Simple PO	Slab FO	Slim FO	Slim PO	Stevenson FO	Traditional FO	Traditional PO					
Stains	Buckskin	✓	✓		✓	✓	✓	✓	✓	✓	✓	✓	✓	✓	✓	✓	✓	✓	✓	✓	✓	✓	✓	✓	✓	✓	✓	✓	✓	✓	✓	✓	✓	✓	✓			
	Chocolate		✓		✓	✓	✓	✓	✓	✓	✓	✓	✓	✓	✓	✓	✓	✓	✓	✓	✓	✓	✓	✓	✓	✓	✓	✓	✓	✓	✓	✓	✓	✓	✓			
	Coastline 	✓	✓															✓	✓	✓	✓	✓	✓	✓	✓	✓	✓	✓	✓	✓	✓	✓	✓	✓	✓	✓		
	Colt	✓	✓		✓	✓	✓	✓	✓	✓	✓	✓	✓	✓	✓	✓	✓	✓	✓	✓	✓	✓	✓	✓	✓	✓	✓	✓	✓	✓	✓	✓	✓	✓	✓	✓	✓	
	Kanga	✓	✓		✓	✓	✓	✓	✓	✓	✓	✓	✓	✓	✓	✓	✓	✓	✓	✓	✓	✓	✓	✓	✓	✓	✓	✓	✓	✓	✓	✓	✓	✓	✓	✓	✓	
	Morel	✓	✓		✓	✓	✓	✓	✓	✓	✓	✓	✓	✓	✓	✓	✓	✓	✓	✓	✓	✓	✓	✓	✓	✓	✓	✓	✓	✓	✓	✓	✓	✓	✓	✓	✓	
	Natural	✓	✓															✓	✓	✓	✓	✓	✓	✓	✓	✓	✓	✓	✓	✓	✓	✓	✓	✓	✓	✓	✓	
	Sahara	✓	✓		✓	✓	✓	✓	✓	✓	✓	✓	✓	✓	✓	✓	✓	✓	✓	✓	✓	✓	✓	✓	✓	✓	✓	✓	✓	✓	✓	✓	✓	✓	✓	✓	✓	✓
	Thatch	✓	✓		✓	✓	✓	✓	✓	✓	✓	✓	✓	✓	✓	✓	✓	✓	✓	✓	✓	✓	✓	✓	✓	✓	✓	✓	✓	✓	✓	✓	✓	✓	✓	✓	✓	✓
	Titanium		✓		✓	✓	✓	✓	✓	✓	✓	✓	✓	✓	✓	✓	✓	✓	✓	✓	✓	✓	✓	✓	✓	✓	✓	✓	✓	✓	✓	✓	✓	✓	✓	✓	✓	✓
	Unfinished*			-5%	✓	✓	✓	✓	✓	✓	✓	✓	✓	✓	✓	✓	✓	✓	✓	✓	✓	✓	✓	✓	✓	✓	✓	✓	✓	✓	✓	✓	✓	✓	✓	✓	✓	✓
Penned Glazes on Stains	Amaretto Crème		✓	10%													✓	✓	✓	✓	✓	✓	✓	✓	✓	✓	✓	✓	✓	✓	✓	✓	✓	✓	✓	✓	✓	



*Requires APW or PLE upgrade. Discount of 5% applied to all applicable products. When cabinets are finished by an outside source, finish is not covered under warranty. Interiors of cabinets will be natural Maple laminate. For finishable interiors, MIP must be specified.

Cherry laminate components are intentionally slightly darker than cabinet facings at the time of manufacturing to compensate for the expected darkening of doors, drawer fronts, etc., as they are exposed to natural sunlight.

FINISH AVAILABILITY

		OAK								
		Matching Laminate Ends	Upcharge	Dapper FO	Simple FO	Simple PO	Slim FO	Slim PO	Traditional FO	Traditional PO
Stains	Buckskin	✓		✓	✓	✓	✓	✓	✓	✓
	Chocolate	✓		✓	✓	✓	✓	✓	✓	✓
	Coastline 	✓		✓	✓	✓	✓	✓	✓	✓
	Colt	✓		✓	✓	✓	✓	✓	✓	✓
	Kanga	✓		✓	✓	✓	✓	✓	✓	✓
	Morel	✓		✓	✓	✓	✓	✓	✓	✓
	Natural	✓		✓	✓	✓	✓	✓	✓	✓
	Sahara	✓		✓	✓	✓	✓	✓	✓	✓
	Thatch	✓		✓	✓	✓	✓	✓	✓	✓
	Titanium	✓		✓	✓	✓	✓	✓	✓	✓
	Unfinished*		-5%	✓	✓	✓	✓	✓	✓	✓

*Requires APW or PLE upgrade. Discount of 5% applied to all applicable products. When cabinets are finished by an outside source, finish is not covered under warranty. Interiors of cabinets will be natural Maple laminate. For finishable interiors, MIP must be specified.

FINISH AVAILABILITY																				
		PAINTED HARDWOOD																		
		Penned Glaze	Matching Laminate Ends	Upcharge	Berkley FO	Berkley PO	Brawny FO	Dapper FO	Detailed FO	Detailed PO	Henri FO 	Perry FO	Simple FO	Simple PO	Slab FO	Slim FO	Slim PO	Stevenson FO	Traditional FO	Traditional PO
Paints 	Black		✓		✓	✓	✓	✓	✓	✓	✓	✓	✓	✓	✓	✓	✓	✓	✓	✓
	Cloud	✓	✓		✓	✓	✓	✓	✓	✓	✓	✓	✓	✓	✓	✓	✓	✓	✓	✓
	Coconut	✓	✓		✓	✓	✓	✓	✓	✓	✓	✓	✓	✓	✓	✓	✓	✓	✓	✓
	Icy Avalanche	✓	✓		✓	✓	✓	✓	✓	✓	✓	✓	✓	✓	✓	✓	✓	✓	✓	✓
	Maritime		✓		✓	✓	✓	✓	✓	✓	✓	✓	✓	✓	✓	✓	✓	✓	✓	✓
	Moonstone		✓		✓	✓	✓	✓	✓	✓	✓	✓	✓	✓	✓	✓	✓	✓	✓	✓
	Naval		✓		✓	✓	✓	✓	✓	✓	✓	✓	✓	✓	✓	✓	✓	✓	✓	✓
	Retreat	✓	✓		✓	✓	✓	✓	✓	✓	✓	✓	✓	✓	✓	✓	✓	✓	✓	✓
	Steam	✓	✓		✓	✓	✓	✓	✓	✓	✓	✓	✓	✓	✓	✓	✓	✓	✓	✓
	White	✓	✓		✓	✓	✓	✓	✓	✓	✓	✓	✓	✓	✓	✓	✓	✓	✓	✓
Penned Glazes on Paints 	Amaretto Crème		✓	10%	✓	✓	✓	✓	✓	✓	✓	✓	✓	✓		✓	✓	✓	✓	✓
	Grey Stone		✓	10%	✓	✓	✓	✓	✓	✓	✓	✓	✓	✓		✓	✓	✓	✓	✓

Painted Hardwood finishes combine hardwoods and engineered materials including solid-wood, engineered materials — such as medium density fiberboard (MDF) and high density fiberboard (HDF) — and similar composite materials providing a smoother surface for painting and superior stability, consistency, and durability.
 Signed finish agreement required.

FINISH AVAILABILITY												
			LAMINATE			PURESTYLE™ LAMINATE						
		Matching Laminate Ends	Upcharge	Slab FO			Berkley FO	Berkley PO	Brawny FO	Dapper FO	Simple FO	Simple PO
Laminate Finishes	Cloud	✓		✓			✓	✓	✓	✓	✓	✓
	Coconut	✓		✓			✓	✓	✓	✓	✓	✓
	Icy Avalanche	✓		✓			✓	✓	✓	✓	✓	✓
	Maritime	✓		✓			✓	✓	✓	✓	✓	✓
	Moonstone	✓		✓			✓	✓	✓	✓	✓	✓
	Steam	✓		✓			✓	✓	✓	✓	✓	✓
	White	✓		✓			✓	✓	✓	✓	✓	✓

PAINTED COLOR PALETTE			
	OPTION NAME	DESCRIPTION/LIMITATIONS	UPCHARGE**
Paints	Black	True black.	N/A
	Cloud	Medium gray.	N/A
	Coconut	Creamy off white.	N/A
	Icy Avalanche	Cool white with gray undertones.	N/A
	Maritime	Dark navy with gray/green undertones.	N/A
	Moonstone	Cool dark gray.	N/A
	Naval	Classic navy.	N/A
	Retreat	Medium gray color with blue green undertones	N/A
	Steam	Pale, milky white.	N/A
	White	Bright, pure white.	N/A
Penned Glazes	Amaretto Crème	A dark spicy brown glaze that helps define any profile with high contrast.	Cabinet list + 10%
	Grey Stone	A grey glaze that helps define any profile with high contrast	Cabinet list + 10%

**Cabinet list includes cabinet price plus any modifications except APW and PLE.

CONSTRUCTION FEATURES

	STANDARD CONSTRUCTION	PLYWOOD ENDS*	ALL-PLYWOOD CONSTRUCTION*
Doors & Drawer Fronts	See Door Style section for door and drawer front configuration and construction details.		
Face Frames	3/4" solid hardwood.		
I-beam Braces	3/8" furniture board dadoed into face frame, end panels and back panels.		3/8" plywood dadoed into face frame, end panels and back panels.
Cabinet Sides	1/2" furniture board with Natural Maple laminate interiors. Exteriors are laminate that match the color of the face frame.	1/2" unfinished veneer plywood with Natural Maple interiors.	1/2" unfinished veneer plywood with Natural Maple interiors.
Cabinet Tops & Bottoms (Wall & Tall)	3/8" furniture board with natural Maple laminate interior and exterior surfaces.		3/8" plywood with natural Maple laminate interior and exterior surfaces.
Cabinet Bottoms (Base & Vanity)	3/8" furniture board with natural Maple laminate interior surface.		3/8" plywood with natural Maple laminate interior surface.
Cabinet Backs	3/8" furniture board with natural Maple laminate interior. Base cabinets have 3mm system holes for easy drawer and roll tray installation.		3/8" plywood with natural Maple laminate interior. Base cabinets have 3mm system holes for easy drawer and roll tray installation.
Adjustable Shelves	3/4" furniture board with natural Maple laminate to match interiors. Shelves are adjustable in wall and base cabinets unless otherwise noted.		3/4" plywood laminated to match interiors. Shelves are adjustable in wall and base cabinets unless otherwise noted.
Finish	Multi-step finishing process where the finished components are sanded, stained, and sealed before a catalyzed top coat is applied.		
Hinges	Soft-close fully concealed, integrated cup hinge with self-closing feature; 6-way adjustable. Hinge features deactivation option. Some cabinets utilize a 170° or 107° 4-way adjustable hinge. See page 156 for details. NSCH mod: Fully concealed cup hinge; 6-way adjustable and self-closing.		
Drawers	Standard: Double fully concealed, roller bearing, self-aligning, full extension guide with soft-close self-closing mechanism and fast clip removal system. Soft-close engages when the drawer is approximately 2" from closing, applying resistance to the self-closing mechanism. Four-sided clear coated, solid hardwood drawer box with dovetailed construction. All guides have a 75 lb. weight capacity. NSCFB mod: 1/2" natural Maple laminated furniture board. Drawer bottom is 3/8" natural Maple furniture board. Features 3/4 extension side-mounted, epoxy coated guides. All guides have a 75 lb. weight capacity.		
Roll Trays	Standard: Double fully concealed, roller bearing, self-aligning, full extension guide with soft-close self-closing mechanism and fast clip removal system. Soft-close engages when the roll tray is approximately 2" from closing, applying resistance to the self-closing mechanism. Four-sided clear coated, solid hardwood roll tray with dovetailed construction. All guides have a 75 lb. weight capacity. NSCFB mod: 1/2" natural Maple laminated furniture board. Roll tray bottom is 3/8" natural Maple furniture board. Features 3/4 extension side-mounted, epoxy coated guides. All guides have a 75 lb. weight capacity.		
Toekick	Unfinished furniture board toekick to allow application of finished toeboard materials. A variety of laminate and wood toeboard skins and baseboard mouldings available in 8' lengths; see ACCESSORIES section.	3/8" Unfinished plywood toekick to allow application of finished toeboard materials. Toeboard skins and baseboard mouldings available in 8' lengths; see ACCESSORIES section.	
Interior Cabinet Components	A few interior components are manufactured from laminated furniture board because they provide for the most durable, aesthetic application.		

*All-plywood components meet ANSI/HPVA HP-1 standards and may contain MDF or particleboard.

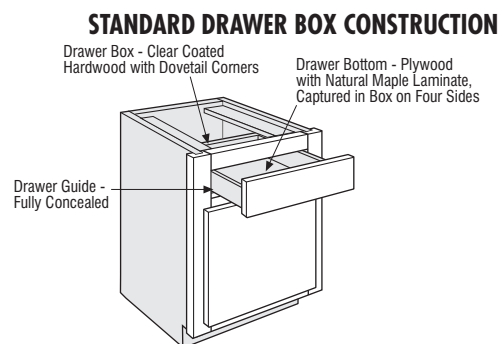
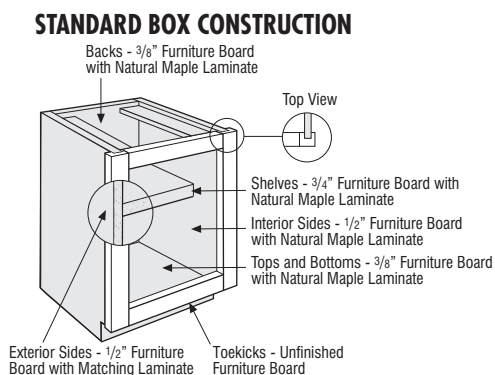

MODIFICATION/UPGRADE COMPATIBILITY CHART

MODIFICATION/ UPGRADE		APW	PLE	DFFSPC	MFO	NSCH	NSCFB	AUTHB	AUTHL	AUTHR	FB	FPEB	MIP	CBO	CCO	CFP	CND	ID	RD	FD	RT	ADDTK	FTK	FTKAV	FTKFV	RECTKALL	RECTKBK	RECTKL	RECTKR	VTK	CFNTO	CFRMO	P	CG	MD		
Construction Upgrades (page 3)	APW - All-plywood Construction	✓		✓	✓	✓	✓	✓	✓	✓	✓	✓		✓	✓	✓	✓	✓	✓	✓	✓	✓	✓	✓	✓	✓	✓	✓	✓	✓	✓	✓	✓	✓	✓		
	PLE - Plywood Ends		✓	✓	✓	✓					✓			✓	✓	✓	✓	✓	✓	✓	✓	✓	✓	✓	✓	✓	✓	✓	✓	✓	✓	✓	✓	✓	✓		
Drawer Front and Door Options (page 4)	DFFSPC - Drawer Front Flat 5-piece	✓	✓		✓	✓	✓	✓	✓	✓	✓	✓				✓	✓	✓	✓	✓	✓	✓	✓	✓	✓	✓	✓	✓	✓	✓	✓	✓	✓	✓	✓		
	MFO - Modified Full Overlay	✓	✓	✓		✓	✓	✓	✓	✓	✓	✓					✓	✓	✓	✓	✓	✓	✓	✓	✓	✓	✓	✓	✓	✓	✓	✓	✓	✓	✓		
Non Soft-close Options (page 5)	NSCH - Non Soft-close Door Hinges	✓	✓	✓	✓		✓	✓	✓	✓	✓	✓				✓	✓	✓	✓	✓	✓	✓	✓	✓	✓	✓	✓	✓	✓	✓	✓	✓	✓	✓	✓		
	NSCFB - Non Soft-close Guides & Furniture Board Drawers and Roll Trays	✓	✓	✓	✓		✓	✓	✓	✓	✓	✓		✓			✓	✓	✓	✓	✓	✓	✓	✓	✓	✓	✓	✓	✓	✓	✓	✓	✓	✓	✓		
End Panel Modifications (page 6)	AUTHB - Authentic End Both	✓	✓	✓	✓	✓							✓	✓	✓	✓	✓	✓	✓	✓	✓	✓	✓	✓	✓	✓	✓	✓	✓	✓	✓	✓	✓	✓	✓		
	AUTHL - Authentic End Left	✓	✓	✓	✓	✓							✓	✓	✓	✓	✓	✓	✓	✓	✓	✓	✓	✓	✓	✓	✓	✓	✓	✓	✓	✓	✓	✓	✓		
	AUTHR - Authentic End Right	✓	✓	✓	✓	✓							✓	✓	✓	✓	✓	✓	✓	✓	✓	✓	✓	✓	✓	✓	✓	✓	✓	✓	✓	✓	✓	✓	✓	✓	
	FB - Finished Ends	✓	✓	✓	✓	✓							✓	✓	✓	✓	✓	✓	✓	✓	✓	✓	✓	✓	✓	✓	✓	✓	✓	✓	✓	✓	✓	✓	✓	✓	
	FPEB - Furniture Finished Plywood End Panels	✓	✓	✓	✓	✓						✓	✓	✓	✓	✓	✓	✓	✓	✓	✓	✓	✓	✓	✓	✓	✓	✓	✓	✓	✓	✓	✓	✓	✓	✓	
Finish Modification (page 7)	MIP - Matching Interior Plywood		✓	✓	✓	✓	✓	✓	✓	✓	✓	✓		✓	✓	✓	✓	✓	✓	✓	✓	✓	✓	✓	✓	✓	✓	✓	✓	✓	✓	✓	✓	✓	✓		
Box Modifications (pages 8-9)	CBO - Cabinet Box Only	✓	✓			✓	✓	✓	✓	✓	✓	✓		✓	✓	✓	✓	✓	✓	✓	✓	✓	✓	✓	✓	✓	✓	✓	✓	✓	✓	✓	✓	✓	✓	✓	
	CCO - Cabinet Case Only	✓	✓				✓	✓	✓	✓	✓	✓		✓	✓	✓	✓	✓	✓	✓	✓	✓	✓	✓	✓	✓	✓	✓	✓	✓	✓	✓	✓	✓	✓	✓	
	CFP - Cabinet False Panel	✓	✓	✓		✓	✓	✓	✓	✓	✓	✓		✓	✓	✓	✓	✓	✓	✓	✓	✓	✓	✓	✓	✓	✓	✓	✓	✓	✓	✓	✓	✓	✓	✓	✓
	CND - Cabinet with No Door, with Drawer	✓	✓	✓		✓	✓	✓	✓	✓	✓	✓		✓	✓	✓	✓	✓	✓	✓	✓	✓	✓	✓	✓	✓	✓	✓	✓	✓	✓	✓	✓	✓	✓	✓	✓
	ID - Increased Depth	✓	✓	✓	✓	✓	✓	✓	✓	✓	✓	✓	✓	✓	✓	✓	✓	✓	✓	✓	✓	✓	✓	✓	✓	✓	✓	✓	✓	✓	✓	✓	✓	✓	✓	✓	✓
	RD - Reduced Depth	✓	✓	✓	✓	✓	✓	✓	✓	✓	✓	✓	✓	✓	✓	✓	✓	✓	✓	✓	✓	✓	✓	✓	✓	✓	✓	✓	✓	✓	✓	✓	✓	✓	✓	✓	✓
Installed Interior Modifications (page 10)	FD - Full Depth Shelf	✓	✓	✓	✓	✓	✓	✓	✓	✓	✓	✓		✓	✓	✓	✓	✓	✓	✓	✓	✓	✓	✓	✓	✓	✓	✓	✓	✓	✓	✓	✓	✓	✓	✓	
	RT - Installed Roll Tray	✓	✓	✓	✓	✓	✓	✓	✓	✓	✓	✓		✓	✓	✓	✓	✓	✓	✓	✓	✓	✓	✓	✓	✓	✓	✓	✓	✓	✓	✓	✓	✓	✓	✓	
Toekick Modifications (pages 11-13)	ADDTK - Add Toekick	✓	✓	✓		✓	✓	✓	✓	✓	✓	✓	✓	✓	✓	✓	✓	✓	✓	✓	✓	✓	✓	✓	✓	✓	✓	✓	✓	✓	✓	✓	✓	✓	✓	✓	
	FTK - Flush Toekick	✓	✓	✓	✓	✓	✓	✓	✓	✓	✓	✓	✓	✓	✓	✓	✓	✓	✓	✓	✓	✓	✓	✓	✓	✓	✓	✓	✓	✓	✓	✓	✓	✓	✓	✓	
	FTKAV - Flush Toekick Arch	✓	✓	✓	✓	✓	✓	✓	✓	✓	✓	✓	✓	✓	✓	✓	✓	✓	✓	✓	✓	✓	✓	✓	✓	✓	✓	✓	✓	✓	✓	✓	✓	✓	✓	✓	✓
	FTKFV - Flush Toekick Furniture	✓	✓	✓	✓	✓	✓	✓	✓	✓	✓	✓	✓	✓	✓	✓	✓	✓	✓	✓	✓	✓	✓	✓	✓	✓	✓	✓	✓	✓	✓	✓	✓	✓	✓	✓	✓
	RECTKALL - Recessed Island Toekick	✓	✓	✓	✓	✓	✓	✓	✓	✓	✓	✓	✓	✓	✓	✓	✓	✓	✓	✓	✓	✓	✓	✓	✓	✓	✓	✓	✓	✓	✓	✓	✓	✓	✓	✓	✓
	RECTKBK - Recessed Toekick Back	✓	✓	✓	✓	✓	✓	✓	✓	✓	✓	✓	✓	✓	✓	✓	✓	✓	✓	✓	✓	✓	✓	✓	✓	✓	✓	✓	✓	✓	✓	✓	✓	✓	✓	✓	✓
	RECTKL - Recessed Toekick Left	✓	✓	✓	✓	✓	✓	✓	✓	✓	✓	✓	✓	✓	✓	✓	✓	✓	✓	✓	✓	✓	✓	✓	✓	✓	✓	✓	✓	✓	✓	✓	✓	✓	✓	✓	
	RECTKR - Recessed Toekick Right	✓	✓	✓	✓	✓	✓	✓	✓	✓	✓	✓	✓	✓	✓	✓	✓	✓	✓	✓	✓	✓	✓	✓	✓	✓	✓	✓	✓	✓	✓	✓	✓	✓	✓	✓	✓
	VTK - Void Toekick	✓	✓	✓	✓	✓	✓	✓	✓	✓	✓	✓	✓	✓	✓	✓	✓	✓	✓	✓	✓	✓	✓	✓	✓	✓	✓	✓	✓	✓	✓	✓	✓	✓	✓	✓	✓
Configuration Modifications (page 14)	CFNTO - Cabinet Front Only		✓	✓	✓																		✓	✓	✓									✓	✓		
	CFRMO - Cabinet Frame Only																						✓	✓	✓												
	P - Peninsula	✓	✓	✓	✓	✓	✓	✓	✓	✓	✓	✓	✓	✓	✓	✓	✓	✓	✓	✓	✓	✓	✓	✓	✓	✓	✓	✓	✓	✓	✓	✓	✓	✓	✓	✓	
Specialty Doors (pages 15-16)	CG - Cut-for-glass	✓	✓	✓	✓	✓	✓	✓	✓	✓	✓	✓	✓																					✓	✓		
	MD - Mullion Door	✓	✓	✓	✓	✓	✓	✓	✓	✓	✓	✓	✓																					✓	✓		

Orders for cabinets with non-compatible modifications will not be processed. Please contact customer service for more details.

✓Represents compatible modification(s) and upgrade(s).

CONSTRUCTION UPGRADES

See page 2 for modification compatibility.

OPTION NAME	APPLICABLE CABINET GROUP	DESCRIPTION/LIMITATIONS	PRICING
All-plywood Construction (APW)*	Most cabinets with sides	Replaces standard cabinet construction with plywood for 1/2" ends, 3/8" top, bottom, back, and 3/4" shelves. Exterior of the cabinet ends are unfinished.	Cabinet list + 12%
	Shelf kits	Replaces standard shelf construction with 3/4" laminated plywood shelves.	Shelves: List + 12%
Plywood Ends (PLE)*	Most cabinets with sides	Replaces standard cabinet ends with unfinished 1/2" plywood exterior ends.	Cabinet list + 6%

ALL-PLYWOOD CONSTRUCTION*

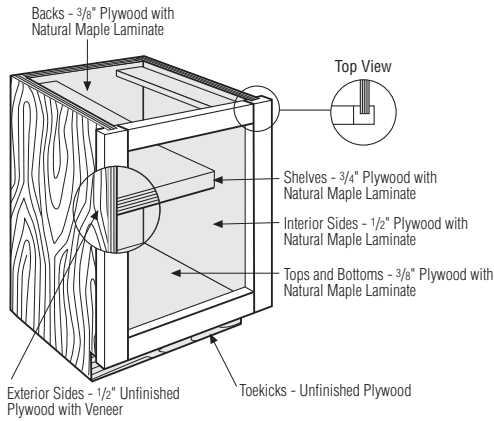

PLYWOOD ENDS*

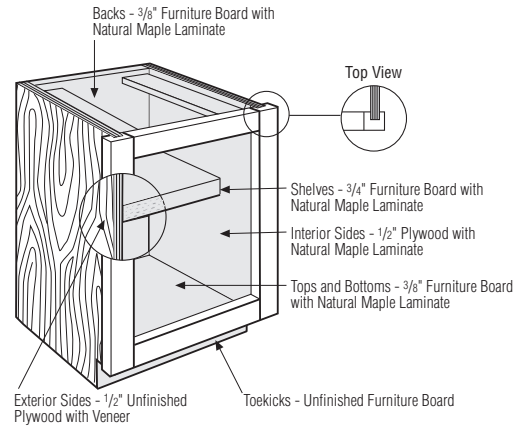

*All-plywood components meet ANSI/HPVA HP-1 standards and may contain MDF or particleboard.

DRAWER FRONT AND DOOR OPTIONS

See page 2 for modification compatibility.

OPTION NAME	APPLICABLE CABINET GROUP	DESCRIPTION/LIMITATIONS	PRICING
Drawer Front Flat 5-piece (DFF5PC)	Base, tall, and vanity cabinets on select door styles. See Door Style section for availability.	Replaces the standard drawer front with a 5-piece drawer front (see images with applicable door styles). <i>Must</i> upgrade all drawer fronts on a cabinet where applicable. Premium finish upcharges will apply where applicable. See door style sections for 5-piece drawer front dimensions when specifying decorative hardware.	\$102 list per drawer
Modified Full Overlay (MFO)	Full Overlay door styles of wall and tall cabinets	<p>Wall and Tall Cabinets: The door and drawer fronts overlay the frame, exposing 1/4" on the bottom rail and right and left stile. One full inch is exposed on the top rail of wall and tall cabinets. Typical units with a center stile expose 1/2" of that stile.</p> <p>Base Cabinets: The door and drawer fronts overlay the frame, exposing 1/4" on the top and bottom rails and right and left stiles of base cabinets. Typical base units with a center stile expose 1/2" of that stile.</p> <p>MFO modification allows for face mount moulding application.</p> <p>Overlay Fillers are available in MFO heights to align with doors, see page 124 for OL..MFO.</p> <p>Not compatible with Add Toekick modification.</p> <p>When Authentic End(s) are ordered in conjunction with Modified Full Overlay, the Authentic End door(s) will decrease to match the change in reveal.</p>	No Upcharge

MODIFIED FULL OVERLAY (MFO)

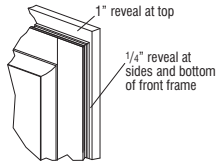

Modified Full Overlay (Wall and Tall)

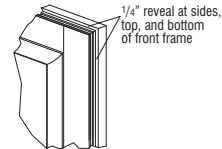

Modified Full Overlay (Base)

NON SOFT-CLOSE OPTIONS

See page 2 for modification compatibility.

OPTION NAME	APPLICABLE CABINET GROUP	DESCRIPTION/LIMITATIONS	PRICING
Non Soft-close Door Hinges (NSCH)	Most cabinets with doors	Replaces soft-close hinges with fully concealed cup hinge; 6-way adjustable and self-closing. Not available on Cherry wood species. Available on most door styles. See Door Style section for exception.	Deduct \$4 list per door
Non Soft-close Guides & Furniture Board Drawers and Roll Trays (NSCFB)	Most cabinets with drawers and/or roll trays	Replaces drawers and roll trays with 1/2" natural Maple laminated furniture board. Drawer bottom is 3/8" natural Maple furniture board. Replaces soft-close guides with side-mounted, epoxy coated guides. All guides have a 75 lb. weight capacity. Not available on Cherry wood species. Available on most door styles. See Door Style section for exception. Not compatible with RD12 and RD15.	Deduct \$32 list per drawer or roll tray

NON SOFT-CLOSE DOOR HINGES (NSCH)

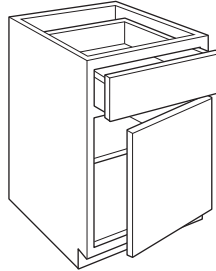

NON SOFT-CLOSE GUIDES & FURNITURE BOARD DRAWERS AND ROLL TRAYS (NSCFB)

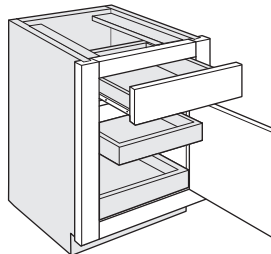

- Drawer Box / Roll Tray**
1/2" Furniture Board with Natural Maple Laminate
- Drawer / Roll Tray Bottom**
3/8" Furniture Board with Natural Maple Laminate
- Drawer Guide**
Side-mounted

END PANEL MODIFICATIONS

See page 2 for modification compatibility.

OPTION NAME	APPLICABLE CABINET GROUP	DESCRIPTION/LIMITATIONS	PRICING
Authentic Ends (AUTHB) (AUTHL) (AUTHR)	Most wall, base, tall, and vanity cabinets	<p>Modifies cabinet end panel(s) with applied decorative door(s) onto FPEB upgraded end panel(s). Includes FPEB modification — If AUTHL or AUTHR upgrades are specified, the opposite end panel is also FPEB.</p> <p>Available on most cabinets with depths of 12", 15", 18", 21", and 24".</p> <p>Tall mitered door styles and laminate door styles will feature one center panel, other door styles will feature two center panels.</p> <p>Office base cabinets (29" high) will have double door configuration when specified on 24" deep cabinets.</p>	<p>AUTHB Wall: \$748 list Base & Vanity: \$1,060 list Tall: \$2,530 list</p> <p>AUTHL/AUTHR Wall: \$374 list per side Base & Vanity: \$530 list per side Tall: \$1,265 list per side</p>
Finished Ends (FB)	Cabinets with All-plywood Construction or Plywood Ends modification; both ends will be finished	Creates a matching finished 1/2" veneer plywood exterior.	<p>Wall: \$74 list Base: \$121 list Tall: \$307 list</p>
Furniture Finished Plywood End Panels (FPEB)*	Most wall, base, tall, office, and vanity cabinets	Replaces standard cabinet ends with 3/4" finished veneer end panels to achieve a Furniture End appearance. Both exterior sides are finished. Matching interior (MIP) is available.	<p>Wall: \$165 list Base & Vanity: \$229 list Tall: \$395 list</p>

AUTHENTIC ENDS (AUTHB/AUTHL/AUTHR)

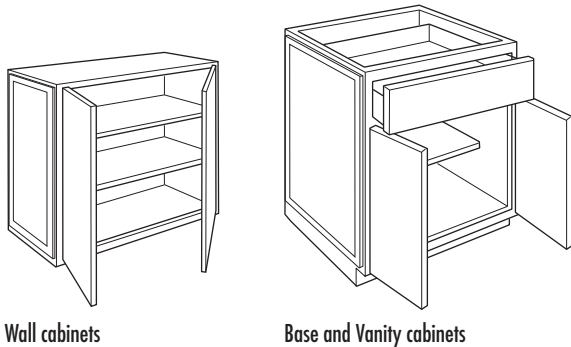

FURNITURE FINISHED PLYWOOD END PANELS CONSTRUCTION UPGRADE (FPEB)*

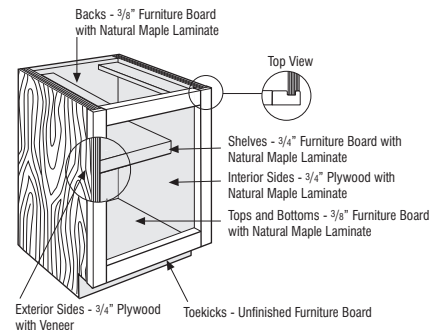



*All-plywood components meet ANSI/HPVA HP-1 standards and may contain MDF or particleboard.

FINISH MODIFICATION

See page 2 for modification compatibility.

OPTION NAME	APPLICABLE CABINET GROUP	DESCRIPTION/LIMITATIONS	PRICING
Matching Interior Plywood (MIP)*	Most cabinets; most end panels with fillers attached	<p>Modifies the cabinet interior and end panel exterior to matching finished veneer plywood. Cabinet top and bottom exterior on wall cabinets is also matching finished veneer plywood. Cabinet construction features 1/2" plywood* ends and 3/8" top, bottom, and back. Shelves are upgraded to full depth 3/4" veneered plywood*.</p> <p>Not available on open cabinets with standard matching interior.</p> <p>When a decorative door option is chosen in 20/20, Matching Interior Plywood (MIP) is a preselected option. If MIP is not desired, it can be deselected by choosing NOTMIP.</p> <p>Interior wood accessories feature a natural finish and will not match cabinet exterior.</p>	Cabinet list + 30%

MATCHING INTERIOR PLYWOOD (MIP)*

-  matching finished veneer
-  standard matching finished component
-  standard non-matching finished component

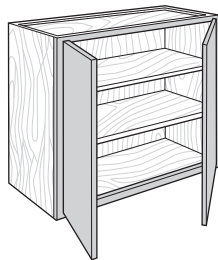

Wall cabinets

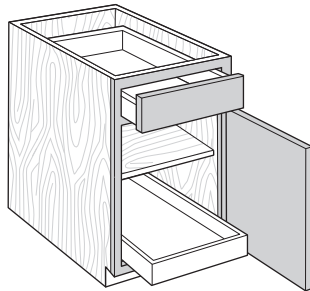

Base cabinets

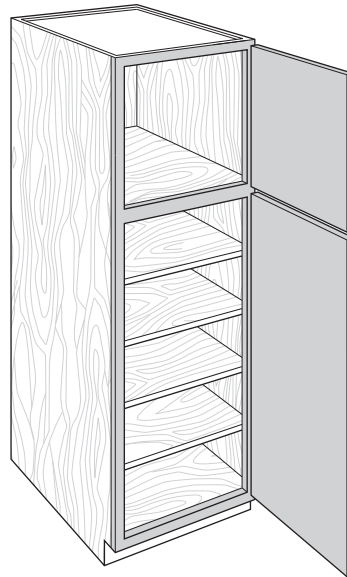

Tall cabinets

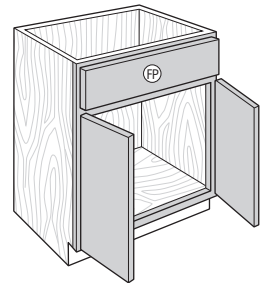

Vanity cabinets

*All-plywood components meet ANSI/HPVA HP-1 standards and may contain MDF or particleboard.

BOX MODIFICATIONS

See page 2 for modification compatibility.

OPTION NAME	APPLICABLE CABINET GROUP	DESCRIPTION/LIMITATIONS	PRICING
Cabinet Box Only (CBO)	Most wall, base, tall, and vanity cabinets	Removes doors, drawer fronts, and any accessory items attached to a door or drawer front. Drawer box and any interior components attached to the cabinet box will be included. Frames will not be drilled for hinges, but cabinet will have standard drilling for shelves and guides.	Cabinets without drawers: 85% of cabinet list Cabinets with drawers: 90% of cabinet list
Cabinet Case Only (CCO)	Most wall, base, tall, and vanity cabinets	Removes doors, drawer fronts, drawers, interior components, and mini touch-up kits. Frames will not be drilled for hinges, but cabinets will have standard drilling for shelves and guides.	85% of cabinet list
Cabinet False Panel (CFP)	Most base and vanity cabinets with a top drawer	Replaces top drawer with false panel. Not available with deep drawers.	No Upcharge
Cabinet with No Door, with Drawer (CND)	Most wall, base, tall, and vanity cabinets with door(s) and drawer(s)	Removes door(s). Complete drawer(s) with drawer front(s) and interior components remain in cabinet. Frames will not be drilled for hinges.	90% of cabinet list

CABINET BOX ONLY (CBO)

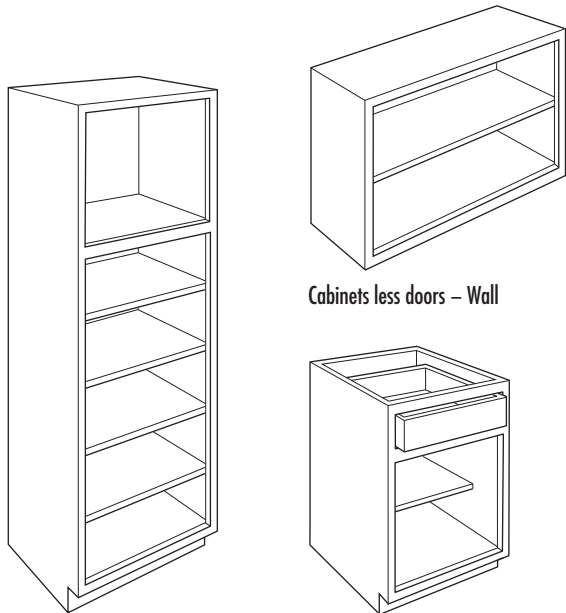

Cabinets less doors – Tall

Cabinets less doors – Wall

Cabinets less doors and drawer fronts – Base

CABINET CASE ONLY (CCO)

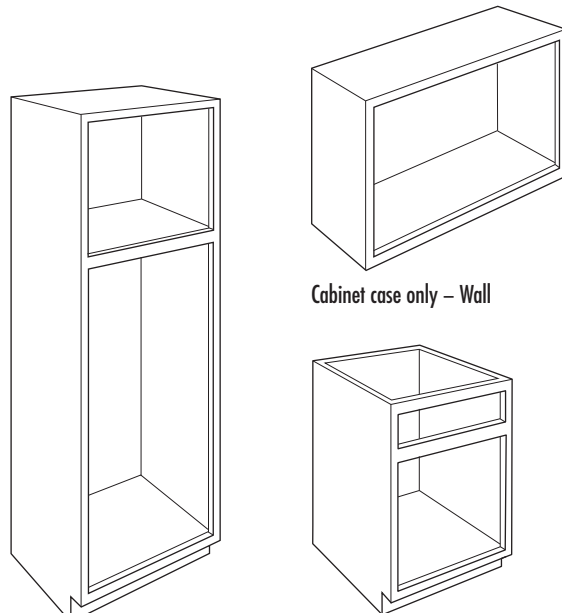

Cabinet case only – Tall

Cabinet case only – Wall

Cabinet case only – Base

CABINET FALSE PANEL (CFP)

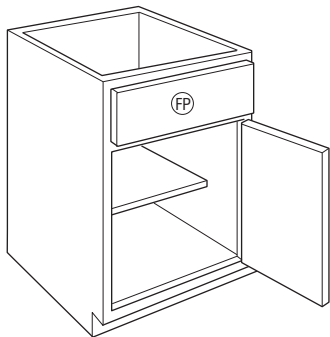

Base and Vanity cabinets

CABINET WITH NO DOOR, WITH DRAWER (CND)

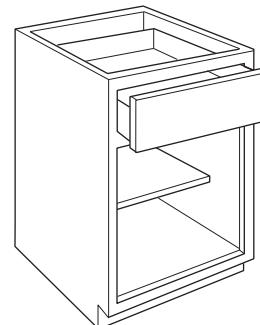

Base and Vanity cabinets

BOX MODIFICATIONS (cont'd)

See page 2 for modification compatibility.

OPTION NAME	APPLICABLE CABINET GROUP	DESCRIPTION/LIMITATIONS	PRICING
Increased Depth (ID)	Most wall, tall, and vanity cabinets	Increases the depth of wall and vanity cabinets in 3" increments to a maximum depth of 24". Drawer depth will not change. Increased depth wall cabinets should be either floor mounted or stacked to maintain stability. Any specified shelving is included and is always full depth. Wall Peninsula cabinets may be increased in 3" increments to 18" maximum.	Wall: \$284 list Tall: \$392 list Vanity: \$342 list
	End panels	Increases the depth in 3" increments to a maximum depth of 30".	List + 40%
	Box column fillers	Increases the depth in 3" increments to a maximum depth of 27".	List + 40%
Reduced Depth (RD)	Most base, tall, and vanity cabinets with drawers or roll trays	For Base and Vanity cabinets reduces the depth in 3" increments to a minimum of 12". For Tall cabinets reduces the depth in 3" increments to a minimum of 18". Any specified shelving is included and is always full depth. The dimension is specified as the distance from the front of the face frame to the back of the cabinet. Vanities will be reduced to 18" at no charge.	Wall: \$284 list Base: \$342 list Tall: \$392 list Vanity: \$342 list
	Most base, tall, and vanity cabinets without drawers or roll trays	Reduces the depth in 3" increments to a minimum depth of 12". Any specified shelving is included and is always full depth. The dimension is specified as the distance from the front of the face frame to the back of the cabinet. Vanities will be reduced to 18" at no charge.	
	Most wall cabinets	Reduces the depth in 3" increments to a minimum depth of 6". Any specified shelving is included and is always full depth. The dimension is specified as the distance from the front of the face frame to the back of the cabinet.	
	End panels, shelves, and box column fillers	Reduces the depth in 3" increments to a minimum depth of 6".	List + 30%
	Roll tray kits	Reduces the depth in 3" increments to fit a minimum cabinet depth of 12" for soft-close. Reduces the depth in 3" increments to fit a minimum cabinet depth of 18" for non soft-close.	

Cabinet Depth	Drawer Box and Roll Tray Exterior Depth			Clearance Behind Drawer Box or Roll Tray and Back Panel		
	Standard Guides	NSCFB Guides	Heavy Duty Side-mount Guides (DDFD)	Standard Guides	NSCFB Guides	Heavy Duty Side-mount Guides (DDFD)
24"	21"	21"	21"	2 3/4"	2 3/4"	2 3/4"
21"	18"	18", 15" for roll trays	18"	2 3/4"	2 3/4"	2 3/4"
18"	15"	15"	N/A	2 3/4"	2 3/4"	N/A
15"	12"	N/A	N/A	2 3/4"	N/A	N/A
12"	9"	N/A	N/A	2 3/4"	N/A	N/A

INCREASED DEPTH (ID)

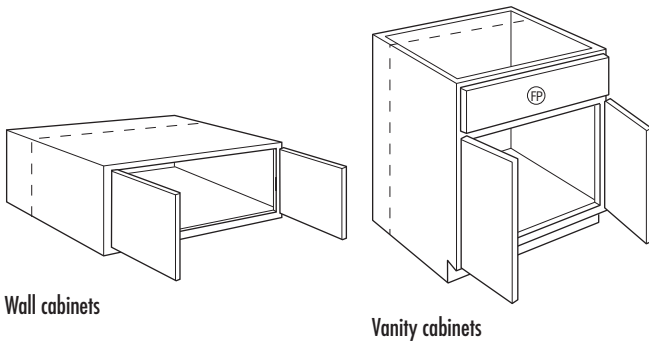

Wall cabinets

Vanity cabinets

REDUCED DEPTH (RD)

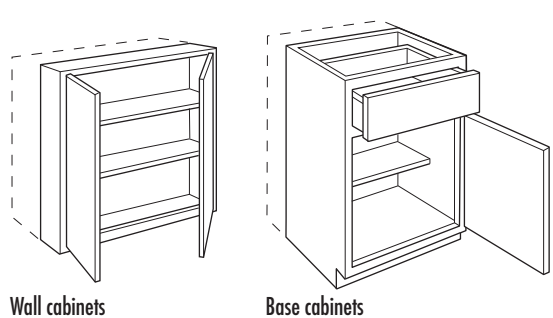

Wall cabinets

Base cabinets

INSTALLED INTERIOR MODIFICATIONS

See page 2 for modification compatibility.

OPTION NAME	APPLICABLE CABINET GROUP	DESCRIPTION/LIMITATIONS	PRICING
Full Depth Shelf (FD)	Base cabinets with standard half depth shelves	Replaces standard shelf with full depth shelf.	\$64 list per cabinet
Installed Roll Tray (RT)	Select base, tall, office, and vanity cabinets	<p>Installs specified number of roll trays (1-5). Example, for two roll trays, specify 2RT.</p> <p>When 1RT is specified on a base cabinet, the roll tray is installed in the lowest position and one half-depth adjustable shelf is included.</p> <p>On utility cabinets for the lower section, 1RT includes three shelves, 2RT includes two shelves, and 3RT includes 1 shelf. No shelves for lower section are included with 4RT or 5RT.</p> <p>See page 20 for RT positions.</p>	<p>1RT: Cabinet list + \$219</p> <p>2RT: Cabinet list + \$440</p> <p>3RT: Cabinet list + \$659</p> <p>4RT: Cabinet list + \$879</p> <p>5RT: Cabinet list + \$1,098</p>
Installed Roll Tray Both (RTB)	Select base and vanity cabinets with center stile	<p>On cabinets with center stile, installs a roll tray on both sides of the cabinet.</p> <p>1RTB - 2 roll trays</p> <p>2RTB - 4 roll trays</p> <p>3RTB - 6 roll trays</p> <p>4RTB - 8 roll trays</p> <p>See page 20 for RT positions.</p>	<p>1RTB: Cabinet list + \$438</p> <p>2RTB: Cabinet list + \$880</p> <p>3RTB: Cabinet list + \$1318</p> <p>4RTB: Cabinet list + \$1758</p>

FULL DEPTH SHELF (FD)

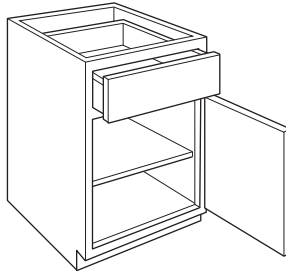

INSTALLED ROLL TRAY (RT)

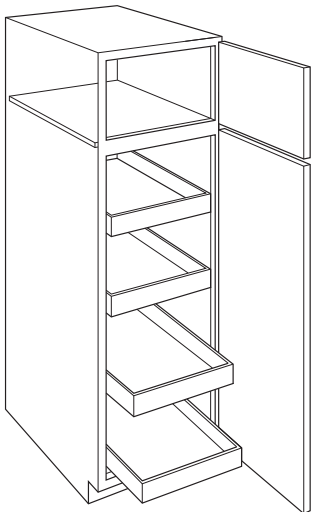

Tall cabinets

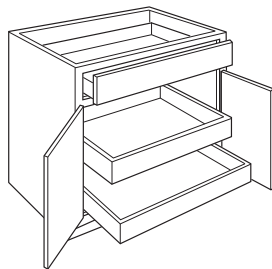

Base, Office, and Vanity cabinets

INSTALLED ROLL TRAY BOTH (RTB)

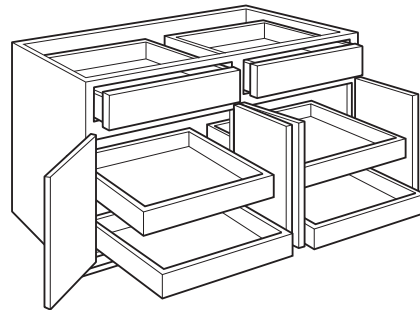

Base and Vanity cabinets with center stile

TOEKICK MODIFICATIONS

See page 2 for modification compatibility.

OPTION NAME	APPLICABLE CABINET GROUP	DESCRIPTION/LIMITATIONS	PRICING
Add Toekick (ADDTK)	Most wall cabinets	Creates a 4 1/2" toekick on the front of cabinet. ADDTK with reduced depth is available on cabinets 9" deep or larger. Peninsula cabinets are available with ADDTK 15" deep and larger. Available with compatible toekick modifications. See the Modification/Upgrade Compatibility Chart on page 2 for details.	\$140 list
Flush Toekick (FTK)	Most base, tall, vanity cabinets, and wall cabinets with ADDTK	Eliminates the recess at the toekick, creating 4 1/2" of space at the floor flush with the cabinet face frame; ideal for use with baseboard moulding. When FTK is ordered with the Peninsula modification, both sides will receive a flush toekick. Not available when either RECTKL or RECTKR modifications are used.	\$128 list

ADD TOEKICK (ADDTK)

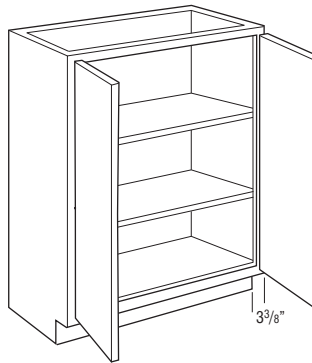

Wall cabinets

FLUSH TOEKICK (FTK)

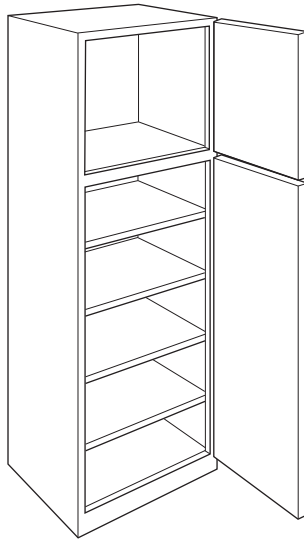

Tall cabinets

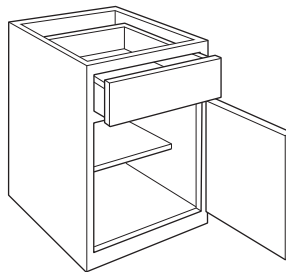

Base cabinets

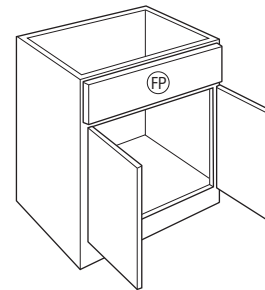

Vanity cabinets

TOEKICK MODIFICATIONS (cont'd)

See page 2 for modification compatibility.

OPTION NAME	APPLICABLE CABINET GROUP	DESCRIPTION/LIMITATIONS	PRICING
Flush Toekick Arch (FTKAV)	Most base, tall, and vanity cabinets, and wall cabinets with ADDTK	Creates an arch flush toe space. Valance replaces standard toekick creating a full open area beneath cabinet floor. When FTKAV is ordered with the Peninsula modification, both sides will receive an arch flush toekick. Not available on 9" or 12" wide cabinets.	\$160 list
Flush Toekick Furniture (FTKFV)	Most base, tall, and vanity cabinets, and wall cabinets with ADDTK	Creates a furniture flush toe space. Valance replaces standard toekick creating a full open area beneath cabinet floor. When FTKFV is ordered with the Peninsula modification, both sides will receive a furniture flush toekick. Not available on 9" or 12" wide cabinets.	\$160 list
Void Toekick (VTK)	Most base, tall, and vanity cabinets	Removes the toekick. Only available when the cabinet has a standard toekick (not available when flush toekick is standard or when cabinet has a separate pedestal base). When VTK is specified on cabinets to be used with a countertop, cabinets must also be supported from the floor, not just attached to the wall. Failure to properly install cabinets in this situation will void the warranty.	\$93 list

FLUSH TOEKICK ARCH (FTKAV)

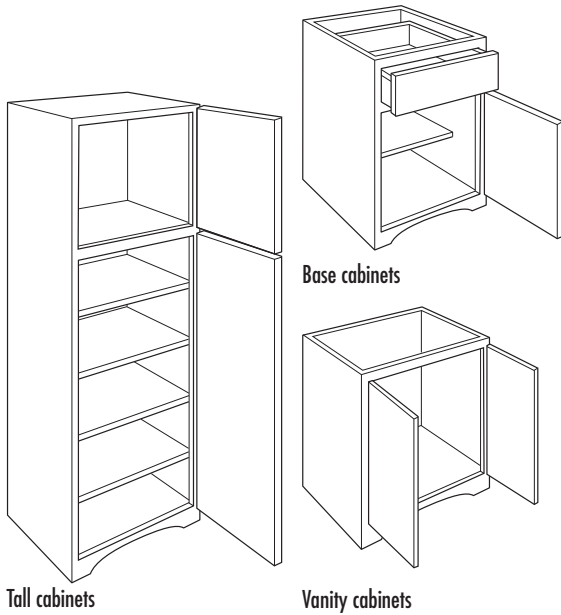

FLUSH TOEKICK FURNITURE (FTKFV)

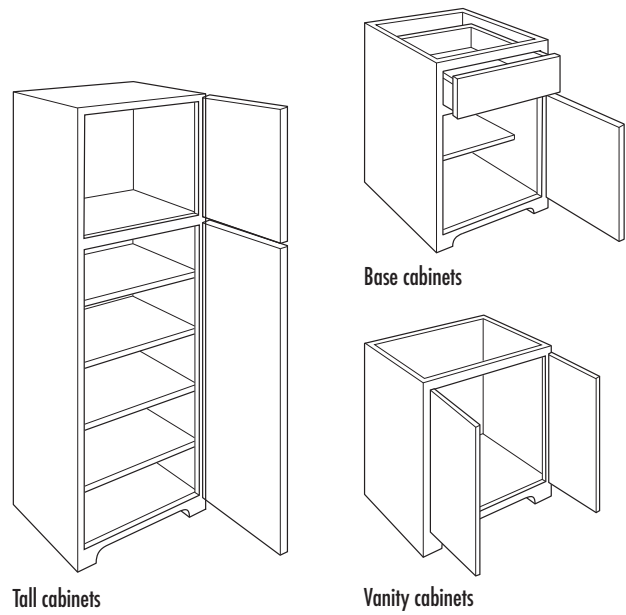

VOID TOEKICK (VTK)

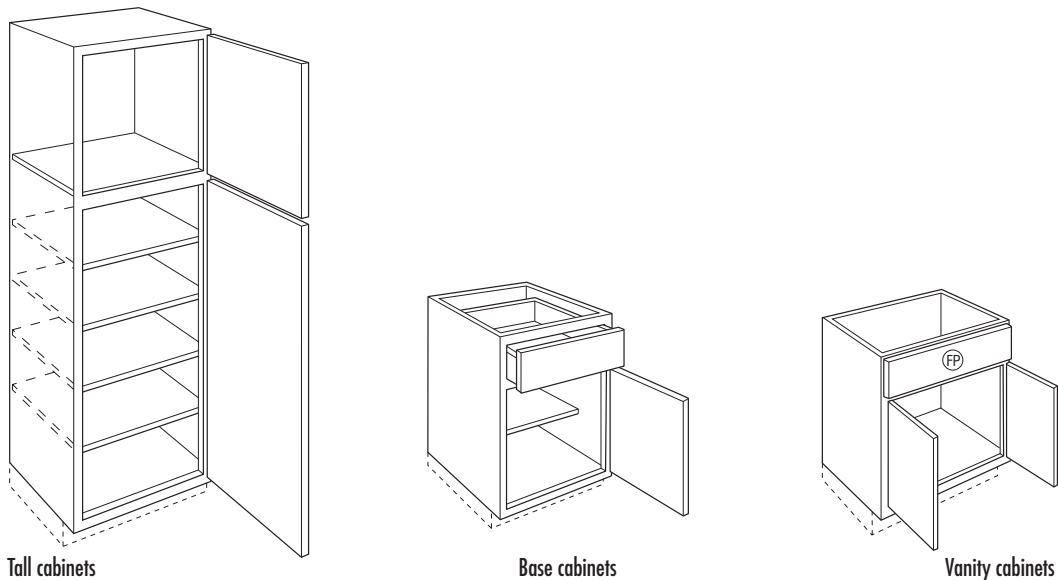

TOEKICK MODIFICATIONS (cont'd)

See page 2 for modification compatibility.

OPTION NAME	APPLICABLE CABINET GROUP	DESCRIPTION/LIMITATIONS	PRICING
Recessed Island Toekick (RECTKALL)	Base cabinets 27" - 48" wide and 24" deep	Creates a 3 3/8" recessed toekick on the right, left, and back of cabinet. The entire toekick area will have non-matching material and requires any exposed toekick area to be covered.	\$372 list
Recessed Toekick on Back or Side (RECTKBK) (RECTKL) (RECTKR)	Most base, tall, vanity cabinets, and wall cabinets with ADDTK	<p>Creates a 3 3/8" recessed toekick on the back (RECTKBK), left (RECTKL), or right (RECTKR). When either the RECTKR or RECTKL are used, FTK is NOT available. The entire toekick will have non-matching material and requires any exposed toekick area to be covered. On RECTKL and RECTKR, the back will have a 3/8" recessed offset and non-specified side will have a 1/2" recessed offset to allow for application of toeboard material.</p> <p>93" and 96" tall cabinets have RECTKL or RECTKR standard on loose pedestal. For recess toekick applications of both left and right, order RECTKL.R. On 9" wide cabinets, only one side can be recessed.</p> <p>RECTKBK only available on cabinets at least 15" deep.</p>	\$124 list per side

RECESSED ISLAND TOEKICK (RECTKALL)

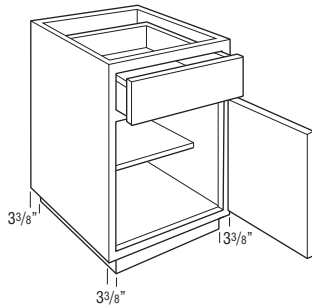

Base cabinets

CABINET BACK RECESSED TOEKICK (RECTKBK)

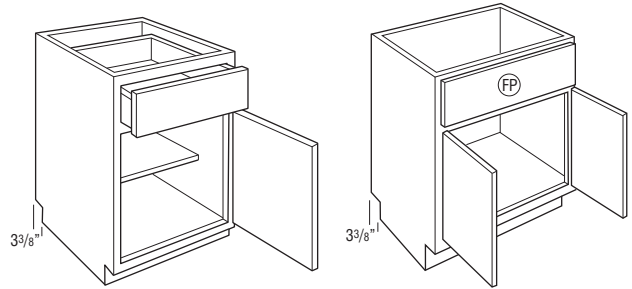

Base cabinets

Vanity cabinets

CABINET LEFT RECESSED TOEKICK (RECTKL)

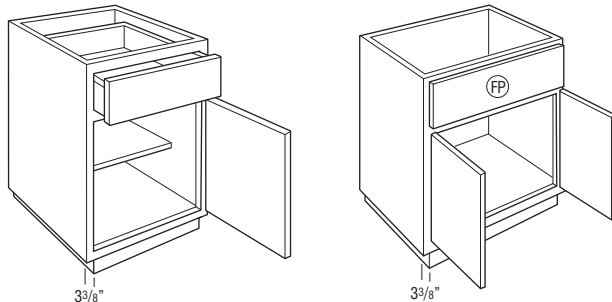

Base cabinets

Vanity cabinets

CABINET RIGHT RECESSED TOEKICK (RECTKR)

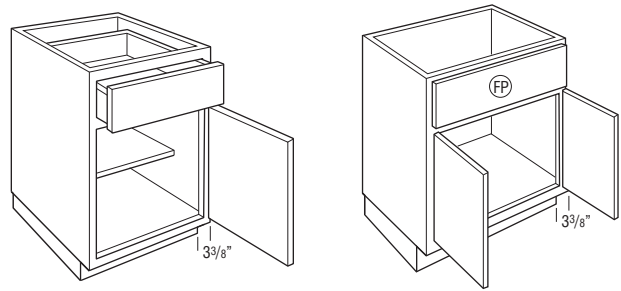

Base cabinets

Vanity cabinets

CONFIGURATION MODIFICATIONS

See page 2 for modification compatibility.

OPTION NAME	APPLICABLE CABINET GROUP	DESCRIPTION/LIMITATIONS	PRICING
Cabinet Front Only (CFNTO)	Most cabinets with a face frame	Creates a door and/or drawer front assembled with a frame. Doors are attached with the specified hinges and drawer fronts are cleated.	80% of cabinet list
Cabinet Frame Only (CFRMO)	Most cabinets with a face frame	Creates a cabinet frame only. No box, doors, or drawer fronts are included.	25% of cabinet list
Peninsula (P)	Most wall and base cabinets	Creates a peninsula cabinet that is 1/4" deeper than the standard cabinet depth. If ID or RD is specified, cabinet will be 1/4" deeper than specified cabinet depth. Not available on multi-drawer base cabinets. Any cabinet with a toekick must be at least 15" deep (either standard with a toekick or when ADDTK is specified). Any adjustable shelves are upgraded to full depth. A false drawer front and working doors will be placed on the back of a standard base cabinet modified to a peninsula base. Single door cabinets are hinged on the same cabinet end, for example a W1230L will feature a Left hinge on the front side and a Right hinge on the peninsula side. Wall peninsula cabinets are not designed to be used as stand alone island cabinets. The maximum depth for wall cabinets with the Peninsula modification is 18".	Cabinet list + 60%

CABINET FRONT ONLY (CFNTO)

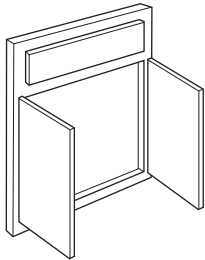

Cabinet front only – Wall, Base, and Tall

CABINET FRAME ONLY (CFRMO)

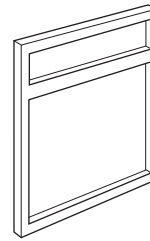

Cabinet frame only – Wall, Base, and Tall

PENINSULA (P)

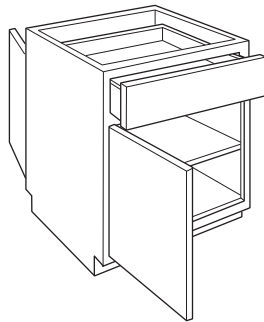

Base cabinets

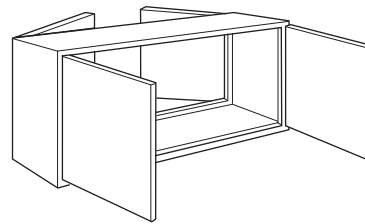

Wall cabinets

CUT-FOR-GLASS DOORS (CG)

Glass not included in price, but can be ordered separately. See below for details.

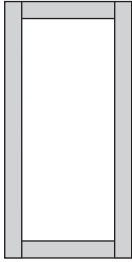

- Not available on bifold doors.
- CG.TOP and CG.BTM are specified on cabinets with upper and lower doors to designate which doors should be Cut-for-glass. See Door Options grid for SKU availability.
- Custom door sizes not available.
- Glass available for order separately (see pages 17-18).
- When a decorative door option is chosen in 20/20, Matching Interior Plywood (MIP) is a preselected option. If MIP is not desired, it can be deselected by choosing NOTMIP.
- All textured glass panels will be drop shipped separately from the cabinet order.
- Glass installation clips will ship with the doors and/or cabinets.
- The use of glass for base cabinet applications or for placement near interior or exterior doors is not recommended.

Cut-for-glass Door To Fit:	PRICE
	List per Door
30" High or Shorter Wall Cabinet	97
33" High Wall Cabinet	97
36" High Wall Cabinet	97
39" High Wall Cabinet	97
42" High Wall Cabinet	97

To price Cut-for-glass Doors attached to a cabinet, add the list price per door to the wall cabinet price (MIP modification upcharge will be applied to the cabinet price if matching interior is desired).

For a door only (not specified on a cabinet), add the list price for a door only to the Cut-for-glass door list price. See Doors and Drawer Fronts on page 157 for details.

STANDARD WALL CABINET AVAILABILITY*

Cabinet Width	Cabinet Height										
	12"	15"	18"	21"	24"	27"	30"	33"	36"	39"	42"
W9							✓	✓	✓	✓	✓
W12	✓	✓	✓	✓	✓	✓	✓	✓	✓	✓	✓
W15	✓	✓	✓	✓	✓	✓	✓	✓	✓	✓	✓
W18	✓	✓	✓	✓	✓	✓	✓	✓	✓	✓	✓
W21	✓	✓	✓	✓	✓	✓	✓	✓	✓	✓	✓
W24	✓	✓	✓	✓	✓	✓	✓	✓	✓	✓	✓
W24 (butt)	✓	✓	✓	✓	✓	✓	✓	✓	✓	✓	✓
W27 (butt)	✓	✓	✓	✓	✓	✓	✓	✓	✓	✓	✓
W30 (butt)	✓	✓	✓	✓	✓	✓	✓	✓	✓	✓	✓
W33 (butt)	✓	✓	✓	✓	✓	✓	✓	✓	✓	✓	✓
W36 (butt)	✓	✓	✓	✓	✓	✓	✓	✓	✓	✓	✓
W39 (CS)	✓	✓	✓	✓	✓	✓	✓	✓	✓	✓	✓
W42 (CS)		✓	✓	✓	✓	✓	✓	✓	✓	✓	✓
W45 (CS)			✓	✓	✓	✓	✓	✓	✓	✓	✓
W48 (CS)			✓	✓	✓	✓	✓	✓	✓	✓	✓
W42 (4 door)	✓	✓									
W45 (4 door)	✓	✓									
W48 (4 door)	✓	✓									
DW	✓	✓	✓		✓	✓	✓	✓	✓	✓	✓

*For Specialty Wall Cabinet and Oven Cabinet Availability, please see modification grid.

- For Cut-for-glass Door availability, please see modification grid in cabinet sections.

MULLION DOORS (MD)

Glass not included in price, but can be ordered separately. See below for details.

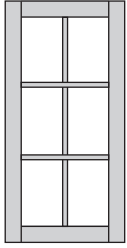

16

- Compatible glass styles are Clear, Frost, Reeded, and Seeded glass.
- MD.TOP and MD.BTM are specified on cabinets with upper and lower doors to designate which doors should be Mullion Doors. See Door Options grid for SKU availability.
- Custom door sizes not available.
- Shelves will not align with mullions.
- When a decorative door option is chosen in 20/20, Matching Interior Plywood (MIP) is a preselected option. If MIP is not desired, it can be deselected by choosing NOTMIP.
- All textured glass panels will be drop shipped separately from the cabinet order.
- Glass installation clips will ship with the doors and/or cabinets.
- The use of glass for base cabinet applications or for placement near interior or exterior doors is not recommended.

Mullion Door To Fit:	PRICE
	List per Door
15" High Wall Cabinet	391
18" High Wall Cabinet	391
24" High Wall Cabinet	391
30" High Wall Cabinet	391
33" High Wall Cabinet	423
36" High Wall Cabinet	423
39" High Wall Cabinet	423
42" High Wall Cabinet	423

To price Mullion Doors attached to a cabinet, add the list price per door to the wall cabinet price (MIP modification upcharge will be applied to the cabinet price if matching interior is desired).

For a door only (not specified on a cabinet), add the list price for a door only to the Mullion door list price. See Doors and Drawer Fronts on page 157 for details.

MULLION LITES GRID

Cabinet Width*	Cabinet Height							
	15"	18"	24"	30"	33"	36"	39"	42"
W15	G	G	G	D	D	D	A	A
W18	G	G	G	D	D	D	A	A
W21	G	G	G	D	D	D	A	A
W24	G	G	G	D	D	D	A	A
W24 (butt)	G	G	G	D	D	D	A	A
W27 (butt)	G	G	G	D	D	D	A	A
W30 (butt)	G	G	G	D	D	D	A	A
W33 (butt)	G	G	G	D	D	D	A	A
W36 (butt)	G	G	G	D	D	D	A	A
W42 (2 door)	G	G	G	D	D	D	A	A
W45 (2 door)		G	G	D	D	D	A	A
W48 (2 door)		G	G	D	D	D	A	A
W48 (4 door)	G							
DW	G	G	G	D	D	D	A	A

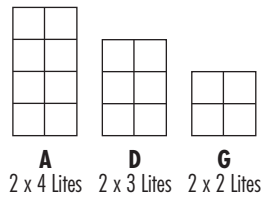

*Stacked wall cabinets (STW_ _) also available with MD option in selected widths.

- For Mullion Door availability, please see modification grid in cabinet sections.

TEXTURED GLASS PANELS



Bevel Clear Frost Reeded Seeded

- Cut-for-glass and mullion doors must be ordered separately. See pages 15-16.
- For glass shelf kits, see page 145.
- When textured glass is ordered for use in wall top hinge cabinets (WTH), glass design will be turned horizontally and may not match desired pattern.
- Door frame may reduce amount of glass shown.
- All textured glass panels will be drop shipped separately from the cabinet order.
- Glass installation clips will ship with the doors and/or cabinets.
- The use of glass for base cabinet applications or for placement near interior or exterior doors is not recommended.
- No changes or cancellations will be accepted after 24 hours from acknowledgment of order.

AVAILABILITY

Glass Cabinet Width	Cabinet Height										
	12"	15"	18"	21"	24"	27"	30"	33"	36"	39"	42"
W9							✓	✓	✓	✓	✓
W12	✓	✓	✓	✓	✓	✓	✓	✓	✓	✓	✓
W15	✓	✓	✓	✓	✓	✓	✓	✓	✓	✓	✓
W18	✓	✓	✓	✓	✓	✓	✓	✓	✓	✓	✓
W21	✓	✓	✓	✓	✓	✓	✓	✓	✓	✓	✓
W24	✓	✓	✓	✓	✓	✓	✓	✓	✓	✓	✓
W24 (butt)	✓	✓	✓	✓	✓	✓	✓	✓	✓	✓	✓
W27 (butt)	✓	✓	✓	✓	✓	✓	✓	✓	✓	✓	✓
W30 (butt)	✓	✓	✓	✓	✓	✓	✓	✓	✓	✓	✓
W33 (butt)	✓	✓	✓	✓	✓	✓	✓	✓	✓	✓	✓
W36 (butt)	✓	✓	✓	✓	✓	✓	✓	✓	✓	✓	✓
W39 (CS)	✓	✓	✓	✓	✓	✓	✓	✓	✓	✓	✓
W42 (CS)		✓	✓	✓	✓	✓	✓	✓	✓	✓	✓
W45 (CS)			✓	✓	✓	✓	✓	✓	✓	✓	✓
W48 (CS)			✓	✓	✓	✓	✓	✓	✓	✓	✓
W42 (4 door)	✓	✓									
W45 (4 door)	✓	✓									
W48 (4 door)	✓	✓									
DW	✓	✓	✓		✓	✓	✓	✓	✓	✓	✓

TEXTURED GLASS PANELS PRICING

TEXTURED GLASS PANELS

STYLE	PANEL THICKNESS	HEIGHT		
		12" – 18" TALL	21" – 30" TALL	33" – 42" TALL
Bevel	1/4"	220	245	269
Clear	1/8"	186	206	226
Frost	5/32"	220	245	269
Reeded	5/32"	186	206	226
Seeded	1/8"	346	385	423

TEXTURED GLASS PANELS

Bevel

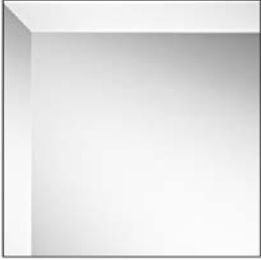

- Glass type: Clear
- Panel thickness: 1/4"
- Not available with Mullion Doors.

Reeded

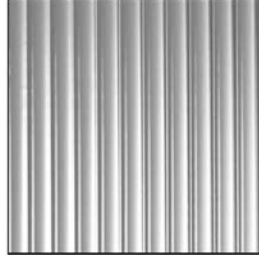

- Glass type: Reeded
- Panel thickness: 5/32"

Clear

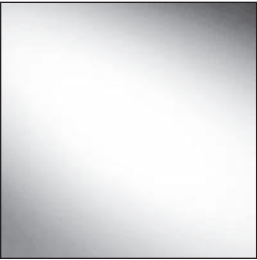

- Glass type: Clear
- Panel thickness: 1/8"

Seeded

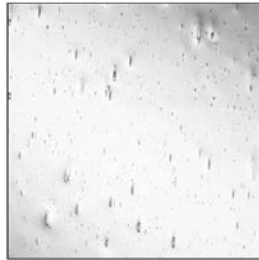

- Glass type: Seeded
- Panel thickness: 1/8"

Frost



- Glass type: Frost
- Panel thickness: 5/32"

CABINET DIMENSIONS

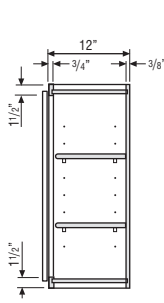

WALL CABINET

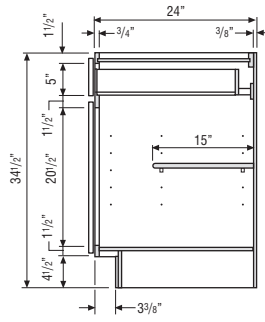

BASE CABINET

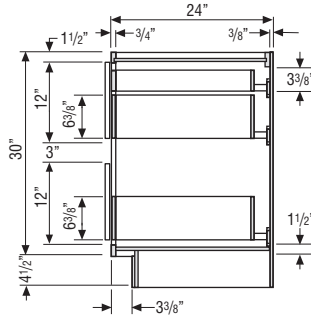

**TWO-DRAWER
BASE CABINET
with ROLL TRAY**

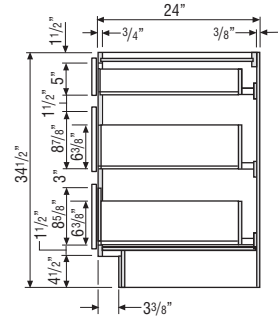

**THREE-DRAWER
BASE CABINET**

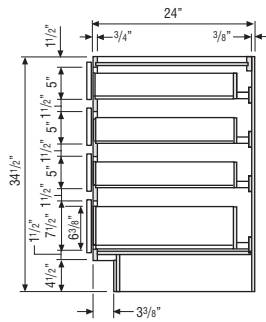

**FOUR-DRAWER
BASE CABINET**

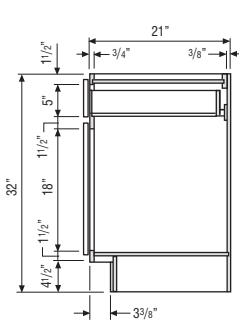

**32" HIGH
VANITY CABINET**

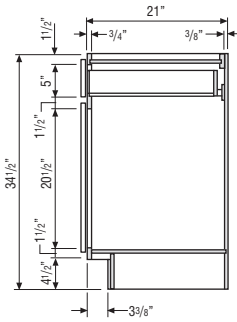

**34 1/2" HIGH
VANITY CABINET**

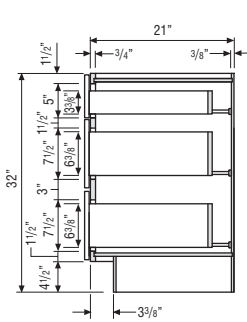

**32" HIGH
VANITY DRAWER
BASE CABINET**

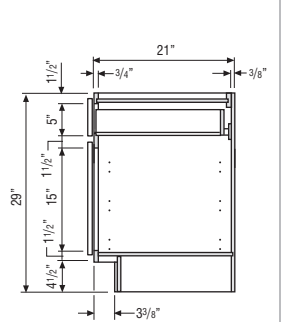

DESK BASE CABINET

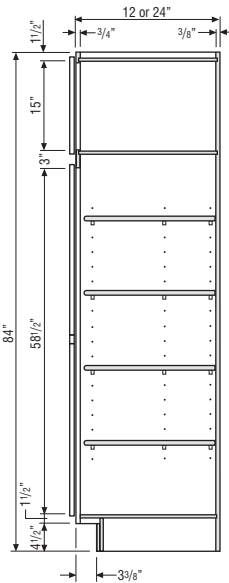

UTILITY CABINET

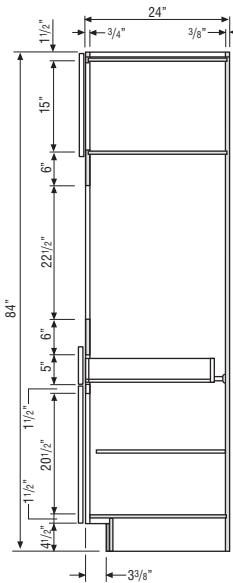

SINGLE OVEN CABINET

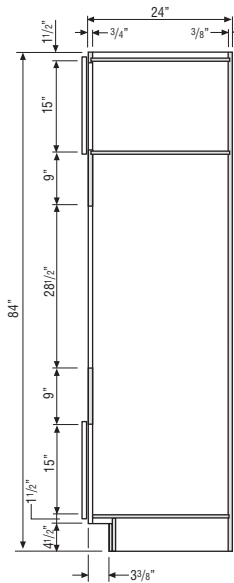

**OVEN MICROWAVE
COMBO CABINET**

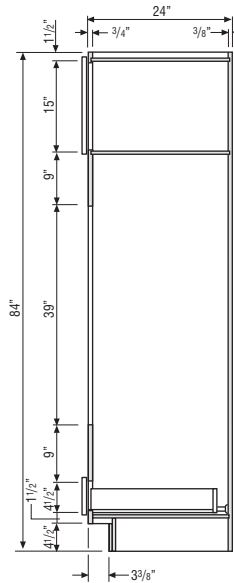

DOUBLE OVEN CABINET

CABINET DIMENSIONS

ROLL TRAY POSITIONS

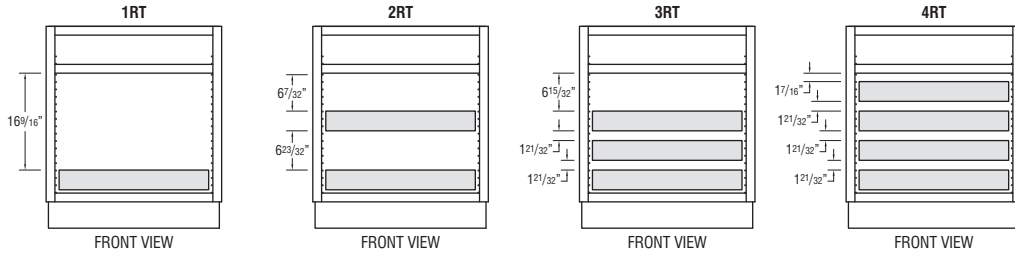

BASE CABINETS AND 34 1/2" HIGH VANITY CABINETS

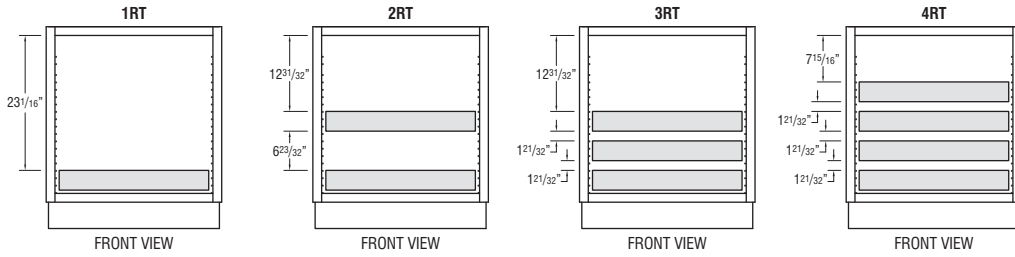

FULL HEIGHT BASE CABINETS

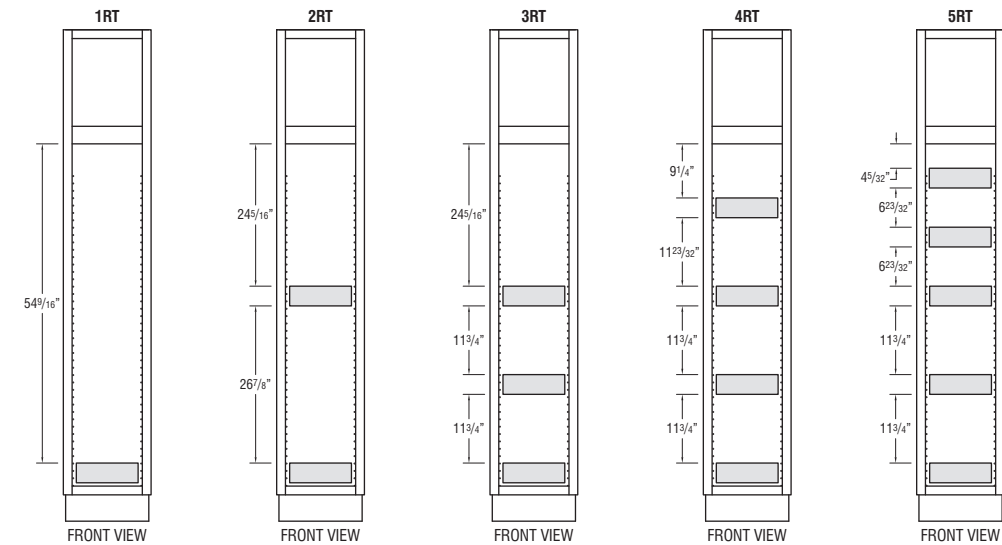

UTILITY CABINETS

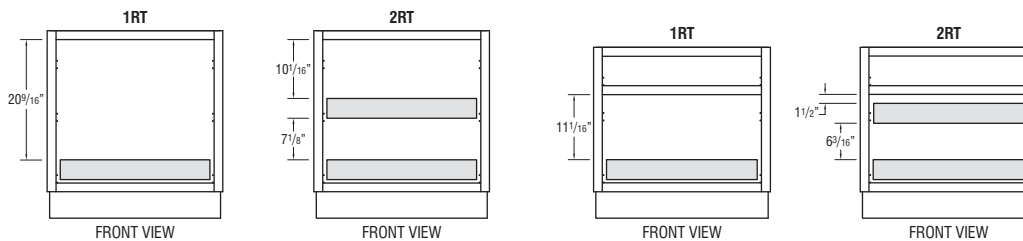

32" HIGH VANITY CABINETS

DESK DOOR DRAWER BASE CABINETS

CABINET DIMENSIONS

- 1 1/2" Top and Bottom Rails - Wall and Base Cabinets.
- 1 1/2" Vertical Stiles.
- 3" Center Vertical Rails on Wall and Base Cabinets to Divide Double Door Cabinets 39" Wide and Over.

DOOR AND DRAWER FRONT SIZES	FULL OVERLAY	PARTIAL OVERLAY
Face Frame Reveal (see Overlay Specifications page for more details)	1/4" Reveal Around Doors	1" Reveal Around Doors
Door Size for Base/Wall Cabinets	Frame Opening + 2 1/2"	Frame Opening + 1"
4 1/2" or 5" High Drawer Opening	6 1/4" Drawer Front	5 1/2" Drawer Front
7 1/2" High Drawer Opening	10" Drawer Front	8 1/2" Drawer Front
8 5/8" High Drawer Opening	11 3/8" Drawer Front	9 7/8" Drawer Front
8 7/8" High Drawer Opening	11 3/8" Drawer Front	10 5/8" Drawer Front
12" High Drawer Opening	14 1/2" Drawer Front	13" Drawer Front
14" High Drawer Opening	16 1/2" Drawer Front	15" Drawer Front

84" HIGH APPLICATION

Number after Wall Cabinet Represents Height of Cabinet

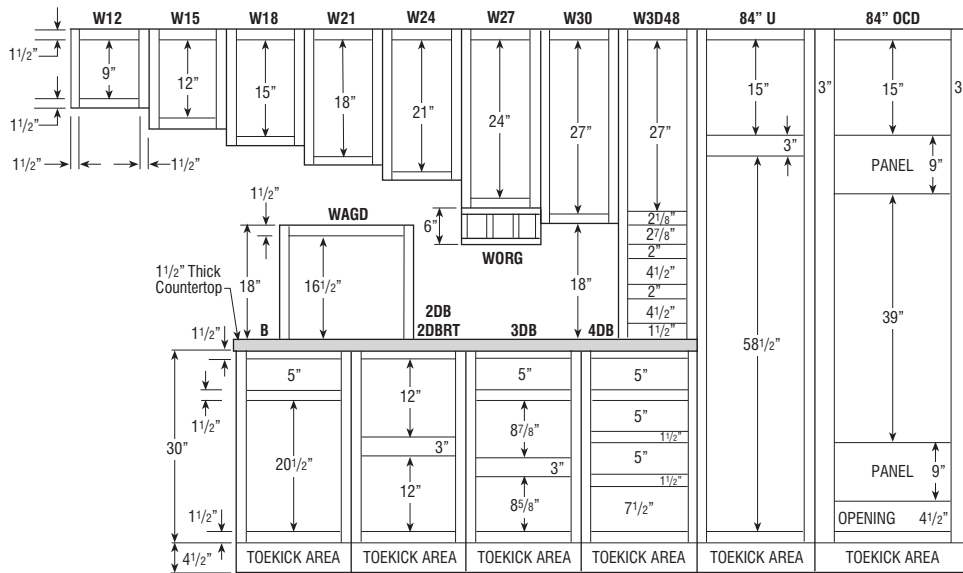

CABINET DIMENSIONS

87" HIGH APPLICATION

Number after Wall Cabinet Represents Height of Cabinet

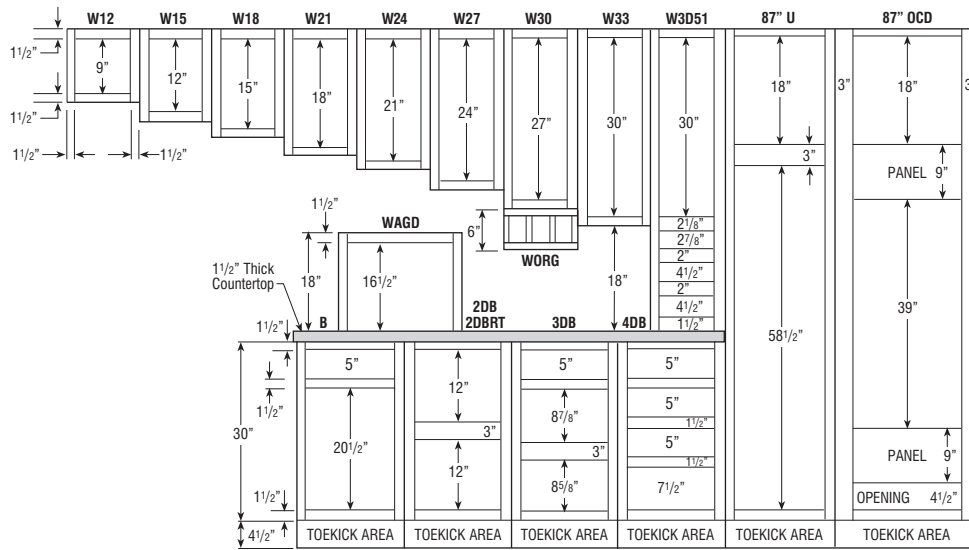

90" HIGH APPLICATION

Number after Wall Cabinet Represents Height of Cabinet

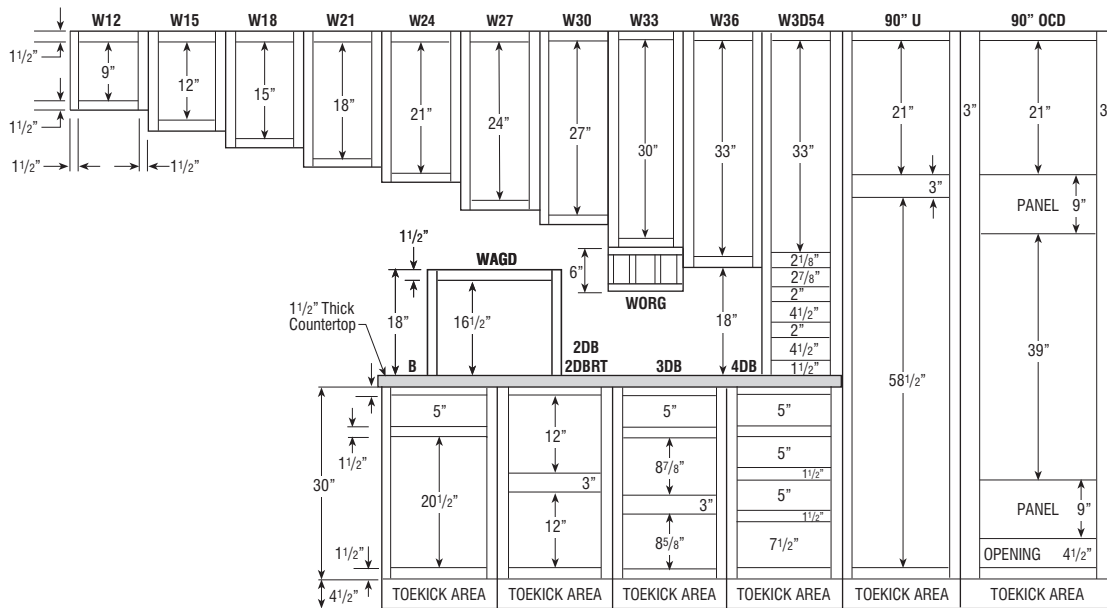

CABINET DIMENSIONS

93" HIGH APPLICATION

Number after Wall Cabinet Represents Height of Cabinet

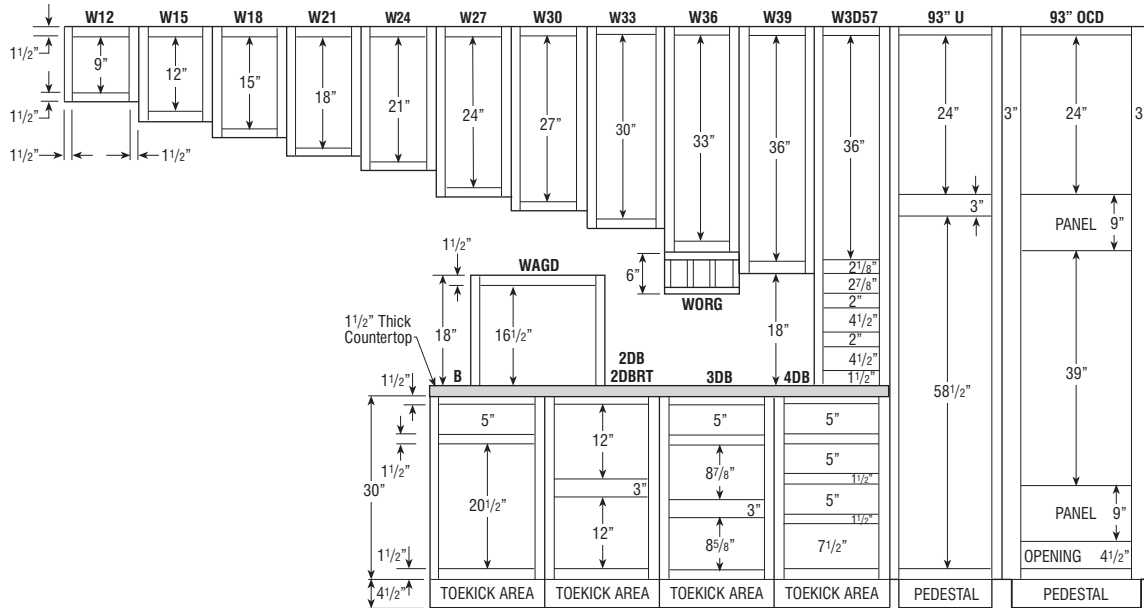

96" HIGH APPLICATION

Number after Wall Cabinet Represents Height of Cabinet

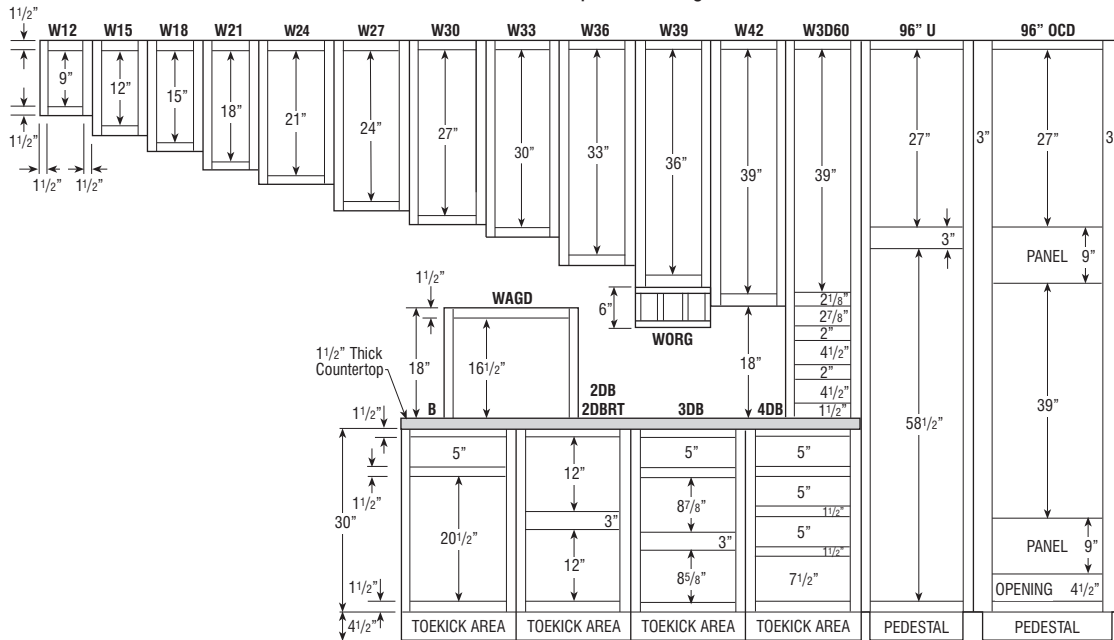

CABINET DIMENSIONS

32 1/2" HIGH UNIVERSAL ACCESS CABINETS, 24" DEEP

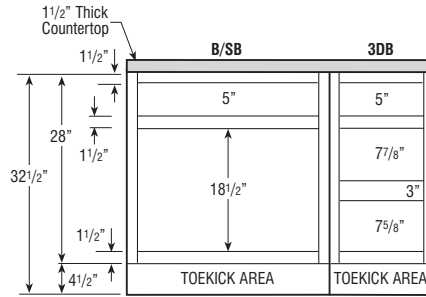

32" HIGH UNIVERSAL ACCESS CABINETS, 21" DEEP

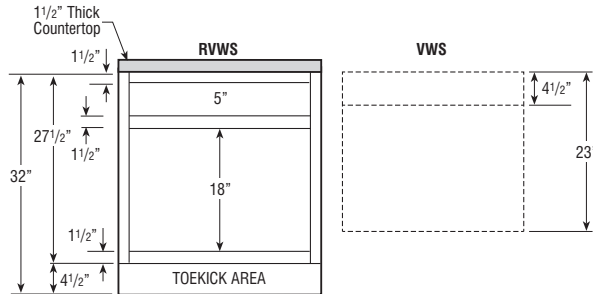

RVWS must be ordered with Vanity Wall Sink (VWS.23) not designed to be a stand-alone unit. See page 88 for more details.

CABINET DIMENSIONS

29" HIGH DESK CABINETS

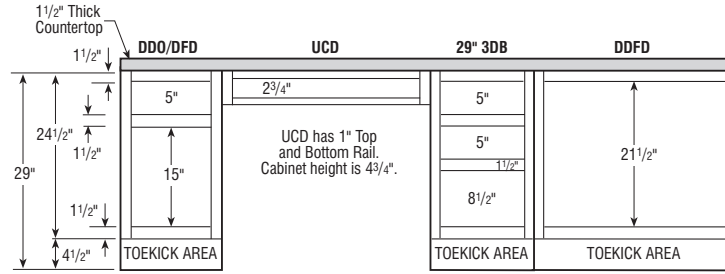

32" HIGH VANITY CABINETS

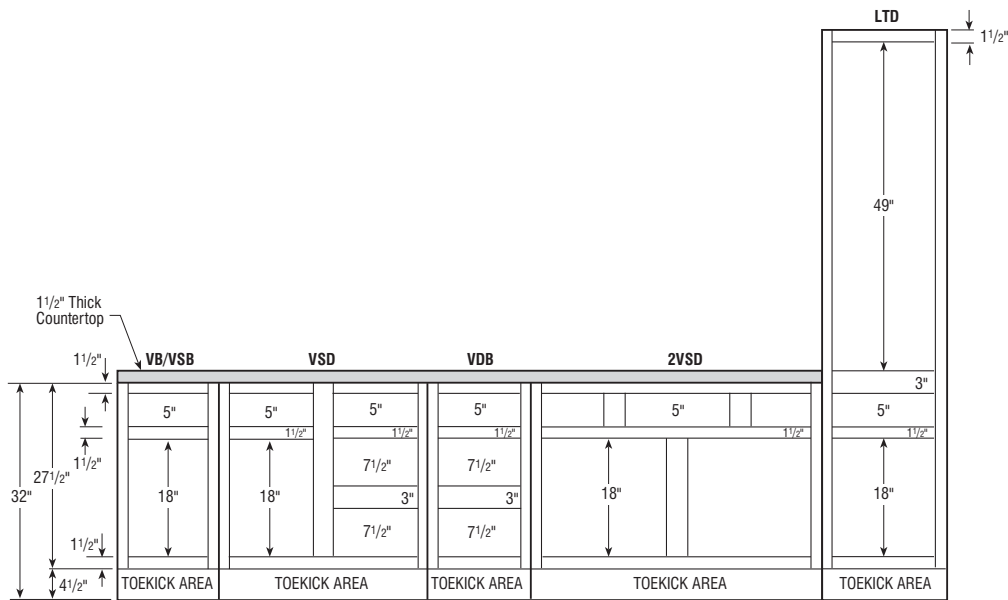

34 1/2" HIGH VANITY CABINETS

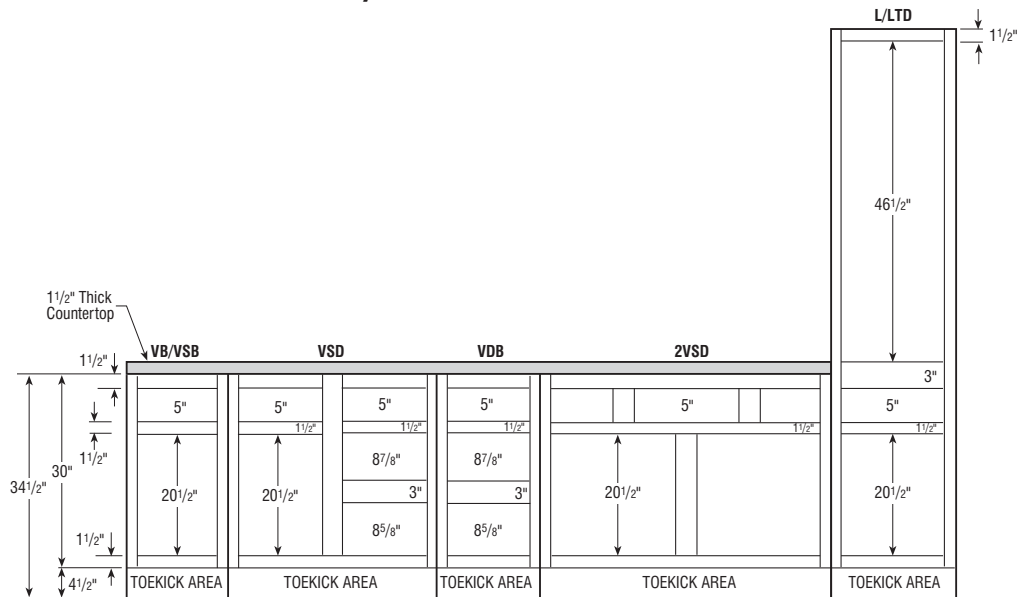

CABINET DIMENSIONS

DIMENSIONS FOR CORNER INSTALLATIONS (45° DIAGONAL)

12" DEEP CABINETS

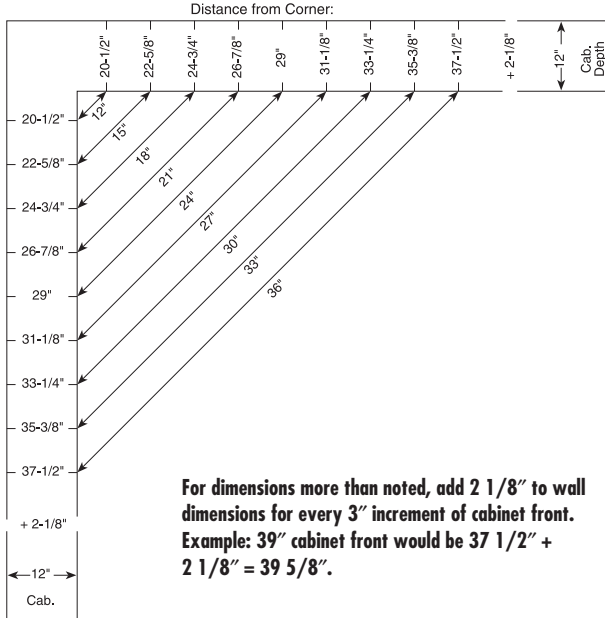

24" DEEP CABINETS

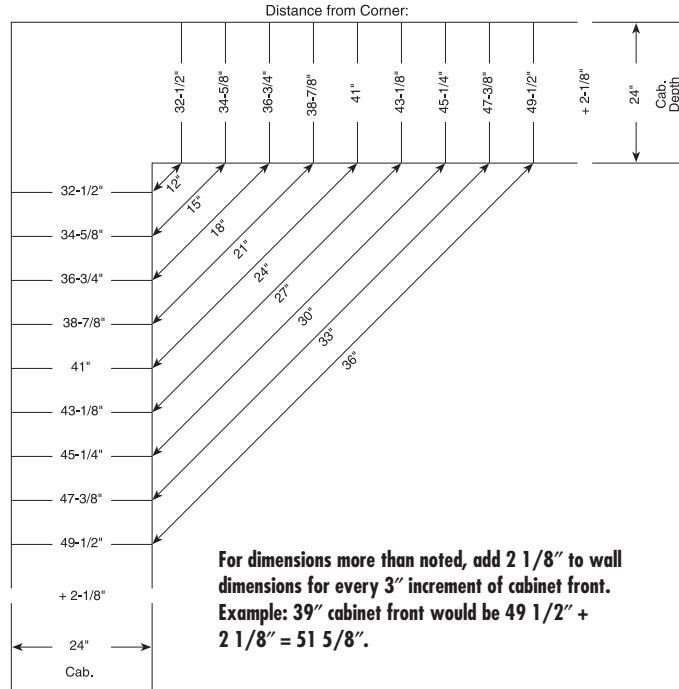

INSTALLATION HEIGHT REQUIREMENTS

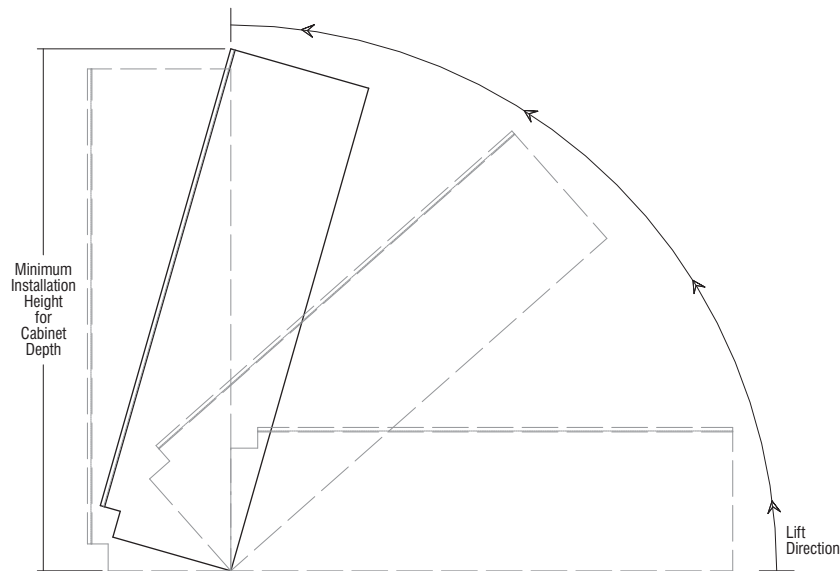

Height of ceiling needs to be considered for installation of tall cabinets. Cabinet height below includes toekick area:

Cabinet Height	Minimum Installation Height for Cabinet Depth				
	12"	15"	18"	21"	24"
84"	84 7/8"	85 11/32"	85 15/16"	86 19/32"	87 3/8"
87"	87 27/32"	88 5/16"	88 27/32"	89 1/2"	90 1/4"
90"	90 13/16"	91 1/4"	91 13/16"	92 7/16"	93 5/32"
93"*	89 5/16"	89 25/32"	90 5/16"	90 31/32"	91 23/32"
96"*	92 5/16"	92 3/4"	93 9/32"	93 29/32"	94 5/8"

*Separate pedestal base included with cabinet to be installed after cabinet is in an upright position.

DESIGN CHECKLIST

CONSTRUCTION OPTIONS

Consider exposed end options:

- Modify exposed cabinet ends to FPEB.
- Apply 1/4" skin to hide 1/4" reveal. This will allow the ends to age uniformly with the rest of the kitchen and will make it flush.
- Apply decorative door kit (BEDSD, WED, TED). This kit includes 1/4" skin, decorative doors, and screws for field installation.

WOOD AND FINISH CHARACTERISTICS

Review specific details with the customer:

- Mineral Streaks, Birdseye Dots, Grain Variations.
- Color Variations/Darkening.
- Finish Variations (Glazes are "consistently inconsistent"), hairline cracks may develop at frame joints on painted frame.
- Underside of cabinets are natural maple laminate. Use light rail or cabinet panel edge and skin to hide, especially when designing with peninsula wall cabinets.

INNOVATIVE OPTIONS

Review storage and usage needs with Customer. See page 30 for complete chart.

- Cooking Solutions:
 - Wall Spice Rack Cabinet
- Storage Solutions:
 - SuperCabinet™
 - Pegged Dish Organizer
 - Wall Message Center
- Clean-up Center:
 - Base Wastebasket

CLEARANCES

- Add fillers between end cabinets and walls on full overlay door styles.
- Allow space between door/window trim and end cabinets for countertop and top moulding overhang.
- Include refrigerator door hinges in overall refrigerator height when placing cabinets above it.

Maintain a minimum clearance of 3" by pulling blind corners as follows:

- Full Overlay: 1 1/4", Standard Overlay 1/2". (More is needed in certain situations such as when adjacent to an appliance or when using oversized pulls or knobs.)
- Allow sufficient clearance (3") on each side of accessory cabinets (such as roll-out trays, etc). Doors on these cabinets must open fully for accessories to be functional.
- Ensure the height between the cooktop and range hood is 24" to meet NKBA guidelines.

Qualify customer carefully on upper cabinet/microwave advantages/disadvantages as follows:

- Minimum of 18" from cooktop to upper cabinet/above the range microwave which allows for easy access to either, but less room over back burner.
- Minimum of 21" from cooktop to upper cabinet/microwave which allows for access to large pots on back burner of cooktop, but longer reach to microwave.

FILLERS

- Place fillers toward end of run where least conspicuous if needed.
- Attach overlay fillers on top of the base, wall, or tall fillers when using full overlay door styles to maintain a consistent reveal. Don't forget to include blind corner fillers.
- Add a filler at least 6" wide to accommodate a decorative onlay when the filler is used as valance.

VARYING HEIGHTS AND DEPTHS

- Also increase the depth of a wall cabinet run when you increase the height (so moulding on adjacent cabinet will kill into the side of the taller cabinet).
- Skin the sides of tall cabinets to 1) hide the seam between the toekick pedestal and the cabinet, 2) keep adjacent base and wall cabinets out from reveal of tall cabinet.
- Add increased depth on tall end panels for a built-in look for deep refrigerators.
- Account for the additional support needed for wall cabinets with a depth of 18" or greater. This can be achieved by installing a soffit or end panels.

MATCHING INTERIOR CABINETS/GLASS OPTIONS

- Verify cut-for-glass or mullion door option is available on desired cabinet size. (See pages 15-16 for available cut-for-glass/mullion door sizes.)
- Verify glass insert option is available for desired cut-for-glass door size chosen.
- Verify matching interior option has been selected for all open or glass cabinets.
- Use light rail and skin to hide color variation between bottom of cabinets with and without matching interior.
- Verify mullion door lite grid matches customer expectations.

MOULDINGS

- Verify correct amount of crown moulding has been ordered.
- Order toekick caps.
- Order extra scribe.

ISLANDS AND PENINSULAS

- Consider standard height bars are 34 1/2" tall and require 19" knee space. Raised bars are 42" tall.
- Consider base peninsula cabinets (P) are 24 1/4" deep and require 12" of knee space. Use back panels/doors to flush non-P cabinets with P cabinets.
- Use outside corner moulding if a skin is exposed on the back of the island.

APPLIANCES

- Note for all consumers, appliances are not included with any cabinetry product.
- Do not place dishwashers next to diagonal front cabinet (interference) or next to a range (no countertop support).
- Verify refrigerator door has enough clearance to open beyond 90 degrees so refrigerator drawers can be utilized. Refer to appliance manufacturer's specs.
- Add TF696FH, as it may be required to frame around built-in microwave ovens and other built-in items. Refer to appliance manufacturer's specs.
- Order appliance panels.

SPECIAL CONSIDERATIONS

- Consider V-groove skins and/or decorative doors on exposed cabinet sides in glazed kitchen.

MISCELLANEOUS

- Order full size touch-up kit (mini touch-up kit included with standard sink base).

kitchen planning guidelines

DOOR/ENTRY

- Door opening should be at least 32" wide, requiring a minimum 2' 10" wide door.

DOOR INTERFERENCE

- Entry door should not interfere with safe appliance operation or appliance doors.

DISTANCE BETWEEN WORK CENTERS

- With three work centers, the total distance traveled should not be more than 26' with no single leg of the triangle less than 4' or more than 9'.
- With more than three work centers, each additional travel distance to another work center should be no less than 4' or more than 9'. Each leg is measured from the center-front of the appliance/sink. No work triangle leg should intersect an island/peninsula by more than 12".

SEPARATING WORK CENTERS

- A tall obstacle should not separate two primary work centers. A properly recessed tall corner unit is acceptable.

WORK TRIANGLE TRAFFIC

- Major traffic patterns should not cross through the basic work triangle.

WORK AISLE

- The work aisle should be at least 42" for one cook and at least 48" for multiple cooks.

WALKWAY

- The walkway width should be at least 36".

TRAFFIC CLEARANCE AT SEATING

- Allow 32" of clearance from the table to wall/obstacle if no traffic passes behind a seated diner. If traffic passes behind the diner, allow at least 36" to edge past or 44" to walk past.

SEATING CLEARANCE

- 30" high tables/counters should allow a 24" wide by 18" deep space for each seated diner and at least 18" knee space.
- 36" high counters should allow a 24" wide by 15" deep space for each seated diner and at least 15" kneespace.
- 42" high counters should allow a 24" wide by 12" deep space for each seated diner and at least 12" kneespace.

CLEAN-UP/PREP SINK PLACEMENT

- With only one sink, locate it adjacent to or across from the cooking surface and refrigerator.

CLEAN-UP/PREP SINK LANDING AREA

- Include at least a 24" wide landing space on one side of the sink and 18" on the other.
- If all the countertop at the sink is not the same height, plan a 24" landing space on one side of the sink and 3" of countertop frontage on the other, both at the same height of the sink.

PREPARATION/WORK AREA

- Include a section of countertop at least 36" wide x 24" deep next to the sink for a work area.

DISHWASHER PLACEMENT

- Nearest edge of dishwasher should be within 36" of nearest edge of sink. Provide at least 21" of standing space between the edge of the dishwasher and countertop frontage/appliances/cabinets which are placed at a right angle to the dishwasher.

WASTE RECEPTACLES

- Include at least 2 waste receptacles, one near the sink and the other nearby for recycling.

AUXILIARY SINK

- Provide at least 3" of countertop frontage on one side of the auxiliary sink and 18" on the other side, both at the same height as the sink.

REFRIGERATOR LANDING AREA

- Include at least 15" of landing area on the handle side of the refrigerator, 15" on either side of a side-by-side refrigerator, 15" of landing space which is no more than 48" across from the front of the refrigerator, and 15" above or adjacent to any under-counter style refrigerator.

COOKING SURFACE LANDING AREA

- Include a minimum of 12" of landing area on one side of the cooking surface and 15" on the other.
- If cooking surface is at a different countertop height than the rest of the kitchen, then the 12" and 15" landing areas must be the same height as the cooking surface.
- For safety reasons, in an island or peninsula situation, the countertop should extend a minimum of 9" behind the cooking surface if the counter height is the same height as the cooking surface.

COOKING SURFACE CLEARANCE

- Allow 24" between the cooking surface and a protected noncombustible surface above it.
- At least 30" of clearance is required between the cooking surface and an unprotected/combustible surface above it.
- If a microwave/hood combination is used, then the manufacturer's specifications should be followed.

COOKING SURFACE VENTILATION

- A correctly sized, ducted ventilation system is recommended for all cooking surface appliances. The recommended minimum is 150 CFM.
- Code requires that the manufacturer's specifications be followed. Minimum exhaust rate for a ducted hood is 100 CFM and must be ducted to the outside.
- Make-up air may need to be provided. Refer to local codes.

COOKING SURFACE SAFETY

- Do not locate cooking surface under an operable window.
- Window treatments above cooking surface should not use flammable materials.
- Place a fire extinguisher near the kitchen exit away from cooking equipment.

MICROWAVE OVEN PLACEMENT

- The ideal location for the bottom of the microwave is 3" below the principle user's shoulder, but no more than 54" above the floor.

MICROWAVE LANDING AREA

- Provide at least 15" above, below, or adjacent to the handle side of a microwave oven.

OVEN LANDING AREA

- Include at least 15" next to or above the oven.
- A 15" landing area that is not more than 48" away is also acceptable as long as the oven does not open into a walkway.

COMBINING LANDING AREAS

- If two landing areas are adjacent to one another, determine a new minimum for the two by taking the longer of the two and adding 12".

continued

kitchen planning guidelines (continued)

COUNTERTOP SPACE

- A total of 158" of countertop frontage, 24" deep, with at least 15" clearance above is needed to accommodate all landing, preparation, work, and storage areas.

COUNTERTOP EDGES

- Clipped or round corners, rather than sharp edges, are recommended on all counters.

STORAGE

- The recommended total shelf/drawer frontage for a small kitchen (less than 150 square feet) is 1400", for a medium kitchen (151 to 350 square feet) is 1700", and for a large kitchen (greater than 350 square feet) is 2000".

Sizes:	S	M	L
Wall	300"	360"	360"
Base	520"	615"	660"
Drawer	360"	400"	525"
Pantry	180"	230"	310"
Misc.	40"	95"	145"

- The totals for wall, base, drawer, and pantry shelf/drawer frontage can be adjusted upward or downward as long as the recommended total stays the same.

STORAGE AT CLEAN-UP/PREP SINK

- The recommended total for a small kitchen is 400", a medium kitchen is 480", a large kitchen is 560", and should be located within 72" of the centerline of the main clean-up/prep sink.

CORNER CABINET STORAGE

- At least one corner cabinet should include a functional storage device.

ELECTRICAL RECEPTACLES

- GFCI (Ground-Fault-Circuit-Interrupter) protection is required on all receptacles servicing countertop surfaces within the kitchen.

LIGHTING

- Every work surface should be well illuminated. At least one wall switch-controlled light must be placed at the entrance.
- Window/skylight area, equal to at least 8% of the total square footage of the kitchen, or a total living space which includes a kitchen, is required.

bathroom planning guidelines

DOOR/ENTRY

- Doorway opening should be at least 32", requiring a minimum 2' 10" wide door.

DOOR INTERFERENCE

- The door area should include clear floor space for maneuvering which varies according to the type of door and the direction of the approach.

CEILING HEIGHT

- Bathroom floor to ceiling minimum height is 80". A shower or tub with a shower head shall have a minimum floor to ceiling height of 80" above a minimum area 30" x 30" at the shower head.

CLEAR SPACE

- Plan a clear space of 30" from the front edge of all fixtures to any opposite bath fixture, wall, or obstacle.
- A minimum space of at least 21" is required in front of a lavatory, toilet, bidet, and tub, with a 24" minimum space in front of a shower entry.

SINGLE LAVATORY PLACEMENT

- The distance from the centerline of the lavatory to the sidewall/tall obstacle should be at least 20".
- The minimum distance required is 15". The minimum distance required between a wall and the edge of a lavatory is 4".

DOUBLE LAVATORY PLACEMENT

- The distance between the centerlines of two lavatories should be at least 36".
- The minimum distance required is 30".
- The minimum distance required between the edges of two lavatories is 4".

LAVATORY/VANITY HEIGHT

- The height for a lavatory varies from 32" to 43" to fit the user.

COUNTERTOP EDGES

- Clipped or round corners, rather than sharp edges, are recommended on all counters.

SHOWER SIZE

- The interior shower size should be at least 36" x 36". The minimum interior shower size required is 30" x 30".

STORAGE

- Provide adequate, accessible storage for toiletries, bath linens, grooming and general bathroom supplies.
- Storage of frequently used items should be 15" to 48" above floor.

ELECTRICAL RECEPTACLES

- All GFCI receptacles should be located at electrical appliance points of use.

Load bearing floors and shelves can support 15 lbs. per square foot. Warranty does not cover overloading beyond this point.

To view a complete and updated list of the NKBA Guidelines, visit <https://nkba.org/info/guidelines>

© Copyright 2007 National Kitchen & Bath Association

INNOVATIVE OPTIONS REFERENCE CHART

Wall Cabinets		Description	3"	6"	9"	12"	15"	18"	21"	24"	27"	30"	33"	36"	39"	42"	45"	48"	Page
WBCPO____, WBCPO____OL		Wall Box Column Pull-outs	•	•															54
WMC12__ L or R		Wall Message Center	•																56
WSC_____		Wine Storage Cabinet				•	•	•	•	•									55
WSP_____		Wall Spice Pull-outs			•	•													54
Base Cabinets		Description	3"	6"	9"	12"	15"	18"	21"	24"	27"	30"	33"	36"	39"	42"	45"	48"	Page
2DB__RT		Two Drawer Bases w/Roll Tray								•		•		•					79
3DB__WTCD		Three Drawer Bases w/Wood Tiered Cutlery Divider Drawer					•	•	•	•									79
4DB__WTCD		Four Drawer Bases w/Wood Tiered Cutlery Divider Drawer					•	•	•	•									80
B__FHMIXSC L or R		Base Cabinet with Mixer Shelf						•	•	•									68
B__TDRO L or R		Bases w/Roll-out Tray Divider				•	•												67
BBCPO____, BBCPO__OL		Base Box Column Pull-outs	•	•															82
BPP__		Base Pantry Pull-outs			•	•													81
BSC_____		SuperCabinet™										•		•					66
BUPP__		Base Utensil Pantry Pull-out			•	•													82
BUPPKB__		Base Utensil Pantry Pull-out w/Knife Block				•	•												82
BWB__		Base Wastebasket					•	•	•										80
BWB__FH		Base Wastebasket Full Height					•	•	•										81
CNTYSB__CM		Country Sink Base w/CabMat™										•	•	•					73
SB__CM		Sink Base CabMat™										•	•	•					69
SB__STCM		Sink Base w/Tilt-out Trays and CabMat™										•	•	•					70
SB36STS		Sink Base SuperCabinet™ w/Tilt-out Trays												•					71
SB36STSCM		Sink Base SuperCabinet™ w/Tilt-out Trays and CabMat™												•					71
Vanity Cabinets		Description	3"	6"	9"	12"	15"	18"	21"	24"	27"	30"	33"	36"	39"	42"	45"	48"	Page
L188421BH L or R		Linen Tall Cabinet w/Drawer and Removable Hamper						•											121

• Available widths

TABLE OF CONTENTS – WALL CABINETS

Wall Cabinets 12" High32
Wall Cabinets 15" High33
Wall Cabinets 18" High35
Wall Cabinets 21" High36
Wall Cabinets 24" High37
Wall Cabinets 27" High38
Wall Cabinets 30", 33", or 36" High39
Wall Cabinets 39" or 42" High41
Stacked Wall Cabinets43
Wall Cabinets with Drawers45
Wall Corner Cabinets46
Wall Organization and Specialty Cabinets51
Wood Hoods and Blowers57

WALL CABINETS

WALL CABINET NOMENCLATURE

All Wall Cabinets are 12" deep unless otherwise noted.

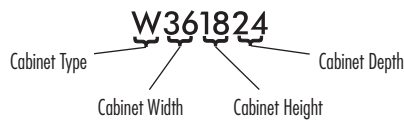

DOOR OPTIONS

Mod.	Description
CG, CG.BTM, CG.TOP	Cut-for-glass Doors
MD, MD.BTM, MD.TOP	Mullion Doors
MFO	Modified Full Overlay

CONSTRUCTION UPGRADES

Mod.	Description
APW	All-plywood Construction
PLE	Plywood Ends

NON SOFT-CLOSE OPTIONS

Mod.	Description
NSCH	Non Soft-close Door Hinges

MODIFICATIONS GRID KEY

Mod.	Description
•	Available
STD	Standard on these cabinets
	5 Day Express Response Item

CUSTOM MODIFICATIONS

Mod.	Description
ADDTK*	Add Toekick
AUTHB	Authentic End - Both
AUTHL	Authentic End - Left
AUTHR	Authentic End - Right
CBO	Cabinet Box Only
CCO	Cabinet Case Only
CFNTO	Cabinet Front Only
CFRMO	Cabinet Frame Only
CND	Cabinet with No Door, with Drawer
FB	Finished Ends
FPEB	Furniture Finished Plywood End Panels
ID	Increased Depth
MIP	Matching Interior Plywood
P	Peninsula
RD	Reduced Depth

*ADDTK available with compatible toekick modifications.

When varying heights, make sure to also vary depths to allow moulding to end into adjacent side of cabinet. Vary depths at least 3" when varying heights.

Use FPEB modification or apply an end panel skin to create a flush end on the side of a wall cabinet if installed at the end of a run for ease of moulding installation.

FPEB modification is recommended for non-stacking applications. Use a 1/4" skin for stacking applications.

WALL SINGLE DOOR, 12" HIGH

12", 15", 18", 21", or 24"

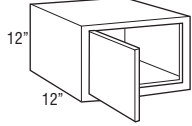

Price Point

	1	2	3	4	5	6	7	8	9	10	11
W1212 L or R	298	314	345	368	400	416	423	454	464	504	545
W1512 L or R	319	332	368	394	425	441	448	483	493	538	581
W1812 L or R	338	356	390	417	452	470	475	515	526	572	619
W2112 L or R	357	376	413	441	478	497	504	545	556	603	653
W2412 L or R	376	396	434	464	503	522	532	574	586	634	688

Custom Modifications

ADDTK	AUTH	CBO	CCO	CFNTO	CFRMO	CND	FB	FPEB	ID	MIP	P	RD
• ¹	•		•	•	•		•	•	•	•	•	•

Construction Upgrades

APW	PLE
•	•

Door Options

CG	CG.BTM	CG.TOP	MD	MD.BTM	MD.TOP	MFO
•						•

Non Soft-close Options

NSCH
•

¹ Not available on 21" or 24" wide

WALL DOUBLE DOOR, 12" HIGH

24", 27", 30", 31 1/2", 33", 36", or 37"

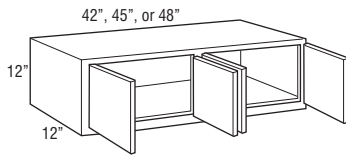
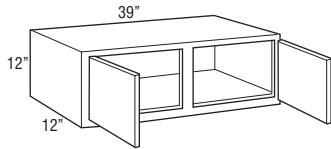
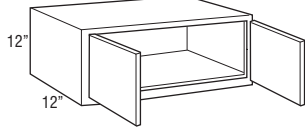

W2412	380	400	438	469	508	528	538	580	592	641	695
W2712	387	407	448	476	518	538	548	591	603	656	712
W3012	397	417	460	489	529	549	560	604	618	671	727
W31.512	402	422	465	495	535	555	567	611	625	679	735
W3312	406	426	470	501	540	560	573	618	631	686	742
W3612	428	450	493	530	572	593	604	651	665	725	784
W3712	442	463	506	544	586	608	621	669	683	744	807

W3912	448	473	519	555	599	621	632	683	697	758	820
--------------	-----	-----	-----	-----	-----	-----	-----	-----	-----	-----	-----

W4212	470	493	545	582	629	652	665	717	732	797	861
W4512	491	516	566	605	655	679	693	749	764	829	900
W4812	601	632	699	745	806	836	851	916	935	1021	1087

Custom Modifications

ADDTK	AUTH	CBO	CCO	CFNTO	CFRMO	CND	FB	FPEB	ID	MIP	P	RD
•	•		•	•	•		•	•	•	•	•	•

Construction Upgrades

APW	PLE
•	•

Door Options

CG	CG.BTM	CG.TOP	MD	MD.BTM	MD.TOP	MFO
•						•

Non Soft-close Options

NSCH
•

WALL TOP HINGE, 12" HIGH

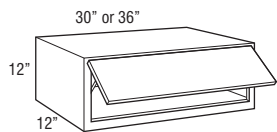

	Price Point	1	2	3	4	5	6	7	8	9	10	11
WTH3012		484	509	562	599	649	674	688	737	753	820	889
WTH3612		535	564	618	661	714	741	755	814	830	905	980

- 30"-36" wide use non-standard configuration doors. See Door Style Specifications page in Door Style section for details on doors with grain pattern exceptions.
- Cabinet may utilize one or two lift mechanisms depending on door size and weight. Door lift mechanism tension can be field adjusted.
- Depth can be reduced to a minimum of 9".
- Lift mechanisms and mounting brackets will be visible if used with transparent textured glass.
- Lift mechanism not available for order for field installation, only available factory installed.
- When textured glass is ordered for use in wall top hinge cabinets, glass design will be turned horizontally and may match desired pattern.
- Door will open a maximum of 107° due to hinges. For applications close to a ceiling, door angle can be restricted to 86° with a Hinge Angle Restriction Clip (HINGERESCLIP, see page 156).

Custom Modifications

ADDTK	AUTH	CBO	CCO	CFNTO	CFRMO	CND	FB	FPEB	ID	MIP	P	RD
	•		•		•		•	•	•	•		•

Construction Upgrades

APW	PLE
•	•

Door Options

CG	CG.BTM	CG.TOP	MD	MD.BTM	MD.TOP	MFO
•						•

Non Soft-close Options

NSCH

WALL REFRIGERATOR DOUBLE DOOR, 12" HIGH, 24" DEEP

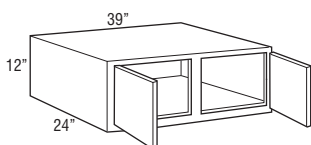
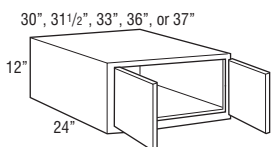

W301224	443	465	512	546	590	612	624	670	684	749	810
W31.51224	466	489	539	575	621	644	657	706	721	787	852
W331224	489	513	565	603	651	676	690	742	758	825	893
W361224	510	538	592	631	683	708	722	779	795	864	936
W371224	524	549	605	646	698	725	739	797	814	884	957

W391224	529	555	614	656	708	734	750	808	825	898	972
----------------	-----	-----	-----	-----	-----	-----	-----	-----	-----	-----	-----

- 24" deep cabinets must be fully supported by screws installed in a structural member in the ceiling or soffit, and into adjacent cabinets or tall panels.
- Load limit is 15 lbs. per square foot of load bearing surface.

Custom Modifications

ADDTK	AUTH	CBO	CCO	CFNTO	CFRMO	CND	FB	FPEB	ID	MIP	P	RD
•	•		•	•	•		•	•	•	•		•

Construction Upgrades

APW	PLE
•	•

Door Options

CG	CG.BTM	CG.TOP	MD	MD.BTM	MD.TOP	MFO
•						•

Non Soft-close Options

NSCH
•

WALL SINGLE DOOR, 15" HIGH

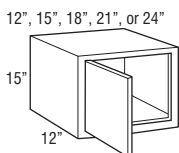

W1215 L or R	325	343	376	400	433	450	460	497	507	547	593
W1515 L or R	345	363	400	427	462	480	487	526	537	583	631
W1815 L or R	367	386	424	452	489	508	517	558	569	619	668
W2115 L or R	376	394	433	463	500	519	530	572	584	632	686
W2415 L or R	388	407	446	478	518	538	547	590	602	655	709

Custom Modifications

ADDTK	AUTH	CBO	CCO	CFNTO	CFRMO	CND	FB	FPEB	ID	MIP	P	RD
• ¹	•		•	•	•		•	•	•	•		•

Construction Upgrades

APW	PLE
•	•

Door Options

CG	CG.BTM	CG.TOP	MD	MD.BTM	MD.TOP	MFO
•			• ²			•

Non Soft-close Options

NSCH
•

¹ Not available on 21" or 24" wide

² Not available on 12" wide

WALL DOUBLE DOOR, 15" HIGH

24", 27", 30", 31 1/2", 33", 36", or 37"

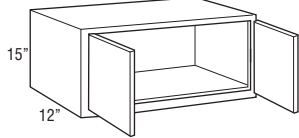

39", or 42"

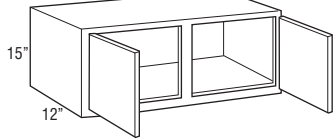

42", 45", or 48"

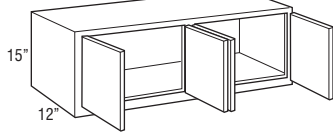

Price Point	1	2	3	4	5	6	7	8	9	10	11
W2415	391	412	451	482	524	544	553	595	608	661	716
W2715	405	424	468	499	538	558	571	616	629	681	737
W3015	415	436	480	512	555	576	587	633	647	702	760
W31.515	427	449	494	527	570	591	603	650	663	721	780
W3315	438	462	507	541	584	605	619	666	679	740	800
W3615	460	482	531	569	615	639	651	699	714	779	844
W3715	471	493	545	583	631	655	668	716	731	798	865

W3915	482	507	555	597	644	668	681	736	752	816	883
W4215CS	492	517	566	610	658	681	695	751	767	833	901

W4215	504	531	587	625	678	705	717	771	787	858	927
W4515	528	554	612	655	707	733	749	802	819	894	968
W4815	648	679	750	801	866	898	916	967	1007	1098	1147

• W4215CS has two doors. W4215 has four doors.

Custom Modifications

ADDTK	AUTH	CBO	CCO	CFNTO	CFRMO	CND	FB	FPEB	ID	MIP	P	RD
• ¹	•		•	•	•		•	•	•	•	•	•

Construction Upgrades

APW	PLE
•	•

Door Options

CG	CG.BTM	CG.TOP	MD	MD.BTM	MD.TOP	MFO
•			• ²			•

Non Soft-close Options

NSCH
•

¹ Not available on W4215CS

² Not available on 37", 39", or 45" wide or W4215

WALL TOP HINGE, 15" HIGH

30" or 36"

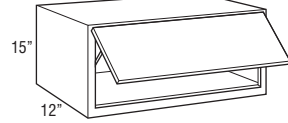

WTH3015	520	545	600	643	694	720	733	792	809	877	952
WTH3615	575	603	665	712	769	797	814	875	893	973	1053

- 30"-36" wide use non-standard configuration doors. See Door Style Specifications page in Door Style section for details on doors with grain pattern exceptions.
- Cabinet may utilize one or two lift mechanisms depending on door size and weight. Door lift mechanism tension can be field adjusted.
- Depth can be reduced to a minimum of 9".
- Lift mechanisms and mounting brackets will be visible if used with transparent textured glass.
- Lift mechanism not available for order for field installation, only available factory installed.
- When textured glass is ordered for use in wall top hinge cabinets, glass design will be turned horizontally and may match desired pattern.
- Door will open a maximum of 107° due to hinges. For applications close to a ceiling, door angle can be restricted to 86° with a Hinge Angle Restriction Clip (HINGERESCLIP, see page 156).

Custom Modifications

ADDTK	AUTH	CBO	CCO	CFNTO	CFRMO	CND	FB	FPEB	ID	MIP	P	RD
	•		•		•		•	•	•	•	•	•

Construction Upgrades

APW	PLE
•	•

Door Options

CG	CG.BTM	CG.TOP	MD	MD.BTM	MD.TOP	MFO
•						•

Non Soft-close Options

NSCH

WALL REFRIGERATOR DOUBLE DOOR, 15" HIGH, 24" DEEP

30", 31 1/2", 33", 36", or 37"

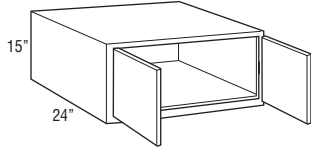

39"

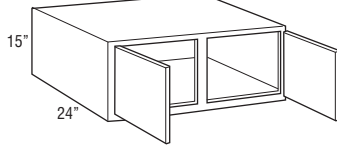

W301524	474	500	548	585	632	656	668	721	735	801	868
W31.51524	486	511	563	602	650	674	686	740	755	824	890
W331524	498	522	578	618	667	692	703	759	774	846	912
W361524	526	552	610	649	702	728	740	799	816	890	960
W371524	538	566	627	665	721	749	759	820	837	911	984

W391524	549	580	636	679	736	764	778	835	852	933	1006
----------------	-----	-----	-----	-----	-----	-----	-----	-----	-----	-----	------

- 24" deep cabinets must be fully supported by screws installed in a structural member in the ceiling or soffit, and into adjacent cabinets or tall panels.
- Load limit is 15 lbs. per square foot of load bearing surface.

Custom Modifications

ADDTK	AUTH	CBO	CCO	CFNTO	CFRMO	CND	FB	FPEB	ID	MIP	P	RD
•	•		•	•	•		•	•	•	•	•	•

Construction Upgrades

APW	PLE
•	•

Door Options

CG	CG.BTM	CG.TOP	MD	MD.BTM	MD.TOP	MFO
•			• ¹			•

Non Soft-close Options

NSCH
•

¹ Not available on 37" or 39" wide

WALL SINGLE DOOR, 18" HIGH

12", 15", 18", 21", or 24"

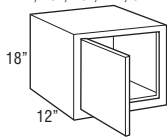

	Price Point	1	2	3	4	5	6	7	8	9	10	11
W1218 L or R		311	328	362	386	418	434	441	474	484	530	572
W1518 L or R		331	348	385	410	442	457	469	504	515	559	605
W1818 L or R		350	368	406	434	468	484	496	534	545	592	640
W2118 L or R		373	391	433	462	499	517	526	566	578	629	683
W2418 L or R		376	395	435	466	503	521	532	573	585	637	690

Custom Modifications

ADDTK	AUTH	CBO	CCO	CFNTO	CFRMO	CND	FB	FPEB	ID	MIP	P	RD
•	•		•	•	•		•	•	•	•	•	•

Construction Upgrades

APW	PLE
•	•

Door Options

CG	CG.BTM	CG.TOP	MD	MD.BTM	MD.TOP	MFO
•			• ¹			•

Non Soft-close Options

NSCH
•

¹ Not available on 12" wide

WALL DOUBLE DOOR, 18" HIGH

24", 27", 30", 31 1/2", 33", 36", or 37"

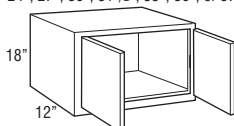

39", 42", 45", or 48"

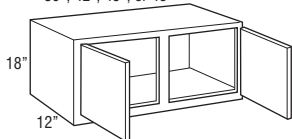

W2418	414	435	479	511	553	574	586	630	643	700	759
W2718	428	448	493	528	571	592	603	649	662	723	783
W3018	448	473	519	555	599	621	632	683	697	759	820
W31.518	459	482	531	566	611	634	646	698	712	774	839
W3318	469	491	543	576	623	647	660	713	727	789	857
W3618	492	518	568	608	656	680	694	750	765	833	901
W3718	503	530	583	623	672	697	712	769	784	855	923

W3918	518	544	597	638	689	715	730	786	802	874	947
W4218	544	572	629	670	725	752	767	826	843	918	994
W4518	568	596	656	699	756	784	799	863	881	956	1040
W4818CS	655	702	773	829	898	931	952	1001	1049	1145	1189

Custom Modifications

ADDTK	AUTH	CBO	CCO	CFNTO	CFRMO	CND	FB	FPEB	ID	MIP	P	RD
•	•		•	•	•		•	•	•	•	•	•

Construction Upgrades

APW	PLE
•	•

Door Options

CG	CG.BTM	CG.TOP	MD	MD.BTM	MD.TOP	MFO
•			• ¹			•

Non Soft-close Options

NSCH
•

¹ Not available on 37" or 39" wide

WALL TOP HINGE, 18" HIGH

30" or 36"

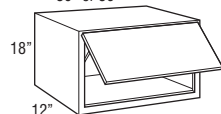

WTH3018	562	590	648	692	748	776	790	852	870	950	1023
WTH3618	615	647	711	761	821	851	867	936	955	1043	1127

- 30"-36" wide use non-standard configuration doors. See Door Style Specifications page in Door Style section for details on doors with grain pattern exceptions.
- Cabinet may utilize one or two lift mechanisms depending on door size and weight. Door lift mechanism tension can be field adjusted.
- Depth can be reduced to a minimum of 9".
- Lift mechanisms and mounting brackets will be visible if used with transparent textured glass.
- Lift mechanism not available for order for field installation, only available factory installed.
- When textured glass is ordered for use in wall top hinge cabinets, glass design will be turned horizontally and may match desired pattern.
- Door will open a maximum of 107° due to hinges. For applications close to a ceiling, door angle can be restricted to 86° with a Hinge Angle Restriction Clip (HINGERESCLIP; see page 156).

Custom Modifications

ADDTK	AUTH	CBO	CCO	CFNTO	CFRMO	CND	FB	FPEB	ID	MIP	P	RD
	•		•		•		•	•	•	•		•

Construction Upgrades

APW	PLE
•	•

Door Options

CG	CG.BTM	CG.TOP	MD	MD.BTM	MD.TOP	MFO
•						•

Non Soft-close Options

NSCH

WALL REFRIGERATOR DOUBLE DOOR, 18" HIGH, 24" DEEP

30", 31 1/2", 33", 36", or 37"

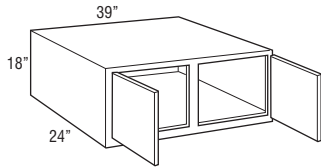
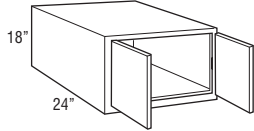

Price Point

	1	2	3	4	5	6	7	8	9	10	11
W301824	511	539	592	632	683	708	722	779	795	864	936
W31.51824	522	551	604	645	697	723	738	795	811	884	957
W331824	532	562	616	658	711	737	753	810	827	903	977
W361824	560	590	648	690	746	774	790	852	870	948	1026
W371824	574	602	665	708	767	795	809	872	890	972	1052

W391824	586	618	683	727	787	816	830	896	914	996	1079
----------------	-----	-----	-----	-----	-----	-----	-----	-----	-----	-----	------

- 24" deep cabinets must be fully supported by screws installed in a structural member in the ceiling or soffit, and into adjacent cabinets or tall panels.
- Load limit is 15 lbs. per square foot of load bearing surface.

Custom Modifications

ADDTK	AUTH	CBO	CCO	CFNTO	CFRMO	CND	FB	FPEB	ID	MIP	P	RD
•	•		•	•		•		•		•		•

Construction Upgrades

APW	PLE
•	•

Door Options

CG	CG.BTM	CG.TOP	MD	MD.BTM	MD.TOP	MFO
•			• ¹			•

Non Soft-close Options

NSCH
•

¹ Not available on 37" or 39" wide

WALL SINGLE DOOR, 21" HIGH

12", 15", 18", 21", or 24"

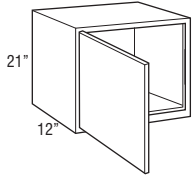

W1221 L or R	338	356	389	417	452	470	475	513	525	572	620
W1521 L or R	345	362	400	427	462	480	485	524	535	583	632
W1821 L or R	372	391	433	460	497	515	522	566	578	629	680
W2121 L or R	405	425	469	499	539	559	572	616	629	684	739
W2421 L or R	438	462	508	541	585	608	620	667	680	740	800

Custom Modifications

ADDTK	AUTH	CBO	CCO	CFNTO	CFRMO	CND	FB	FPEB	ID	MIP	P	RD
•	•		•	•		•		•		•		•

Construction Upgrades

APW	PLE
•	•

Door Options

CG	CG.BTM	CG.TOP	MD	MD.BTM	MD.TOP	MFO
•						•

Non Soft-close Options

NSCH
•

WALL DOUBLE DOOR, 21" HIGH

24", 27", 30", 31 1/2", 33", 36", or 37"

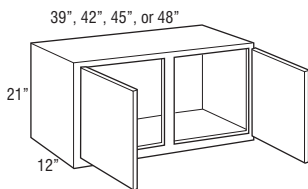
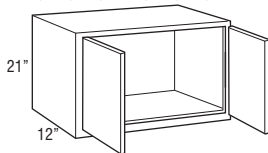

W2421	483	508	556	596	644	668	680	733	749	815	883
W2721	491	515	566	604	655	679	693	748	763	826	900
W3021	496	520	573	612	660	684	698	754	770	835	908
W31.521	507	532	586	625	675	700	714	772	788	855	928
W3321	518	544	599	638	689	715	730	789	806	875	947
W3621	541	568	629	668	724	752	765	824	840	916	992
W3721	554	583	643	686	742	769	783	840	857	937	1015

W3921	572	601	661	707	765	793	808	871	889	968	1047
W4221	600	631	698	743	804	833	848	914	933	1016	1101
W4521	624	656	724	773	836	866	883	952	972	1054	1143
W4821CS	718	776	860	920	974	1001	1035	1069	1133	1224	1268

Custom Modifications

ADDTK	AUTH	CBO	CCO	CFNTO	CFRMO	CND	FB	FPEB	ID	MIP	P	RD
•	•		•	•		•		•		•		•

Construction Upgrades

APW	PLE
•	•

Door Options

CG	CG.BTM	CG.TOP	MD	MD.BTM	MD.TOP	MFO
•						•

Non Soft-close Options

NSCH
•

WALL TOP HINGE, 21" HIGH

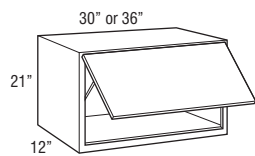

	Price Point	1	2	3	4	5	6	7	8	9	10	11
WTH3021		718	754	830	885	959	995	1014	1092	1115	1210	1316
WTH3621		786	825	911	970	1050	1089	1109	1197	1221	1328	1440

- 30"-36" wide use non-standard configuration doors. See Door Style Specifications page in Door Style section for details on doors with grain pattern exceptions.
- Lid stay hinge will be installed on the left side of the cabinet.
- Cabinet may utilize one or two lift mechanisms depending on door size and weight. Door lift mechanism tension can be field adjusted.
- Depth can be reduced to a minimum of 9".
- Lift mechanisms and mounting brackets will be visible if used with transparent textured glass.
- Lift mechanisms not available for order for field installation, only available factory installed.
- When textured glass is ordered for use in wall top hinge cabinets, glass design will be turned horizontally and may match desired pattern.
- Door will open a maximum of 107° due to hinges. For applications close to a ceiling, door angle can be restricted to 86° with a Hinge Angle Restriction Clip (HINGERESCLIP, see page 156).

Custom Modifications

ADDTK	AUTH	CBO	CCO	CFNTO	CFRMO	CND	FB	FPEB	ID	MIP	P	RD
	•		•		•		•	•	•	•		•

Construction Upgrades

APW	PLE
•	•

Door Options

CG	CG.BTM	CG.TOP	MD	MD.BTM	MD.TOP	MFO
•						•

Non Soft-close Options

NSCH

WALL REFRIGERATOR DOUBLE DOOR, 21" HIGH, 24" DEEP

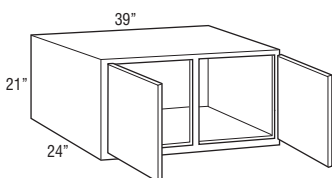
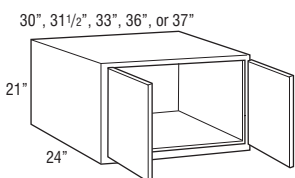

W302124	566	593	656	695	753	782	797	860	877	954	1032
W31.52124	577	606	670	711	770	799	814	881	899	977	1056
W332124	587	619	683	727	787	816	830	901	920	1000	1079
W362124	618	648	714	762	825	856	872	938	957	1045	1132
W372124	632	664	728	778	845	879	893	959	979	1069	1157

W392124	651	687	755	805	871	903	921	991	1011	1104	1193
----------------	-----	-----	-----	-----	-----	-----	-----	-----	------	------	------

- 24" deep cabinets must be fully supported by screws installed in a structural member in the ceiling or soffit, and into adjacent cabinets or tall panels.
- Load limit is 15 lbs. per square foot of load bearing surface.

Custom Modifications

ADDTK	AUTH	CBO	CCO	CFNTO	CFRMO	CND	FB	FPEB	ID	MIP	P	RD
•	•		•	•	•		•	•	•	•		•

Construction Upgrades

APW	PLE
•	•

Door Options

CG	CG.BTM	CG.TOP	MD	MD.BTM	MD.TOP	MFO
•						•

Non Soft-close Options

NSCH
•

WALL SINGLE DOOR, 24" HIGH

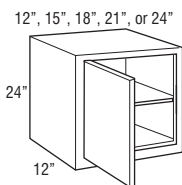

W1224 L or R	347	364	401	429	465	483	493	512	541	588	609
W1524 L or R	356	373	412	440	474	491	502	522	553	602	622
W1824 L or R	382	404	444	472	503	519	539	549	583	630	653
W2124 L or R	415	437	481	512	552	571	588	603	647	692	721
W2424 L or R	441	476	522	556	569	576	594	612	651	698	730

Custom Modifications

ADDTK	AUTH	CBO	CCO	CFNTO	CFRMO	CND	FB	FPEB	ID	MIP	P	RD
•	•	•	•	•	•		•	•	•	•		•

Construction Upgrades

APW	PLE
•	•

Door Options

CG	CG.BTM	CG.TOP	MD	MD.BTM	MD.TOP	MFO
•			• ¹			•

Non Soft-close Options

NSCH
•

¹ Not available on 12" wide

WALL DOUBLE DOOR, 24" HIGH

24", 27", 30", 31 1/2", 33", 36", or 37"

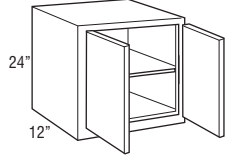

39", 42", 45", or 48"

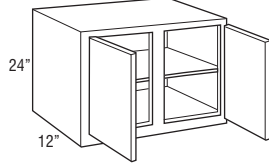

Price Point

	1	2	3	4	5	6	7	8	9	10	11
W2424	498	522	575	615	665	689	700	756	772	840	910
W2724	511	539	593	633	684	709	723	780	796	867	938
W3024	537	565	620	662	716	743	758	817	834	908	982
W31.524	575	604	664	708	766	795	811	875	893	970	1051
W3324	560	590	648	693	749	776	791	852	870	948	1028
W3624	592	620	684	730	788	817	833	900	919	1001	1080
W3724	608	634	702	748	808	837	854	924	944	1026	1106

W3924	620	652	716	765	829	861	874	942	961	1049	1135
W4224	651	685	753	805	871	903	921	991	1011	1101	1196
W4524	679	714	788	838	908	941	957	1032	1053	1148	1245
W4824CS	791	848	935	1002	1054	1080	1126	1173	1246	1380	1437

Custom Modifications

ADDTK	AUTH	CBO	CCO	CFNTO	CFRMO	CND	FB	FPEB	ID	MIP	P	RD
•	•	•	•	•	•	•	•	•	•	•	•	•

Construction Upgrades

APW	PLE
•	•

Door Options

CG	CG.BTM	CG.TOP	MD	MD.BTM	MD.TOP	MFO
•			• ¹			•

Non Soft-close Options

NSCH
•

¹ Not available on 37" or 39" wide

WALL REFRIGERATOR DOUBLE DOOR, 24" HIGH, 24" DEEP

30", 31 1/2", 33", 36", or 37"

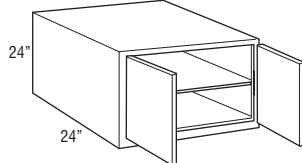

39"

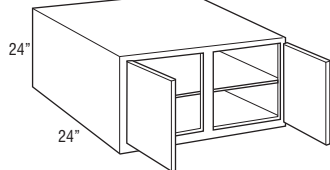

W302424	582	612	675	722	780	808	824	889	907	987	1069
W31.52424	597	628	691	738	798	827	844	911	930	1010	1095
W332424	612	643	707	754	816	846	864	933	952	1032	1120
W362424	674	707	777	832	899	931	951	1023	1044	1138	1231
W372424	705	740	812	871	940	975	995	1069	1091	1192	1287

W392424	706	744	819	872	944	979	997	1076	1098	1198	1294
----------------	-----	-----	-----	-----	-----	-----	-----	------	------	------	------

- 24" deep cabinets must be fully supported by screws installed in a structural member in the ceiling or soffit, and into adjacent cabinets or tall panels.
- Shelf is 21" deep on W392424 to allow for the shelf to be removed from the cabinet.
- Load limit is 15 lbs. per square foot of load bearing surface.

Custom Modifications

ADDTK	AUTH	CBO	CCO	CFNTO	CFRMO	CND	FB	FPEB	ID	MIP	P	RD
•	•	•	•	•	•	•	•	•	•	•	•	•

Construction Upgrades

APW	PLE
•	•

Door Options

CG	CG.BTM	CG.TOP	MD	MD.BTM	MD.TOP	MFO
•			• ¹			•

Non Soft-close Options

NSCH
•

¹ Not available on 37" or 39" wide

WALL SINGLE DOOR, 27" HIGH

12", 15", 18", 21", or 24"

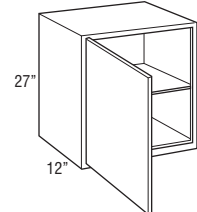

W1227 L or R	359	376	413	442	478	496	507	545	556	605	658
W1527 L or R	382	403	443	472	510	529	541	585	597	649	700
W1827 L or R	412	434	479	509	549	569	581	627	640	696	753
W2127 L or R	448	473	520	555	599	621	633	683	697	759	821
W2427 L or R	483	518	571	608	647	667	695	722	765	834	857

Custom Modifications

ADDTK	AUTH	CBO	CCO	CFNTO	CFRMO	CND	FB	FPEB	ID	MIP	P	RD
•	•	•	•	•	•	•	•	•	•	•	•	•

Construction Upgrades

APW	PLE
•	•

Door Options

CG	CG.BTM	CG.TOP	MD	MD.BTM	MD.TOP	MFO
•						•

Non Soft-close Options

NSCH
•

WALL DOUBLE DOOR, 27" HIGH

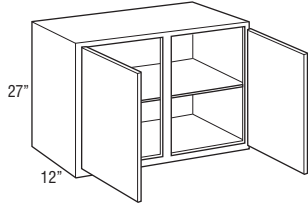
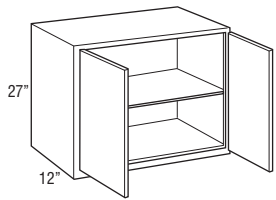

	Price Point	1	2	3	4	5	6	7	8	9	10	11
W2427		536	563	620	662	715	741	756	815	832	907	979
W2727		552	581	639	683	739	765	779	843	861	935	1011
W3027		568	596	656	699	756	784	799	863	881	956	1040
W3327		593	623	685	732	792	823	837	902	921	1002	1084
W3627		624	656	723	771	834	864	879	950	969	1052	1140
W3727		640	672	742	789	852	883	900	975	995	1078	1169

W3927	656	689	758	808	873	905	923	995	1015	1107	1198
W4227	687	724	796	849	919	954	970	1047	1068	1164	1260
W4527	713	751	826	884	956	991	1010	1088	1110	1209	1312
W4827CS	824	895	988	1057	1117	1146	1187	1225	1301	1402	1453

Custom Modifications

ADDTK	AUTH	CBO	CCO	CFNTO	CFRMO	CND	FB	FPEB	ID	MIP	P	RD
•	•	•	•	•	•	•	•	•	•	•	•	•

Construction Upgrades

APW	PLE
•	•

Door Options

CG	CG.BTM	CG.TOP	MD	MD.BTM	MD.TOP	MFO
•						•

Non Soft-close Options

NSCH
•

WALL REFRIGERATOR DOUBLE DOOR, 27" HIGH, 24" DEEP

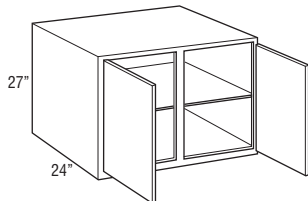
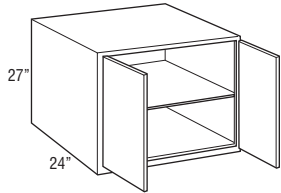

W302724	692	727	799	855	923	957	976	1051	1072	1169	1265
W332724	722	759	835	894	966	1002	1021	1099	1122	1222	1322
W362724	761	799	880	939	1015	1053	1075	1159	1182	1286	1392
W372724	781	819	903	963	1041	1079	1103	1188	1212	1319	1425

W392724	799	838	924	987	1068	1108	1131	1219	1244	1350	1462
----------------	-----	-----	-----	-----	------	------	------	------	------	------	------

- 24" deep cabinets must be fully supported by screws installed in a structural member in the ceiling or soffit, and into adjacent cabinets or tall panels.
- Load limit is 15 lbs. per square foot of load bearing surface.

Custom Modifications

ADDTK	AUTH	CBO	CCO	CFNTO	CFRMO	CND	FB	FPEB	ID	MIP	P	RD
•	•	•	•	•	•	•	•	•	•	•	•	•

Construction Upgrades

APW	PLE
•	•

Door Options

CG	CG.BTM	CG.TOP	MD	MD.BTM	MD.TOP	MFO
•						•

Non Soft-close Options

NSCH
•

WALL SINGLE DOOR, 30" HIGH

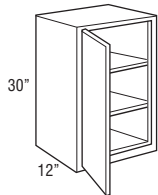

W930 L or R	347	364	403	428	464	482	491	527	538	586	634
W1230 L or R	370	389	426	456	493	512	521	560	572	625	677
W1530 L or R	394	414	456	490	529	548	558	586	615	667	696
W1830 L or R	423	445	491	526	567	588	597	636	659	718	752
W2130 L or R	461	484	537	572	618	640	653	688	717	783	819
W2430 L or R	501	527	582	620	670	695	706	761	777	847	916

Custom Modifications

ADDTK	AUTH	CBO	CCO	CFNTO	CFRMO	CND	FB	FPEB	ID	MIP	P	RD
•	•	•	•	•	•	•	•	•	•	•	•	•

Construction Upgrades

APW	PLE
•	•

Door Options

CG	CG.BTM	CG.TOP	MD	MD.BTM	MD.TOP	MFO
•			• ¹			•

Non Soft-close Options

NSCH
•

¹ Not available on 9" or 12" wide

WALL DOUBLE DOOR, 30" HIGH

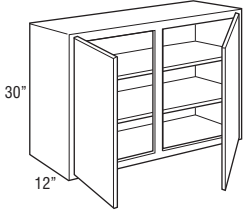
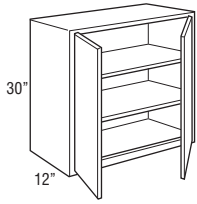

	Price Point	1	2	3	4	5	6	7	8	9	10	11
W2430		552	582	639	684	739	765	780	840	857	935	1011
W2730		569	597	659	702	759	787	801	867	885	961	1043
W3030		597	629	690	736	797	827	843	908	927	1010	1091
W3330		624	656	723	771	834	864	879	950	969	1052	1140
W3630		655	687	758	808	873	905	923	995	1015	1106	1198
W3930		689	724	797	851	920	955	973	1049	1070	1166	1262
W4230		723	760	837	894	967	1003	1022	1103	1125	1225	1324
W4530		786	827	912	974	1053	1092	1110	1200	1225	1332	1442
W4830CS		870	942	1041	1117	1184	1217	1280	1346	1409	1538	1600

Custom Modifications

ADDTK	AUTH	CBO	CCO	CFNTO	CFRMO	CND	FB	FPEB	ID	MIP	P	RD
•	•	•	•	•	•	•	•	•	•	•	•	•

Construction Upgrades

APW	PLE
•	•

Door Options

CG	CG.BTM	CG.TOP	MD	MD.BTM	MD.TOP	MFO
•	•	•	• ¹	•	•	•

Non Soft-close Options

NSCH
•

¹ Not available on 39" wide

WALL SINGLE DOOR, 33" HIGH

9", 12", 15", 18", 21", or 24"

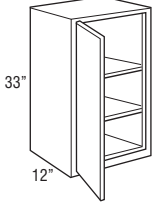

W933 L or R	386	405	444	476	515	534	545	587	600	650	706
W1233 L or R	412	434	474	507	549	571	582	625	639	696	753
W1533 L or R	440	463	507	544	586	608	620	659	683	743	781
W1833 L or R	472	497	547	583	631	655	667	717	732	797	845
W2133 L or R	513	540	596	636	688	714	730	774	798	871	919
W2433 L or R	557	587	644	689	745	773	787	849	867	942	1021

Custom Modifications

ADDTK	AUTH	CBO	CCO	CFNTO	CFRMO	CND	FB	FPEB	ID	MIP	P	RD
•	•	•	•	•	•	•	•	•	•	•	•	•

Construction Upgrades

APW	PLE
•	•

Door Options

CG	CG.BTM	CG.TOP	MD	MD.BTM	MD.TOP	MFO
•	•	•	• ¹	•	•	•

Non Soft-close Options

NSCH
•

¹ Not available on 9" or 12" wide

WALL DOUBLE DOOR, 33" HIGH

24", 27", 30", 33", or 36"

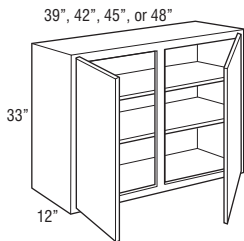
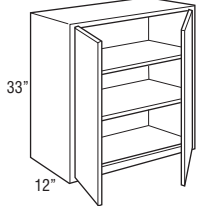

W2433	621	655	717	769	832	862	876	944	963	1051	1136
W2733	642	676	744	791	856	889	907	978	998	1086	1174
W3033	672	708	778	830	898	931	949	1022	1043	1138	1230
W3333	704	740	814	868	940	975	992	1070	1092	1189	1286
W3633	740	777	856	913	987	1023	1044	1126	1150	1250	1352
W3933	798	839	923	987	1068	1108	1128	1217	1241	1353	1462
W4233	839	881	972	1035	1120	1162	1185	1277	1303	1420	1536
W4533	913	959	1057	1126	1220	1266	1288	1392	1420	1547	1674
W4833CS	1007	1099	1212	1296	1374	1412	1460	1508	1600	1729	1791

Custom Modifications

ADDTK	AUTH	CBO	CCO	CFNTO	CFRMO	CND	FB	FPEB	ID	MIP	P	RD
•	•	•	•	•	•	•	•	•	•	•	•	•

Construction Upgrades

APW	PLE
•	•

Door Options

CG	CG.BTM	CG.TOP	MD	MD.BTM	MD.TOP	MFO
•	•	•	• ¹	•	•	•

Non Soft-close Options

NSCH
•

¹ Not available on 39" wide

WALL SINGLE DOOR, 36" HIGH

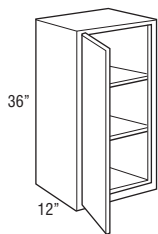

	Price Point	1	2	3	4	5	6	7	8	9	10	11
W936 L or R		394	414	456	490	529	548	558	603	615	667	723
W1236 L or R		422	444	485	519	564	586	595	641	655	714	772
W1536 L or R		451	475	520	555	601	623	634	686	700	761	824
W1836 L or R		483	508	562	599	647	671	684	736	752	817	886
W2136 L or R		527	553	611	652	705	732	748	802	819	893	967
W2436 L or R		572	601	660	707	764	792	807	871	889	967	1047

Custom Modifications

ADDTK	AUTH	CBO	CCO	CFNTO	CFRMO	CND	FB	FPEB	ID	MIP	P	RD
•	•	•	•	•	•	•	•	•	•	•	•	•

Construction Upgrades

APW	PLE
•	•

Door Options

CG	CG.BTM	CG.TOP	MD	MD.BTM	MD.TOP	MFO
•	•	•	• ¹	•	•	•

Non Soft-close Options

NSCH
•

¹ Not available on 9" or 12" wide

WALL DOUBLE DOOR, 36" HIGH

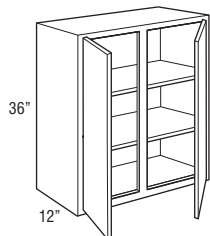
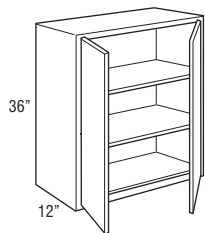

W2436	638	671	737	788	853	884	901	970	991	1080	1169
W2736	661	697	764	815	882	914	933	1005	1025	1116	1207
W3036	692	727	800	855	923	957	976	1051	1072	1171	1265
W3336	723	760	836	893	966	1002	1021	1100	1123	1222	1323
W3636	761	799	880	939	1015	1053	1075	1159	1182	1286	1392

W3936	826	868	956	1020	1105	1146	1168	1258	1284	1400	1512
W4236	868	913	1004	1072	1157	1200	1226	1321	1348	1470	1591
W4536	945	992	1094	1165	1262	1309	1332	1440	1469	1600	1731
W4836CS	1082	1140	1256	1341	1453	1509	1538	1661	1695	1852	1984

Custom Modifications

ADDTK	AUTH	CBO	CCO	CFNTO	CFRMO	CND	FB	FPEB	ID	MIP	P	RD
•	•	•	•	•	•	•	•	•	•	•	•	•

Construction Upgrades

APW	PLE
•	•

Door Options

CG	CG.BTM	CG.TOP	MD	MD.BTM	MD.TOP	MFO
•	•	•	• ¹	•	•	•

Non Soft-close Options

NSCH
•

¹ Not available on 39" wide

WALL SINGLE DOOR, 39" or 42" HIGH

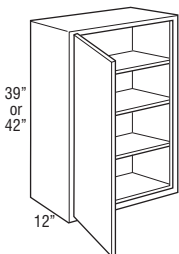

W939 L or R	418	442	484	518	562	583	592	639	652	708	768
W1239 L or R	448	473	518	554	599	621	632	681	696	756	820
W1539 L or R	478	503	553	590	639	664	675	727	742	810	874
W1839 L or R	513	539	595	633	685	711	725	780	796	867	939
W2139 L or R	560	588	647	692	748	776	791	852	870	947	1023
W2439 L or R	608	638	702	750	810	840	857	924	944	1025	1110
W942 L or R	444	469	513	548	593	615	627	675	689	752	812
W1242 L or R	473	500	547	585	632	656	668	721	735	799	866
W1542 L or R	503	529	586	623	676	703	715	769	784	856	926
W1842 L or R	541	568	629	668	724	752	765	824	840	916	992
W2142 L or R	593	623	685	732	792	823	837	902	921	1002	1084
W2442 L or R	642	674	741	791	857	890	907	978	998	1085	1173

Custom Modifications

ADDTK	AUTH	CBO	CCO	CFNTO	CFRMO	CND	FB	FPEB	ID	MIP	P	RD
•	•	•	•	•	•	•	•	•	•	•	•	•

Construction Upgrades

APW	PLE
•	•

Door Options

CG	CG.BTM	CG.TOP	MD	MD.BTM	MD.TOP	MFO
•	•	•	• ¹	•	•	•

Non Soft-close Options

NSCH
•

¹ Not available on 9" or 12" wide

**WALL DOUBLE DOOR,
39" or 42" HIGH**

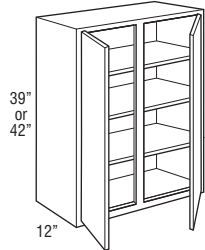
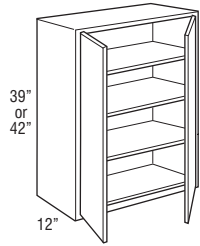

Price Point	1	2	3	4	5	6	7	8	9	10	11
W2439	680	716	788	840	910	944	960	1035	1057	1152	1247
W2739	705	742	818	871	942	977	996	1075	1097	1196	1292
W3039	739	777	855	913	987	1023	1044	1127	1151	1252	1353
W3339	772	811	894	955	1032	1070	1090	1175	1199	1308	1415
W3639	814	855	942	1005	1086	1126	1147	1237	1263	1376	1488
W2442	723	761	837	894	967	1003	1022	1101	1124	1224	1323
W2742	750	789	868	928	1004	1041	1060	1142	1165	1268	1375
W3042	786	826	912	973	1051	1090	1110	1198	1222	1331	1441
W3342	823	862	950	1013	1097	1138	1162	1252	1277	1392	1507
W3642	864	911	998	1070	1155	1197	1221	1316	1343	1462	1584

W3939	877	922	1016	1087	1174	1218	1239	1338	1365	1488	1608
W4239	923	969	1068	1140	1232	1278	1303	1405	1434	1563	1689
W4539	1004	1056	1160	1239	1340	1390	1417	1527	1558	1698	1838
W4839CS	1151	1211	1336	1428	1547	1607	1638	1768	1804	1967	2135
W3942	930	978	1076	1150	1241	1287	1313	1417	1446	1574	1703
W4242	978	1028	1128	1208	1304	1352	1379	1487	1517	1651	1790
W4542	1062	1117	1230	1313	1420	1472	1501	1616	1648	1798	1947
W4842CS	1219	1284	1415	1514	1640	1703	1735	1871	1909	2085	2260

Custom Modifications

ADDTK	AUTH	CBO	CCO	CFNTO	CFRMO	CND	FB	FPEB	ID	MIP	P	RD
•	•	•	•	•	•		•	•	•	•	•	•

Construction Upgrades

APW	PLE
•	•

Door Options

CG	CG.BTM	CG.TOP	MD	MD.BTM	MD.TOP	MFO
•			• ¹			•

Non Soft-close Options

NSCH
•

¹ Not available on 39" wide

STACKED WALL CABINETS SINGLE DOOR, 48", 51", 54", 57", or 60" HIGH

12", 15", 18", 21", or 24"

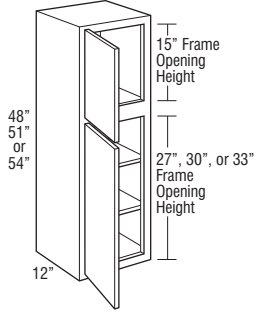

12", 15", 18", 21", or 24"

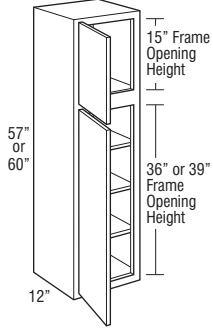

	Price Point	1	2	3	4	5	6	7	8	9	10	11
STW1248 L or R		852	897	985	1053	1139	1183	1203	1293	1320	1444	1562
STW1548 L or R		907	953	1052	1125	1214	1257	1284	1363	1413	1533	1627
STW1848 L or R		967	1017	1122	1200	1294	1340	1367	1463	1505	1638	1740
STW2148 L or R		1043	1094	1213	1293	1397	1447	1474	1568	1619	1765	1878
STW2448 L or R		1097	1153	1272	1358	1467	1520	1548	1668	1703	1855	2008
STW1251 L or R		904	953	1045	1117	1209	1257	1279	1374	1404	1533	1657
STW1551 L or R		964	1014	1115	1193	1285	1332	1362	1454	1498	1628	1733
STW1851 L or R		1028	1082	1192	1272	1374	1424	1454	1564	1597	1737	1857
STW2151 L or R		1108	1164	1287	1373	1484	1539	1570	1675	1720	1875	2003
STW2451 L or R		1167	1228	1349	1444	1560	1618	1649	1778	1815	1974	2139
STW1254 L or R		917	965	1059	1132	1228	1275	1295	1394	1424	1555	1680
STW1554 L or R		978	1029	1132	1207	1304	1350	1379	1488	1519	1650	1787
STW1854 L or R		1042	1095	1210	1292	1394	1444	1475	1588	1622	1762	1908
STW2154 L or R		1125	1180	1305	1393	1505	1562	1593	1710	1747	1903	2063
STW2454 L or R		1185	1245	1369	1467	1584	1642	1674	1805	1843	2005	2172

STW1257 L or R	949	1002	1100	1175	1272	1319	1342	1444	1475	1608	1740
STW1557 L or R	1012	1064	1173	1250	1352	1402	1430	1539	1572	1712	1849
STW1857 L or R	1079	1134	1252	1334	1442	1494	1527	1643	1677	1824	1974
STW2157 L or R	1167	1224	1350	1443	1559	1617	1647	1773	1810	1970	2133
STW2457 L or R	1230	1292	1422	1520	1642	1702	1737	1872	1912	2078	2250
STW1260 L or R	980	1035	1137	1214	1313	1363	1387	1494	1524	1662	1798
STW1560 L or R	1043	1097	1214	1292	1398	1450	1480	1592	1624	1769	1914
STW1860 L or R	1114	1170	1294	1378	1490	1545	1577	1698	1732	1885	2040
STW2160 L or R	1208	1268	1398	1493	1614	1675	1704	1835	1874	2039	2209
STW2460 L or R	1273	1337	1470	1572	1700	1764	1799	1939	1979	2153	2329

Custom Modifications

ADDTK	AUTH	CBO	CCO	CFNT0	CFRMO	CND	FB	FPEB	ID	MIP	P	RD
	•	•	•	•	•		•	•	•	•	•	•

Construction Upgrades

APW	PLE
•	•

Door Options

CG	CG.BTM	CG.TOP	MD	MD.BTM	MD.TOP	MFO
•	•			• ¹	• ¹	•

Non Soft-close Options

NSCH
•

¹ Not available on 12" wide

STACKED WALL CABINETS DOUBLE DOOR, 48", 51", 54", 57", or 60" HIGH

24", 27", 30", 33", or 36"

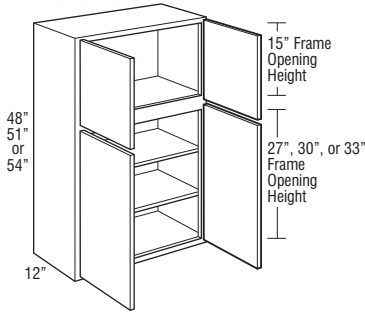

39" or 42"

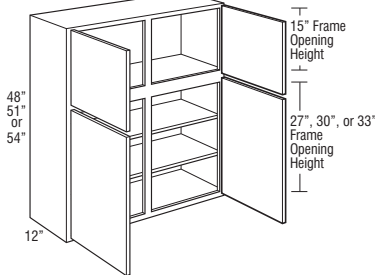

24", 27", 30", 33", or 36"

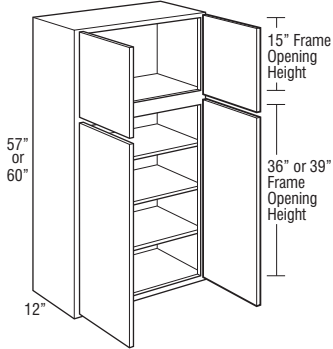

39" or 42"

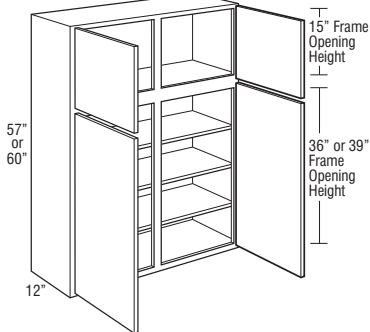

Price Point

	1	2	3	4	5	6	7	8	9	10	11
STW2448	1208	1272	1398	1494	1615	1674	1708	1838	1875	2044	2213
STW2748	1247	1307	1440	1538	1663	1724	1755	1895	1934	2105	2283
STW3048	1307	1378	1512	1614	1745	1810	1844	1989	2030	2212	2389
STW3348	1367	1434	1583	1684	1822	1889	1924	2079	2120	2302	2497
STW3648	1434	1507	1658	1770	1912	1982	2022	2182	2225	2424	2624
STW2451	1294	1363	1495	1600	1732	1795	1828	1968	2008	2189	2369
STW2751	1338	1405	1547	1649	1784	1852	1888	2034	2075	2262	2447
STW3051	1400	1477	1622	1732	1872	1940	1977	2132	2175	2372	2563
STW3351	1467	1539	1697	1805	1954	2028	2065	2229	2274	2473	2679
STW3651	1540	1619	1780	1902	2054	2129	2173	2345	2394	2604	2817
STW2454	1315	1383	1520	1624	1758	1823	1859	2000	2043	2225	2410
STW2754	1362	1432	1572	1679	1817	1883	1920	2068	2109	2299	2488
STW3054	1425	1500	1649	1763	1903	1973	2010	2168	2212	2413	2607
STW3354	1490	1564	1724	1837	1987	2062	2102	2267	2313	2514	2725
STW3654	1567	1647	1810	1934	2089	2167	2212	2387	2434	2649	2867
STW3948	1509	1585	1743	1862	2012	2088	2129	2294	2340	2550	2762
STW4248	1584	1665	1833	1955	2115	2194	2237	2412	2460	2679	2898
STW3951	1645	1729	1900	2032	2197	2279	2323	2504	2554	2784	3012
STW4251	1729	1817	2002	2132	2307	2393	2440	2629	2683	2923	3163
STW3954	1680	1765	1942	2073	2243	2327	2373	2555	2608	2843	3074
STW4254	1765	1857	2042	2178	2353	2440	2492	2684	2739	2985	3232
STW2457	1368	1439	1584	1689	1829	1898	1933	2082	2125	2315	2508
STW2757	1417	1488	1639	1749	1892	1962	1999	2155	2199	2399	2594
STW3057	1484	1563	1718	1835	1983	2055	2095	2263	2310	2514	2717
STW3357	1552	1628	1797	1914	2069	2147	2188	2360	2408	2622	2840
STW3657	1633	1717	1888	2017	2178	2258	2302	2484	2535	2762	2987
STW2460	1422	1495	1645	1757	1900	1972	2010	2164	2209	2405	2603
STW2760	1473	1547	1702	1820	1969	2042	2079	2239	2284	2489	2698
STW3060	1543	1624	1789	1910	2063	2139	2178	2352	2399	2613	2827
STW3360	1615	1692	1867	1987	2150	2232	2278	2457	2505	2727	2955
STW3660	1695	1787	1958	2098	2264	2347	2394	2583	2635	2869	3107
STW3957	1744	1833	2017	2157	2329	2417	2462	2655	2709	2953	3194
STW4257	1834	1927	2122	2263	2447	2538	2588	2789	2847	3102	3354
STW3960	1810	1903	2092	2235	2413	2503	2554	2754	2810	3060	3313
STW4260	1903	2000	2197	2348	2537	2630	2683	2892	2950	3212	3480

Custom Modifications

ADDTK	AUTH	CBO	CCO	CFNTO	CFRMO	CND	FB	FPEB	ID	MIP	P	RD
	•	•	•	•	•	•	•	•	•	•	• ¹	•

Construction Upgrades

APW	PLE
•	•

Door Options

CG	CG.BTM	CG.TOP	MD	MD.BTM	MD.TOP	MFO
•	•	•	• ²	• ²	•	•

Non Soft-close Options

NSCH
•

¹ Not available on 39" or 42" wide

² Not available on 39" wide

WALL THREE DRAWER SINGLE DOOR, 48", 51", 54", 57", or 60" HIGH

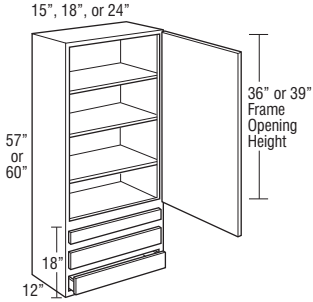
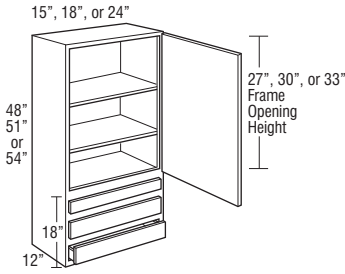

	Price Point	1	2	3	4	5	6	7	8	9	10	11
W3D1548 L or R		1053	1092	1175	1266	1327	1357	1426	1500	1508	1589	1667
W3D1848 L or R		1119	1171	1253	1346	1413	1445	1490	1570	1577	1665	1748
W3D2448 L or R		1296	1352	1449	1496	1584	1628	1659	1748	1761	1862	1959
W3D1551 L or R		1110	1154	1240	1334	1398	1430	1525	1603	1613	1704	1791
W3D1851 L or R		1179	1234	1329	1440	1498	1526	1595	1682	1693	1790	1875
W3D2451 L or R		1377	1441	1548	1601	1700	1748	1781	1883	1899	2009	2116
W3D1554 L or R		1168	1217	1308	1398	1468	1501	1549	1630	1640	1732	1829
W3D1854 L or R		1241	1299	1404	1463	1548	1590	1621	1710	1722	1820	1910
W3D2454 L or R		1453	1511	1603	1629	1730	1779	1812	1918	1934	2044	2156
W3D1557 L or R		1269	1321	1420	1448	1536	1580	1608	1695	1706	1804	1902
W3D1857 L or R		1349	1413	1500	1517	1607	1651	1684	1776	1790	1894	1990
W3D2457 L or R		1545	1567	1664	1696	1801	1854	1890	1999	2018	2136	2256
W3D1560 L or R		1284	1341	1460	1502	1592	1637	1668	1759	1773	1874	1968
W3D1860 L or R		1360	1425	1551	1572	1668	1716	1748	1845	1862	1967	2072
W3D2460 L or R		1599	1623	1728	1761	1874	1930	1967	2080	2100	2226	2357

- Includes one shallow depth drawer and two standard drawers.
- Top drawer front will be slab for all styles. Slab drawer fronts on certain styles will be painted hardwood. See Door Style section for exceptions.
- Drawer front to face frame reveal is justified to the top to be consistent with both full and partial overlay. Bottom reveal is 7/8" for full overlay and 1" for partial overlay.

Custom Modifications

ADDTK	AUTH	CBO	CCO	CFNTO	CFRMO	CND	FB	FPEB	ID	MIP	P	RD
	•	•	•		•	•	•	•	•	•		

Construction Upgrades

APW	PLE
•	•

Door Options

CG	CG.BTM	CG.TOP	MD	MD.BTM	MD.TOP	MFO
•			•			•

Non Soft-close Options

NSCH
•

WALL THREE DRAWER DOUBLE DOOR, 48", 51", 54", 57", or 60" HIGH

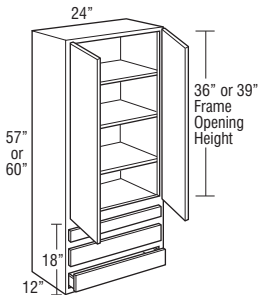
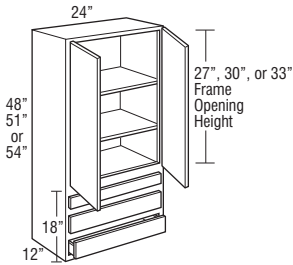

W3D2448	1364	1423	1527	1593	1688	1735	1769	1870	1884	1993	2100
W3D2451	1449	1515	1629	1724	1832	1884	1920	2032	2050	2171	2296
W3D2454	1538	1619	1723	1757	1866	1921	1957	2072	2092	2217	2345

W3D2457	1648	1688	1800	1840	1956	2014	2051	2174	2196	2330	2466
W3D2460	1694	1758	1876	1921	2044	2106	2148	2275	2299	2440	2585

- Includes one shallow depth drawer and two standard drawers
- Top drawer front will be slab for all styles. Slab drawer fronts on certain styles will be painted hardwood. See Door Style section for exceptions.
- Drawer front to face frame reveal is justified to the top to be consistent with both full and partial overlay. Bottom reveal is 7/8" for full overlay and 1" for partial overlay.

Custom Modifications

ADDTK	AUTH	CBO	CCO	CFNTO	CFRMO	CND	FB	FPEB	ID	MIP	P	RD
	•	•	•		•	•	•	•	•	•		

Construction Upgrades

APW	PLE
•	•

Door Options

CG	CG.BTM	CG.TOP	MD	MD.BTM	MD.TOP	MFO
•			•			•

Non Soft-close Options

NSCH
•

Wall Corner Cabinets

- Wall corner cabinets may be installed flush to the wall (left) or pulled 3" away from wall (right) to accommodate odd dimensions in a kitchen design. In either case, the adjoining run of 12" wall cabinets plus a 3" filler will butt against the solid-wood panel.
- When a cabinet is "pulled" it will use proportionally more wall space, for example, a 30" wide WC pulled 2" will use 32" of space.
- The L or R in the cabinet's nomenclature indicates the location of cabinet void.
- Blind side of wall corner cabinets cannot be installed next to a range hood or microwave shelf unit due to door interference.

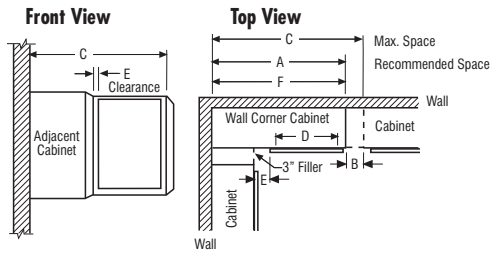

NOTE: All outside stiles are 1 1/2" wide

Model	A Recommended Space	B Max. Pull*	C Max. Space	D Face Frame Opening	E* Full Overlay At Min. At Max.		E Partial Overlay At Min. At Max.		F Actual Cabinet
WC24..	24"	5"	29"	7 1/2"	1 3/4"	6 3/4"	2 1/2"	7 1/2"	24"
WC27..	27"	4 1/2"	31 1/2"	9"	3 1/4"	7 3/4"	4"	8 1/2"	27"
WC30..	30"	5"	35"	13 1/2"	1 3/4"	6 3/4"	2 1/2"	7 1/2"	30"
WC33..	33"	4 1/2"	37 1/2"	15"	3 1/4"	7 3/4"	4"	8 1/2"	33"
WC36..	36"	5"	41"	19 1/2"	1 3/4"	6 3/4"	2 1/2"	7 1/2"	36"
WC42..	42"	4 1/2"	46 1/2"	24"	3 1/4"	7 3/4"	4"	8 1/2"	42"
WC48..	48"	4 1/2"	52 1/2"	30"	3 1/4"	7 3/4"	4"	8 1/2"	48"

*Minimum/maximum space between inside edge of door and face of filler/adjoining cabinet.
If cabinet is pulled to maximum stated dimension, filler will need to be cleated for proper attachment.

WALL CORNER SINGLE DOOR, 30" HIGH

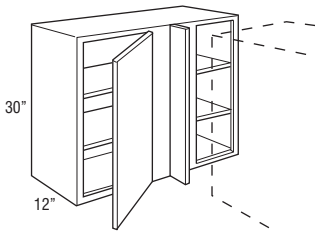

	Price Point	1	2	3	4	5	6	7	8	9	10	11
WC2430 L or R	471	497	545	582	629	652	665	707	733	797	843	
WC2730 L or R	500	524	582	620	670	695	706	761	777	847	916	
WC3030 L or R	537	565	620	662	716	743	758	817	834	908	982	
WC3330 L or R	576	606	667	713	771	799	815	876	894	976	1042	
WC3630 L or R	622	656	721	770	833	863	877	918	965	1052	1095	

- Includes one 3" filler, shipped unattached.
- L or R indicates void. R (right) void shown.

Custom Modifications

ADDTK	AUTH	CBO	CCO	CFNTO	CFRMO	CND	FB	FPEB	ID	MIP	P	RD
•	•	•	•	•	•	•	•	•	•	•	•	•

Construction Upgrades

APW	PLE
•	•

Door Options

CG	CG.BTM	CG.TOP	MD	MD.BTM	MD.TOP	MFO
•	•	•	•	•	•	•

Non Soft-close Options

NSCH
•

WALL CORNER DOUBLE DOOR, 30" HIGH

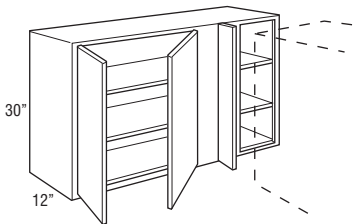

WC4230 L or R	732	768	848	903	976	1012	1034	1113	1135	1238	1338
WC4830 L or R	846	905	997	1064	1132	1164	1202	1239	1316	1421	1473

- Includes one 3" filler, shipped unattached.
- L or R indicates void. R (right) void shown.

Custom Modifications

ADDTK	AUTH	CBO	CCO	CFNTO	CFRMO	CND	FB	FPEB	ID	MIP	P	RD
•	•	•	•	•	•	•	•	•	•	•	•	•

Construction Upgrades

APW	PLE
•	•

Door Options

CG	CG.BTM	CG.TOP	MD	MD.BTM	MD.TOP	MFO
•	•	•	•	•	•	•

Non Soft-close Options

NSCH
•

WALL CORNER SINGLE DOOR, 33" HIGH

24", 27", 30", 33", or 36"

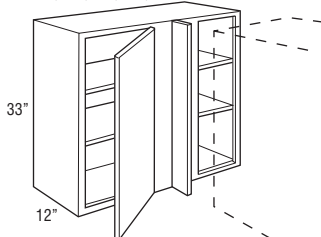

WC2433 L or R	528	554	612	652	704	730	745	793	819	892	946
WC2733 L or R	562	590	649	694	750	777	791	854	872	950	1026
WC3033 L or R	601	632	695	742	804	834	848	914	933	1017	1100
WC3333 L or R	648	681	749	801	866	898	913	987	1007	1097	1171
WC3633 L or R	695	733	805	861	930	964	983	1031	1081	1176	1227

- Includes one 3" filler, shipped unattached.
- L or R indicates void. R (right) void shown.

Custom Modifications

ADDTK	AUTH	CBO	CCO	CFNTO	CFRMO	CND	FB	FPEB	ID	MIP	P	RD
•	•	•	•	•	•	•	•	•	•	•	•	•

Construction Upgrades

APW	PLE
•	•

Door Options

CG	CG.BTM	CG.TOP	MD	MD.BTM	MD.TOP	MFO
•	•	•	•	•	•	•

Non Soft-close Options

NSCH
•

WALL CORNER SINGLE DOOR, 36" HIGH

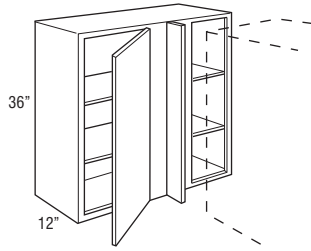

	Price Point	1	2	3	4	5	6	7	8	9	10	11
WC2436 L or R		541	568	629	668	724	752	765	824	840	916	992
WC2736 L or R		576	604	666	712	769	797	814	876	894	976	1054
WC3036 L or R		618	648	713	763	825	855	871	939	958	1044	1131
WC3336 L or R		666	700	769	823	890	923	939	1015	1036	1128	1220
WC3636 L or R		713	751	826	884	956	991	1010	1088	1110	1208	1308

- Includes one 3" filler, shipped unattached.
- L or R indicates void. R (right) void shown.

Custom Modifications

ADDTK	AUTH	CBO	CCO	CFNTO	CFRMO	CND	FB	FPEB	ID	MIP	P	RD
•	•	•	•	•	•		•	•	•	•		•

Construction Upgrades

APW	PLE
•	•

Door Options

CG	CG.BTM	CG.TOP	MD	MD.BTM	MD.TOP	MFO
						•

Non Soft-close Options

NSCH
•

WALL CORNER SINGLE DOOR, 39" or 42" HIGH

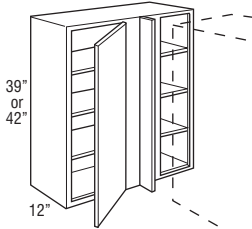

WC2439 L or R	577	606	668	713	771	800	816	877	895	978	1058
WC2739 L or R	613	644	708	759	819	849	867	935	954	1041	1126
WC3039 L or R	658	692	761	812	879	911	929	1001	1021	1112	1203
WC3339 L or R	708	745	821	877	949	984	1002	1081	1104	1200	1299
WC3639 L or R	761	800	880	941	1016	1053	1075	1161	1184	1287	1394
WC2442 L or R	611	641	707	755	818	849	866	933	952	1040	1122
WC2742 L or R	650	684	753	804	868	901	918	989	1010	1101	1193
WC3042 L or R	696	733	808	862	931	966	985	1061	1082	1178	1280
WC3342 L or R	752	791	872	929	1005	1043	1062	1145	1169	1275	1378
WC3642 L or R	807	849	935	998	1080	1120	1140	1229	1254	1368	1480

- Includes one 3" filler, shipped unattached.
- L or R indicates void. R (right) void shown.

Custom Modifications

ADDTK	AUTH	CBO	CCO	CFNTO	CFRMO	CND	FB	FPEB	ID	MIP	P	RD
•	•	•	•	•	•		•	•	•	•		•

Construction Upgrades

APW	PLE
•	•

Door Options

CG	CG.BTM	CG.TOP	MD	MD.BTM	MD.TOP	MFO
						•

Non Soft-close Options

NSCH
•

DIAGONAL WALL, 12", 15", or 18" HIGH, 24" x 24"

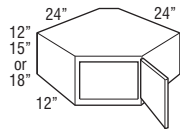

DW122424 L or R	326	356	412	427	437	443	457	472	502	543	558
DW152424 L or R	362	395	459	475	485	491	508	524	556	603	622
DW182424 L or R	403	438	510	528	540	546	563	581	616	668	690

- Cabinets require 24" x 24" of corner wall space.
- Full overlay styles use the same width doors as partial overlay styles (14 1/2" wide) with a partial overlay hinge (38NPOHINGE) to allow for proper door clearance with adjacent cabinets.

Custom Modifications

ADDTK	AUTH	CBO	CCO	CFNTO	CFRMO	CND	FB	FPEB	ID	MIP	P	RD
•	•	•	•	•	•		•	•	•	•		•

Construction Upgrades

APW	PLE
•	•

Door Options

CG	CG.BTM	CG.TOP	MD	MD.BTM	MD.TOP	MFO
			• ¹			•

Non Soft-close Options

NSCH
•

¹ Not available on DW122424 L or R

DIAGONAL WALL, 24" or 27" HIGH, 24" x 24"

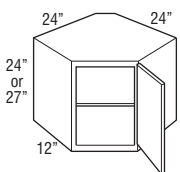

DW242424 L or R	448	488	565	586	600	606	627	647	687	743	769
DW272424 L or R	498	541	630	652	667	674	696	718	764	826	854

- Cabinets require 24" x 24" of corner wall space.
- Adjustable shelf cannot be removed/retrofitted.
- Full overlay styles use the same width doors as partial overlay styles (14 1/2" wide) with a partial overlay hinge (38NPOHINGE) to allow for proper door clearance with adjacent cabinets.

Custom Modifications

ADDTK	AUTH	CBO	CCO	CFNTO	CFRMO	CND	FB	FPEB	ID	MIP	P	RD
•	•	•	•	•	•		•	•	•	•		•

Construction Upgrades

APW	PLE
•	•

Door Options

CG	CG.BTM	CG.TOP	MD	MD.BTM	MD.TOP	MFO
			• ¹			•

Non Soft-close Options

NSCH
•

¹ Not available on DW272424 L or R

DIAGONAL WALL, 30", 33", 36", 39", or 42" HIGH, 24" x 24"

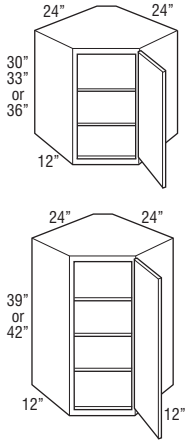

	Price Point	1	2	3	4	5	6	7	8	9	10	11
DW302424 L or R		552	601	698	724	741	749	773	797	847	917	949
DW332424 L or R		624	669	783	814	833	843	872	900	956	1032	1069
DW362424 L or R		695	739	871	903	924	936	969	1001	1061	1146	1189

DW392424 L or R	765	812	946	995	1019	1030	1066	1101	1169	1263	1309
DW422424 L or R	845	896	1002	1072	1105	1122	1163	1203	1276	1380	1432

- Cabinets require 24" x 24" of corner wall space.
- Full overlay styles use the same width doors as partial overlay styles (14 1/2" wide) with a partial overlay hinge (38NPOHINGE) to allow for proper door clearance with adjacent cabinets.

Custom Modifications

ADDTK	AUTH	CBO	CCO	CFNTO	CFRMO	CND	FB	FPEB	ID	MIP	P	RD
	•	•	•	•	•	•	•	•	•	•		

Construction Upgrades

APW	PLE
•	•

Door Options

CG	CG.BTM	CG.TOP	MD	MD.BTM	MD.TOP	MFO
•			•			•

Non Soft-close Options

NSCH
•

DIAGONAL WALL, 30", 33", 36", 39", or 42" HIGH, 27" x 27"

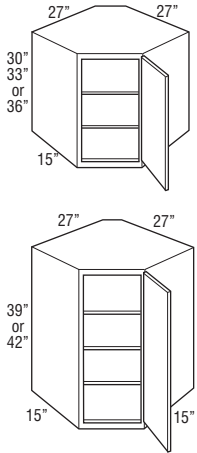

DW302727 L or R	726	764	839	898	969	1005	1023	1105	1127	1227	1330
DW332727 L or R	814	855	940	1005	1086	1126	1146	1237	1263	1375	1489
DW362727 L or R	835	877	965	1033	1116	1156	1176	1268	1294	1413	1529

DW392727 L or R	890	936	1029	1100	1188	1231	1257	1353	1381	1506	1630
DW422727 L or R	944	992	1091	1165	1262	1309	1332	1439	1468	1598	1729

- Cabinets require 27" x 27" of corner wall space.
- Full overlay styles use the same width doors as partial overlay styles (14 1/2" wide) with a partial overlay hinge (38NPOHINGE) to allow for proper door clearance with adjacent cabinets.

Custom Modifications

ADDTK	AUTH	CBO	CCO	CFNTO	CFRMO	CND	FB	FPEB	ID	MIP	P	RD
	•	•	•	•	•	•	•	•	•	•		

Construction Upgrades

APW	PLE
•	•

Door Options

CG	CG.BTM	CG.TOP	MD	MD.BTM	MD.TOP	MFO
•			•			•

Non Soft-close Options

NSCH
•

STACKED DIAGONAL WALL, 48", 51", 54", 57", or 60" HIGH, 24" x 24"

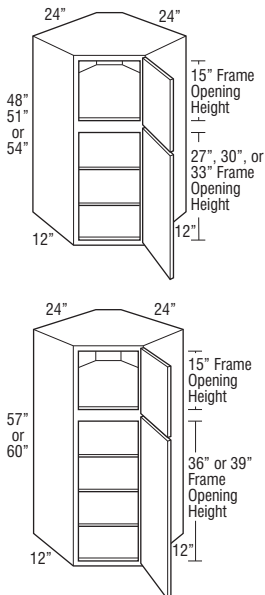

STDW482424 L or R	1194	1299	1510	1565	1602	1619	1670	1723	1829	1982	2049
STDW512424 L or R	1284	1384	1617	1678	1717	1737	1794	1852	1965	2125	2199
STDW542424 L or R	1373	1472	1727	1789	1830	1853	1915	1978	2097	2268	2349

STDW572424 L or R	1460	1563	1820	1904	1949	1970	2037	2103	2232	2414	2499
STDW602424 L or R	1560	1668	1890	2000	2057	2085	2158	2230	2365	2560	2653

- Cabinet requires 24" x 24" of corner wall space.
- Full overlay styles use the same width doors as partial overlay styles (14 1/2" wide) with a partial overlay hinge (38NPOHINGE) to allow for proper door clearance with adjacent cabinets.

Custom Modifications

ADDTK	AUTH	CBO	CCO	CFNTO	CFRMO	CND	FB	FPEB	ID	MIP	P	RD
	•	•	•	•	•	•	•	•	•	•		

Construction Upgrades

APW	PLE
•	•

Door Options

CG	CG.BTM	CG.TOP	MD	MD.BTM	MD.TOP	MFO
•	•	•	•	•	•	•

Non Soft-close Options

NSCH
•

**STACKED DIAGONAL WALL,
48", 51", 54", 57", or 60" HIGH,
27" x 27"**

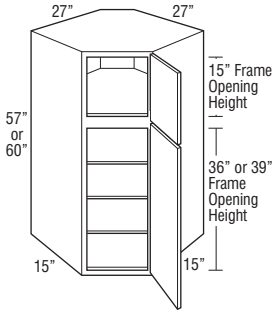
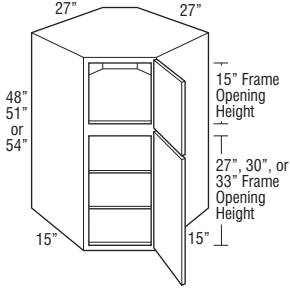

Price Point	1	2	3	4	5	6	7	8	9	10	11
STDW482727 L or R	1722	1819	2005	2155	2333	2422	2468	2672	2727	2980	3235
STDW512727 L or R	1831	1932	2132	2290	2479	2573	2621	2837	2896	3164	3433
STDW542727 L or R	1857	1960	2162	2324	2517	2610	2659	2877	2935	3213	3484

STDW572727 L or R	1926	2033	2243	2408	2607	2704	2760	2983	3045	3329	3610
STDW602727 L or R	1993	2104	2321	2490	2699	2800	2854	3089	3152	3443	3733

- Cabinet requires 27" x 27" of corner wall space.
- Full overlay styles use the same width doors as partial overlay styles (14 1/2" wide) with a partial overlay hinge (38NPOHINGE) to allow for proper door clearance with adjacent cabinets.

Custom Modifications

ADDTK	AUTH	CBO	CCO	CFNTO	CFRMO	CND	FB	FPEB	ID	MIP	P	RD
	•	•	•	•	•		•	•		•		

Construction Upgrades

APW	PLE
•	•

Door Options

CG	CG.BTM	CG.TOP	MD	MD.BTM	MD.TOP	MFO
•		•		•	•	•

Non Soft-close Options

NSCH
•

**DIAGONAL WALL with LAZY SUSAN,
30", 33", 36", 39", or 42" HIGH,
24" x 24"**

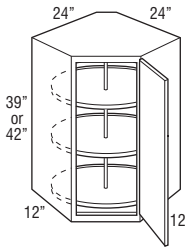
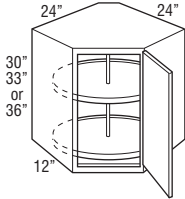

DW302424S L or R	811	865	986	1028	1054	1068	1109	1148	1219	1318	1366
DW332424S L or R	910	956	1104	1148	1179	1193	1238	1283	1361	1471	1526
DW362424S L or R	1007	1044	1220	1271	1303	1320	1368	1417	1504	1623	1684

DW392424S L or R	1109	1147	1340	1396	1433	1451	1506	1561	1651	1785	1854
DW422424S L or R	1202	1224	1452	1512	1552	1571	1630	1689	1791	1936	2005

- Cabinets require 24" x 24" of corner wall space.
- Plywood shelves are 18" in overall diameter with a 17" interior diameter and a 1" high lip.
- Full overlay styles use the same width doors as partial overlay styles (14 1/2" wide) with a partial overlay hinge (38NPOHINGE) to allow for proper door clearance with adjacent cabinets.
- Shelves rotate independently.

Custom Modifications

ADDTK	AUTH	CBO	CCO	CFNTO	CFRMO	CND	FB	FPEB	ID	MIP	P	RD
	•	•	•	•	•		•	•		•		

Construction Upgrades

APW	PLE
•	•

Door Options

CG	CG.BTM	CG.TOP	MD	MD.BTM	MD.TOP	MFO
•			•			•

Non Soft-close Options

NSCH
•

EASY REACH WALL CORNER, 30", 33", 36", 39", or 42" HIGH, 24" x 24"

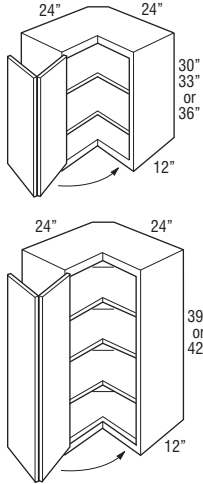

Price Point

	1	2	3	4	5	6	7	8	9	10	11
ER30 L or R	795	834	918	979	1025	1048	1086	1122	1188	1286	1331
ER33 L or R	889	936	1029	1098	1142	1164	1207	1247	1322	1427	1481
ER36 L or R	911	960	1056	1126	1219	1265	1288	1370	1418	1544	1628
ER39 L or R	972	1024	1124	1200	1299	1348	1374	1481	1511	1645	1779
ER42 L or R	1031	1085	1197	1274	1379	1431	1458	1571	1603	1748	1890

- Hinged door opens 170°.
- Requires 24" x 24" of corner wall space.
- Decorative hardware screws must be countersunk to prevent scratching of adjacent cabinets and face frame of ER.
- Integrated soft-close hinge not included.

Custom Modifications

ADDTK	AUTH	CBO	CCO	CFNTO	CFRMO	CND	FB	FPEB	ID	MIP	P	RD
	•	•	•				•	•		•		

Construction Upgrades

APW	PLE
•	•

Door Options

CG	CG.BTM	CG.TOP	MD	MD.BTM	MD.TOP	MFO
						•

Non Soft-close Options

NSCH
STD

ASYMMETRICAL EASY REACH WALL CORNER, 30", 33", 36", 39", or 42" HIGH

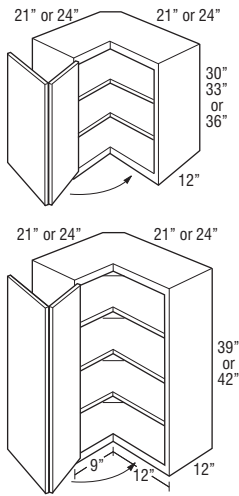

ER302124 L or R	795	834	918	979	1025	1048	1086	1122	1188	1286	1331
ER302421 L or R	795	834	918	979	1025	1048	1086	1122	1188	1286	1331
ER332124 L or R	889	936	1029	1098	1142	1164	1207	1247	1322	1427	1481
ER332421 L or R	889	936	1029	1098	1142	1164	1207	1247	1322	1427	1481
ER362124 L or R	911	960	1056	1126	1219	1265	1288	1370	1418	1544	1628
ER362421 L or R	911	960	1056	1126	1219	1265	1288	1370	1418	1544	1628

ER392124 L or R	972	1024	1124	1200	1299	1348	1374	1481	1511	1645	1779
ER392421 L or R	972	1024	1124	1200	1299	1348	1374	1481	1511	1645	1779
ER422124 L or R	1031	1085	1197	1274	1379	1431	1458	1571	1603	1748	1890
ER422421 L or R	1031	1085	1197	1274	1379	1431	1458	1571	1603	1748	1890

- Hinged door opens to 170°.
- Adjustable shelves.
- Legs at the front frames are 9" on 21" leg and 12" on 24" leg.
- Nomenclature for asymmetrical cabinets reads as follows:
 First set of numbers = height
 Second set of numbers = left side
 Third set of numbers = right side
- Decorative hardware screws must be countersunk to prevent scratching of adjacent cabinets and face frame of ER.
- ER__2124L shown.
- Integrated soft-close hinge not included.

Custom Modifications

ADDTK	AUTH	CBO	CCO	CFNTO	CFRMO	CND	FB	FPEB	ID	MIP	P	RD
	•	•	•				•	•		•		

Construction Upgrades

APW	PLE
•	•

Door Options

CG	CG.BTM	CG.TOP	MD	MD.BTM	MD.TOP	MFO
						•

Non Soft-close Options

NSCH
STD

WALL END CABINET SINGLE DOOR, 30", 33", 36", 39", or 42" HIGH, 12" x 12"

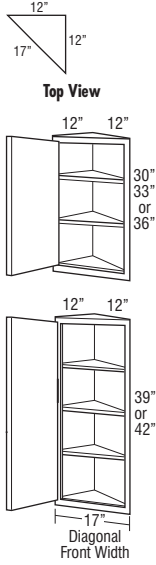

	Price Point	1	2	3	4	5	6	7	8	9	10	11
WEC1230 L or R		429	475	554	574	587	594	615	636	671	727	752
WEC1233 L or R		504	544	620	643	658	666	688	711	756	818	845
WEC1236 L or R		543	585	689	715	732	740	765	789	838	908	936

WEC1239 L or R	599	646	759	786	804	812	840	867	919	997	1031
WEC1242 L or R	631	680	782	824	852	865	905	946	1000	1080	1120

- Width at wall: 12" x 12".
- Cabinet features two unfinished back panels. Must be installed with one back panel adjacent to a cabinet of equal height with the other back panel attached to the wall.
- When ordered with MD, shelves will not align with mullions.

Custom Modifications

ADDTK	AUTH	CBO	CCO	CFNTO	CFRMO	CND	FB	FPEB	ID	MIP	P	RD
		•	•	•	•					•		

Construction Upgrades

APW	PLE
•	

Door Options

CG	CG.BTM	CG.TOP	MD	MD.BTM	MD.TOP	MFO
•			•			•

Non Soft-close Options

NSCH
•

WALL QUARTER ROUND END SHELF, 30", 33", 36", 39", or 42" HIGH

Square Top and Bottom Panels

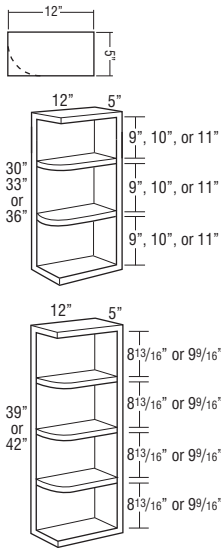

WQRES630STSB	342	342	342	342	342	342	342	342	342	342	342
WQRES633STSB	385	385	385	385	385	385	385	385	385	385	385
WQRES636STSB	396	396	396	396	396	396	396	396	396	396	396

WQRES639STSB	429	429	429	429	429	429	429	429	429	429	429
WQRES642STSB	462	462	462	462	462	462	462	462	462	462	462

- Units are reversible.
- Veneer on 3/4" furniture board core with matching interior.
- Cabinet features two unfinished back panels. Must be installed with one back panel adjacent to a cabinet of equal height with the other back panel attached to the wall.

MODIFICATIONS

No modifications available for these products.

Construction Upgrades

APW	PLE
•	

WALL MICROWAVE CABINET, 18" HIGH

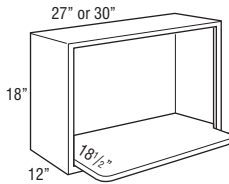

	Opening		Cabinet	
	Width	Height	Width	Height
MW2718	24"	14 1/4"	27"	18"
MW3018	27"	14 1/4"	30"	18"

MW2718	560	560	560	560	560	560	560	560	560	560
MW3018	591	591	591	591	591	591	591	591	591	591

- Includes one 3/4" shelf with six mounting screws. Shelf is veneer plywood. Microwave shelf extends beyond the front of the cabinet by 6 1/2", for a total shelf depth of 18 1/2".
- Microwave cabinet must be attached to wall stud and adjacent cabinets on both sides for support.
- When ID is ordered, shelf will not be included with cabinet.
- When placed at a different height than adjacent cabinets, FPEB modification is recommended.

Custom Modifications

ADDTK	AUTH	CBO	CCO	CFNTO	CFRMO	CND	FB	FPEB	ID	MIP	P	RD
		•	STD		•			•	•	STD		

Construction Upgrades

APW	PLE

Door Options

CG	CG.BTM	CG.TOP	MD	MD.BTM	MD.TOP	MFO

Non Soft-close Options

NSCH

WALL MICROWAVE DOUBLE DOOR CABINET, 36", 39", or 42" HIGH

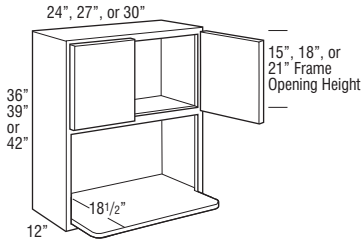

	Opening		Cabinet	
	Width	Height	Width	Height
WMW2436	21"	15 3/4"	24"	36"
WMW2736	24"	15 3/4"	27"	36"
WMW3036	27"	15 3/4"	30"	36"
WMW2439	21"	15 3/4"	24"	39"
WMW2739	24"	15 3/4"	27"	39"
WMW3039	27"	15 3/4"	30"	39"
WMW2442	21"	15 3/4"	24"	42"
WMW2742	24"	15 3/4"	27"	42"
WMW3042	27"	15 3/4"	30"	42"

Price Point	1	2	3	4	5	6	7	8	9	10	11
WMW2436	1369	1379	1420	1428	1469	1489	1499	1534	1543	1584	1622
WMW2736	1455	1509	1554	1563	1608	1630	1641	1680	1691	1734	1777
WMW3036	1570	1693	1864	1912	1967	1994	2008	2053	2066	2121	2173
WMW2439	1446	1509	1554	1563	1608	1630	1641	1680	1691	1734	1777
WMW2739	1539	1639	1689	1701	1749	1772	1785	1826	1837	1885	1930
WMW3039	1596	1722	1900	1956	1993	2011	2067	2122	2209	2268	2322
WMW2442	1575	1639	1689	1701	1749	1772	1785	1826	1837	1885	1930
WMW2742	1659	1771	1825	1836	1887	1912	1926	1971	1983	2036	2085
WMW3042	1701	1834	2024	2085	2124	2143	2202	2261	2351	2415	2472

- Includes one 3/4" shelf with six mounting screws. Shelf is veneer on furniture board core. Microwave shelf extends beyond the front of the cabinet by 6 1/2", for a total shelf depth of 18 1/2".
- 42" high cabinets include one adjustable shelf in the upper section.
- Microwave cabinet must be attached to wall stud and adjacent cabinets on both sides to support.
- When ID is ordered, shelf will not be included with cabinet.
- When placed at a different height than adjacent cabinets, FPFB modification is recommended.

Custom Modifications

ADDTK	AUTH	CBO	CCO	CFNTO	CFRMO	CND	FB	FPFB	ID	MIP	P	RD
	•	•	•	•	•			•	•			STD

Construction Upgrades

APW	PLE

Door Options

CG	CG.BTM	CG.TOP	MD	MD.BTM	MD.TOP	MFO
•						•

Non Soft-close Options

NSCH
•

WALL BUILT-IN MICROWAVE DOUBLE DOOR CABINET, 36", 39", or 42" HIGH, 21" DEEP

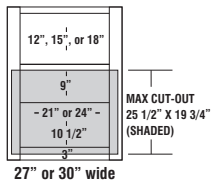
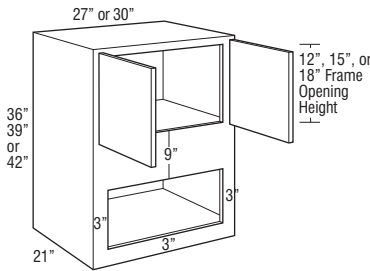

WBMW273621	833	866	937	983	1054	1089	1103	1174	1198	1286	1377
WBMW303621	865	899	972	1021	1095	1131	1144	1221	1246	1341	1437
WBMW273921	879	914	988	1039	1115	1153	1166	1245	1271	1365	1462
WBMW303921	913	948	1028	1080	1159	1197	1213	1294	1321	1420	1524
WBMW274221	923	961	1040	1097	1175	1215	1229	1313	1340	1440	1545
WBMW304221	959	996	1082	1140	1222	1263	1283	1368	1396	1501	1611

- Uses face mount hinges, doors and drawer fronts have a consistent width reveal for full overlay (1/4") and partial overlay (1").
- Microwave cabinet must be attached to wall stud and adjacent cabinets on both sides to support.
- When placed at a different height than adjacent cabinet, skins or FPFB option should be applied to taller cabinets in the run for correct reveal on each side.
- RD is available to 15".

Custom Modifications

ADDTK	AUTH	CBO	CCO	CFNTO	CFRMO	CND	FB	FPFB	ID	MIP	P	RD
	•		•		•		•	•	•	•		•

Construction Upgrades

APW	PLE
•	•

Door Options

CG	CG.BTM	CG.TOP	MD	MD.BTM	MD.TOP	MFO
						•

Non Soft-close Options

NSCH
•

Model	Factory Opening	Maximum Cut-out
2736	21W x 10 1/2H	25 1/2W x 19 3/4H
2739	21W x 10 1/2H	25 1/2W x 19 3/4H
2742	21W x 10 1/2H	25 1/2W x 19 3/4H
3036	24W x 10 1/2H	28 1/2W x 19 3/4H
3039	24W x 10 1/2H	28 1/2W x 19 3/4H
3042	24W x 10 1/2H	28 1/2W x 19 3/4H

WALL APPLIANCE GARAGE, 18" HIGH

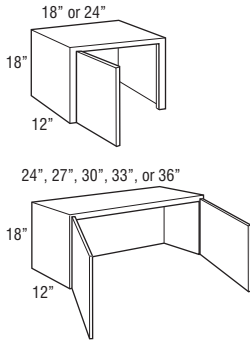

	Price Point	1	2	3	4	5	6	7	8	9	10	11
WAGD18 L or R		364	385	425	455	491	509	520	560	572	627	678
WAGD24 L or R		376	395	435	466	503	521	532	573	585	637	690
WAGD24		414	435	479	511	553	574	586	630	643	700	759
WAGD27		438	461	508	541	586	609	621	668	681	743	805
WAGD30		482	507	558	595	644	669	683	735	750	817	885
WAGD33		530	557	614	655	709	736	751	809	825	899	974
WAGD36		583	613	676	720	780	810	826	890	908	988	1071

- Cabinet does not have a bottom.
- Bottom edge is not trimmable.
- Standard cabinet interior, order MIP for matching interior.
- Cabinet is designed to fit beneath standard wall cabinets.

Custom Modifications

ADDTK	AUTH	CBO	CCO	CFNTO	CFRMO	CND	FB	FPEB	ID	MIP	P	RD
	•		•	•	•		•	•	•	•		

Construction Upgrades

APW	PLE
•	•

Door Options

CG	CG.BTM	CG.TOP	MD	MD.BTM	MD.TOP	MFO
						•

Non Soft-close Options

NSCH
•

CORNER DOOR, 18" HIGH

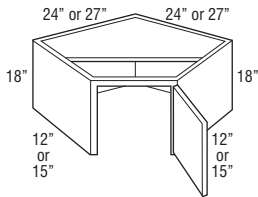

CD2424 L or R	534	563	618	660	714	741	755	812	829	868	874
CD2727 L or R	581	612	672	720	777	805	820	885	903	982	1064

- CD2424 L or R requires 24" x 24" corner wall space.
- CD2727 L or R requires 27" x 27" corner wall space.
- Cabinet is designed to fit beneath Diagonal Wall Cabinets.
- Cabinet has partial top and no bottom.
- Full overlay styles use the same width doors as partial overlay styles (14 1/2" wide) with a partial overlay hinge (38NPOHINGE) to allow for proper door clearance with adjacent cabinets.

Custom Modifications

ADDTK	AUTH	CBO	CCO	CFNTO	CFRMO	CND	FB	FPEB	ID	MIP	P	RD
	•		•	•	•		•	•	•	•		

Construction Upgrades

APW	PLE
•	•

Door Options

CG	CG.BTM	CG.TOP	MD	MD.BTM	MD.TOP	MFO
						•

Non Soft-close Options

NSCH
•

WALL BOX COLUMN PULL-OUT, PLAIN

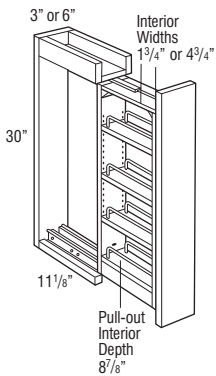

WBCPO330	772	772	772	772	772	772	772	772	772	772	772
WBCPO630	982	982	982	982	982	982	982	982	982	982	982

- Recommend installation between two cabinets. Can be installed on the end of a run or adjacent to an appliance with a 3/4" thick end panel.
- Install unit before removing shipping brace.
- All styles feature a natural finish full extension wood pull-out with adjustable shelves and chrome rail sides.
- In order to allow proper clearance for opening and closing, allow an additional 1/8" space between adjacent cabinet face frames. The 3" wide pull-outs require 3 1/8" space and the 6" wide pull-outs require 6 1/8" space. Spacers are included with the pull-outs to allow for proper installation.
- Not compatible with face mount moulding.
- For full access from both sides of unit, do not install against a wall or next to deeper appliances and cabinets.
- Soft-close guide not featured.

MODIFICATIONS

No modifications available for these products.

WALL BOX COLUMN PULL-OUT, OVERLAY

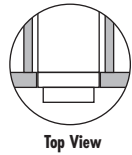
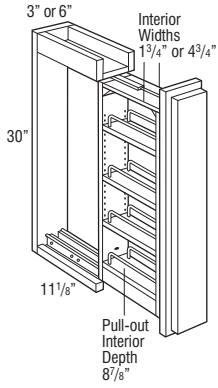

Price Point	1	2	3	4	5	6	7	8	9	10	11
WBCP03300L	827	827	827	827	827	827	827	827	827	827	827
WBCP06300L	1044	1044	1044	1044	1044	1044	1044	1044	1044	1044	1044

- Recommend installation between two cabinets. Can be installed on the end of a run or adjacent to an appliance with a 3/4" thick end panel.
- Install unit before removing shipping brace and attaching filler.
- Includes profiled full overlay filler, but unattached.
- Certain door style overlays will be painted hardwood. See Door Style section for exceptions.
- All styles feature a natural finish full extension wood pull-out with adjustable shelves and chrome rail sides.
- In order to allow proper clearance for opening and closing, allow an additional 1/8" space between adjacent cabinet face frames. The 3" wide pull-outs require 3 1/8" space and the 6" wide pull-outs require 6 1/8" space. Spacers are included with the pull-outs to allow for proper installation.
- Not compatible with face mount moulding.
- For full access from both sides of unit, do not install against a wall or next to deeper appliances and cabinets.
- Soft-close guide not featured.

MODIFICATIONS
No modifications available for these products.

WALL SPICE PULL-OUT, 30", 33", 36", 39", or 42" HIGH

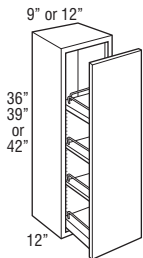
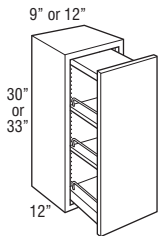

WSP930	871	888	927	952	988	1006	1015	1051	1062	1110	1158
WSP1230	926	945	982	1012	1049	1068	1077	1116	1128	1181	1233
WSP933	910	929	968	1000	1039	1058	1069	1111	1124	1174	1230
WSP1233	968	990	1030	1063	1105	1127	1138	1181	1195	1252	1309

WSP936	918	938	980	1014	1053	1072	1082	1127	1139	1191	1247
WSP1236	978	1000	1041	1075	1120	1142	1151	1197	1211	1270	1328
WSP939	942	966	1008	1042	1086	1107	1116	1163	1176	1232	1292
WSP1239	1004	1029	1074	1110	1155	1177	1188	1237	1252	1312	1376
WSP942	968	993	1037	1072	1117	1139	1151	1199	1213	1276	1336
WSP1242	1029	1056	1103	1141	1188	1212	1224	1277	1291	1355	1422

- 30" and 33" high units include a natural finish, full extension wood pull-out with two adjustable shelves, one fixed shelf, and chrome finish rail sides.
- Wood plugs for top of 30" and 33" high pull-out included for field installation.
- 36" to 42" high units include a natural finish, full extension wood pull-out with two adjustable shelves, two fixed shelves, and chrome finish rail sides.
- Wire for top rail on 36" to 42" high pull-out included separately for field installation.
- Shelf dimensions for 9" wide cabinets are 4 1/4" wide x 9 1/2" deep. Shelf dimensions for 12" wide cabinets are 7 1/4" wide x 9 1/2" deep.
- For full access from both sides of unit, do not install against a wall or next to deeper appliances and cabinets.

Custom Modifications												
ADDTK	AUTH	CBO	CCO	CFNTO	CFRMO	CND	FB	FPEB	ID	MIP	P	RD
•	•	•	•		•		•	•				

Construction Upgrades	
APW	PLE
•	•

Door Options						
CG	CG.BTM	CG.TOP	MD	MD.BTM	MD.TOP	MFO
						•

Non Soft-close Options
NSCH

WALL WINE RACK, 18" or 30" HIGH

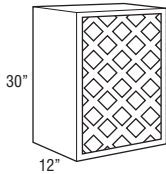
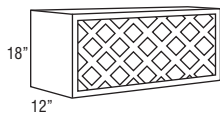

Model	# of Bottles
WNR3018	11
WNR3618	13
WNR1830	11

	Price Point	1	2	3	4	5	6	7	8	9	10	11
WNR3018		759	759	759	759	759	759	759	759	759	759	759
WNR3618		817	817	817	817	817	817	817	817	817	817	817

WNR1830	759	759	759	759	759	759	759	759	759	759	759	759
----------------	-----	-----	-----	-----	-----	-----	-----	-----	-----	-----	-----	-----

- Solid-wood lattice work.
- Wine bottle opening 4" x 4".

Custom Modifications

ADDTK	AUTH	CBO	CCO	CFNTO	CFRMO	CND	FB	FPEB	ID	MIP	P	RD
•					•				•	STD		

Construction Upgrades

APW	PLE

Door Options

CG	CG.BTM	CG.TOP	MD	MD.BTM	MD.TOP	MFO

Non Soft-close Options

NSCH

WINE STORAGE CABINET, 12", 15", 18", 21", or 24" HIGH

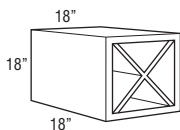
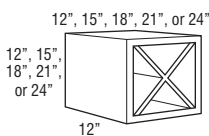

Model	# of Bottles*
WSC121212	4
WSC151512	10
WSC181812	18
WSC212112	24
WSC242412	32
WSC181818	18

*Standard 3 1/8" wine bottles.

WSC121212	652	652	652	652	652	652	652	652	652	652	652	652
WSC151512	687	687	687	687	687	687	687	687	687	687	687	687
WSC181812	723	723	723	723	723	723	723	723	723	723	723	723
WSC212112	759	759	759	759	759	759	759	759	759	759	759	759
WSC242412	797	797	797	797	797	797	797	797	797	797	797	797

WSC181818	784	784	784	784	784	784	784	784	784	784	784	784
------------------	-----	-----	-----	-----	-----	-----	-----	-----	-----	-----	-----	-----

- Must be installed between two cabinets, between a cabinet and a wall, or mounted to a horizontal surface.
- "X" shelf configuration cannot be removed.
- Reduced depth not recommended for safe wine bottle storage.

Custom Modifications

ADDTK	AUTH	CBO	CCO	CFNTO	CFRMO	CND	FB	FPEB	ID	MIP	P	RD
									•	STD		•

Construction Upgrades

APW	PLE

Door Options

CG	CG.BTM	CG.TOP	MD	MD.BTM	MD.TOP	MFO

Non Soft-close Options

NSCH

WALL CUBE HORIZONTAL, 30", 36", or 42" WIDE, 6" HIGH

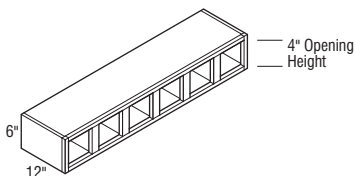

WCH30 (5 openings)	956	956	956	956	956	956	956	956	956	956	956	956
WCH36 (6 openings)	1048	1048	1048	1048	1048	1048	1048	1048	1048	1048	1048	1048
WCH42 (7 openings)	1155	1155	1155	1155	1155	1155	1155	1155	1155	1155	1155	1155

- Increased Depth only available in 3" increments.

Custom Modifications

ADDTK	AUTH	CBO	CCO	CFNTO	CFRMO	CND	FB	FPEB	ID	MIP	P	RD
					•				•	•	STD	

Construction Upgrades

APW	PLE
•	

Door Options

CG	CG.BTM	CG.TOP	MD	MD.BTM	MD.TOP	MFO

Non Soft-close Options

NSCH

WALL ORGANIZER, 30", 33", or 36" WIDE, 9" HIGH

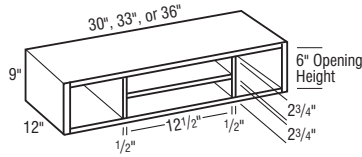

	Price Point	1	2	3	4	5	6	7	8	9	10	11
WORG30		956	956	956	956	956	956	956	956	956	956	956
WORG33		1002	1002	1002	1002	1002	1002	1002	1002	1002	1002	1002
WORG36		1048	1048	1048	1048	1048	1048	1048	1048	1048	1048	1048

Custom Modifications

ADDTK	AUTH	CBO	CCO	CFNTO	CFRMO	CND	FB	FPEB	ID	MIP	P	RD
						•			•	•		STD

Construction Upgrades

APW	PLE
•	

Door Options

CG	CG.BTM	CG.TOP	MD	MD.BTM	MD.TOP	MFO

Non Soft-close Options

NSCH

WALL MESSAGE CENTER, 30", 33", 36", 39", or 42" HIGH, 3" DEEP

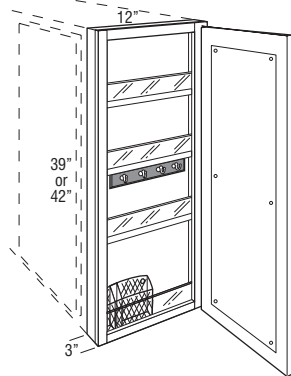
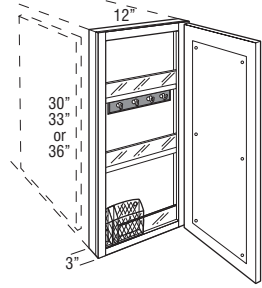

WMC1230 L or R	955	974	1011	1041	1078	1097	1106	1145	1157	1210	1262
WMC1233 L or R	997	1019	1059	1092	1134	1156	1167	1210	1224	1281	1338
WMC1236 L or R	1007	1029	1070	1104	1149	1171	1180	1226	1240	1299	1357

WMC1239 L or R	1033	1058	1103	1139	1184	1206	1217	1266	1281	1341	1405
WMC1242 L or R	1058	1085	1132	1170	1217	1241	1253	1306	1320	1384	1451

- Includes magnetic whiteboard on back of door, key hooks, pencil holder, and fixed plexi-glass fronted shelves.
- WMC1230, WMC1233, and WMC1236 have 2 fixed shelves. WMC1239 and WMC1242 have 3 fixed shelves.
- Not recommended for use next to a Peninsula cabinet due to the additional 1/4" cabinet depth.
- Door will open 90° without decorative hardware.
- Cabinet should be hinged on wall side.
- For proper installation, adjacent cabinet must have FPEB or 1/4" skin applied.
- Overlay fillers can be used on side of cabinet to add a decorative touch.

Custom Modifications

ADDTK	AUTH	CBO	CCO	CFNTO	CFRMO	CND	FB	FPEB	ID	MIP	P	RD
										•		

Construction Upgrades

APW	PLE
•	

Door Options

CG	CG.BTM	CG.TOP	MD	MD.BTM	MD.TOP	MFO
						•

Non Soft-close Options

NSCH
•

Price Point

1

2

3

4

5

6

7

8

9

10

11

ARTISAN STRAIGHT WOOD HOOD, 30", 36", or 42" WIDE

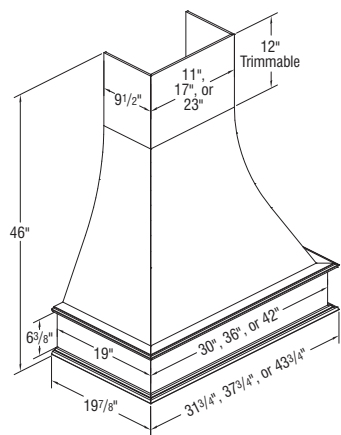

WHAS30

3776

3776

3776

3776

3776

3776

3776

3776

3776

3776

3776

3776

WHAS36

3975

3975

3975

3975

3975

3975

3975

3975

3975

3975

3975

3975

WHAS42

4174

4174

4174

4174

4174

4174

4174

4174

4174

4174

4174

4174

- Freestanding unit (must be properly secured to wall and cannot be attached to adjacent cabinets).
- Exhaust system not included. Compatible with all blowers on page 62.
- Chimney height is trimmable up to 34"
- Check local building code and appliance installation specifications for clearance requirements and installation heights above the range.
- Silver metallic liner included. Assembly required.
- Liner opening size: 10 1/4" deep x 19 1/2" wide.
- Installation instructions and hardware included.
- Painted hardwood will be used for laminate.
- No changes or cancellations will be accepted after 24 hours from acknowledgment of order.

MODIFICATIONS

No modifications available for these products.

WATERFALL WOOD HOOD, 36" or 42" WIDE

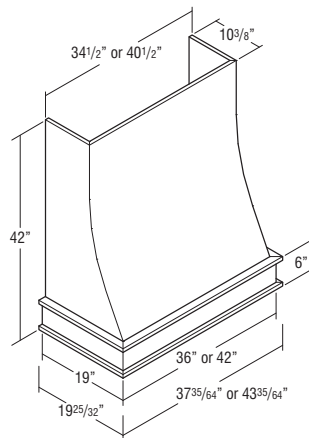

WHWF36

3649

3649

3649

3649

3649

3649

3649

3649

3649

3649

3649

3649

WHWF42

3851

3851

3851

3851

3851

3851

3851

3851

3851

3851

3851

3851

- Freestanding unit (must be properly secured to wall and cannot be attached to adjacent cabinets).
- Exhaust system not included. Compatible with all blowers on page 62.
- Chimney height is trimmable up to 34"
- Check local building code and appliance installation specifications for clearance requirements and installation heights above the range.
- Silver metallic liner included. Assembly required.
- Liner opening size: 10 1/4" deep x 19 1/2" wide.
- Installation instructions and hardware included.
- Painted hardwood will be used for laminate.
- No changes or cancellations will be accepted after 24 hours from acknowledgment of order.

MODIFICATIONS

No modifications available for these products.

CRAFTSMAN STRAIGHT WOOD HOOD, 30" or 36" WIDE

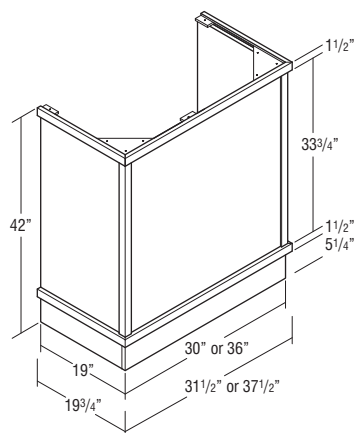

WHCFS30

3140

3140

3140

3140

3140

3140

3140

3140

3140

3140

3140

3140

WHCFS36

3341

3341

3341

3341

3341

3341

3341

3341

3341

3341

3341

3341

- Freestanding unit (must be properly secured to wall and cannot be attached to adjacent cabinets).
- Exhaust system not included. Compatible with all blowers on page 62.
- Check local building code and appliance installation specifications for clearance requirements and installation heights above the range.
- Silver metallic liner included. Assembly required.
- Liner opening size: 10 1/4" deep x 19 1/2" wide.
- Installation instructions and hardware included.
- Painted hardwood will be used for laminate.
- No changes or cancellations will be accepted after 24 hours from acknowledgment of order.

MODIFICATIONS

No modifications available for these products.

NEW SIGNATURE MANTEL WOOD HOOD, 30" or 36" WIDE, 30" or 36" HIGH

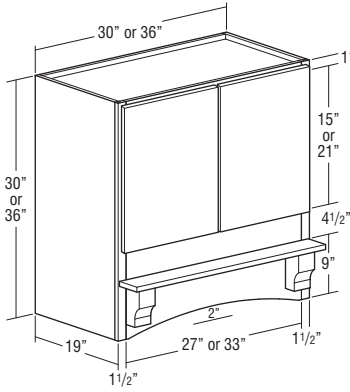

Price Point	1	2	3	4	5	6	7	8	9	10	11
WHSGM3030	3280	3280	3280	3280	3280	3280	3280	3280	3280	3280	3280
WHSGM3036	3619	3619	3619	3619	3619	3619	3619	3619	3619	3619	3619
WHSGM3630	3644	3644	3644	3644	3644	3644	3644	3644	3644	3644	3644
WHSGM3636	4053	4053	4053	4053	4053	4053	4053	4053	4053	4053	4053

- Exhaust system not included. Compatible with all blowers on page 62.
- Operable doors matching the style ordered will be installed on hood.
- Check local building code and appliance installation specifications for clearance requirements and installation heights above the range.
- Silver metallic liner included. Assembly required.
- Liner opening size: 10 1/4" deep x 19 1/2" wide.
- Installation instructions and hardware included.
- Painted hardwood will be used for laminate.
- No changes or cancellations will be accepted after 24 hours from acknowledgment of order.

MODIFICATIONS
No modifications available for these products.

Door Options						
CG	CG.BTM	CG.TOP	MD	MD.BTM	MD.TOP	MFO
						•

Non Soft-close Options
NSCH
•

CLASSIC SQUARE WOOD HOOD, 30", 36", or 42" WIDE

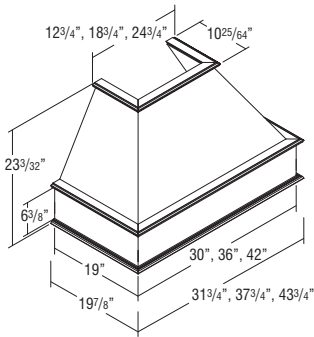

WHS30	3776	3776	3776	3776	3776	3776	3776	3776	3776	3776	3776
WHS36	3975	3975	3975	3975	3975	3975	3975	3975	3975	3975	3975
WHS42	4174	4174	4174	4174	4174	4174	4174	4174	4174	4174	4174

- Freestanding unit (must be properly secured to wall and cannot be attached to adjacent cabinets).
- Exhaust system not included. Compatible with all blowers on page 62.
- Chimney available (WHC.). See below.
- Check local building code and appliance installation specifications for clearance requirements and installation heights above the range.
- Silver metallic liner included. Assembly required.
- Installation instructions and hardware included.
- Liner opening size: 10 1/4" deep by 19 1/2" wide.
- Painted hardwood will be used for laminate.
- No changes or cancellations will be accepted after 24 hours from acknowledgment of order.

MODIFICATIONS
No modifications available for these products.

SQUARE FLAT PANEL WOOD HOOD, 30" or 36" WIDE

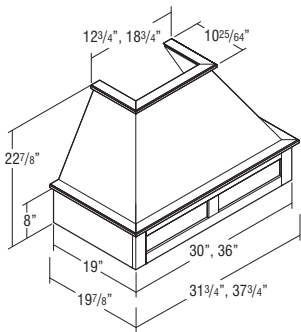

WHSFP30	3935	3935	3935	3935	3935	3935	3935	3935	3935	3935	3935
WHSFP36	3975	3975	3975	3975	3975	3975	3975	3975	3975	3975	3975

- Freestanding unit (must be properly secured to wall and cannot be attached to adjacent cabinets).
- Exhaust system not included. Compatible with all blowers on page 62.
- Chimney available (WHC.). See below.
- Check local building code and appliance installation specifications for clearance requirements and installation heights above the range.
- Silver metallic liner included. Assembly required.
- Installation instructions and hardware included.
- Liner opening size: 10 1/4" deep by 19 1/2" wide.
- Painted hardwood will be used for laminate.
- No changes or cancellations will be accepted after 24 hours from acknowledgment of order.

MODIFICATIONS
No modifications available for these products.

**CLASSIC WOOD HOOD CHIMNEY,
23 1/2" or 31" HIGH**

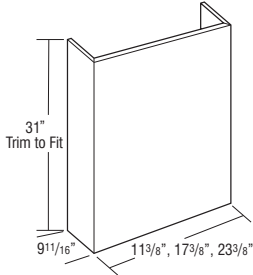
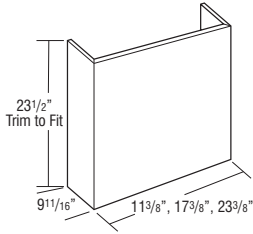

	Price Point	1	2	3	4	5	6	7	8	9	10	11
WHC30		737	737	737	737	737	737	737	737	737	737	737
WHC36		749	749	749	749	749	749	749	749	749	749	749
WHC42		786	786	786	786	786	786	786	786	786	786	786

WHCT30		929	929	929	929	929	929	929	929	929	929	929
WHCT36		944	944	944	944	944	944	944	944	944	944	944
WHCT42		990	990	990	990	990	990	990	990	990	990	990

- 3/4" thick plywood.
- Trimmable.
- If trimmed, moulding is recommended to conceal any cut marks.
- Optional accessory for Wood Hood Square (WHS) and Square Flat Panel Wood Hood (WHSFP).
- WHC30 and WHCT30 are not compatible with CONVERSION.
- Painted hardwood will be used for laminate.
- No changes or cancellations will be accepted after 24 hours from acknowledgment of order.

MODIFICATIONS
No modifications available for these products.

**SHIPLAP TAPERED WOOD HOOD,
30" or 36" WIDE**

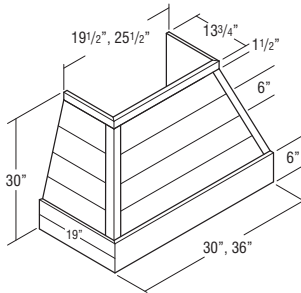

JWHSIPT30	N/A	3988	3988	3988	3988	3988	3988	3988	3988	3988	3988	3988
JWHSIPT36	N/A	4452	4452	4452	4452	4452	4452	4452	4452	4452	4452	4452

- Freestanding unit (must be properly secured to wall and cannot be attached to adjacent cabinets).
- Constructed of 3/4" thick grooved plywood creating a shiplap appearance.
- Exhaust system not included. Compatible with all blowers on page 62.
- Compatible with Shiplap Chimney (JWHSIPCH_), which can be trimmed. See page 59.
- Check local building code and appliance installation specifications for clearance requirements and installation heights above the range.
- Silver metallic liner included. Assembly required.
- Installation instructions and hardware included.
- Liner opening size: 10 1/4" deep by 19 1/2" wide.
- Not available in Oak, Painted hardwood will be used for laminate.
- No changes or cancellations will be accepted after 24 hours from acknowledgment of order.

MODIFICATIONS
No modifications available for these products.

**SHIPLAP WOOD HOOD CHIMNEY,
24 3/4" HIGH**

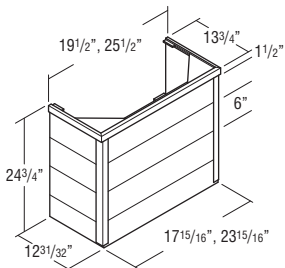

JWHSIPCH30	N/A	1172	1172	1172	1172	1172	1172	1172	1172	1172	1172	1172
JWHSIPCH36	N/A	1172	1172	1172	1172	1172	1172	1172	1172	1172	1172	1172

- Constructed of 3/4" thick grooved plywood creating a shiplap appearance.
- Trimmable. If trimmed, moulding is recommended to conceal any cut marks.
- Optional accessory for Wood Hood Shiplap Tapered (JWHSIPT_) for an installed height of 54".
- Not available in Oak, Painted hardwood will be used for laminate.
- No changes or cancellations will be accepted after 24 hours from acknowledgment of order.

MODIFICATIONS
No modifications available for these products.

SIMPLE TAPERED WOOD HOOD, 30" or 36" WIDE

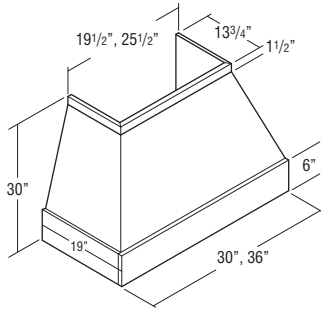

Price Point	1	2	3	4	5	6	7	8	9	10	11
WHSMT30	3988	3988	3988	3988	3988	3988	3988	3988	3988	3988	3988
WHSMT36	4452	4452	4452	4452	4452	4452	4452	4452	4452	4452	4452

- Freestanding unit (must be properly secured to wall and cannot be attached to adjacent cabinets).
- Exhaust system not included. Compatible with all blowers on page 62.
- Compatible with Simple Wood Hood Chimney (WHSMC_), which can be trimmed. See below.
- Check local building code and appliance installation specifications for clearance requirements and installation heights above the range.
- Silver metallic liner included. Assembly required.
- Installation instructions and hardware included.
- Liner opening size: 10 1/4" deep by 19 1/2" wide.
- Painted hardwood will be used for laminate.
- No changes or cancellations will be accepted after 24 hours from acknowledgment of order.

MODIFICATIONS
No modifications available for these products.

SIMPLE WOOD HOOD CHIMNEY, 24 3/4" HIGH

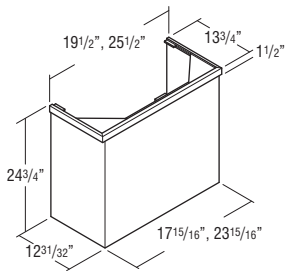

WHSMC30	1172	1172	1172	1172	1172	1172	1172	1172	1172	1172	1172
WHSMC36	1172	1172	1172	1172	1172	1172	1172	1172	1172	1172	1172

- Trimable. If trimmed, moulding is recommended to conceal any cut marks.
- Optional accessory for Simple Tapered Wood Hoods (WHSMT_) for an installed height of 54".
- Painted hardwood will be used for laminate.
- No changes or cancellations will be accepted after 24 hours from acknowledgment of order.

MODIFICATIONS
No modifications available for these products.

CANOPY SQUARE WOOD HOOD, 30" or 36" WIDE

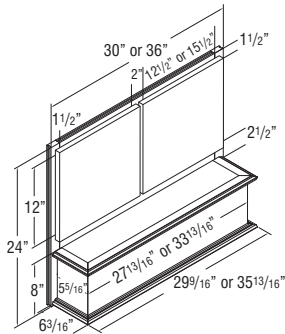

WHCS30	2378	2400	2422	2436	2485	2508	2531	2576	2589	2645	2703
WHCS36	2579	2602	2630	2648	2701	2727	2751	2799	2814	2878	2943

- Install between adjacent cabinets.
- Exhaust system not included. Compatible with all blowers on page 62.
- Check local building code and appliance installation specifications for clearance requirements and installation heights above the range.
- Interior bottom section is finished below liner.
- Square silver metallic liner included. Assembly required.
- Installation instructions and hardware included.
- Liner opening size: 10 1/4" deep by 19 1/2" wide.
- Painted hardwood will be used for laminate.
- No changes or cancellations will be accepted after 24 hours from acknowledgment of order.

Door Options						
CG	CG.BTM	CG.TOP	MD	MD.BTM	MD.TOP	MFO
						•

Non Soft-dose Options
NSCH
•

**STRAIGHT BATTEN WOOD HOOD,
30" or 36" WIDE,
24" or 30" HIGH**

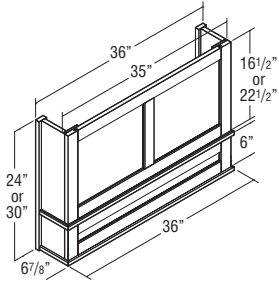
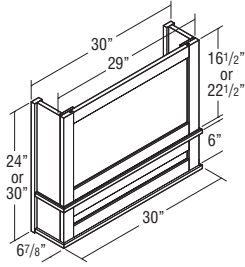

Price Point	1	2	3	4	5	6	7	8	9	10	11
WHSBATTEN3024	2940	2940	2940	2940	2940	2940	2940	2940	2940	2940	2940
WHSBATTEN3030	3280	3280	3280	3280	3280	3280	3280	3280	3280	3280	3280

WHSBATTEN3624	3235	3235	3235	3235	3235	3235	3235	3235	3235	3235	3235
WHSBATTEN3630	3644	3644	3644	3644	3644	3644	3644	3644	3644	3644	3644

- Install between adjacent cabinets.
- Exhaust system not included. Compatible with all blowers on page 62.
- Check local building code and appliance installation specifications for clearance requirements and installation heights above the range.
- Silver metallic liner included. Assembly required.
- Installation instructions and hardware included.
- Liner opening size: 10 1/4" deep by 19 1/2" wide.
- End rails, side stiles, and center stiles are 2 1/4" wide.
- Grain runs vertical on center panels in upper section and horizontal on center panel in lower section.
- Painted hardwood will be used for laminate.
- No changes or cancellations will be accepted after 24 hours from acknowledgment of order.

MODIFICATIONS
No modifications available for these products.

**STRAIGHT BATTEN WOOD HOOD,
30" or 36" WIDE, 36" HIGH**

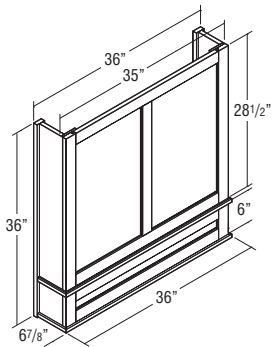
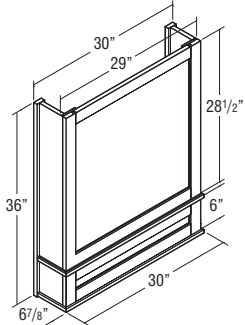

WHSBATTEN3036	3619	3619	3619	3619	3619	3619	3619	3619	3619	3619	3619
----------------------	------	------	------	------	------	------	------	------	------	------	------

WHSBATTEN3636	4053	4053	4053	4053	4053	4053	4053	4053	4053	4053	4053
----------------------	------	------	------	------	------	------	------	------	------	------	------

- Install between adjacent cabinets.
- Exhaust system not included. Compatible with all blowers on page 62.
- Check local building code and appliance installation specifications for clearance requirements and installation heights above the range.
- Silver metallic liner included. Assembly required.
- Installation instructions and hardware included.
- Liner opening size: 10 1/4" deep by 19 1/2" wide.
- End rails, side stiles, and center stiles are 2 1/4" wide.
- Grain runs vertical on center panels in upper section and horizontal on center panel in lower section.
- Painted hardwood will be used for laminate.
- No changes or cancellations will be accepted after 24 hours from acknowledgment of order.

MODIFICATIONS
No modifications available for these products.

**TAPERED WOOD HOOD,
30" or 36" WIDE, 24" HIGH**

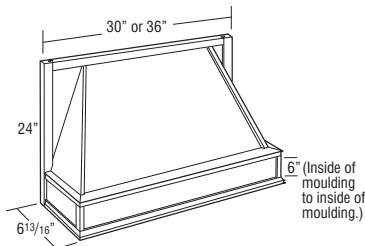

TWH30	1368	1368	1368	1368	1368	1368	1368	1368	1368	1368	1368
TWH36FW	1469	1469	1469	1469	1469	1469	1469	1469	1469	1469	1469

- Install between adjacent cabinets.
- Exhaust system not included. Compatible with all blowers on page 62.
- Check local building code and appliance installation specifications for clearance requirements and installation heights above the range.
- Tapered design.
- Liner opening size: 10 1/4" deep x 19 1/2" wide.
- Silver metallic liner included, not available for order separately.
- Painted hardwood will be used for laminate.
- No changes or cancellations will be accepted after 24 hours from acknowledgment of order.

MODIFICATIONS
No modifications available for these products.

Price Point

WOOD HOOD BLOWER, 600 CFM

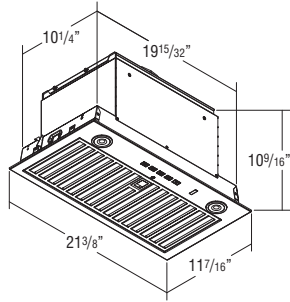

BLOWER600

1	2	3	4	5	6	7	8	9	10	11
3005	3005	3005	3005	3005	3005	3005	3005	3005	3005	3005

- 600 CFM.
- Two 3 watt (300+ Lumens, 3 settings) LED lights included.
- Installation instructions, warranty, and repair information included.
- Stainless Steel finish.
- Four speed push button control.
- Includes removable dishwasher safe grease filter.
- WIFI Enabled, Auto-Sensing, and Heat Sentry technology included.
- 1 year warranty.
- Compatible with all Wood Hoods.

MODIFICATIONS

No modifications available for these products.

WOOD HOOD BLOWER, 400 CFM

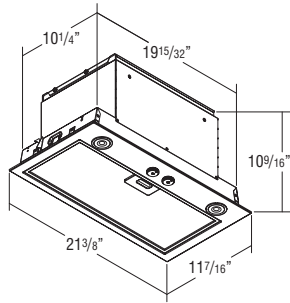

BLOWER400

1411	1411	1411	1411	1411	1411	1411	1411	1411	1411	1411
------	------	------	------	------	------	------	------	------	------	------

- 400 CFM, Energy Star rated.
- Two 2.8 watt (250+ Lumens) LED lights included.
- Installation instructions, warranty, and repair information included.
- Stainless Steel finish.
- Three speed rotary switch control.
- Includes removable dishwasher safe grease filter.
- Heat Sentry technology included.
- 1 year warranty.
- Compatible with all Wood Hoods.

MODIFICATIONS

No modifications available for these products.

WOOD HOOD INTERIOR DUCTWORK CONVERSION KIT

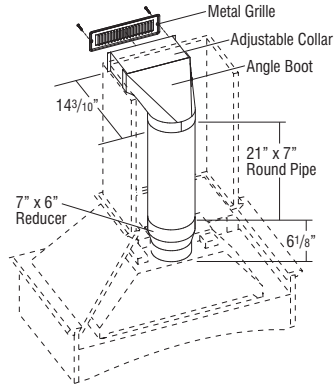

CONVERSION

285	285	285	285	285	285	285	285	285	285	285
-----	-----	-----	-----	-----	-----	-----	-----	-----	-----	-----

FILTERCHAR

132	132	132	132	132	132	132	132	132	132	132
-----	-----	-----	-----	-----	-----	-----	-----	-----	-----	-----

- CONVERSION includes: (1) 21" x 7" round pipe, (1) adjustable collar, (1) white metal soffit grille (11 3/8" x 3 5/8"), (1) angle boot, (1) 7" x 6" reducer, filter and installation instructions.
- CONVERSION is not compatible with WHC30.
- CONVERSION is compatible with all blowers on this page.
- FILTERCHAR for use in all blowers on this page.
- FILTERCHAR is a replacement charcoal filter used to provide proper filtration for air recirculation when a conversion kit is used. The filter attaches to the inside of the removable mesh metal filter in the blower.

MODIFICATIONS

No modifications available for these products.

TABLE OF CONTENTS – BASE CABINETS

Base Cabinets with Drawers64
Full Height Base Cabinets65
Base Organization, Base with Roll Trays, and Specialty Cabinets66
Sink Base Cabinets68
Corner Base Cabinets75
Drawer Base Cabinets78
Wastebaskets80
Pull-outs81
Appliance Base Cabinets83
Base Corner Peninsula Cabinets84

BASE CABINETS

BASE CABINET NOMENCLATURE

All Base Cabinets are 34 1/2" high and 24" deep unless otherwise noted.

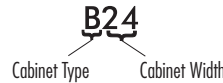

CONSTRUCTION UPGRADES

Mod.	Description
APW	All-plywood Construction
PLE	Plywood Ends

NON SOFT-CLOSE OPTIONS

Mod.	Description
NSCFB	Non Soft-close Guides & Furniture Board Drawers and Roll Trays
NSCH	Non Soft-close Door Hinges

MODIFICATIONS GRID KEY

Mod.	Description
•	Available
STD	Standard on these cabinets
	5 Day Express Response Item

CUSTOM MODIFICATIONS

Mod.	Description
AUTHB	Authentic End - Both
AUTHL	Authentic End - Left
AUTHR	Authentic End - Right
CBO	Cabinet Box Only
CCO	Cabinet Case Only
CFNTO	Cabinet Front Only
CFP	Cabinet False Panel
CFRMO	Cabinet Frame Only
CND	Cabinet with No Door, with Drawer
FB	Finished Ends
FD	Full Depth Shelf
FPEB	Furniture Finished Plywood End Panels
FTK	Flush Toekick
FTKAV	Flush Toekick Arch
FTKFV	Flush Toekick Furniture
MIP	Matching Interior Plywood
P	Peninsula
RD	Reduced Depth
RECTKALL	Recessed Island Toekick
RECTKBK	Recessed Toekick Back
RECTKL	Recessed Toekick Left
RECTKR	Recessed Toekick Right
RT	Installed Roll Tray
VTK	Void Toekick

Cabinets are shipped with an unfinished toekick. Finished toekicks in matching wood veneer or laminate must be ordered separately and field installed.

Drawer box reduces in depth in 3" increments. Spacer blocks are used for drawer hardware.

Heat shields are available for field installation. See page 152.

FPEB modification is recommended for non-stacking applications. Use a 1/4" skin for stacking applications.

BASE SINGLE DOOR

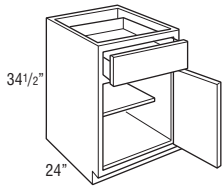

	Price Point	1	2	3	4	5	6	7	8	9	10	11
B9 L or R		499	524	580	618	669	695	706	759	774	846	912
B12 L or R		499	524	580	618	669	695	706	759	774	846	912
B15 L or R		537	565	620	662	716	743	758	817	834	908	982
B18 L or R		571	597	660	706	761	788	802	867	885	967	1045
B21 L or R		609	639	704	752	812	843	860	929	948	1029	1113
B24 L or R		650	684	751	800	865	898	916	986	1006	1099	1190

• Adjustable 15" deep shelves.

Custom Modifications

AUTH	CBO	CCO	CFNTO	CFP	CFRMO	CND	FB	FD	FPEB	FTK	FTK_V	MIP	P	RD	RECTKALL/BK	RECTKL/R	RT	VTK
•	•	•	•	•	•	•	•	•	•	•	• ¹	•	• ²	•	• ³	•	• ²	•

Construction Upgrades

APW	PLE
•	•

Non Soft-close Options

NSCFB	NSCH
•	•

¹ Not available on 9" or 12" wide

² Not available on 9" wide

³ RECTKALL not available

BASE DOUBLE DOOR

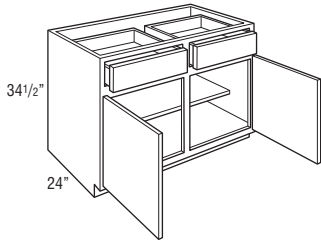
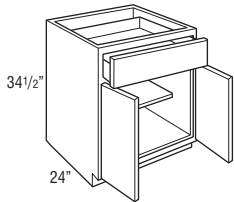

B24	756	795	873	930	1006	1044	1067	1147	1171	1277	1380
B27	789	832	913	975	1056	1096	1116	1201	1226	1337	1444
B30	819	861	948	1012	1095	1135	1160	1249	1275	1388	1500
B33	858	902	993	1060	1147	1191	1213	1308	1334	1454	1572
B36	899	945	1039	1109	1200	1245	1266	1367	1395	1519	1642

B39	941	991	1090	1162	1258	1305	1330	1433	1462	1594	1724
B42	984	1034	1141	1217	1315	1365	1392	1498	1528	1667	1803
B45	1028	1082	1189	1272	1375	1425	1454	1568	1600	1743	1885
B48CS	1043	1098	1212	1296	1405	1459	1488	1605	1638	1789	1938

• Adjustable 15" deep shelves.

Custom Modifications

AUTH	CBO	CCO	CFNTO	CFP	CFRMO	CND	FB	FD	FPEB	FTK	FTK_V	MIP	P	RD	RECTKALL/BK	RECTKL/R	RT	VTK
•	•	•	•	•	•	•	•	•	•	•	•	•	•	•	• ¹	•	•	•

Construction Upgrades

APW	PLE
•	•

Non Soft-close Options

NSCFB	NSCH
•	•

¹ RECTKALL not available on 24" wide

FULL HEIGHT BASE SINGLE DOOR, 6" WIDE

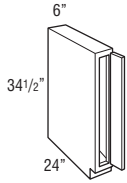

Price Point	1	2	3	4	5	6	7	8	9	10	11
B6FH L or R	432	453	489	521	543	553	583	614	653	707	736

- Frame opening is 3" wide.
- Cabinet has a full top panel.
- Utilizes a 5 1/2" wide overlay filler as a hinged door for full and partial overlay styles.
- All overlays will match the door style outside profile unless a noted exception is listed in the door style section. Certain door style overlays will be painted hardwood. See Door Style section for exceptions.

Custom Modifications

AUTH	CBO	CCO	CFNTO	CFP	CFRMO	CND	FB	FD	FPEB	FTK	FTK_V	MIP	P	RD	RECTKALL/BK	RECTKL/R	RT	VTK
		•	•		•		•		•	•		•		•				•

Construction Upgrades

APW	PLE
•	•

Non Soft-close Options

NSCFB	NSCH
	•

FULL HEIGHT BASE SINGLE DOOR

9", 12", 15", 18", 21", or 24"

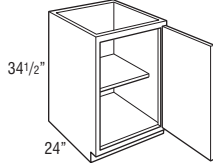

B9FH L or R	432	453	501	535	565	581	609	648	672	731	773
B12FH L or R	456	479	524	563	600	619	640	685	707	769	812
B15FH L or R	490	513	566	604	641	660	692	722	759	827	858
B18FH L or R	519	545	601	643	676	693	733	768	807	879	912
B21FH L or R	553	583	639	685	731	753	783	832	863	937	989
B24FH L or R	591	618	677	727	788	817	833	894	912	997	1080

- Adjustable 15" deep shelf.

Custom Modifications

AUTH	CBO	CCO	CFNTO	CFP	CFRMO	CND	FB	FD	FPEB	FTK	FTK_V	MIP	P	RD	RECTKALL/BK	RECTKL/R	RT	VTK
•	•	•	•		•		•	•	•	•	• ¹	•	• ²	•	• ³	•	• ²	•

Construction Upgrades

APW	PLE
•	•

Non Soft-close Options

NSCFB	NSCH
	•

¹ Not available on 9" or 12" wide

² Not available on 9" wide

³ RECTKALL not available

FULL HEIGHT BASE DOUBLE DOOR

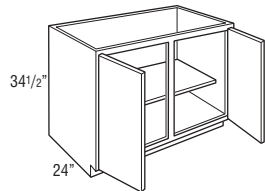
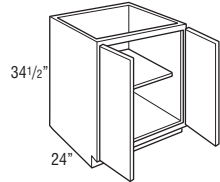

B24FH	712	750	825	881	907	919	945	970	1030	1113	1150
B27FH	751	795	873	930	976	1000	1052	1104	1171	1263	1312
B30FH	769	808	888	947	1019	1053	1086	1152	1193	1299	1370
B33FH	780	821	904	966	1044	1082	1104	1191	1216	1323	1432
B36FH	818	860	947	1010	1092	1133	1156	1245	1271	1384	1468

B39FH	857	901	992	1059	1145	1188	1209	1305	1332	1450	1568
B42FH	896	942	1036	1106	1198	1243	1264	1362	1390	1517	1640
B45FH	1003	1073	1182	1246	1294	1318	1388	1459	1547	1674	1734
B48FHCS	1062	1156	1229	1306	1357	1383	1459	1535	1626	1759	1823

- Adjustable 15" deep shelf.

Custom Modifications

AUTH	CBO	CCO	CFNTO	CFP	CFRMO	CND	FB	FD	FPEB	FTK	FTK_V	MIP	P	RD	RECTKALL/BK	RECTKL/R	RT	VTK
•	•	•	•		•		•	•	•	•	•	•	•	•	• ¹	•	•	•

Construction Upgrades

APW	PLE
•	•

Non Soft-close Options

NSCFB	NSCH
	•

¹ RECTKALL not available on 24" wide

30" SUPERCABINET™

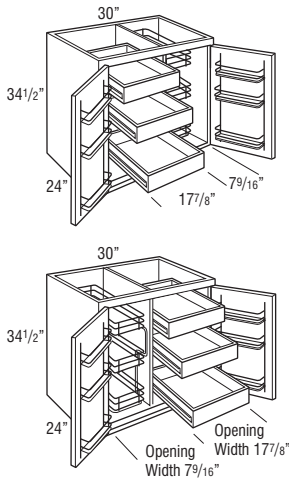

Price Point	1	2	3	4	5	6	7	8	9	10	11
BSC30RP	1657	1696	1776	1835	1907	1941	1974	2040	2081	2187	2258

BSC30PR	1657	1696	1776	1835	1907	1941	1974	2040	2081	2187	2258
----------------	------	------	------	------	------	------	------	------	------	------	------

- Nomenclature represents left to right order of interior components.
Example: BSC30PR = Base SuperCabinet™ 30" Pull-out Roll-out.
- Cabinets utilize 170° hinge. For sufficient pull-out clearance, 12" of adjacent space is required for door to open 170° when installed near a wall or corner.
- Both doors have chrome and wood three-tiered racks.
- Door rack width is 9 3/8".
- Door rack depth is 3".
- Integrated soft-close hinge not included. Premium door mechanism installed.

Custom Modifications

AUTH	CBO	CCO	CFNTO	CFP	CFRMO	CND	FB	FD	FPEB	FTK	FTK_V	MIP	P	RD	RECTKALL/BK	RECTKL/R	RT	VTK
•	•	•				•			•	•	•	•			•	•		•

Construction Upgrades

APW	PLE
•	•

Non Soft-dose Options

NSCFB	NSCH
	STD

36" SUPERCABINET™

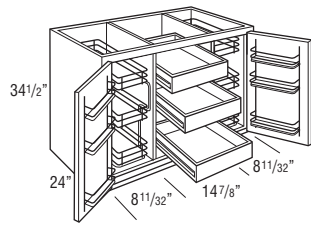

BSC36PRP	2198	2240	2327	2390	2472	2513	2536	2625	2651	2764	2848
-----------------	------	------	------	------	------	------	------	------	------	------	------

- Nomenclature represents left to right order of interior components.
Example: BSC36PRP = Base SuperCabinet™ 36" Pull-out Roll-out Pull-out.
- Cabinets utilize 170° hinge. For sufficient pull-out clearance, 12" of adjacent space is required for door to open 170° when installed near a wall or corner.
- Both doors have chrome and wood three-tiered racks.
- Door rack width is 12 3/8".
- Door rack depth is 3".
- Integrated soft-close hinge not included. Premium door mechanism installed.

Custom Modifications

AUTH	CBO	CCO	CFNTO	CFP	CFRMO	CND	FB	FD	FPEB	FTK	FTK_V	MIP	P	RD	RECTKALL/BK	RECTKL/R	RT	VTK
•	•	•				•			•	•	•	•			•	•		•

Construction Upgrades

APW	PLE
•	•

Non Soft-dose Options

NSCFB	NSCH
	STD

BASE SINGLE DOOR with ROLL TRAYS

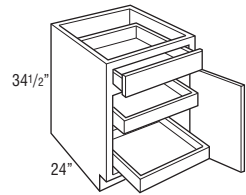

B12RT L or R	785	810	866	904	955	981	992	1045	1060	1132	1198
B15RT L or R	823	851	906	948	1002	1029	1044	1103	1120	1194	1268
B18RT L or R	857	883	946	992	1047	1074	1088	1153	1171	1253	1331
B21RT L or R	895	925	990	1038	1098	1129	1146	1215	1234	1315	1399
B24RT L or R	936	970	1037	1086	1151	1184	1202	1272	1292	1385	1476

- 2 roll trays standard.
- Cabinets may accommodate up to 4 roll trays, which may be purchased separately for field installation. See page 154.

Custom Modifications

AUTH	CBO	CCO	CFNTO	CFP	CFRMO	CND	FB	FD	FPEB	FTK	FTK_V	MIP	P	RD	RECTKALL/BK	RECTKL/R	RT	VTK
•	•	•	•	•	•	•	•	•	•	•	• ¹	•	•	•	• ²	•	•	•

Construction Upgrades

APW	PLE
•	•

Non Soft-dose Options

NSCFB	NSCH
•	•

¹ Not available on 12" wide
² RECTKALL not available

BASE DOUBLE DOOR with ROLL TRAYS

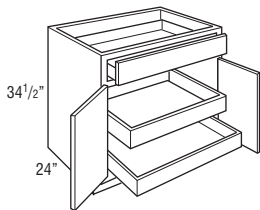

B24RT	1042	1081	1159	1216	1292	1330	1353	1433	1457	1563	1666
B27RT	1075	1118	1199	1261	1342	1382	1402	1487	1512	1623	1730
B30RT	1105	1147	1234	1298	1381	1421	1446	1535	1561	1674	1786
B33RT	1144	1188	1279	1346	1433	1477	1499	1594	1620	1740	1858
B36RT	1185	1231	1325	1395	1486	1531	1552	1653	1681	1805	1928

- 2 roll trays standard.
- Cabinet has butt doors, no center stile.
- Cabinet may accommodate up to 4 roll trays, which may be purchased separately for field installation. See page 154.

Custom Modifications

AUTH	CBO	CCO	CFNTO	CFP	CFRMO	CND	FB	FD	FPEB	FTK	FTK_V	MIP	P	RD	RECTKALL/BK	RECTKL/R	RT	VTK
•	•	•	•	•	•	•	•	•	•	•	•	•	•	•	• ¹	•	•	•

Construction Upgrades

APW	PLE
•	•

Non Soft-dose Options

NSCFB	NSCH
•	•

¹ RECTKALL not available on 24" wide

BASE DOUBLE DOOR with ROLL TRAYS

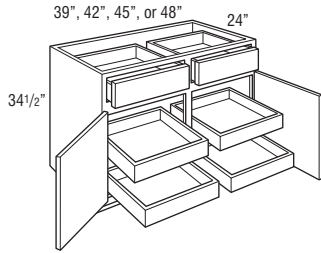

Price Point	1	2	3	4	5	6	7	8	9	10	11
B39RT	1513	1563	1662	1734	1830	1877	1902	2005	2034	2166	2296
B42RT	1556	1606	1713	1789	1887	1937	1964	2070	2100	2239	2375
B45RT	1600	1654	1761	1844	1947	1997	2026	2140	2172	2315	2457
B48CSRT	1615	1670	1784	1868	1977	2031	2060	2177	2210	2361	2510

- 4 roll trays standard.
- Cabinet may accommodate up to 8 roll trays, which may be purchased separately for field installation. See page 154.

Custom Modifications

AUTH	CBO	CCO	CFNTO	CFP	CFRMO	CND	FB	FD	FPEB	FTK	FTK_V	MIP	P	RD	RECTKALL/BK	RECTKL/R	RT	VTK
•	•	•	•	•	•	•	•	•	•	•	•	•	•	•	•	•	•	•

Construction Upgrades

APW	PLE
•	•

Non Soft-close Options

NSCFB	NSCH
•	•

BASE with ROLL-OUT TRAY DIVIDER

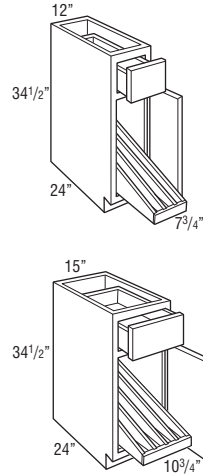

B12DRO L or R	907	932	988	1026	1077	1103	1114	1167	1182	1254	1320
----------------------	-----	-----	-----	------	------	------	------	------	------	------	------

B15DRO L or R	982	1010	1065	1107	1161	1188	1203	1262	1279	1353	1427
----------------------	-----	------	------	------	------	------	------	------	------	------	------

- Tray divider utilizes soft-close undermount guides.
- Dividers are removable.
- 12" - 3 compartments.
- 15" - 4 compartments.
- Roll-out Tray Dividers are also available as an accessory for field installation. See page 153.

Custom Modifications

AUTH	CBO	CCO	CFNTO	CFP	CFRMO	CND	FB	FD	FPEB	FTK	FTK_V	MIP	P	RD	RECTKALL/BK	RECTKL/R	RT	VTK
•	•	•	•	•	•	•	•	•	•	•	• ¹	•	•	•	• ²	•	•	•

Construction Upgrades

APW	PLE
•	•

Non Soft-close Options

NSCFB	NSCH
	•

¹ Not available on 12" wide
² RECTKALL not available

BASE with TRAY DIVIDER

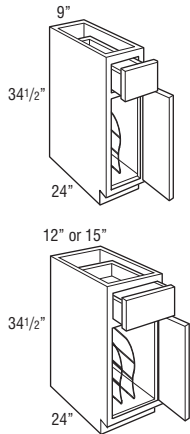

TD9 L or R	533	555	605	639	686	708	719	767	780	845	904
-------------------	-----	-----	-----	-----	-----	-----	-----	-----	-----	-----	-----

TD12 L or R	582	607	663	701	752	778	789	842	857	929	995
--------------------	-----	-----	-----	-----	-----	-----	-----	-----	-----	-----	-----

TD15 L or R	620	648	703	745	799	826	841	900	917	991	1065
--------------------	-----	-----	-----	-----	-----	-----	-----	-----	-----	-----	------

- Tray Divider is chrome.
- Tray Divider is also available as an accessory for field installation. See page 153.
- Divider is removable for easy cleaning.

Custom Modifications

AUTH	CBO	CCO	CFNTO	CFP	CFRMO	CND	FB	FD	FPEB	FTK	FTK_V	MIP	P	RD	RECTKALL/BK	RECTKL/R	RT	VTK
•	•	•	•	•	•	•	•	•	•	•	• ¹	•	•	•	• ²	•	•	•

Construction Upgrades

APW	PLE
•	•

Non Soft-close Options

NSCFB	NSCH
•	•

¹ Not available on 9" or 12" wide
² RECTKALL not available

BASE FULL HEIGHT with TRAY DIVIDER

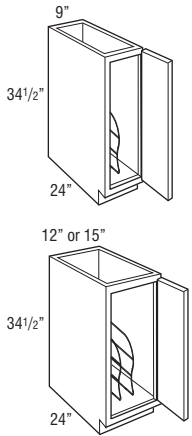

	Price Point	1	2	3	4	5	6	7	8	9	10	11
TD9FH L or R		515	536	584	618	648	664	692	731	755	814	856
TD12FH L or R		539	562	607	646	683	702	723	768	790	852	895
TD15FH L or R		573	596	649	687	724	743	775	805	842	910	941

- Tray Divider is chrome.
- Tray Divider is also available as an accessory for field installation. See page 153.
- Divider is removable for easy cleaning.

Custom Modifications

AUTH	CBO	CCO	CFNTO	CFP	CFRMO	CND	FB	FD	FPEB	FTK	FTK_V	MIP	P	RD	RECTKALL/BK	RECTKL/R	RT	VTK
•	•	•	•	•	•	•	•	•	•	•	• ¹	•	•	•	• ²	•	•	•

Construction Upgrades

APW	PLE
•	•

Non Soft-close Options

NSCFB	NSCH
	•

¹ Not available on 9" or 12" wide
² RECTKALL not available

BASE CABINET with MIXER SHELF

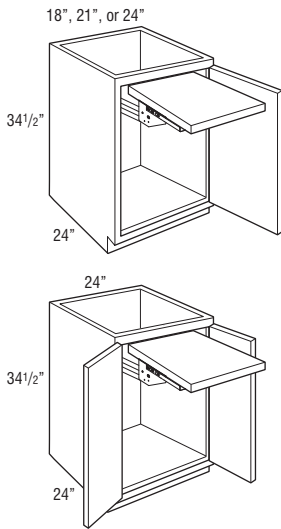

B18FHMIXSC L or R	1750	1776	1832	1874	1907	1924	1964	1999	2038	2109	2143
B21FHMIXSC L or R	1919	1949	2005	2051	2097	2120	2150	2198	2229	2303	2356
B24FHMIXSC L or R	2095	2122	2181	2232	2292	2321	2337	2398	2416	2501	2584

B24FHMIXSC	2216	2254	2329	2385	2411	2423	2449	2475	2534	2617	2654
-------------------	------	------	------	------	------	------	------	------	------	------	------

- Includes mixer lift with soft-close closing feature.
- Mixer shelf will be 3/4" thick, mixer shelf dimensions:
 18" wide: 11 3/4" wide x 20" deep.
 21" wide: 14 3/4" wide x 20" deep.
 24" wide: 17 3/4" wide x 20" deep.
- Maximum Weight Capacity for Mixer Shelf: 60 lbs.
- Mixer shelf locks in the fully open position. Release brackets lower the mixer shelf back into the cabinet.
- When in closed position, clearance above shelf is 17 5/8"; clearance below shelf is 7 3/4".
- Mixer shelf is not intended to support mixer while mixer is in use.

Custom Modifications

AUTH	CBO	CCO	CFNTO	CFP	CFRMO	CND	FB	FD	FPEB	FTK	FTK_V	MIP	P	RD	RECTKALL/BK	RECTKL/R	RT	VTK
•	•	•	•	•	•	•	•	•	•	•	•	•	•	•	• ¹	•	•	•

Construction Upgrades

APW	PLE
•	•

Non Soft-close Options

NSCFB	NSCH
	•

¹ RECTKALL not available

SINK BASE

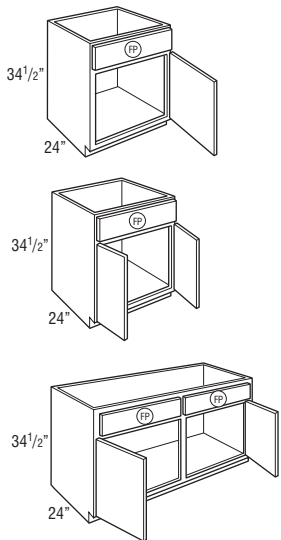

SB21 L or R	544	571	628	671	726	753	767	826	843	919	993
SB24 L or R	572	601	660	706	764	792	807	870	888	967	1045

SB24	657	690	758	809	858	883	924	966	1015	1108	1146
SB27	683	721	789	843	905	936	964	1041	1062	1157	1234
SB30	706	744	819	872	944	979	997	1076	1098	1198	1294
SB33	733	768	848	903	977	1014	1032	1116	1138	1239	1342
SB36	762	800	882	942	1019	1056	1078	1161	1184	1290	1396

SB39	802	843	928	992	1071	1110	1132	1222	1247	1359	1470
SB42	837	881	970	1035	1119	1161	1185	1276	1302	1417	1536
SB45	879	924	1022	1088	1178	1221	1243	1339	1366	1489	1611
SB48CS	1012	1098	1197	1264	1309	1331	1399	1467	1556	1682	1745

- Mini Touch-up Kit (MTUK) included. MTUK includes small touch-up marker and small fill stick.

Custom Modifications

AUTH	CBO	CCO	CFNTO	CFP	CFRMO	CND	FB	FD	FPEB	FTK	FTK_V	MIP	P	RD	RECTKALL/BK	RECTKL/R	RT	VTK
•	•	•	•	•	•	•	•	•	•	•	•	•	•	•	• ¹	•	•	•

Construction Upgrades

APW	PLE
•	•

Non Soft-close Options

NSCFB	NSCH
	•

¹ RECTKALL not available on 21" or 24" wide

FP = False Panel

SINK BASE with CABMAT™

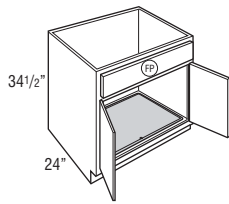

FP = False Panel

	Price Point	1	2	3	4	5	6	7	8	9	10	11
SB30CM		1006	1044	1119	1172	1244	1279	1297	1376	1398	1498	1594
SB33CM		1033	1068	1148	1203	1277	1314	1332	1416	1438	1539	1642
SB36CM		1062	1100	1182	1242	1319	1356	1378	1461	1484	1590	1696

- Mini Touch-up Kit (MTUK) included. MTUK includes small touch-up marker and small fill stick.
- CabMat™ is designed to capture spills and is removable for cleaning.
- CabMat™ also available for field installation. See page 151.

Custom Modifications

AUTH	CBO	CCO	CFNT0	CFP	CFRMO	CND	FB	FD	FPEB	FTK	FTK_V	MIP	P	RD	RECTKALL/BK	RECTKL/R	RT	VTK
•	•	•	•	STD	•	•	•	•	•	•	•	•	•	•	•	•	•	•

Construction Upgrades

APW	PLE
•	•

Non Soft-close Options

NSCFB	NSCH
	•

SINK BASE, 27" DEEP

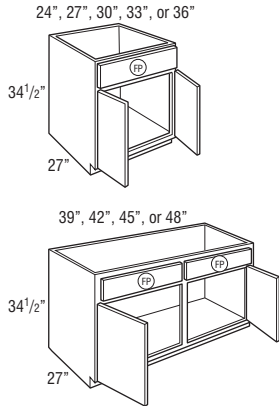

FP = False Panel

SB243427	807	840	908	959	1008	1033	1074	1116	1165	1258	1296
SB273427	833	871	939	993	1055	1086	1114	1191	1212	1307	1384
SB303427	856	894	969	1022	1094	1129	1147	1226	1248	1348	1444
SB333427	883	918	998	1053	1127	1164	1182	1266	1288	1389	1492
SB363427	912	950	1032	1092	1169	1206	1228	1311	1334	1440	1546

SB393427	952	993	1078	1142	1221	1260	1282	1372	1397	1509	1620
SB423427	987	1031	1120	1185	1269	1311	1335	1426	1452	1567	1686
SB453427	1029	1074	1172	1238	1328	1371	1393	1489	1516	1639	1761
SB483427CS	1162	1248	1347	1414	1459	1481	1549	1617	1706	1832	1895

- Mini Touch-up Kit (MTUK) included. MTUK includes small touch-up marker and small fill stick.

Custom Modifications

AUTH	CBO	CCO	CFNT0	CFP	CFRMO	CND	FB	FD	FPEB	FTK	FTK_V	MIP	P	RD	RECTKALL/BK	RECTKL/R	RT	VTK
		•	•	STD	•	•	•	•	•	•	•	•	•	•	• ¹	•	•	•

Construction Upgrades

APW	PLE
•	•

Non Soft-close Options

NSCFB	NSCH
	•

¹ RECTKALL not available on 24" wide

SINK BASE with TILT-OUT TRAYS

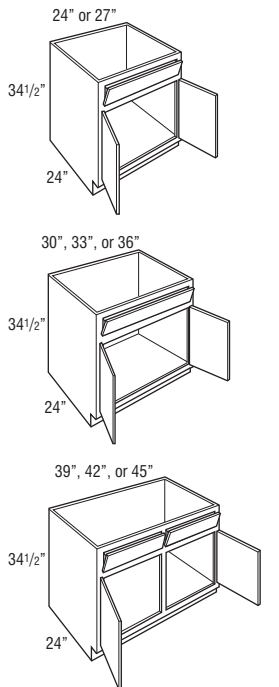

FP = False Panel

SB24ST	748	782	858	907	979	1015	1035	1114	1136	1240	1329
SB27ST	759	792	870	919	991	1026	1047	1126	1150	1250	1339

SB30ST	771	805	880	929	1003	1039	1058	1136	1160	1262	1350
SB33ST	798	832	911	961	1035	1071	1091	1172	1196	1302	1393
SB36ST	834	870	950	1004	1082	1122	1142	1226	1250	1361	1459

SB39ST	874	912	994	1052	1135	1175	1198	1285	1311	1427	1527
SB42ST	937	978	1063	1122	1207	1249	1273	1367	1395	1512	1616
SB45ST	959	1000	1085	1144	1230	1273	1294	1388	1416	1534	1638

- Tilt-out trays are stain resistant, moisture resistant plastic to allow storage of sponges and other cleaning materials.
- Clean tilt-out trays using a mild soap and water. Avoid scalding water.
- Mini Touch-up Kit (MTUK) included. MTUK includes small touch-up marker and small fill stick.
- Includes two tilt-out trays on 30"-45" wide.
- Tilt-out trays are also available as an accessory for field installation. See page 153.

Custom Modifications

AUTH	CBO	CCO	CFNT0	CFP	CFRMO	CND	FB	FD	FPEB	FTK	FTK_V	MIP	P	RD	RECTKALL/BK	RECTKL/R	RT	VTK
•		•			•	•	•	•	•	•	•	•	•	•	• ¹	•	•	•

Construction Upgrades

APW	PLE
•	•

Non Soft-close Options

NSCFB	NSCH
	•

¹ RECTKALL not available on 24" wide

SINK BASE with TILT-OUT TRAYS and CABMAT™

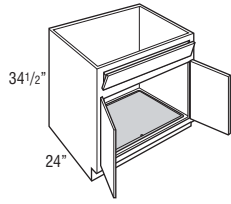

Price Point

	1	2	3	4	5	6	7	8	9	10	11
SB30STCM	1071	1105	1180	1229	1303	1339	1358	1436	1460	1562	1650
SB33STCM	1098	1132	1211	1261	1335	1371	1391	1472	1496	1602	1693
SB36STCM	1134	1170	1250	1304	1382	1422	1442	1526	1550	1661	1759

- Mini Touch-up Kit (MTUK) included. MTUK includes small touch-up marker and small fill stick.
- CabMat™ is designed to capture spills and is removable for cleaning.
- Tilt-out trays are stain resistant, moisture resistant plastic to allow storage of sponges and other cleaning materials.
- Clean tilt-out trays using a mild soap and water. Avoid scalding water.
- Includes two tilt-out trays.
- Tilt-out trays are also available as an accessory for field installation. See page 153.
- CabMat™ also available for field installation. See page 151.

Custom Modifications

AUTH	CBO	CCO	CFNTO	CFP	CFRMO	CND	FB	FD	FPEB	FTK	FTK_V	MIP	P	RD	RECTKALL/BK	RECTKL/R	RT	VTK
•	•	•				•	•		•	•	•	•			•	•		•

Construction Upgrades

APW	PLE
•	•

Non Soft-dose Options

NSCFB	NSCH
	•

SINK BASE with TILT-OUT TRAYS, 27" DEEP

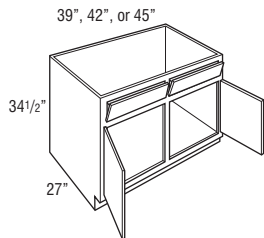
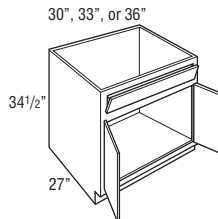
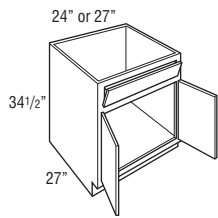

SB243427ST	898	932	1008	1057	1129	1165	1185	1264	1286	1390	1479
SB273427ST	909	942	1020	1069	1141	1176	1197	1276	1300	1400	1489

SB303427ST	921	955	1030	1079	1153	1189	1208	1286	1310	1412	1500
SB333427ST	948	982	1061	1111	1185	1221	1241	1322	1346	1452	1543
SB363427ST	984	1020	1100	1154	1232	1272	1292	1376	1400	1511	1609

SB393427ST	1024	1062	1144	1202	1285	1325	1348	1435	1461	1577	1677
SB423427ST	1087	1128	1213	1272	1357	1399	1423	1517	1545	1662	1766
SB453427ST	1109	1150	1235	1294	1380	1423	1444	1538	1566	1684	1788

- Mini Touch-up Kit (MTUK) included. MTUK includes small touch-up marker and small fill stick.
- Tilt-out trays are stain resistant, moisture resistant plastic to allow storage of sponges and other cleaning materials.
- Clean tilt-out trays using a mild soap and water. Avoid scalding water.
- Includes two tilt-out trays on 30"-45" wide.
- Tilt-out trays are also available as an accessory for field installation. See page 153.

Custom Modifications

AUTH	CBO	CCO	CFNTO	CFP	CFRMO	CND	FB	FD	FPEB	FTK	FTK_V	MIP	P	RD	RECTKALL/BK	RECTKL/R	RT	VTK
		•				•	•		•	•	•	•			• ¹	•		•

Construction Upgrades

APW	PLE
•	•

Non Soft-dose Options

NSCFB	NSCH
	•

¹ RECTKALL not available on 24" wide

SINK BASE SUPERCABINET™ with TILT-OUT TRAYS

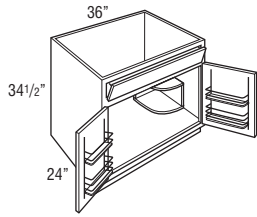

Price Point	1	2	3	4	5	6	7	8	9	10	11
SB36STS	1252	1288	1368	1422	1500	1540	1560	1644	1668	1779	1877

- Quarter Round Reversible Shelf for left or right applications will be constructed from 3/4" thick laminated furniture board. (Shelf shipped secure, can be positioned in left or right corner.)
- Mini Touch-up Kit (MTUK) included. MTUK includes small touch-up marker and small fill stick.
- Both doors will have a chrome and wood two-tiered rack.
- Racks on doors are 14 3/8" wide.
- Racks on doors are 3" deep.
- Includes two tilt-out trays.
- Tilt-out trays are stain resistant, moisture resistant plastic to allow storage of sponges and other cleaning materials.
- Clean tilt-out trays using a mild soap and water. Avoid scalding water.
- Tilt-out trays are also available as an accessory for field installation. See page 153.
- All load bearing surfaces can support 15 lbs. per square foot.

Custom Modifications

AUTH	CBO	CCO	CFNTO	CFP	CFRMO	CND	FB	FD	FPEB	FTK	FTK_V	MIP	P	RD	RECTKALL/BK	RECTKL/R	RT	VTK
•		•				•	•	•		•	•	•			•		•	•

Construction Upgrades

APW	PLE
•	•

Non Soft-close Options

NSCFB	NSCH
	•

SINK BASE SUPERCABINET™ with TILT-OUT TRAYS and CABMAT™

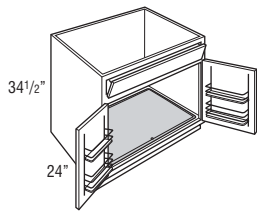

Price Point	1	2	3	4	5	6	7	8	9	10	11
SB36STSCM	1552	1588	1668	1722	1800	1840	1860	1944	1968	2079	2177

- Mini Touch-up Kit (MTUK) included. MTUK includes small touch-up marker and small fill stick.
- CabMat™ is designed to capture spills and is removable for cleaning.
- Both doors will have a chrome and wood two-tiered rack.
- Racks on doors are 14 3/8" wide.
- Racks on doors are 3" deep.
- Includes two tilt-out trays.
- Tilt-out trays are stain resistant, moisture resistant plastic to allow storage of sponges and other cleaning materials.
- Clean tilt-out trays using a mild soap and water. Avoid scalding water.
- Tilt-out trays are also available as an accessory for field installation. See page 153.
- All load bearing surfaces can support 15 lbs. per square foot.
- CabMat™ also available for field installation. See page 151.

Custom Modifications

AUTH	CBO	CCO	CFNTO	CFP	CFRMO	CND	FB	FD	FPEB	FTK	FTK_V	MIP	P	RD	RECTKALL/BK	RECTKL/R	RT	VTK
•	•	•				•	•	•		•	•	•			•		•	•

Construction Upgrades

APW	PLE
•	•

Non Soft-close Options

NSCFB	NSCH
	•

ANGLED CORNER SINK BASE

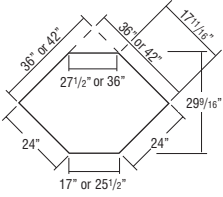
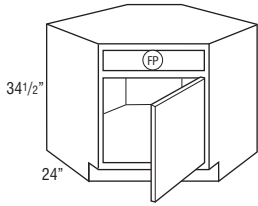

Max. Sink Widths if cut-out is 4" back from face of front frame

FP = False Panel

Price Point

	1	2	3	4	5	6	7	8	9	10	11
ACS36 L or R	502	528	583	621	672	698	712	767	782	851	922
ACS42[†]	553	583	640	685	741	769	783	845	863	937	1015

- Edges beveled at 45°.
- Mini Touch-up Kit (MTUK) included. MTUK includes small touch-up marker and small fill stick.
- For sufficient dishwasher door clearance and loading/unloading space, a 15" wide base cabinet is recommended for use between a corner sink base and dishwasher.
- On ACS36, full overlay styles use the same width doors as partial overlay styles (14 1/2" wide) with a partial overlay hinge (38NPOHINGE) to allow for proper door clearance with adjacent cabinets.

[†]ACS42 has butt doors.

Wall Width	Frame	Maximum Sink Width	Maximum Sink Depth
36" x 36"	17"	25 3/4"	27 11/32"
42" x 42"	25 1/2"	34 1/4"	27 11/32"

Custom Modifications

AUTH	CBO	CCO	CFNTO	CFP	CFRMO	CND	FB	FD	FPEB	FTK	FTK_V	MIP	P	RD	RECTKALL/BK	RECTKL/R	RT	VTK
		•	•	STD		•	•		•									•

Construction Upgrades

APW	PLE
•	•

Non Soft-close Options

NSCFB	NSCH
	•

ANGLED CORNER SINK FRONT without SINK BOTTOM

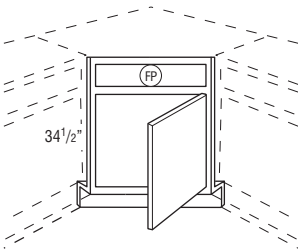

Max. Sink Widths if cut-out is 4" back from face of front frame

FP = False Panel

	1	2	3	4	5	6	7	8	9	10	11
ACSF36 L or R	447	465	500	539	565	577	616	656	695	752	778
ACSF42[†]	502	528	583	621	672	698	712	767	782	851	922

- Edges beveled at 45°.
- Angled corner sink front bottom required for field installation. Order separately. See next item.
- Toekick and toekick return shipped unattached from the face frame.
- On ACSF36, full overlay styles use the same width doors as partial overlay styles (14 1/2" wide) with a partial overlay hinge (38NPOHINGE) to allow for proper door clearance with adjacent cabinets.
- For sufficient dishwasher door clearance and loading/unloading space, a 15" wide base cabinet is recommended for use between a corner sink base and dishwasher.

[†]ACSF42 has butt doors.

Wall Width	Frame	Maximum Sink Width	Maximum Sink Depth
36" x 36"	17"	25 3/4"	27 11/32"
42" x 42"	25 1/2"	34 1/4"	27 11/32"

Custom Modifications

AUTH	CBO	CCO	CFNTO	CFP	CFRMO	CND	FB	FD	FPEB	FTK	FTK_V	MIP	P	RD	RECTKALL/BK	RECTKL/R	RT	VTK
			STD	STD		•	•											

Construction Upgrades

APW	PLE

Non Soft-close Options

NSCFB	NSCH
	•

ANGLED CORNER SINK FRONT BOTTOM

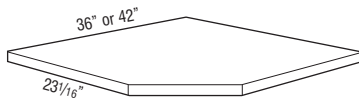

	1	2	3	4	5	6	7	8	9	10	11
ACSF36	140	140	140	140	140	140	140	140	140	140	140
ACSF42	161	161	161	161	161	161	161	161	161	161	161

- Designed for use with Angled Corner Sink Front.
- 3/8" thick.
- Trimmable.
- Cabinet bottom is sized for use next to an adjacent wall or cabinet with flush ends.

MODIFICATIONS

No modifications available for these products.

Construction Upgrades

APW	PLE
•	

COUNTRY SINK BASE

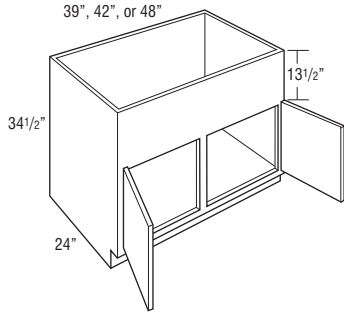
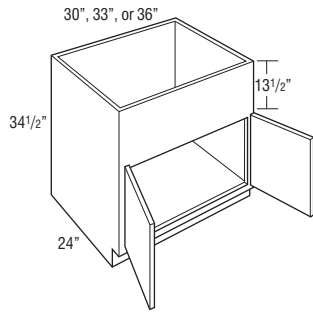

Price Point	1	2	3	4	5	6	7	8	9	10	11
CNTYSB30	776	843	905	957	989	1006	1058	1108	1178	1268	1316
CNTYSB33	799	867	927	984	1021	1039	1095	1150	1221	1321	1368
CNTYSB36	821	891	956	1015	1054	1075	1133	1192	1267	1370	1420
CNTYSB39	891	967	1035	1098	1140	1160	1221	1283	1361	1471	1525
CNTYSB42	945	1025	1097	1163	1207	1229	1296	1361	1445	1562	1617
CNTYSB48CS	1051	1141	1221	1296	1344	1369	1442	1516	1608	1739	1799

- 13 1/2" panel can be trimmed up to 12".
- Mini Touch-up Kit (MTUK) included. MTUK includes small touch-up marker and small fill stick.
- For apron front sinks requiring a cut-out height of 6 1/2" or less, see Base Drop-in Range Cabinets on page 79.
- Refer to sink manufacturer's recommendations for additional support required for apron front sinks.

Custom Modifications

AUTH	CBO	CCO	CFNT0	CFP	CFRMO	CND	FB	FD	FPEB	FTK	FTK_V	MIP	P	RD	RECTKALL/BK	RECTKL/R	RT	VTK
•		•	•		•		•		•	•	•	•		•	•			•

Construction Upgrades

APW	PLE
•	•

Non Soft-close Options

NSCFB	NSCH
	•

COUNTRY SINK BASE with CABMAT™

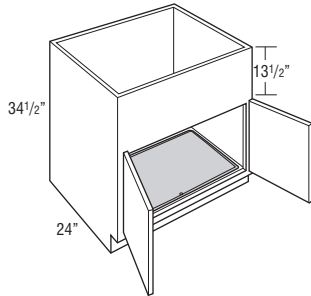

CNTYSB30CM	1076	1143	1205	1257	1289	1306	1358	1408	1478	1568	1616
CNTYSB33CM	1099	1167	1227	1284	1321	1339	1395	1450	1521	1621	1668
CNTYSB36CM	1121	1191	1256	1315	1354	1375	1433	1492	1567	1670	1720

- 13 1/2" panel can be trimmed to 12".
- Mini Touch-up Kit (MTUK) included. MTUK includes small touch-up marker and small fill stick.
- CabMat™ is designed to capture spills and is removable for cleaning.
- For apron front sinks requiring a cut-out height of 6 1/2" or less, see Base Drop-in Range Cabinets on page 79.
- Refer to sink manufacturer's recommendations for additional support required for apron front sinks.
- CabMat™ also available for field installation. See page 151.

Custom Modifications

AUTH	CBO	CCO	CFNT0	CFP	CFRMO	CND	FB	FD	FPEB	FTK	FTK_V	MIP	P	RD	RECTKALL/BK	RECTKL/R	RT	VTK
•	•	•	•		•		•		•	•	•	•		•	•			•

Construction Upgrades

APW	PLE
•	•

Non Soft-close Options

NSCFB	NSCH
	•

**COUNTRY SINK BASE,
27" DEEP**

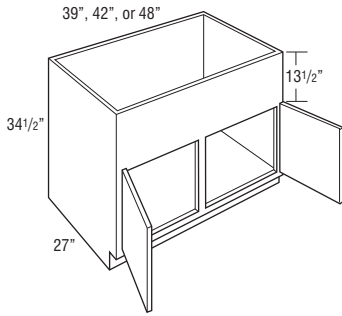
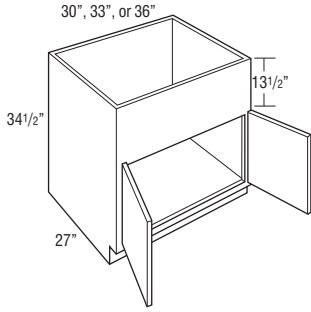

Price Point

	1	2	3	4	5	6	7	8	9	10	11
CNTYSB303427	926	993	1055	1107	1139	1156	1208	1258	1328	1418	1466
CNTYSB333427	949	1017	1077	1134	1171	1189	1245	1300	1371	1471	1518
CNTYSB363427	971	1041	1106	1165	1204	1225	1283	1342	1417	1520	1570

CNTYSB393427	1041	1117	1185	1248	1290	1310	1371	1433	1511	1621	1675
CNTYSB423427	1095	1175	1247	1313	1357	1379	1446	1511	1595	1712	1767
CNTYSB483427CS	1201	1291	1371	1446	1494	1519	1592	1666	1758	1889	1949

- 13 1/2" panel can be trimmed up to 12".
- Mini Touch-up Kit (MTUK) included. MTUK includes small touch-up marker and small fill stick.
- For apron front sinks requiring a cut-out height of 6 1/2" or less, see Base Drop-in Range Cabinets on page 79.
- Refer to sink manufacturer's recommendations for additional support required for apron front sinks.

Custom Modifications

AUTH	CBO	CCO	CFNTO	CFP	CFRMO	CND	FB	FD	FPEB	FTK	FTK_V	MIP	P	RD	RECTKALL/BK	RECTKL/R	RT	VTK	
		•	•			•		•		•	•	•			•		•		•

Construction Upgrades

APW	PLE
•	•

Non Soft-close Options

NSCFB	NSCH
	•

Base Corner Cabinets

- BCs use the wall space the nomenclature implies.
- Remember to use 3" filler on adjoining cabinets.
- The adjoining run of cabinets will cover the void.
- The L or R in the cabinet nomenclature indicates the location of the void to ensure clearance.
- It is not recommended to place BC cabinets next to appliances where any face component is deeper than 27".

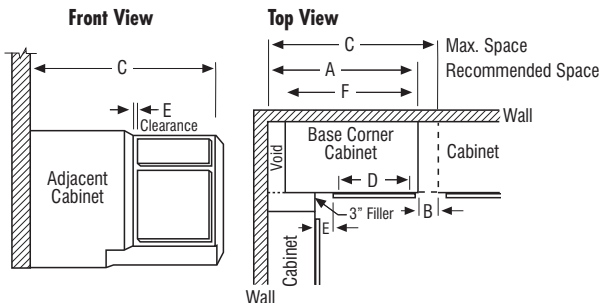

Model	A Recommended Space	B Max. Pull*	C Max. Space	D Face Frame Opening	E* Full Overlay		E* Partial Overlay		F Actual Cabinet	Full Overlay Door Width	Partial Overlay Door Width
					At Min.**	At Max.	At Min.**	At Max.			
BC36	36"	6"	42"	7 1/2"	1 3/4"	7 3/4"	2 1/2"	8 1/2"	27"	10"	8 1/2"
BC39	39"	4 1/2"	43 1/2"	9"	3 1/4"	7 3/4"	4"	8 1/2"	30"	11 1/2"	10"
BC42	42"	6"	48"	13 1/2"	1 3/4"	7 3/4"	2 1/2"	8 1/2"	39"	16"	14 1/2"
BC45	45"	4 1/2"	49 1/2"	15"	3 1/4"	7 3/4"	4"	8 1/2"	42"	17 1/2"	16"
BC48	48"	3"	51"	16 1/2"	4 3/4"	7 3/4"	5 1/2"	8 1/2"	45"	19"	17 1/2"

*Minimum/maximum space between inside edge of door and face of filler/adjoining cabinet. If cabinet is pulled to maximum stated dimension, filler will need to be cleated for proper attachment.
 **When using hardware on cabinet doors/drawers, additional clearance may be needed.

BASE CORNER

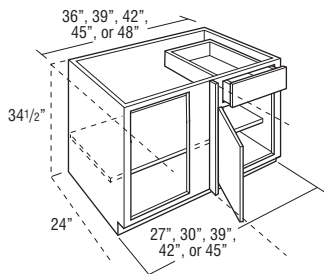

	Price Point											
		1	2	3	4	5	6	7	8	9	10	11
BC36 L or R		653	677	727	762	812	837	846	894	912	969	1028
BC39 L or R		702	727	782	818	874	901	909	961	982	1043	1106
BC42 L or R		753	780	838	879	936	964	974	1030	1051	1117	1184
BC45 L or R		801	832	893	935	996	1026	1036	1097	1119	1189	1263
BC48 L or R		853	883	950	995	1060	1092	1104	1169	1192	1265	1343

- Includes one 3" filler, shipped unattached.
- L or R indicates void. L (left) void shown.
- Adjustable 15" deep shelf.
- On void side, do not install next to an appliance deeper than standard cabinet depth due to clearance needed for the door and drawer.

Custom Modifications

AUTH	CBO	CCO	CFNT0	CFP	CFRMO	CND	FB	FD	FPEB	FTK	FTK_V	MIP	P	RD	RECTKALL/BK	RECTKL/R	RT	VTK
•	•	•	•	•	•	•	•	•	•	•	•	•	•	•	•	•	•	•

Construction Upgrades

APW	PLE
•	•

Non Soft-close Options

NSCFB	NSCH
•	•

BASE LAZY SUSAN CORNER with FULL HEIGHT DOOR and LAZY SUSAN (With Center Hinge Door)

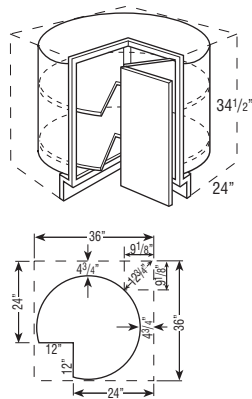

BLS36 L or R	1045	1143	1256	1318	1365	1388	1459	1529	1622	1754	1818
--------------	------	------	------	------	------	------	------	------	------	------	------

- BLS36 L or R wall width is 36" x 36".
- Cabinet is drum-shaped; adjoining cabinets create sides.
- BLS white plastic shelves are 28" diameter with a chrome pole.
- See Panels & Skins section for BLSBEP** if used at end of cabinet run.
- Drum diameter is 31 1/8" and composed of 1/8" thick hardboard.
- Decorative hardware screws must be countersunk to prevent scratching of adjacent cabinets and face frame of BLS.
- Not recommended for use next to an appliance deeper than standard cabinet depth.
- Integrated soft-close hinge not included.

Custom Modifications

AUTH	CBO	CCO	CFNT0	CFP	CFRMO	CND	FB	FD	FPEB	FTK	FTK_V	MIP	P	RD	RECTKALL/BK	RECTKL/R	RT	VTK
•	•	•	•	•	•	•	•	•	•	•	•	•	•	•	•	•	•	•

Construction Upgrades

APW	PLE
•	•

Non Soft-close Options

NSCFB	NSCH
•	•

DIAGONAL BASE with FULL HEIGHT DOOR

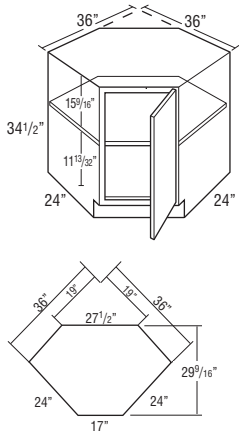

Price Point	1	2	3	4	5	6	7	8	9	10	11
DAB36FS L or R	670	706	777	830	898	930	948	1022	1043	1135	1229

- One fixed 1/2" thick shelf.
- Full overlay styles use the same width doors as partial overlay styles (14 1/2" wide) with a partial overlay hinge (38NPOHINGE) to allow for proper door clearance with adjacent cabinets.

Custom Modifications

AUTH	CBO	CCO	CFNTD	CFP	CFRMO	CND	FB	FD	FPEB	FTK	FTK_V	MIP	P	RD	RECTKALL/BK	RECTKL/R	RT	VTK	
		•																	•

Construction Upgrades

APW	PLE
•	•

Non Soft-close Options

NSCFB	NSCH
	•

DIAGONAL BASE with FULL HEIGHT DOOR & SUPER LAZY SUSAN

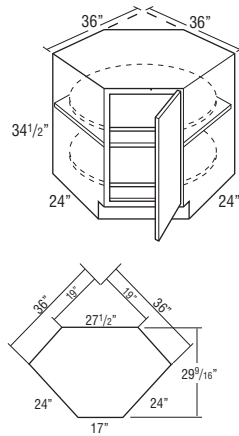

DAB36SLS L or R	1538	1574	1645	1698	1766	1798	1816	1890	1911	2003	2097
------------------------	------	------	------	------	------	------	------	------	------	------	------

- Features two 28" diameter D-shaped plywood revolving shelves with a 1" plywood lip. Lower shelf is mounted to floor. Upper shelf is mounted to fixed shelf. Fixed shelf is 1/2" thick laminated furniture board.
- Full overlay styles use the same width doors as partial overlay styles (14 1/2" wide) with a partial overlay hinge (38NPOHINGE) to allow for proper door clearance with adjacent cabinets.

Custom Modifications

AUTH	CBO	CCO	CFNTD	CFP	CFRMO	CND	FB	FD	FPEB	FTK	FTK_V	MIP	P	RD	RECTKALL/BK	RECTKL/R	RT	VTK	
		•																	•

Construction Upgrades

APW	PLE
•	•

Non Soft-close Options

NSCFB	NSCH
	•

Due to fixed shelf mounting, shelves cannot be retrofitted.

BASE EASY REACH

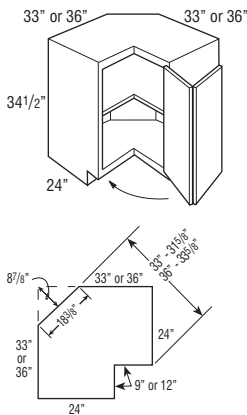

BER33 L or R	838	882	972	1038	1120	1162	1187	1281	1306	1418	1537
BER36 L or R	838	882	972	1038	1120	1162	1187	1281	1306	1418	1537

- BER33 L or R wall width is 33" x 33". BER36 L or R wall width is 36" x 36".
- Decorative hardware screws must be countersunk to prevent scratching of adjacent cabinets and face frame of BER.
- Fixed shelf is 1/2" thick laminated furniture board.
- Not recommended for use next to an appliance deeper than standard cabinet depth.
- Integrated soft-close hinge not included.

Custom Modifications

AUTH	CBO	CCO	CFNTD	CFP	CFRMO	CND	FB	FD	FPEB	FTK	FTK_V	MIP	P	RD	RECTKALL/BK	RECTKL/R	RT	VTK	
		•																	•

Construction Upgrades

APW	PLE
•	•

Non Soft-close Options

NSCFB	NSCH
	STD

ASYMMETRICAL BASE EASY REACH

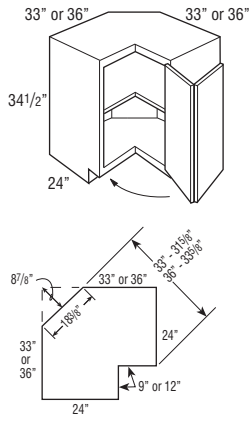

Price Point	1	2	3	4	5	6	7	8	9	10	11
BER3336 L or R	838	882	972	1038	1120	1162	1187	1281	1306	1418	1537
BER3633 L or R	838	882	972	1038	1120	1162	1187	1281	1306	1418	1537

- BER3336 L or R wall width is 33" x 36".
- BER3633 L or R wall width is 36" x 33".
- Legs at the front frames are 9" on 33" and 12" on 36" leg.
- Nomenclature for asymmetrical cabinets reads as follows:
First set of numbers = left side of cabinet dimensions.
Second set of numbers = right side of cabinet dimensions.
- Decorative hardware screws must be countersunk to prevent scratching of adjacent cabinets and face frame of BER.
- Fixed shelf is 1/2" thick laminated furniture board.
- Not recommended for use next to an appliance deeper than standard cabinet depth.
- Integrated soft-close hinge not included.

Custom Modifications

AUTH	CBO	CCO	CFNTO	CFP	CFRMO	CND	FB	FD	FPEB	FTK	FTK_V	MIP	P	RD	RECTKALL/BK	RECTKL/R	RT	VTK
	•	•					•	•										•

Construction Upgrades

APW	PLE
•	•

Non Soft-close Options

NSCFB	NSCH
	STD

SUPER LAZY SUSAN

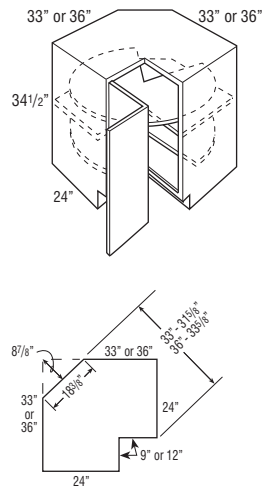

SLS33 L or R	1863	2061	2209	2252	2344	2389	2413	2506	2531	2646	2764
SLS36 L or R	1956	2122	2209	2252	2344	2389	2413	2506	2531	2646	2764

- SLS33 L or R wall width is 33" x 33".
- SLS36 L or R wall width is 36" x 36".
- SLS33 - Susans are 28" diameter.
- SLS36 - Susans are 32" diameter.
- Features two plywood revolving shelves with a 1" plywood lip. Lower shelf is mounted to floor. Upper shelf is mounted to fixed shelf. Fixed shelf is 1/2" thick laminated furniture board.
- Decorative hardware screws must be countersunk to prevent scratching adjacent cabinets and face frame of SLS.
- Not recommended for use next to an appliance deeper than standard cabinet depth.
- Integrated soft-close hinge not included.

Custom Modifications

AUTH	CBO	CCO	CFNTO	CFP	CFRMO	CND	FB	FD	FPEB	FTK	FTK_V	MIP	P	RD	RECTKALL/BK	RECTKL/R	RT	VTK
	•						•	•										•

Construction Upgrades

APW	PLE
•	•

Non Soft-close Options

NSCFB	NSCH
	STD

Due to fixed shelf mounting, shelves cannot be retrofitted.

ASYMMETRICAL SUPER LAZY SUSAN

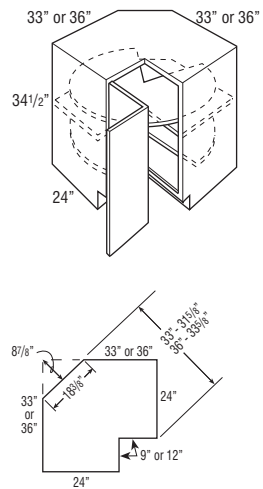

SLS3336 L or R	1956	2122	2209	2252	2344	2389	2413	2506	2531	2646	2764
SLS3633 L or R	1956	2122	2209	2252	2344	2389	2413	2506	2531	2646	2764

- SLS3336 L or R wall width is 33" x 36".
- SLS3633 L or R wall width is 36" x 33".
- All Asymmetrical Super Susan shelves are 28" diameter.
- Features two plywood revolving shelves with a 1" plywood lip. Lower shelf is mounted to floor. Upper shelf is mounted to fixed shelf. Fixed shelf is 1/2" thick laminated furniture board.
- Nomenclature for asymmetrical cabinets reads as follows:
First set of numbers = left side of cabinet dimensions.
Second set of numbers = right side of cabinet dimensions.
- Decorative hardware screws must be countersunk to prevent scratching adjacent cabinets and face frame of SLS.
- Not recommended for use next to an appliance deeper than standard cabinet depth.
- Integrated soft-close hinge not included.

Custom Modifications

AUTH	CBO	CCO	CFNTO	CFP	CFRMO	CND	FB	FD	FPEB	FTK	FTK_V	MIP	P	RD	RECTKALL/BK	RECTKL/R	RT	VTK
	•						•	•										•

Construction Upgrades

APW	PLE
•	•

Non Soft-close Options

NSCFB	NSCH
	STD

Due to fixed shelf mounting, shelves cannot be retrofitted.

BASE TRANSITION CABINET

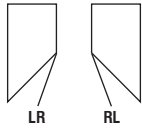
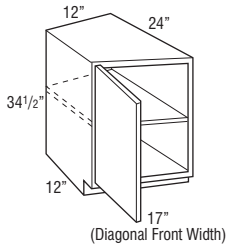

Hinging Options

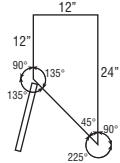

Top View

Price Point

	1	2	3	4	5	6	7	8	9	10	11
BTC12RL	549	580	636	681	737	764	778	827	855	933	980
BTC12LR	549	580	636	681	737	764	778	827	855	933	980

- One adjustable shelf.
- Cabinets constructed with top.
- Door hinged on shallow depth side.
- Reduced Depth to 18" available.
- Full overlay styles use the same width doors as partial overlay styles (14 1/2" wide) with a partial overlay hinge (38NPOHINGE) to allow for proper door clearance with adjacent cabinets.

Custom Modifications

AUTH	CBO	CCO	CFNTO	CFP	CFRMO	CND	FB	FD	FPEB	FTK	FTK_V	MIP	P	RD	RECTKALL/BK	RECTKL/R	RT	VTK
• ¹	•	•	•		•		•		•	•		•		•		• ¹		•

Construction Upgrades

APW	PLE
•	•

Non Soft-close Options

NSCFB	NSCH
	•

¹ Only available on the shallow depth side

BASE END CABINET

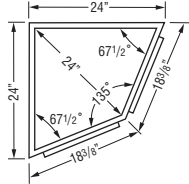
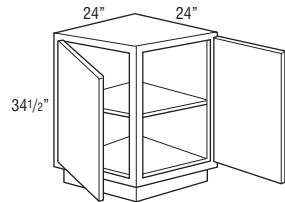

Top View

BEC24	855	899	987	1057	1143	1185	1206	1302	1329	1446	1566
--------------	-----	-----	-----	------	------	------	------	------	------	------	------

- Wall width is 24" x 24".
- 24" W x 24" D x 34 1/2" H.
- 24" from outside corner point to frame face.
- Cabinets constructed with top.
- One adjustable shelf.
- Cabinet may be installed against either end of a run.

Custom Modifications

AUTH	CBO	CCO	CFNTO	CFP	CFRMO	CND	FB	FD	FPEB	FTK	FTK_V	MIP	P	RD	RECTKALL/BK	RECTKL/R	RT	VTK
	•	•										•						•

Construction Upgrades

APW	PLE
•	

Non Soft-close Options

NSCFB	NSCH
	•

TWO DRAWER BASE

18", 21", 24", 27", 30", 33" or 36"

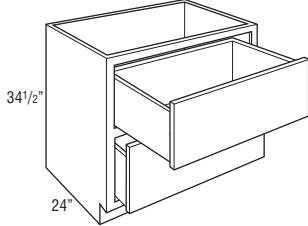

2DB18	1226	1250	1312	1343	1369	1381	1404	1426	1517	1584	1649
2DB21	1248	1273	1336	1368	1428	1458	1472	1528	1544	1614	1679
2DB24	1273	1299	1362	1395	1458	1487	1501	1558	1575	1647	1713
2DB27	1538	1556	1592	1665	1732	1766	1837	1909	1927	2014	2096
2DB30	1852	1864	1873	1987	2064	2102	2230	2318	2340	2445	2545
2DB33	1896	1911	1920	2048	2133	2176	2267	2355	2378	2486	2587
2DB36	1939	1957	1967	2107	2201	2248	2303	2392	2416	2525	2627

- Exterior drawer box height is 10".

Custom Modifications

AUTH	CBO	CCO	CFNTO	CFP	CFRMO	CND	FB	FD	FPEB	FTK	FTK_V	MIP	P	RD	RECTKALL/BK	RECTKL/R	RT	VTK
•	•	•			•		•		•	•		•		•	• ¹	•		•

Construction Upgrades

APW	PLE
•	•

Non Soft-close Options

NSCFB	NSCH

¹ RECTKALL not available on 18", 21" or 24" wide

TWO DRAWER BASE with ROLL TRAY

24", 30", or 36"

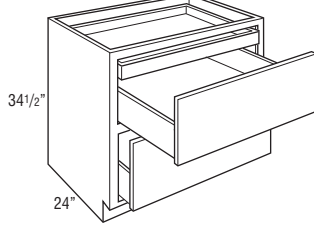

Price Point	1	2	3	4	5	6	7	8	9	10	11
2DB24RT	1318	1344	1413	1446	1509	1540	1556	1616	1632	1706	1775
2DB30RT	2002	2043	2113	2197	2291	2338	2363	2456	2480	2591	2696
2DB36RT	2053	2097	2202	2254	2352	2401	2426	2519	2545	2659	2768

• Exterior drawer box height is 6 3/8".

Custom Modifications

AUTH	CBO	CCO	CFNTD	CFP	CFRMO	CND	FB	FD	FPEB	FTK	FTK_V	MIP	P	RD	RECTKALL/BK	RECTKL/R	RT	VTK
•	•	•			•		•		•	•	•				• ¹	•		•

Construction Upgrades

APW	PLE
•	•

Non Soft-close Options

NSCFB	NSCH

¹ RECTKALL not available on 24" wide

TWO DRAWER BASE, DROP-IN RANGE

36"

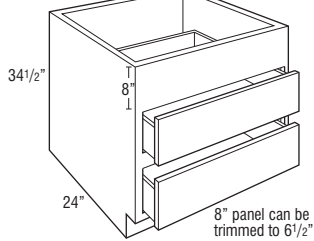

2DB36DR	2227	2234	2245	2408	2516	2570	2731	2835	2864	2993	3115
----------------	------	------	------	------	------	------	------	------	------	------	------

• Exterior height of drawer boxes is 6 3/8".

Custom Modifications

AUTH	CBO	CCO	CFNTD	CFP	CFRMO	CND	FB	FD	FPEB	FTK	FTK_V	MIP	P	RD	RECTKALL/BK	RECTKL/R	RT	VTK
•	•	•			•		•		•	•	•				•	•		•

Construction Upgrades

APW	PLE
•	•

Non Soft-close Options

NSCFB	NSCH

THREE DRAWER BASE

12", 15", 18", or 21"

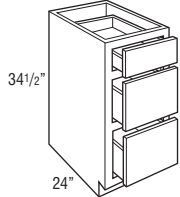

24", 27", 30", 33", or 36"

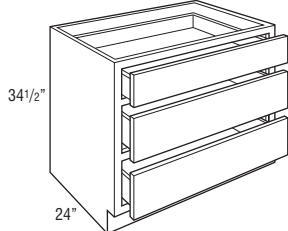

3DB12	707	726	769	795	840	864	866	907	926	967	1014
3DB15	761	781	828	856	904	929	932	975	995	1041	1090
3DB18	815	836	886	917	969	995	1000	1044	1066	1114	1169
3DB21	875	899	952	984	1040	1068	1071	1122	1145	1198	1255

3DB24	932	958	1015	1049	1109	1138	1143	1197	1221	1276	1338
3DB27	1210	1237	1306	1343	1416	1452	1455	1517	1548	1610	1682
3DB30	1495	1530	1614	1661	1751	1795	1797	1874	1912	1988	2077
3DB33	1546	1582	1669	1717	1809	1855	1860	1939	1978	2058	2149
3DB36	1593	1631	1721	1771	1866	1913	1917	1997	2038	2121	2215

• Exterior height of bottom 2 drawer boxes is 6 3/8".

Custom Modifications

AUTH	CBO	CCO	CFNTD	CFP	CFRMO	CND	FB	FD	FPEB	FTK	FTK_V	MIP	P	RD	RECTKALL/BK	RECTKL/R	RT	VTK
•	•	•			•		•		•	•	•				• ¹	•		•

Construction Upgrades

APW	PLE
•	•

Non Soft-close Options

NSCFB	NSCH
• ²	

¹ RECTKALL not available on 12", 15", 18", 21" or 24" wide

² Not available on 30", 33", or 36" wide

THREE DRAWER BASE with WOOD TIERED CUTLERY DIVIDER DRAWER

15", 18", 21", or 24"

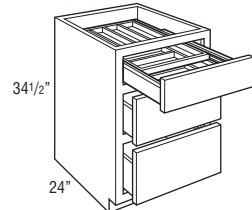

3DB15WTC	1273	1293	1340	1368	1416	1441	1444	1487	1507	1553	1602
3DB18WTC	1347	1368	1418	1449	1501	1527	1532	1576	1598	1646	1701
3DB21WTC	1429	1453	1506	1538	1594	1622	1625	1676	1699	1752	1809
3DB24WTC	1503	1529	1586	1620	1680	1709	1714	1768	1792	1847	1909

• Includes Wood Tiered Cutlery Divider Drawer in top drawer.

• Exterior height for lower drawer boxes is 6 3/8".

• Exterior WTC drawer box height is 3 3/4", interior height of top and bottom tier is 1 3/8".

• Wood Tiered Cutlery Divider Drawer is also available as an accessory. See page 152.

Custom Modifications

AUTH	CBO	CCO	CFNTD	CFP	CFRMO	CND	FB	FD	FPEB	FTK	FTK_V	MIP	P	RD	RECTKALL/BK	RECTKL/R	RT	VTK
•	•	•			•		•		•	•	•				• ¹	•		•

Construction Upgrades

APW	PLE
•	•

Non Soft-close Options

NSCFB	NSCH

¹ RECTKALL not available

FOUR DRAWER BASE

12", 15", 18", or 21"

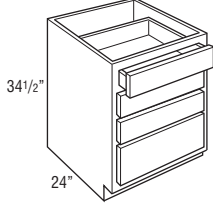

24", 27", or 30"

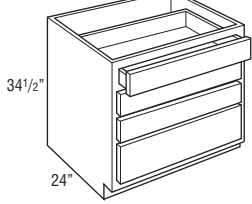

Price Point

	1	2	3	4	5	6	7	8	9	10	11
4DB12	752	772	819	846	894	919	922	965	985	1028	1079
4DB15	812	834	883	913	966	992	995	1042	1063	1110	1165
4DB18	874	898	951	983	1039	1066	1070	1120	1143	1196	1254
4DB21	932	957	1014	1048	1107	1136	1141	1196	1220	1275	1336

4DB24	1001	1029	1090	1125	1190	1222	1226	1284	1310	1370	1437
4DB27	1250	1286	1362	1406	1488	1528	1533	1605	1637	1713	1797
4DB30	1376	1415	1499	1547	1637	1680	1686	1766	1800	1884	1976

• Exterior height of bottom drawer box is 6 3/8".

Custom Modifications

AUTH	CBO	CCO	CFNT0	CFP	CFRMO	CND	FB	FD	FPEB	FTK	FTK_V	MIP	P	RD	RECTKALL/BK	RECTKL/R	RT	VTK
•	•	•		•	•		•		•	•	• ¹			•	• ²	•		•

Construction Upgrades

APW	PLE
•	•

Non Soft-close Options

NSCFB	NSCH
•	

¹ Not available on 12" wide

² RECTKALL not available on 12", 15", 18", 21" or 24" wide

FOUR DRAWER BASE with WOOD TIERED CUTLERY DIVIDER DRAWER

15", 18", 21", or 24"

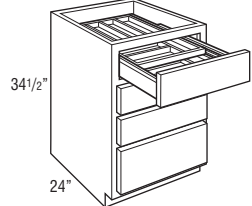

4DB15WTC	1324	1346	1395	1425	1478	1504	1507	1554	1575	1622	1677
4DB18WTC	1406	1430	1483	1515	1571	1598	1602	1652	1675	1728	1786
4DB21WTC	1486	1511	1568	1602	1661	1690	1695	1750	1774	1829	1890
4DB24WTC	1572	1600	1661	1696	1761	1793	1797	1855	1881	1941	2008

- Includes Wood Tiered Cutlery Divider Drawer in top drawer.
- Exterior WTC drawer box height is 3 3/4", interior height of top and bottom tier is 1 3/8".
- Exterior height of bottom drawer box is 6 3/8".
- Wood Tiered Cutlery Divider Drawer is also available as an accessory. See page 152.

Custom Modifications

AUTH	CBO	CCO	CFNT0	CFP	CFRMO	CND	FB	FD	FPEB	FTK	FTK_V	MIP	P	RD	RECTKALL/BK	RECTKL/R	RT	VTK
•	•	•			•		•		•	•	•				• ¹	•		•

Construction Upgrades

APW	PLE
•	•

Non Soft-close Options

NSCFB	NSCH

¹ RECTKALL not available

BASE WASTEBASKET

15"

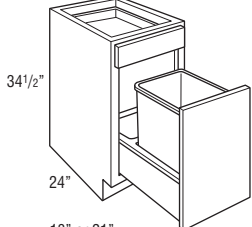

18" or 21"

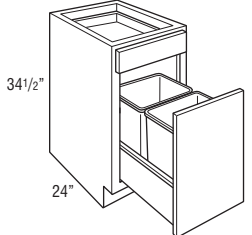

BWB15	1047	1069	1122	1155	1219	1250	1256	1314	1341	1406	1481
BWB18	1079	1100	1164	1200	1264	1295	1301	1366	1394	1464	1544
BWB21	1118	1144	1208	1245	1316	1352	1358	1426	1455	1527	1612

- Pull-out features undermount soft-close guides.
- BWB15 includes one 35 quart gray wastebasket and a trash bag storage area.
- BWB18 and BWB21 include two 35 quart gray wastebaskets.

Custom Modifications

AUTH	CBO	CCO	CFNT0	CFP	CFRMO	CND	FB	FD	FPEB	FTK	FTK_V	MIP	P	RD	RECTKALL/BK	RECTKL/R	RT	VTK
•	•	•		•	•		•		•	•	•				• ¹	•		•

Construction Upgrades

APW	PLE
•	•

Non Soft-close Options

NSCFB	NSCH

¹ RECTKALL not available

BASE WASTEBASKET FULL HEIGHT

	Price Point	1	2	3	4	5	6	7	8	9	10	11
BWB15FH		1000	1016	1070	1098	1156	1185	1189	1241	1267	1327	1395
BWB18FH2		1028	1048	1104	1136	1198	1228	1230	1288	1314	1377	1450
BWB21FH		1062	1085	1144	1178	1245	1277	1283	1342	1369	1436	1514

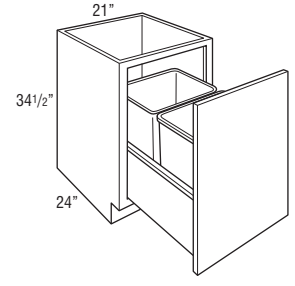
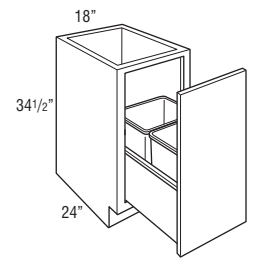
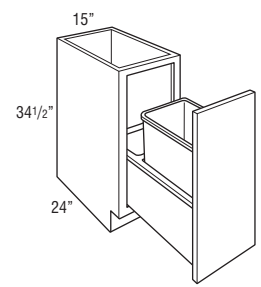

- Pull-out features undermount soft-close guides.
- BWB15FH includes one 50 quart gray wastebasket and a trash bag storage area.
- BWB18FH2 includes two 35 quart gray wastebaskets.
- BWB21FH includes two 50 quart gray wastebaskets.

Custom Modifications

AUTH	CBO	CCO	CFNT0	CFP	CFRMO	CND	FB	FD	FPEB	FTK	FTK_V	MIP	P	RD	RECTKALL/BK	RECTKL/R	RT	VTK
•	•	•			•		•		•	•	•				• ¹	•		•

Construction Upgrades

APW	PLE
•	•

Non Soft-close Options

NSCFB	NSCH

¹ RECTKALL not available

BASE WINE CUBBY

BWC634.5	1100	1100	1100	1100	1100	1100	1100	1100	1100	1100	1100	1100
-----------------	------	------	------	------	------	------	------	------	------	------	------	------

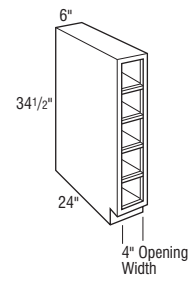

- Vertical application only.
- Reduced Depth only available in 3" increments down to 12".

Custom Modifications

AUTH	CBO	CCO	CFNT0	CFP	CFRMO	CND	FB	FD	FPEB	FTK	FTK_V	MIP	P	RD	RECTKALL/BK	RECTKL/R	RT	VTK
					•				•	•		STD		•				•

Construction Upgrades

APW	PLE
•	

Non Soft-close Options

NSCFB	NSCH

BASE PANTRY PULL-OUT

BPP9	1172	1243	1255	1285	1304	1314	1342	1371	1443	1543	1585
BPP12	1252	1321	1340	1372	1394	1405	1437	1469	1543	1650	1702

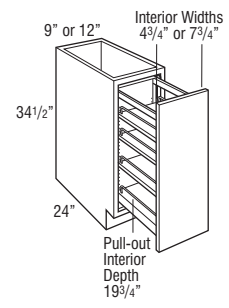

- All styles feature a natural finish soft-close wood pull-out with adjustable shelves and chrome rail sides. The adjustable rear wall of the pull-out prevents items from falling behind the unit.

Custom Modifications

AUTH	CBO	CCO	CFNT0	CFP	CFRMO	CND	FB	FD	FPEB	FTK	FTK_V	MIP	P	RD	RECTKALL/BK	RECTKL/R	RT	VTK
•	•	•			•		•		•	•	•				• ¹	•		•

Construction Upgrades

APW	PLE
•	•

Non Soft-close Options

NSCFB	NSCH

¹ RECTKALL not available

BASE UTENSIL PANTRY PULL-OUT

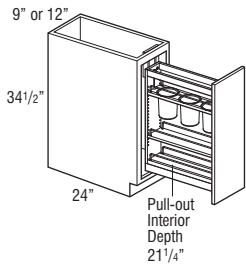

Price Point	1	2	3	4	5	6	7	8	9	10	11
BUPP9	1564	1635	1647	1676	1695	1705	1734	1763	1835	1934	1977
BUPP12	1642	1712	1732	1764	1786	1796	1828	1861	1934	2041	2094

- All styles feature a natural finish soft-close wood pull-out with two adjustable shelves (including canister shelf) and one fixed shelf with chrome rail sides. Top adjustable shelf features three stainless steel canisters for utensils. The adjustable rear wall of the pull-out prevents items from falling behind the unit.
- BUPP9 canisters are 5.85" tall and have an inside diameter of 4.3".
- BUPP12 canisters are 6.7" tall and have an inside diameter of 5".

Custom Modifications

AUTH	CBO	CCO	CFNT0	CFP	CFRMO	CND	FB	FD	FPEB	FTK	FTK_V	MIP	P	RD	RECTKALL/BK	RECTKL/R	RT	VTK
•	•	•			•		•		•	•					• ¹	•		•

Construction Upgrades

APW	PLE
•	•

Non Soft-close Options

NSCFB	NSCH

¹ RECTKALL not available

BASE UTENSIL PANTRY PULL-OUT with KNIFE BLOCK

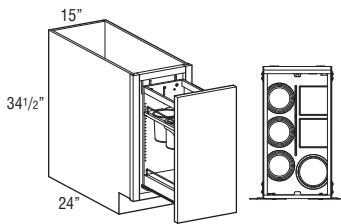
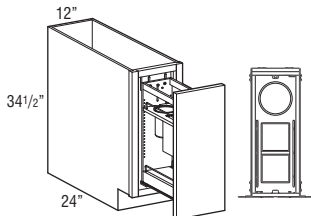

BUPPKB12	2550	2588	2711	2772	2830	2858	2889	2921	2994	3103	3154
BUPPKB15	2975	3009	3132	3185	3225	3245	3278	3310	3383	3490	3543

- Full extension, soft-close wood pull-out with natural finish and one fixed shelf.
- BUPPKB12 features an adjustable shelf with two knife blocks, one stainless steel canister, four cutting boards, and one fixed shelf with chrome rails. Canister is 6.7" tall and has an inside diameter of 5".
- BUPPKB15 features an adjustable shelf with two knife blocks, four stainless steel canisters, four cutting boards, and one fixed shelf with chrome rails. Three canisters are 5.85" tall and have an inside diameter of 4.3", and one is 6.7" tall with an inside diameter of 5".
- Knife block features movable flex rods that adjust to hold a multitude of knives.
- Includes adjustable rear wall for extra strength and stability.
- Adjustable shelf is easily reversible for placement of knife blocks in the front or rear.

Custom Modifications

AUTH	CBO	CCO	CFNT0	CFP	CFRMO	CND	FB	FD	FPEB	FTK	FTK_V	MIP	P	RD	RECTKALL/BK	RECTKL/R	RT	VTK
•	•	•			•		•		•	•	• ¹				• ²	•		•

Construction Upgrades

APW	PLE
•	•

Non Soft-close Options

NSCFB	NSCH

¹ Not available on 12" wide

² RECTKALL not available

BASE BOX COLUMN PULL-OUT

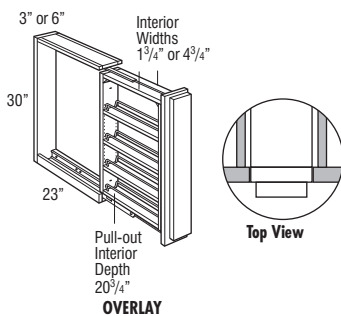
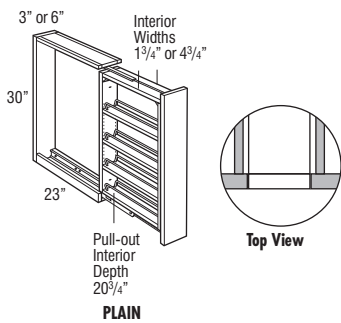

BBCPO3 (Plain)	1213	1213	1213	1213	1213	1213	1213	1213	1213	1213	1213
BBCPO6 (Plain)	1424	1424	1424	1424	1424	1424	1424	1424	1424	1424	1424

BBCPO30L (Overlay)	1268	1268	1268	1268	1268	1268	1268	1268	1268	1268	1268
BBCPO60L (Overlay)	1487	1487	1487	1487	1487	1487	1487	1487	1487	1487	1487

- Recommend installation between two cabinets. If installed on the end of a run or adjacent to an appliance, must use a 3/4" thick end panel.
- Install unit before removing shipping brace and attaching filler.
- Includes unattached profiled full overlay filler on the Overlay SKUs.
- Certain door style overlays will be painted hardwood. See Door Style section for exceptions.
- Decorative hardware required on base units.
- Toekick not included; must be built up in the field.
- All styles feature a natural finish soft-close wood pull-out with adjustable shelves and chrome rail sides.
- In order to allow proper clearance for opening and closing, allow an additional 1/8" space between adjacent cabinet face frames. The 3" wide pull-outs require 3 1/8" space and the 6" wide pull-outs require 6 1/8" space. Spacers are included with the pull-outs to allow for proper installation.
- For full access from both sides of unit, do not install against a wall or next to deeper appliances and cabinets.

MODIFICATIONS

No modifications available for these products.

Price Point	1	2	3	4	5	6	7	8	9	10	11
-------------	---	---	---	---	---	---	---	---	---	----	----

BASE DROP-IN RANGE CABINET

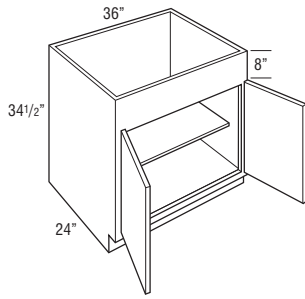

B36DR	821	891	956	1015	1054	1075	1133	1192	1267	1370	1420
--------------	-----	-----	-----	------	------	------	------	------	------	------	------

- 8" panel can be trimmed up to 6 1/2".
- Adjustable 15" deep shelf.
- Can also be used with apron front sinks, refer to manufacturer's dimension requirements.

Custom Modifications

AUTH	CBO	CCO	CFNT0	CFP	CFRMO	CND	FB	FD	FPEB	FTK	FTK_V	MIP	P	RD	RECTKALL/BK	RECTKL/R	RT	VTK
•	•	•	•	•	•	•	•	•	•	•	•	•	•	•	•	•	•	•

Construction Upgrades

APW	PLE
•	•

Non Soft-close Options

NSCFB	NSCH
	•

BASE OVEN CABINET

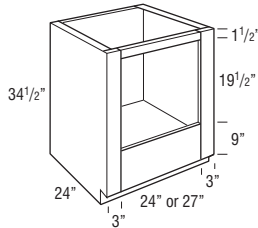

Model	Opening Width	Maximum Width	Opening Height	Maximum Height*
B030	24"	28 1/2"	19 1/2"	27 1/2"
B033	27"	31 1/2"	19 1/2"	27 1/2"
B036	30"	34 1/2"	19 1/2"	27 1/2"

*Top frame cross rail can be removed during field installation if cabinet is properly installed between two adjacent cabinets, increasing the maximum height to 28 1/4".

B030	938	938	938	938	938	938	938	938	938	938	938
-------------	-----	-----	-----	-----	-----	-----	-----	-----	-----	-----	-----

B033	976	976	976	976	976	976	976	976	976	976	976
-------------	-----	-----	-----	-----	-----	-----	-----	-----	-----	-----	-----

B036	1025	1025	1025	1025	1025	1025	1025	1025	1025	1025	1025
-------------	------	------	------	------	------	------	------	------	------	------	------

- Oven cabinet has laminated interior.
- May not hold cooktop and slide-in oven combination. Refer to cooktop and slide-in oven manufacturer specifications.
- For built in appliance support, OCINSTALLKIT is included in 24" deep cabinets (see page 152 for details), but will not be included when depth is modified.
- OCINSTALLKIT weight limit is 400 lbs. per pair.
- Heat shields are sold separately, as an accessory. See page 152.

Custom Modifications

AUTH	CBO	CCO	CFNT0	CFP	CFRMO	CND	FB	FD	FPEB	FTK	FTK_V	MIP	P	RD	RECTKALL/BK	RECTKL/R	RT	VTK
•					•		•		•	•	•			•	•			•

Construction Upgrades

APW	PLE
•	•

Non Soft-close Options

NSCFB	NSCH

BASE BUILT-IN MICROWAVE CABINET with DRAWER

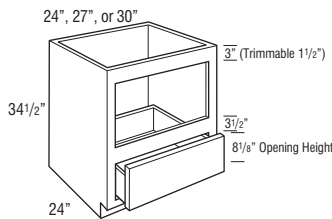

Model	Opening Width	Maximum Width	Opening Height	Maximum Height
BBMWD24	21"	22 1/2"	13 7/8"	16 7/8"
BBMWD27	24"	25 1/2"	13 7/8"	16 7/8"
BBMWD30	27"	28 1/2"	13 7/8"	16 7/8"

BBMWD24	1078	1131	1240	1319	1367	1392	1399	1407	1436	1548	1598
----------------	------	------	------	------	------	------	------	------	------	------	------

BBMWD27	1089	1143	1254	1330	1437	1490	1515	1628	1661	1842	1906
----------------	------	------	------	------	------	------	------	------	------	------	------

BBMWD30	1100	1153	1264	1340	1448	1501	1526	1638	1672	1853	1917
----------------	------	------	------	------	------	------	------	------	------	------	------

- Standard interior.
- For built-in appliance support, OCINSTALLKIT is included in 24" deep cabinets (see page 152 for details), but will not be included when depth is modified.
- OCINSTALLKIT weight limit is 400 lbs. per pair.
- The usable cabinet face height between top of drawer front and top of cabinet is 19 1/8" for partial overlay and 19 3/4" for full overlay. Be sure to verify overall appliance height, gap requirements, and cut-out dimensions with cabinet specifications.

Custom Modifications

AUTH	CBO	CCO	CFNT0	CFP	CFRMO	CND	FB	FD	FPEB	FTK	FTK_V	MIP	P	RD	RECTKALL/BK	RECTKL/R	RT	VTK
•	•	•			•				•	•	•			•	• ¹			•

Construction Upgrades

APW	PLE
•	•

Non Soft-close Options

NSCFB	NSCH

¹ RECTKALL not available on 24" wide

BASE MICROWAVE CABINET with DRAWER

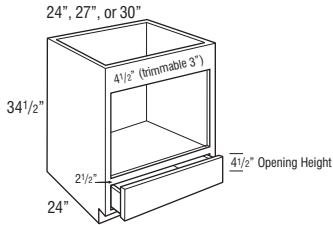

Model	Opening Width	Maximum Width	Opening Height	Maximum Height
BMWD24	21"	22 1/2"	17"	20"
BMWD27	24"	25 1/2"	17"	20"
BMWD30	27"	28 1/2"	17"	20"

	Price Point	1	2	3	4	5	6	7	8	9	10	11
BMWD24		949	998	1098	1174	1269	1316	1343	1446	1476	1630	1682
BMWD27		994	1045	1150	1227	1330	1380	1406	1516	1547	1771	1826
BMWD30		1033	1086	1197	1275	1381	1434	1460	1572	1604	1841	1897

- Reinforced plywood floor.
- The usable cabinet face height between top of drawer front and top of cabinet is 23 1/2" for partial overlay and full overlay. Be sure to verify overall appliance height, gap requirements, and cut-out dimensions with cabinet specifications.

Custom Modifications

AUTH	CBO	CCO	CFNTO	CFP	CFRMO	CND	FB	FD	FPEB	FTK	FTK_V	MIP	P	RD	RECTKALL/BK	RECTKL/R	RT	VTK
•	•	•				•			•	•	•	STD		•	• ¹	•		•

Construction Upgrades

APW	PLE

Non Soft-dose Options

NSCFB	NSCH
•	

¹ RECTKALL not available on 24" wide

BASE MICROWAVE CABINET with DEEP DRAWER

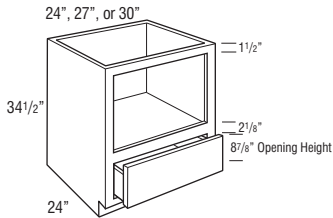

Model	Opening Width	Maximum Width	Opening Height	Maximum Height
BMWD24DD	21"	22 1/2"	16"	16"
BMWD27DD	24"	25 1/2"	16"	16"
BMWD30DD	27"	28 1/2"	16"	16"

	Price Point	1	2	3	4	5	6	7	8	9	10	11
BMWD24DD		949	998	1098	1174	1269	1316	1343	1446	1476	1630	1682
BMWD27DD		994	1045	1150	1227	1330	1380	1406	1516	1547	1771	1826
BMWD30DD		1100	1153	1264	1340	1448	1501	1526	1638	1672	1907	1965

- Reinforced plywood floor.
- The usable cabinet face height between top of drawer front and top of cabinet is 19 1/8" for partial overlay and 18 3/8" for full overlay. Be sure to verify overall appliance height, gap requirements, and cut-out dimensions with cabinet specifications.
- RECTKALL not available on BMWD24DD.

Custom Modifications

AUTH	CBO	CCO	CFNTO	CFP	CFRMO	CND	FB	FD	FPEB	FTK	FTK_V	MIP	P	RD	RECTKALL/BK	RECTKL/R	RT	VTK
•	•	•				•			•	•	•	STD		•	• ¹	•		•

Construction Upgrades

APW	PLE

Non Soft-dose Options

NSCFB	NSCH

¹ RECTKALL not available on 24" wide

BASE CORNER PENINSULA

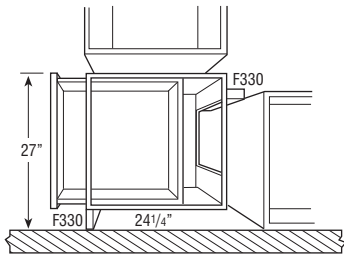

	Price Point	1	2	3	4	5	6	7	8	9	10	11
BCP24		868	913	1002	1072	1157	1200	1226	1321	1348	1469	1590

- Cabinet width is 24".
- Adjustable full depth shelf.
- Includes two 3" fillers, shipped unattached. Fillers are required for drawer and door opening clearance of adjacent cabinets.
- Unfinished toekick on front and back of cabinet.
- Will not accept roll trays.
- Peninsula base cabinets are 1/4" deeper to allow back paneling application on adjacent cabinets in a run with standard 24" deep cabinets.

Custom Modifications

AUTH	CBO	CCO	CFNTO	CFP	CFRMO	CND	FB	FD	FPEB	FTK	FTK_V	MIP	P	RD	RECTKALL/BK	RECTKL/R	RT	VTK
•	•	•				•			•	•	•	STD		•	STD ¹	•		•

Construction Upgrades

APW	PLE
•	•

Non Soft-dose Options

NSCFB	NSCH
•	•

¹ RECTKBK is standard. RECTKALL is not available.

BASE CORNER PENINSULA with FULL HEIGHT DOOR

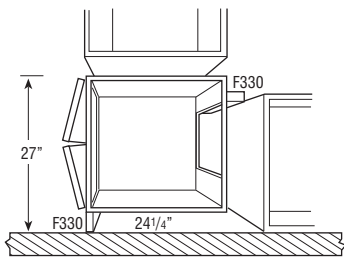

	Price Point	1	2	3	4	5	6	7	8	9	10	11
BCP24FH		1283	1349	1484	1583	1628	1650	1688	1728	1831	1983	2055

- Cabinet width is 24".
- Adjustable full depth shelf.
- Includes two 3" fillers, shipped unattached. Fillers are required for drawer and door opening clearance of adjacent cabinets.
- Unfinished toekick on front and back of cabinet.
- Will not accept roll trays.
- Peninsula base cabinets are 1/4" deeper to allow back paneling application on adjacent cabinets in a run with standard 24" deep cabinets.

Custom Modifications

AUTH	CBO	CCO	CFNTO	CFP	CFRMO	CND	FB	FD	FPEB	FTK	FTK_V	MIP	P	RD	RECTKALL/BK	RECTKL/R	RT	VTK
•	•	•				•			•	•	•	STD		•	STD ¹	•		•

Construction Upgrades

APW	PLE
•	•

Non Soft-dose Options

NSCFB	NSCH
	•

¹ RECTKBK is standard. RECTKALL is not available.

TABLE OF CONTENTS – UNIVERSAL ACCESS CABINETS

Universal Access Base Cabinets with Adjustable Shelves	.86
Universal Access Sink Base	.86
Universal Access Corner Cabinet	.87
Universal Access Drawer Base	.88
Universal Access Microwave with Deep Drawer	.88
Universal Access Vanity Wall Sink, Removable Sink Base	.88

UNIVERSAL ACCESS NOMENCLATURE

All Universal Access Cabinets are 32 1/2" high unless otherwise noted.

B2432.5

Cabinet Type Cabinet Width

CONSTRUCTION UPGRADES

Mod.	Description
APW	All- plywood Construction
PLE	Plywood Ends

NON SOFT-CLOSE OPTIONS

Mod.	Description
NSCFB	Non Soft-close Guides & Furniture Board Drawers and Roll Trays
NSCH	Non Soft-close Door Hinges

MODIFICATIONS GRID KEY

Mod.	Description
•	Available
STD	Standard on these cabinets
	5 Day Express Response Item

CUSTOM MODIFICATIONS

Mod.	Description
AUTHB	Authentic End - Both
AUTHL	Authentic End - Left
AUTHR	Authentic End - Right
CBO	Cabinet Box Only
CCO	Cabinet Case Only
CFNTO	Cabinet Front Only
CFP	Cabinet False Panel
CFRMO	Cabinet Frame Only
CND	Cabinet with No Door, with Drawer
FB	Finished Ends
FD	Full Depth Shelf
FPEB	Furniture Finished Plywood End Panels
MIP	Matching Interior Plywood
RD	Reduced Depth
RT	Installed Roll Tray
VTK	Void Toekick

Universal Access Cabinets are shipped with an unfinished toekick. Finished toekicks in matching wood veneer or laminate must be ordered separately and field installed.

Standard Universal Access toekick is 4 1/2" tall, which will align with base cabinets.

Heat shields are available for field installation. See page 152.

Full depth shelf kits are available for field installation. See page 145.

UNIVERSAL ACCESS BASE, SINGLE DOOR

12", 15", 18", or 21"

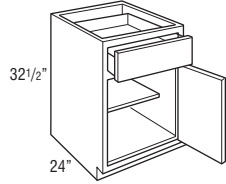

	Price Point	1	2	3	4	5	6	7	8	9	10	11
B1232.5 L or R		574	602	666	709	769	798	812	873	891	973	1049
B1532.5 L or R		618	650	713	761	824	855	871	939	958	1044	1128
B1832.5 L or R		656	687	759	811	874	905	922	997	1017	1112	1202
B2132.5 L or R		700	735	809	865	935	969	988	1068	1090	1183	1280

- Adjustable 15" deep shelf.

Custom Modifications

AUTH	CBO	CCO	CFNTO	CFP	CFRMO	CND	FB	FD	FPEB	MIP	RD	RT	VTK
	•	•	•	•	•	•	•	•	•	•	•	•	•

Construction Upgrades

APW	PLE
•	•

Non Soft-close Options

NSCFB	NSCH
•	•

UNIVERSAL ACCESS BASE, DOUBLE DOOR

24", 30", or 36"

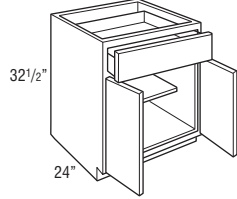

B2432.5		868	913	1004	1070	1157	1200	1227	1320	1347	1469	1571
B3032.5		942	989	1090	1163	1259	1305	1333	1436	1467	1596	1725
B3632.5		1033	1086	1194	1276	1380	1432	1456	1572	1604	1747	1889

- Adjustable 15" deep shelf.

Custom Modifications

AUTH	CBO	CCO	CFNTO	CFP	CFRMO	CND	FB	FD	FPEB	MIP	RD	RT	VTK
	•	•	•	•	•	•	•	•	•	•	•	•	•

Construction Upgrades

APW	PLE
•	•

Non Soft-close Options

NSCFB	NSCH
•	•

UNIVERSAL ACCESS SINK BASE

30" or 36"

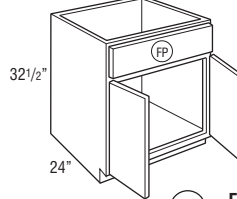

FP = False Panel

SB3032.5		812	856	941	1002	1085	1125	1147	1237	1263	1377	1488
SB3632.5		876	920	1014	1084	1171	1213	1239	1334	1361	1483	1605

- Mini Touch-up Kit (MTUK) included. MTUK includes small touch-up marker and small fill stick.

Custom Modifications

AUTH	CBO	CCO	CFNTO	CFP	CFRMO	CND	FB	FD	FPEB	MIP	RD	RT	VTK
		•	•	STD	•		•		•	•	•		•

Construction Upgrades

APW	PLE
•	•

Non Soft-close Options

NSCFB	NSCH
	•

UNIVERSAL ACCESS SINK BASE, REMOVABLE

30" or 36"

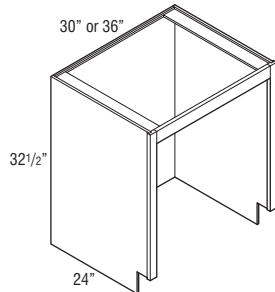
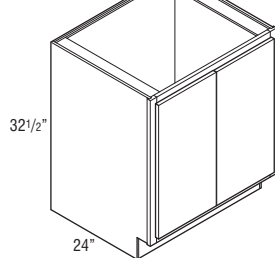

Shown with front, cabinet bottom, and toe kick removed.

UASBRF3032.5		816	860	947	1010	1094	1135	1156	1244	1269	1387	1501
UASBRF3632.5		851	894	986	1052	1140	1182	1204	1301	1328	1444	1563

- Cabinet must be supported on both sides. For end of run, cabinet must be anchored to the floor.
- Front, cabinet bottom, and toe kick are removable.

Custom Modifications

AUTH	CBO	CCO	CFNTO	CFP	CFRMO	CND	FB	FD	FPEB	MIP	RD	RT	VTK
		•					•		STD	•			

Construction Upgrades

APW	PLE
STD	

Non Soft-close Options

NSCFB	NSCH
	•

UNIVERSAL ACCESS SINK BASE, REMOVABLE, 34 1/2" HIGH

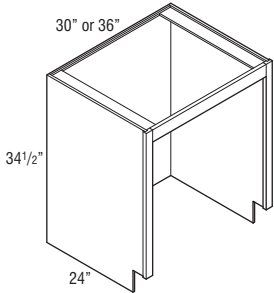
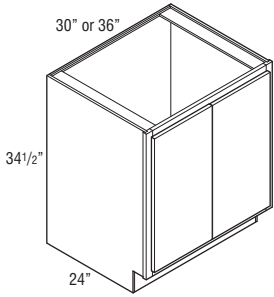

Shown with front, cabinet bottom, and toe kick removed.

UNIVERSAL ACCESS SUPER LAZY SUSAN

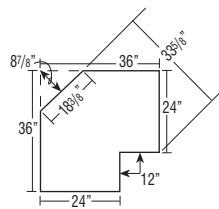
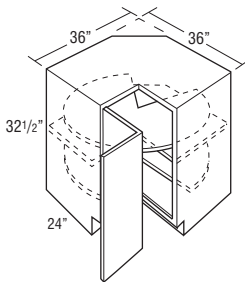

Due to fixed shelf mounting, shelves cannot be retrofitted.

Price Point

	1	2	3	4	5	6	7	8	9	10	11
UASBRF30	816	860	947	1010	1094	1135	1156	1244	1269	1387	1501
UASBRF36	851	894	986	1052	1140	1182	1204	1301	1328	1444	1563

- Cabinet must be supported on both sides. For end of run, cabinet must be anchored to the floor.
- Front, cabinet bottom, and toe kick are removable.

Custom Modifications

AUTH	CBO	CCO	CFNT0	CFP	CFRMO	CND	FB	FD	FPEB	MIP	RD	RT	VTK
•		•					•		STD	•			

Construction Upgrades

APW	PLE
•	
•	

Non Soft-close Options

NSCFB	NSCH
	•

	1890	2019	2142	2434	2628	2724	2775	2882	2910	3042	3178
SLS3632.5 L or R											

- SLS3632.5 L or R wall width is 36" x 36".
- Features two plywood revolving shelves with a 1" plywood lip. Lower shelf is mounted to floor. Upper shelf is mounted to fixed shelf. Fixed shelf is 1/2" thick laminated furniture board.
- Susan is 32" diameter.
- Decorative hardware screws must be countersunk to prevent scratching adjacent cabinets and face frame of SLS.
- Integrated soft-close hinge not included.

Custom Modifications

AUTH	CBO	CCO	CFNT0	CFP	CFRMO	CND	FB	FD	FPEB	MIP	RD	RT	VTK
	•						•		•				•

Construction Upgrades

APW	PLE
•	•

Non Soft-close Options

NSCFB	NSCH
	•
	STD

UNIVERSAL ACCESS THREE DRAWER BASE

15", 18", or 24"

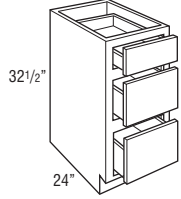

Price Point	1	2	3	4	5	6	7	8	9	10	11
3DB1532.5	875	899	952	985	1041	1068	1072	1122	1145	1197	1254
3DB1832.5	937	961	1019	1054	1115	1145	1150	1201	1226	1281	1343
3DB2432.5	1072	1101	1169	1207	1275	1309	1314	1376	1404	1468	1538

- 1 shallow and 2 deep drawers.

Custom Modifications

AUTH	CBO	CCO	CFNTO	CFP	CFRMO	CND	FB	FD	FPEB	MIP	RD	RT	VTK
	•	•		•	•		•		•		•		•

Construction Upgrades

APW	PLE
•	•

Non Soft-dose Options

NSCFB	NSCH
•	

UNIVERSAL ACCESS BASE MICROWAVE with DEEP DRAWER

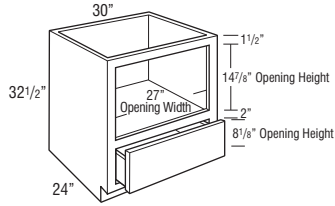

BMWD3032.5DD	1265	1325	1452	1542	1665	1726	1754	1883	1921	2135	2207
--------------	------	------	------	------	------	------	------	------	------	------	------

- 1 deep drawer below microwave.
- Reinforced plywood floor.

Custom Modifications

AUTH	CBO	CCO	CFNTO	CFP	CFRMO	CND	FB	FD	FPEB	MIP	RD	RT	VTK
	•	•			•				•	STD	•		•

Construction Upgrades

APW	PLE

Non Soft-dose Options

NSCFB	NSCH

VANITY WALL SINK

27", 30", or 33"

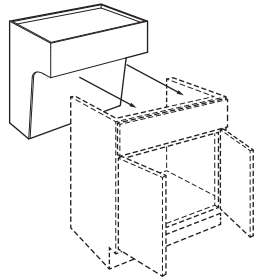
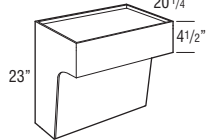

VWS2723	758	758	758	758	758	758	758	758	758	758	758	758
VWS3023	770	770	770	770	770	770	770	770	770	770	770	770
VWS3323	783	783	783	783	783	783	783	783	783	783	783	783

- Recommended installation height of 32" high with 9" of clearance below.
- Front panel is attached with clips for easy removal for access to plumbing.
- Finished veneer plywood exterior and interior.
- For proper installation, cabinet must be secured on each side through both the top and bottom of the back panel into wall studs. Installation instructions and required 3 1/2" installation screws included, standard 2 1/2" installation screws are not sufficient in this application.
- Features a full cabinet top that can be routed for sink installation.
- Approximate weight limit is 400 lbs. per cabinet (includes weight of the cabinet, countertop and contents). Proper installation is required and additional bracing may be required.
- Includes connector clips to mount the sink base to the Removable Vanity Sink Base (RVWS..32). RVWS..32 not included, see below.

Custom Modifications

AUTH	CBO	CCO	CFNTO	CFP	CFRMO	CND	FB	FD	FPEB	MIP	RD	RT	VTK
									STD	STD			

Construction Upgrades

APW	PLE

Non Soft-dose Options

NSCFB	NSCH

REMOVABLE VANITY SINK BASE

30", 33", or 36"

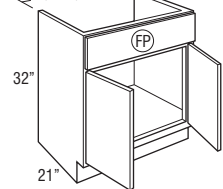

RVWS3032	816	860	947	1010	1094	1135	1156	1244	1269	1387	1501
RVWS3332	833	874	964	1028	1112	1153	1175	1265	1291	1411	1523
RVWS3632	851	894	986	1052	1140	1182	1204	1301	1328	1444	1563

- Must be ordered with Vanity Wall Sink (VWS..23), not designed to be a stand-alone unit.
 - RVWS3032 is compatible with VWS2723
 - RVWS3332 is compatible with VWS3023
 - RVWS3632 is compatible with VWS3323
- Cabinet is able to be removed for handicap accessible use.
- Includes connector clips to mount the sink base to the Vanity Wall Sink (VWS..23).

Custom Modifications

AUTH	CBO	CCO	CFNTO	CFP	CFRMO	CND	FB	FD	FPEB	MIP	RD	RT	VTK
		•	•		•				STD	•			

Construction Upgrades

APW	PLE
STD	

Non Soft-dose Options

NSCFB	NSCH
	•

TABLE OF CONTENTS – TALL CABINETS

Tall Cabinets with Shelves90
Tall Cabinets with Roll Trays95
Tall Appliance Cabinets97

TALL CABINET NOMENCLATURE

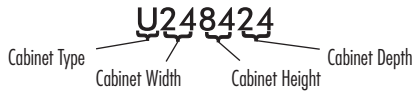

DOOR OPTIONS

Mod.	Description
CG, CG.TOP	Cut-for-glass Doors
MFO	Modified Full Overlay

CONSTRUCTION UPGRADES

Mod.	Description
APW	All-plywood Construction
PLE	Plywood Ends

NON SOFT-CLOSE OPTIONS

Mod.	Description
NSCFB	Non Soft-close Guides & Furniture Board Drawers and Roll Trays
NSCH	Non Soft-close Door Hinges

MODIFICATIONS GRID KEY

Mod.	Description
•	Available
STD	Standard on these cabinets



5 Day Express Response Item

CUSTOM MODIFICATIONS

Mod.	Description
AUTHB	Authentic End - Both
AUTHL	Authentic End - Left
AUTHR	Authentic End - Right
CBO	Cabinet Box Only
CCO	Cabinet Case Only
CFNTO	Cabinet Front Only
CFRMO	Cabinet Frame Only
CND	Cabinet with No Door, with Drawer
FB	Finished Ends
FD	Full Depth Shelf
FPEB	Furniture Finished Plywood End Panels
FTK	Flush Toekick
FTKAV	Flush Toekick Arch
FTKRV	Flush Toekick Furniture
MIP	Matching Interior Plywood
RD	Reduced Depth
RECTKL	Recessed Toekick Left
RECTKR	Recessed Toekick Right
RT	Installed Roll Tray
VTK	Void Toekick

Utility cabinets with depths of 12" must be installed to studs in wall or onto the end of another tall cabinet.

Remember to apply an end panel skin to all tall cabinets when installing next to a base and a wall cabinet to avoid notching the countertop around the face frame.

Apply an end panel skin to create a flush end on the side of a tall cabinet if installed at the end of a run for ease of moulding installation.

Separate pedestal base included but may be packaged separately on 93" and 96" tall. Pedestal is designed to create a Recessed Left or Right Toekick application during field installation, or can be centered. Pedestal must be covered with toeboard material.

Reduced depth available to 12" on tall cabinets without drawers. Reduced Depth available to 18" on tall cabinets with drawers or roll trays.

Tall mitered door styles and laminate door styles will feature one center panel; other door styles will feature two center panels.

UTILITY, 84" or 87" TALL, 12" DEEP

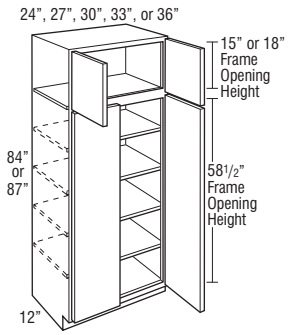
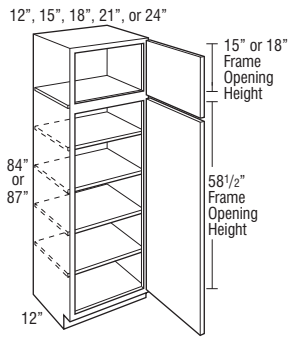

Price Point

	1	2	3	4	5	6	7	8	9	10	11
U128412 L or R	1033	1094	1188	1252	1344	1390	1417	1523	1554	1672	1794
U158412 L or R	1073	1141	1237	1304	1400	1449	1479	1584	1617	1740	1868
U188412 L or R	1104	1145	1244	1310	1407	1455	1484	1593	1626	1748	1875
U218412 L or R	1240	1301	1416	1491	1605	1661	1692	1814	1851	1993	2141
U248412 L or R	1343	1456	1588	1670	1799	1863	1897	2036	2077	2238	2405
U128712 L or R	1066	1123	1225	1287	1385	1433	1460	1565	1596	1721	1846
U158712 L or R	1113	1172	1276	1340	1442	1492	1520	1630	1664	1791	1924
U188712 L or R	1193	1295	1411	1486	1598	1652	1684	1807	1844	1987	2137
U218712 L or R	1303	1397	1521	1602	1724	1785	1820	1952	1991	2146	2308
U248712 L or R	1386	1499	1632	1720	1852	1917	1953	2075	2139	2307	2477

U248412	1427	1554	1694	1786	1902	1959	2028	2131	2218	2391	2533
U278412	1479	1604	1748	1844	1983	2051	2092	2244	2290	2468	2655
U308412	1529	1654	1803	1900	2044	2116	2155	2312	2359	2543	2737
U338412	1641	1766	1926	2029	2183	2261	2303	2470	2520	2718	2926
U368412	1751	1879	2049	2160	2324	2406	2451	2627	2680	2893	3114
U248712	1469	1601	1743	1837	1977	2047	2087	2176	2282	2463	2582
U278712	1524	1651	1799	1896	2041	2113	2154	2279	2356	2542	2701
U308712	1577	1701	1854	1954	2104	2179	2220	2380	2429	2620	2818
U338712	1691	1817	1981	2089	2247	2326	2373	2545	2597	2802	3012
U368712	1805	1934	2106	2221	2392	2476	2523	2708	2762	2980	3207

Custom Modifications

AUTH	CBO	CCO	CFNTO	CFRMO	CND	FB	FD	FPEB	FTK	FTK_V	MIP	RD	RECTKL/R	RT	VTK
•	•	•	•	•	•	•	•	•	•	• ¹	•	•	•	•	•

Construction Upgrades

APW	PLE
•	•

Door Options

CG	CG.TOP	MFO
•	•	•

Non Soft-close Options

NSCFB	NSCH
•	•

¹ Not available on 12" wide

UTILITY, 90" TALL, 12" DEEP

12", 15", 18", 21", or 24"

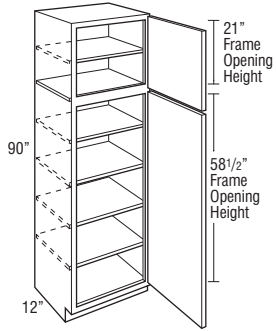

24", 27", 30", 33", or 36"

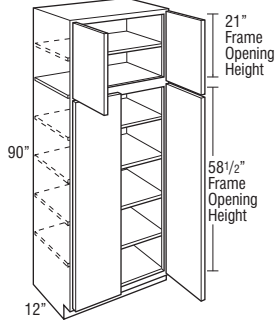

Price Point

	1	2	3	4	5	6	7	8	9	10	11
U129012 L or R	1088	1132	1232	1295	1394	1443	1470	1575	1608	1732	1860
U159012 L or R	1134	1180	1284	1349	1452	1502	1530	1640	1674	1804	1938
U189012 L or R	1235	1332	1453	1530	1646	1703	1734	1841	1899	2047	2202
U219012 L or R	1341	1422	1547	1631	1754	1815	1852	1986	2027	2186	2349
U249012 L or R	1414	1508	1646	1732	1864	1930	1967	2109	2152	2323	2495

U249012	1496	1612	1756	1851	1992	2062	2103	2217	2299	2480	2634
U279012	1554	1663	1812	1910	2056	2128	2170	2308	2373	2560	2737
U309012	1611	1713	1866	1969	2120	2193	2236	2397	2445	2639	2840
U339012	1726	1829	1994	2104	2263	2342	2389	2564	2616	2822	3035
U369012	1841	1946	2121	2237	2408	2492	2542	2728	2783	3002	3231

Custom Modifications

AUTH	CBO	CCO	CFNTO	CFRMO	CND	FB	FD	FPEB	FTK	FTK_V	MIP	RD	RECTKL/R	RT	VTK
•	•	•	•	•	•	•	•	•	•	• ¹	•	•	•	•	•

Construction Upgrades

APW	PLE
•	•

Door Options

CG	CG.TOP	MFO
•	•	•

Non Soft-close Options

NSCFB	NSCH
•	•

¹ Not available on 12" wide

UTILITY, 93" or 96" TALL, 12" DEEP

12", 15", 18", 21", or 24"

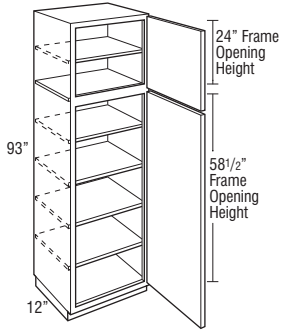

24", 27", 30", 33", or 36"

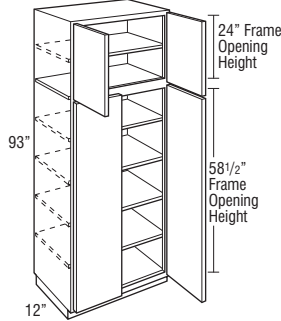

12", 15", 18", 21", or 24"

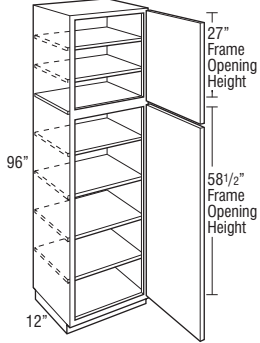

24", 27", 30", 33", or 36"

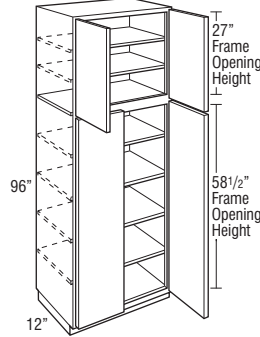

Price Point	1	2	3	4	5	6	7	8	9	10	11
U129312 L or R	1126	1171	1275	1341	1443	1493	1524	1632	1666	1794	1927
U159312 L or R	1171	1218	1328	1398	1505	1557	1588	1701	1735	1868	2010
U189312 L or R	1301	1381	1504	1584	1705	1764	1798	1928	1967	2122	2283
U219312 L or R	1413	1471	1605	1689	1819	1883	1920	2060	2102	2267	2436
U249312 L or R	1486	1564	1703	1796	1932	2000	2040	2187	2232	2407	2590

U249312	1560	1667	1820	1919	2067	2140	2181	2294	2386	2576	2723
U279312	1623	1721	1879	1982	2132	2207	2249	2414	2463	2658	2858
U309312	1685	1775	1937	2042	2197	2274	2319	2488	2538	2738	2946
U339312	1808	1896	2067	2179	2348	2432	2478	2658	2712	2927	3149
U369312	1935	2014	2200	2318	2498	2587	2635	2826	2883	3114	3352

U129612 L or R	1126	1171	1275	1341	1443	1493	1524	1632	1666	1794	1927
U159612 L or R	1171	1218	1328	1398	1505	1557	1588	1701	1735	1868	2010
U189612 L or R	1301	1381	1504	1584	1705	1764	1798	1928	1967	2122	2283
U219612 L or R	1413	1471	1605	1689	1819	1883	1920	2060	2102	2267	2436
U249612 L or R	1486	1564	1703	1796	1932	2000	2040	2187	2232	2407	2590

U249612	1560	1667	1820	1919	2067	2140	2181	2294	2386	2576	2723
U279612	1623	1721	1879	1982	2132	2207	2249	2414	2463	2658	2858
U309612	1685	1775	1937	2042	2197	2274	2319	2488	2538	2738	2946
U339612	1808	1896	2067	2179	2348	2432	2478	2658	2712	2927	3149
U369612	1935	2014	2200	2318	2498	2587	2635	2826	2883	3114	3352

Custom Modifications

AUTH	CBO	CCO	CFNTO	CFRMO	CND	FB	FD	FPEB	FTK	FTK_V	MIP	RD	RECTKL/R	RT	VTK
•	•	•	•	•		•		•	•	• ¹	•				

Construction Upgrades

APW	PLE
•	•

Door Options

CG	CG.TOP	MFO
		•

Non Soft-close Options

NSCFB	NSCH
	•

¹ Not available on 12" wide

**UTILITY, 84", 87", or 90" TALL,
24" DEEP**

12", 15", 18", 21", or 24"

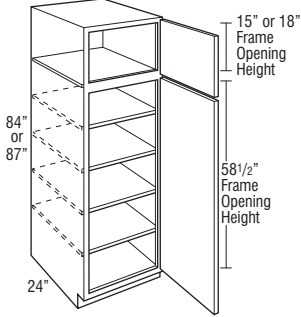

24", 27", 30", 33", or 36"

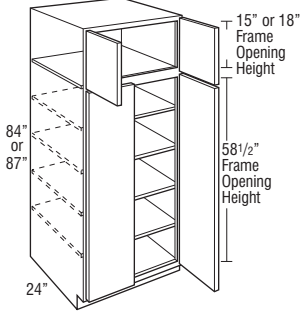

12", 15", 18", 21", or 24"

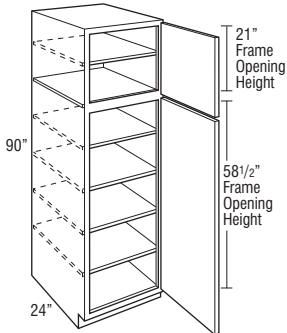

24", 27", 30", 33", or 36"

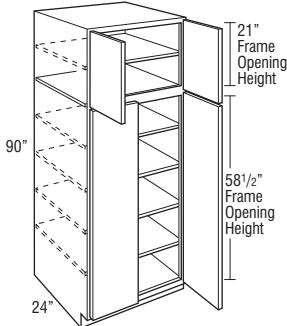

	Price Point	1	2	3	4	5	6	7	8	9	10	11
U128424 L or R		1076	1191	1405	1471	1516	1538	1604	1669	1772	1913	1984
U158424 L or R		1122	1241	1465	1535	1580	1602	1670	1739	1847	1996	2068
U188424 L or R		1265	1411	1642	1704	1745	1766	1826	1887	2005	2165	2245
U218424 L or R		1392	1551	1817	1876	1921	1944	2011	2079	2207	2382	2472
U248424 L or R		1624	1773	1922	2013	2089	2127	2172	2216	2348	2540	2631
U128724 L or R		1118	1237	1456	1521	1564	1585	1650	1714	1818	1964	2037
U158724 L or R		1163	1287	1518	1584	1629	1651	1717	1784	1892	2049	2123
U188724 L or R		1309	1460	1679	1743	1785	1806	1870	1932	2049	2214	2296
U218724 L or R		1437	1603	1846	1916	1963	1986	2056	2125	2253	2436	2526
U248724 L or R		1667	1824	1976	2069	2143	2180	2218	2257	2395	2590	2684

U248424	1820	1887	2048	2143	2255	2311	2330	2350	2490	2694	2789
U278424	1875	1944	2109	2209	2372	2452	2500	2637	2729	2930	3143
U308424	1930	2001	2171	2275	2443	2526	2575	2755	2811	3018	3238
U338424	2055	2128	2312	2426	2604	2693	2747	2938	2998	3219	3455
U368424	2180	2258	2454	2574	2767	2862	2917	3122	3185	3421	3673
U248724	1870	1938	2105	2206	2317	2372	2382	2392	2535	2742	2840
U278724	1927	1995	2170	2272	2440	2523	2573	2684	2811	3016	3188
U308724	1982	2055	2232	2337	2513	2599	2648	2835	2892	3105	3331
U338724	2109	2188	2376	2491	2677	2769	2824	3023	3084	3313	3556
U368724	2237	2321	2522	2646	2844	2942	2999	3212	3276	3521	3779

U129024 L or R	1157	1281	1480	1551	1596	1620	1689	1759	1865	2013	2089
U159024 L or R	1206	1334	1543	1614	1663	1686	1759	1829	1938	2100	2177
U189024 L or R	1350	1507	1714	1779	1823	1845	1910	1975	2094	2262	2345
U219024 L or R	1486	1658	1880	1968	2010	2030	2103	2173	2302	2487	2579
U249024 L or R	1697	1835	1988	2084	2182	2230	2266	2302	2439	2639	2733

U249024	1883	1950	2121	2219	2326	2378	2414	2448	2576	2785	2887
U279024	1939	2009	2184	2286	2457	2541	2590	2730	2831	3037	3259
U309024	1994	2068	2247	2352	2529	2617	2667	2856	2914	3128	3356
U339024	2124	2205	2394	2510	2697	2789	2844	3046	3107	3336	3582
U369024	2253	2337	2538	2664	2862	2961	3019	3235	3300	3545	3805

• Depth can be reduced to a minimum of 15".

Custom Modifications

AUTH	CBO	CCO	CFNTO	CFRMO	CND	FB	FD	FPEB	FTK	FTK_V	MIP	RD	RECTKL/R	RT	VTK
•	•	•	•	•		•		•	•	• ¹	•	•	•	•	•

Construction Upgrades

APW	PLE
•	•

Door Options

CG	CG.TOP	MFO
		•

Non Soft-close Options

NSCFB	NSCH
	•

¹ Not available on 12" wide

UTILITY, 93" or 96" TALL, 24" DEEP

12", 15", 18", 21", or 24"

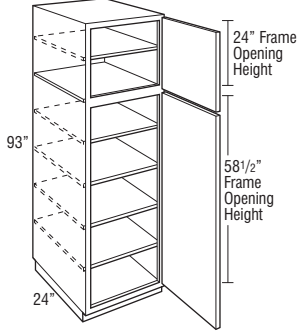

24", 27", 30", 33", or 36"

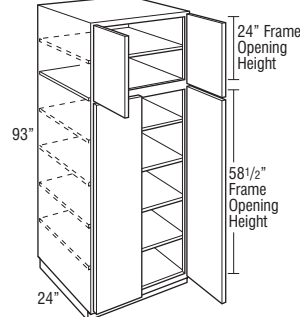

12", 15", 18", 21", or 24"

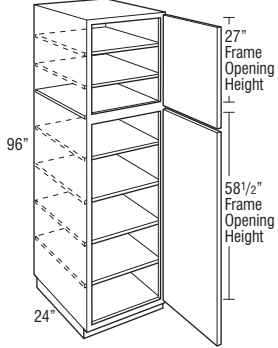

24", 27", 30", 33", or 36"

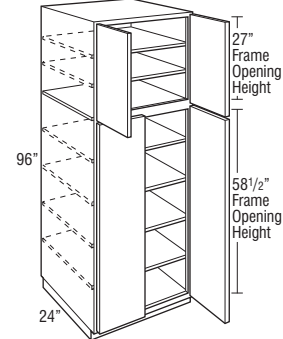

Price Point

	1	2	3	4	5	6	7	8	9	10	11
U129324 L or R	1235	1367	1535	1612	1664	1689	1768	1844	1958	2112	2189
U159324 L or R	1287	1425	1599	1679	1733	1760	1841	1920	2038	2202	2282
U189324 L or R	1432	1601	1789	1857	1902	1925	1993	2059	2183	2360	2444
U219324 L or R	1564	1731	1944	2037	2090	2117	2192	2266	2402	2596	2690
U249324 L or R	1768	1897	2059	2159	2275	2333	2360	2386	2529	2733	2835

U249324	1946	2018	2190	2299	2432	2498	2503	2506	2658	2873	2979
U279324	2005	2080	2257	2369	2545	2631	2684	2815	2929	3149	3344
U309324	2062	2140	2323	2439	2620	2710	2762	2958	3018	3243	3481
U339324	2196	2279	2476	2600	2792	2887	2944	3153	3217	3458	3714
U369324	2330	2417	2630	2759	2964	3066	3125	3350	3418	3675	3946

U129624 L or R	1235	1367	1535	1612	1664	1689	1768	1844	1958	2112	2189
U159624 L or R	1287	1425	1599	1679	1733	1760	1841	1920	2038	2202	2282
U189624 L or R	1432	1601	1789	1857	1902	1925	1993	2059	2183	2360	2444
U219624 L or R	1564	1731	1944	2037	2090	2117	2192	2266	2402	2596	2690
U249624 L or R	1768	1897	2059	2159	2275	2333	2360	2386	2529	2733	2835

U249624	1946	2018	2190	2299	2388	2432	2469	2506	2658	2873	2979
U279624	2005	2080	2257	2369	2545	2631	2684	2871	2929	3149	3344
U309624	2062	2140	2323	2439	2620	2710	2762	2958	3018	3243	3481
U339624	2196	2279	2476	2600	2792	2887	2944	3153	3217	3458	3714
U369624	2330	2417	2630	2759	2964	3066	3125	3350	3418	3675	3946

• Depth can be reduced to a minimum of 15".

Custom Modifications

AUTH	CBO	CCO	CFNTO	CFRMO	CND	FB	FD	FPEB	FTK	FTK_V	MIP	RD	RECTKL/R	RT	VTK
•	•	•	•	•	•	•	•	•	•	• ¹	•	•	•	•	•

Construction Upgrades

APW	PLE
•	•

Door Options

CG	CG.TOP	MFO
•	•	•

Non Soft-close Options

NSCFB	NSCH
•	•

¹ Not available on 12" wide

UTILITY with ROLL TRAYS, 84", 87", or 90" TALL, 24" DEEP

12", 15", 18", 21", or 24"

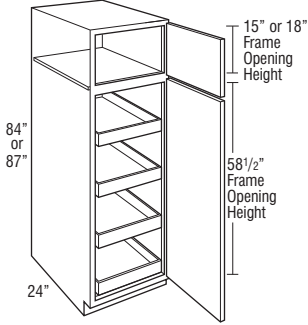

24", 27", 30", 33", or 36"

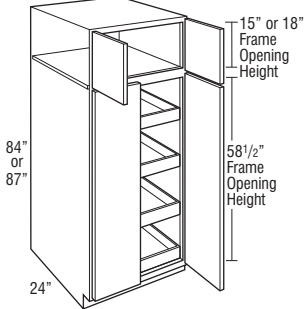

12", 15", 18", 21", or 24"

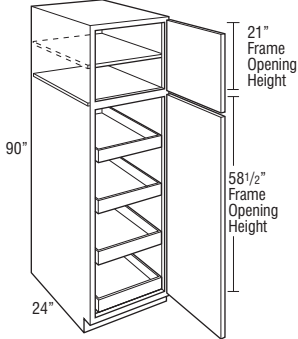

24", 27", 30", 33", or 36"

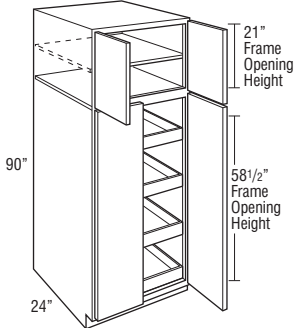

Price Point

	1	2	3	4	5	6	7	8	9	10	11
U128424RT L or R	1648	1763	1977	2043	2088	2110	2176	2241	2344	2485	2556
U158424RT L or R	1694	1813	2037	2107	2152	2174	2242	2311	2419	2568	2640
U188424RT L or R	1837	1983	2214	2276	2317	2338	2398	2459	2577	2737	2817
U218424RT L or R	1964	2123	2389	2448	2493	2516	2583	2651	2779	2954	3044
U248424RT L or R	2196	2345	2494	2585	2661	2699	2744	2788	2920	3112	3203
U128724RT L or R	1690	1809	2028	2093	2136	2157	2222	2286	2390	2536	2609
U158724RT L or R	1735	1859	2090	2156	2201	2223	2289	2356	2464	2621	2695
U188724RT L or R	1881	2032	2251	2315	2357	2378	2442	2504	2621	2786	2868
U218724RT L or R	2009	2175	2418	2488	2535	2558	2628	2697	2825	3008	3098
U248724RT L or R	2239	2396	2548	2641	2715	2752	2790	2829	2967	3162	3256

U248424RT	2392	2459	2620	2715	2827	2883	2902	2922	3062	3266	3361
U278424RT	2447	2516	2681	2781	2944	3024	3072	3209	3301	3502	3715
U308424RT	2502	2573	2743	2847	3015	3098	3147	3327	3383	3590	3810
U338424RT	2627	2700	2884	2998	3176	3265	3319	3510	3570	3791	4027
U368424RT	2752	2830	3026	3146	3339	3434	3489	3694	3757	3993	4245
U248724RT	2442	2510	2677	2778	2889	2944	2954	2964	3107	3314	3412
U278724RT	2499	2567	2742	2844	3012	3095	3145	3256	3383	3588	3760
U308724RT	2554	2627	2804	2909	3085	3171	3220	3407	3464	3677	3903
U338724RT	2681	2760	2948	3063	3249	3341	3396	3595	3656	3885	4128
U368724RT	2809	2893	3094	3218	3416	3514	3571	3784	3848	4093	4351

U129024RT L or R	1729	1853	2052	2123	2168	2192	2261	2331	2437	2585	2661
U159024RT L or R	1778	1906	2115	2186	2235	2258	2331	2401	2510	2672	2749
U189024RT L or R	1922	2079	2286	2351	2395	2417	2482	2547	2666	2834	2917
U219024RT L or R	2058	2230	2452	2540	2582	2602	2675	2745	2874	3059	3151
U249024RT L or R	2269	2407	2560	2656	2754	2802	2838	2874	3011	3211	3305

U249024RT	2455	2522	2693	2791	2898	2950	2986	3020	3148	3357	3459
U279024RT	2511	2581	2756	2858	3029	3113	3162	3302	3403	3609	3831
U309024RT	2566	2640	2819	2924	3101	3189	3239	3428	3486	3700	3928
U339024RT	2696	2777	2966	3082	3269	3361	3416	3618	3679	3908	4154
U369024RT	2825	2909	3110	3236	3434	3533	3591	3807	3872	4117	4377

Custom Modifications

AUTH	CBO	CCO	CFNTO	CFRMO	CND	FB	FD	FPEB	FTK	FTK_V	MIP	RD	RECTKL/R	RT	VTK
•	•	•	•	•	•	•	•	•	•	• ¹	•	•	•	•	•

Construction Upgrades

APW	PLE
•	•

Door Options

CG	CG.TOP	MFO
•	•	•

Non Soft-close Options

NSCFB	NSCH
•	•

¹ Not available on 12" wide

UTILITY with ROLL TRAYS, 93" or 96" TALL, 24" DEEP

12", 15", 18", 21", or 24"

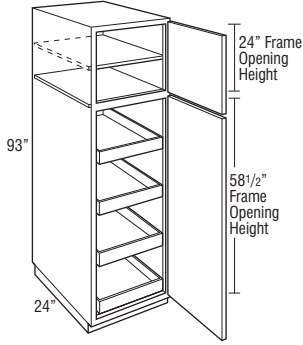

24", 27", 30", 33", or 36"

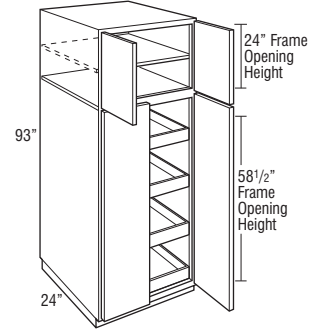

12", 15", 18", 21", or 24"

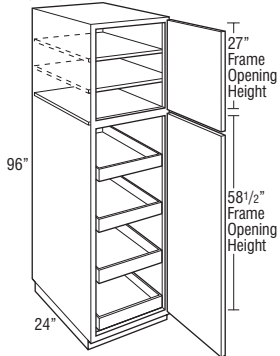

24", 27", 30", 33", or 36"

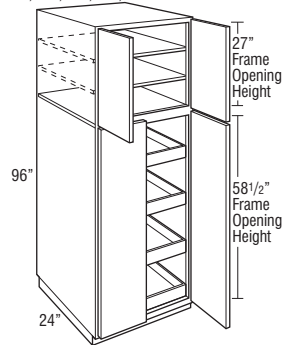

Price Point

	1	2	3	4	5	6	7	8	9	10	11
U129324RT L or R	1807	1939	2107	2184	2236	2261	2340	2416	2530	2684	2761
U159324RT L or R	1859	1997	2171	2251	2305	2332	2413	2492	2610	2774	2854
U189324RT L or R	2004	2173	2361	2429	2474	2497	2565	2631	2755	2932	3016
U219324RT L or R	2136	2303	2516	2609	2662	2689	2764	2838	2974	3168	3262
U249324RT L or R	2340	2469	2631	2731	2847	2905	2932	2958	3101	3305	3407

U249324RT	2518	2590	2762	2871	3004	3070	3075	3078	3230	3445	3551
U279324RT	2577	2652	2829	2941	3117	3203	3256	3387	3501	3721	3916
U309324RT	2634	2712	2895	3011	3192	3282	3334	3530	3590	3815	4053
U339324RT	2768	2851	3048	3172	3364	3459	3516	3725	3789	4030	4286
U369324RT	2902	2989	3202	3331	3536	3638	3697	3922	3990	4247	4518

U129624RT L or R	1807	1939	2107	2184	2236	2261	2340	2416	2530	2684	2761
U159624RT L or R	1859	1997	2171	2251	2305	2332	2413	2492	2610	2774	2854
U189624RT L or R	2004	2173	2361	2429	2474	2497	2565	2631	2755	2932	3016
U219624RT L or R	2136	2303	2516	2609	2662	2689	2764	2838	2974	3168	3262
U249624RT L or R	2340	2469	2631	2731	2847	2905	2932	2958	3101	3305	3407

U249624RT	2518	2590	2762	2871	2960	3004	3041	3078	3230	3445	3551
U279624RT	2577	2652	2829	2941	3117	3203	3256	3443	3501	3721	3916
U309624RT	2634	2712	2895	3011	3192	3282	3334	3530	3590	3815	4053
U339624RT	2768	2851	3048	3172	3364	3459	3516	3725	3789	4030	4286
U369624RT	2902	2989	3202	3331	3536	3638	3697	3922	3990	4247	4518

Custom Modifications

AUTH	CBO	CCO	CFNTO	CFRMO	CND	FB	FD	FPEB	FTK	FTK_V	MIP	RD	RECTKL/R	RT	VTK
•	•	•	•	•		•		•	•	• ¹	•	•			

Construction Upgrades

APW	PLE
•	•

Door Options

CG	CG.TOP	MFO
		•

Non Soft-close Options

NSCFB	NSCH
•	•

¹ Not available on 12" wide

SINGLE OVEN CABINET, 84", 87", 90", 93", or 96" TALL, 24" DEEP

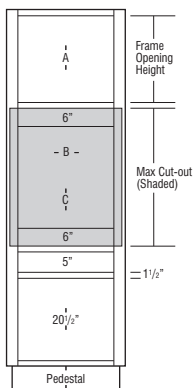
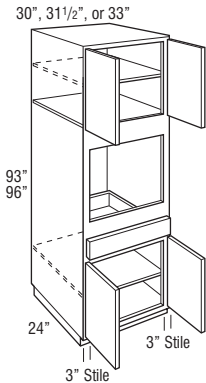
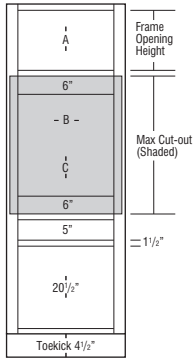
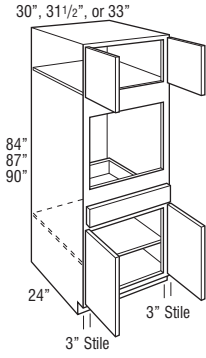

Price Point	1	2	3	4	5	6	7	8	9	10	11
OSB308424	1670	1754	1934	2064	2233	2316	2361	2545	2597	2831	3059
OSB31.58424	1727	1816	2002	2137	2311	2398	2444	2633	2687	2930	3167
OSB338424	1784	1878	2069	2209	2389	2479	2526	2721	2776	3028	3274
OSB308724	1784	1876	2068	2209	2389	2478	2526	2721	2776	3027	3275
OSB31.58724	1845	1940	2137	2282	2468	2561	2610	2812	2869	3128	3385
OSB338724	1906	2003	2205	2354	2547	2643	2694	2902	2961	3228	3494
OSB309024	1814	1907	2100	2244	2428	2518	2566	2767	2823	3076	3327
OSB31.59024	1875	1972	2169	2318	2507	2600	2651	2857	2915	3178	3438
OSB339024	1936	2036	2237	2391	2585	2682	2736	2947	3007	3279	3549

OSB309324	1962	2064	2267	2423	2621	2719	2768	2986	3047	3322	3593
OSB31.59324	2023	2126	2339	2498	2703	2804	2856	3080	3142	3425	3705
OSB339324	2083	2188	2411	2573	2785	2889	2944	3173	3237	3528	3817
OSB309624	1962	2064	2267	2423	2621	2719	2768	2986	3047	3322	3593
OSB31.59624	2023	2126	2339	2498	2703	2804	2856	3080	3142	3425	3705
OSB339624	2083	2188	2411	2573	2785	2889	2944	3173	3237	3528	3817

- Uses face mount hinges, doors and drawer fronts have a consistent width reveal for full overlay (1/4") and partial overlay (1").
- Base section will utilize a full depth shelf.
- 90", 93", and 96" tall include full depth adjustable shelves in upper section:
90" and 93" tall - one shelf
96" tall - two shelves
- Oven cavity is standard interior.
- All top and bottom cross rails are 1 1/2" wide.
- All cabinets have 3" stiles on frame.
- Be sure to confirm a heat shield is built into your appliance by the manufacturer or install the heat shield included with your appliance. Heat shields are sold separately as an accessory.
- Shelf support for oven not included; for built-in appliance support brackets, use OCINSTALLKIT (included in 24" deep cabinets).
- OCINSTALLKIT weight limit is 400 lbs. per pair.
- Maximum cut-out dimension will allow 1/4" reveal for doors and drawer fronts on full overlay and 1" for partial overlay for trim kit face clearance.
- Oven cabinet cut-out is shaded in gray and is cut out on job site.

	A Frame Opening Height	B Cut-out Width		C Cut-out Height		Door Height (Upper Section)	
		Min.	Max.	Min.	Max.	Partial Overlay	Full Overlay
OSB308424	15"	24"	28 1/2"	22 1/2"	31 1/2"	16"	17 1/2"
OSB31.58424	15"	25 1/2"	30"	22 1/2"	31 1/2"	16"	17 1/2"
OSB338424	15"	27"	31 1/2"	22 1/2"	31 1/2"	16"	17 1/2"
OSB308724	18"	24"	28 1/2"	22 1/2"	31 1/2"	19"	20 1/2"
OSB31.58724	18"	25 1/2"	30"	22 1/2"	31 1/2"	19"	20 1/2"
OSB338724	18"	27"	31 1/2"	22 1/2"	31 1/2"	19"	20 1/2"
OSB309024	21"	24"	28 1/2"	22 1/2"	31 1/2"	22"	23 1/2"
OSB31.59024	21"	25 1/2"	30"	22 1/2"	31 1/2"	22"	23 1/2"
OSB339024	21"	27"	31 1/2"	22 1/2"	31 1/2"	22"	23 1/2"
OSB309324	24"	24"	28 1/2"	22 1/2"	31 1/2"	25"	26 1/2"
OSB31.59324	24"	25 1/2"	30"	22 1/2"	31 1/2"	25"	26 1/2"
OSB339324	24"	27"	31 1/2"	22 1/2"	31 1/2"	25"	26 1/2"
OSB309624	27"	24"	28 1/2"	22 1/2"	31 1/2"	28"	29 1/2"
OSB31.59624	27"	25 1/2"	30"	22 1/2"	31 1/2"	28"	29 1/2"
OSB339624	27"	27"	31 1/2"	22 1/2"	31 1/2"	28"	29 1/2"

Custom Modifications

AUTH	CBO	CCO	CFNTO	CFRMO	CND	FB	FD	FPEB	FTK	FTK_V	MIP	RD	RECTKL/R	RT	VTK
•	•	•	•	•	•	•	•	•	•	•	•	•	• ¹	•	• ¹

Construction Upgrades

APW	PLE
•	•

Door Options

CG	CG.TOP	MFO
•	•	•

Non Soft-close Options

NSCFB	NSCH
•	•

¹ Only available on 84", 87", and 90" tall

SINGLE OVEN CABINET NARROW RAIL, 84", 87", 90", 93", or 96" TALL, 24" DEEP

30", 31 1/2", or 33"

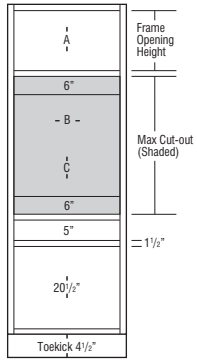
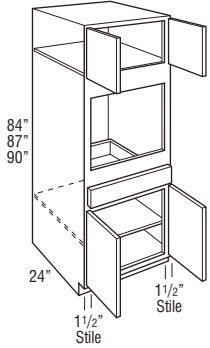

30", 31 1/2", or 33"

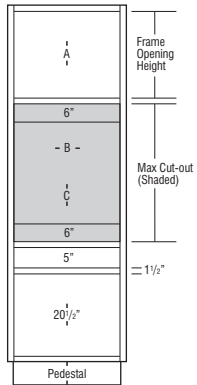
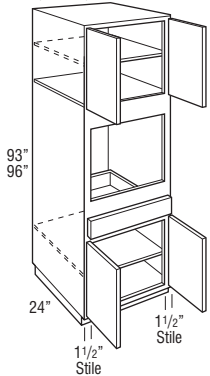

Price Point	1	2	3	4	5	6	7	8	9	10	11
OSB308424N	1670	1754	1934	2064	2233	2316	2361	2545	2597	2831	3059
OSB31.58424N	1727	1816	2002	2137	2311	2398	2444	2633	2687	2930	3167
OSB338424N	1784	1878	2069	2209	2389	2479	2526	2721	2776	3028	3274
OSB308724N	1784	1876	2068	2209	2389	2478	2526	2721	2776	3027	3275
OSB31.58724N	1845	1940	2137	2282	2468	2561	2610	2812	2869	3128	3385
OSB338724N	1906	2003	2205	2354	2547	2643	2694	2902	2961	3228	3494
OSB309024N	1814	1907	2100	2244	2428	2518	2566	2767	2823	3076	3327
OSB31.59024N	1875	1972	2169	2318	2507	2600	2651	2857	2915	3178	3438
OSB339024N	1936	2036	2237	2391	2585	2682	2736	2947	3007	3279	3549

OSB309324N	1962	2064	2267	2423	2621	2719	2768	2986	3047	3322	3593
OSB31.59324N	2023	2126	2339	2498	2703	2804	2856	3080	3142	3425	3705
OSB339324N	2083	2188	2411	2573	2785	2889	2944	3173	3237	3528	3817
OSB309624N	1962	2064	2267	2423	2621	2719	2768	2986	3047	3322	3593
OSB31.59624N	2023	2126	2339	2498	2703	2804	2856	3080	3142	3425	3705
OSB339624N	2083	2188	2411	2573	2785	2889	2944	3173	3237	3528	3817

- Base section will utilize a full depth shelf.
- 90", 93", and 96" tall include full depth adjustable shelves in upper section:
90" and 93" tall - one shelf
96" tall - two shelves
- Oven cavity is standard interior.
- All top and bottom cross rails are 1 1/2" wide.
- Be sure to confirm a heat shield is built into your appliance by the manufacturer or install the heat shield included with your appliance. Heat shields are sold separately as an accessory.
- Support shelf for oven not included; for built-in appliance support brackets, use OCINSTALLKIT (included in 24" deep cabinets).
- OCINSTALLKIT weight limit is 400 lbs. per pair.
- Maximum cut-out dimension will allow 1/4" reveal for doors and drawer fronts on full overlay and 1" for partial overlay for trim kit face clearance.
- Oven cabinet cut-out is shaded in gray and is cut out on job site.

	A Frame Opening Height	B Cut-out Width		C Cut-out Height		Door Height (Upper Section)	
		Min.	Max.	Min.	Max.	Partial Overlay	Full Overlay
OSB308424N	15"	27"	28 1/2"	22 1/2"	31 1/2"	16"	17 1/2"
OSB31.58424N	15"	28 1/2"	30"	22 1/2"	31 1/2"	16"	17 1/2"
OSB338424N	15"	30"	31 1/2"	22 1/2"	31 1/2"	16"	17 1/2"
OSB308724N	18"	27"	28 1/2"	22 1/2"	31 1/2"	19"	20 1/2"
OSB31.58724N	18"	28 1/2"	30"	22 1/2"	31 1/2"	19"	20 1/2"
OSB338724N	18"	30"	31 1/2"	22 1/2"	31 1/2"	19"	20 1/2"
OSB309024N	21"	27"	28 1/2"	22 1/2"	31 1/2"	22"	23 1/2"
OSB31.59024N	21"	28 1/2"	30"	22 1/2"	31 1/2"	22"	23 1/2"
OSB339024N	21"	30"	31 1/2"	22 1/2"	31 1/2"	22"	23 1/2"
OSB309324N	24"	27"	28 1/2"	22 1/2"	31 1/2"	25"	26 1/2"
OSB31.59324N	24"	28 1/2"	30"	22 1/2"	31 1/2"	25"	26 1/2"
OSB339324N	24"	30"	31 1/2"	22 1/2"	31 1/2"	25"	26 1/2"
OSB309624N	27"	27"	28 1/2"	22 1/2"	31 1/2"	28"	29 1/2"
OSB31.59624N	27"	28 1/2"	30"	22 1/2"	31 1/2"	28"	29 1/2"
OSB339624N	27"	30"	31 1/2"	22 1/2"	31 1/2"	28"	29 1/2"

Custom Modifications

AUTH	CBO	CCO	CFNTO	CFRMO	CND	FB	FD	FPEB	FTK	FTK_V	MIP	RD	RECTKL/R	RT	VTK
•	•	•	•	•	•	•	•	•	•	•	•	•	•	•	•

Construction Upgrades

APW	PLE
•	•

Door Options

CG	CG.TOP	MFO
•	•	•

Non Soft-close Options

NSCFB	NSCH
•	•

¹ Not available on 84", 87", and 90" tall

DOUBLE OVEN CABINET, 84", 87", 90", 93", or 96" TALL, 24" DEEP

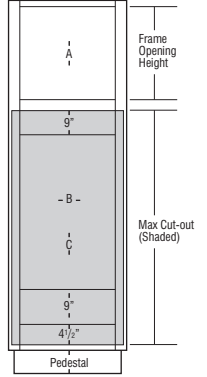
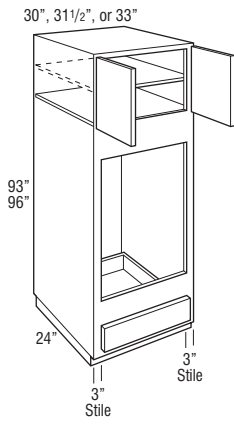
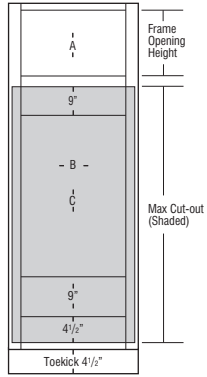
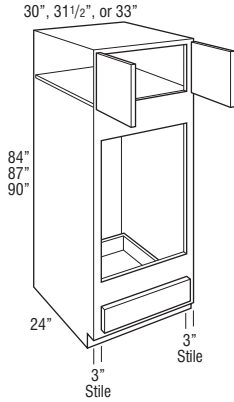

Price Point	1	2	3	4	5	6	7	8	9	10	11
OCD308424	1446	1520	1675	1787	1932	2005	2043	2205	2249	2450	2649
OCD31.58424	1496	1574	1733	1849	2000	2075	2115	2281	2327	2536	2742
OCD338424	1546	1627	1790	1910	2067	2145	2187	2357	2405	2621	2835
OCD308724	1546	1627	1788	1910	2067	2145	2187	2357	2405	2619	2834
OCD31.58724	1598	1681	1849	1975	2137	2217	2260	2435	2484	2707	2929
OCD338724	1650	1735	1909	2039	2206	2288	2332	2513	2563	2794	3023
OCD309024	1572	1654	1818	1941	2102	2181	2221	2395	2443	2662	2881
OCD31.59024	1624	1708	1879	2006	2171	2252	2295	2474	2523	2751	2976
OCD339024	1676	1762	1940	2071	2239	2322	2368	2552	2603	2839	3070

OCD309324	1698	1787	1965	2098	2268	2352	2397	2585	2638	2877	3113
OCD31.59324	1751	1842	2027	2164	2340	2426	2473	2667	2721	2967	3209
OCD339324	1803	1897	2089	2229	2411	2500	2548	2748	2804	3056	3304
OCD309624	1698	1787	1965	2098	2268	2352	2397	2585	2638	2877	3113
OCD31.59624	1751	1842	2027	2164	2340	2426	2473	2667	2721	2967	3209
OCD339624	1803	1897	2089	2229	2411	2500	2548	2748	2804	3056	3304

- Uses face mount hinges, doors and drawer fronts have a consistent width reveal for full overlay (1/4") and partial overlay (1").
- 90", 93", and 96" tall include full depth adjustable shelves in upper section:
 - 90" and 93" tall - one shelf
 - 96" tall - two shelves
- Oven cavity is standard interior.
- For built-in double oven applications, remove drawer as needed.
- All top and bottom cross rails are 1 1/2" wide.
- All cabinets have 3" stiles on frame.
- Be sure to confirm a heat shield is built into your appliance by the manufacturer or install the heat shield included with your appliance. Heat shields are sold separately as an accessory.
- Support shelf for oven not included; for built-in appliance support brackets, use OCINSTALLKIT (included in 24" deep cabinets).
- OCINSTALLKIT weight limit is 400 lbs. per pair.
- Oven cabinets feature an open back in cut-out area designed to improve field appliance installation.
- Maximum w/ Drawer cut-out dimension will allow 1/4" reveal for doors and drawer fronts on full overlay and 1" for partial overlay for trim kit face clearance.
- If the maximum height (as shown in gray) is cut out, the drawer will no longer be included. See chart below for maximum cut-out allowed if you want to keep the drawer.

	A Frame Opening Height	B Cut-out Width		C Cut-out Height			Door Height (Upper Section)	
		Min.	Max.	Min.	Max. Keeps Bottom Drawer	Max. Replaces Bottom Drawer	Partial Overlay	Full Overlay
OCD308424	15"	24"	28 1/2"	39"	54"	60"	16"	17 1/2"
OCD31.58424	15"	25 1/2"	30"	39"	54"	60"	16"	17 1/2"
OCD338424	15"	27"	31 1/2"	39"	54"	60"	16"	17 1/2"
OCD308724	18"	24"	28 1/2"	39"	54"	60"	19"	20 1/2"
OCD31.58724	18"	25 1/2"	30"	39"	54"	60"	19"	20 1/2"
OCD338724	18"	27"	31 1/2"	39"	54"	60"	19"	20 1/2"
OCD309024	21"	24"	28 1/2"	39"	54"	60"	22"	23 1/2"
OCD31.59024	21"	25 1/2"	30"	39"	54"	60"	22"	23 1/2"
OCD339024	21"	27"	31 1/2"	39"	54"	60"	22"	23 1/2"
OCD309324	24"	24"	28 1/2"	39"	54"	60"	25"	26 1/2"
OCD31.59324	24"	25 1/2"	30"	39"	54"	60"	25"	26 1/2"
OCD339324	24"	27"	31 1/2"	39"	54"	60"	25"	26 1/2"
OCD309624	27"	24"	28 1/2"	39"	54"	60"	28"	29 1/2"
OCD31.59624	27"	25 1/2"	30"	39"	54"	60"	28"	29 1/2"
OCD339624	27"	27"	31 1/2"	39"	54"	60"	28"	29 1/2"

Custom Modifications

AUTH	CBO	CCO	CFNTO	CFRMO	CND	FB	FD	FPEB	FTK	FTK_V	MIP	RD	RECTKL/R	RT	VTK
•	•	•		•	•	•	•	•	•	•	•	•	• ¹		• ¹

Construction Upgrades		Door Options			Non Soft-close Options	
APW	PLE	CG	CG.TOP	MFO	NSCFB	NSCH
•	•	•	•	•	•	•

¹ Only available on 84", 87", and 90" tall

DOUBLE OVEN CABINET NARROW RAIL, 84", 87", 90", 93", or 96" TALL, 24" DEEP

30", 31 1/2", or 33"

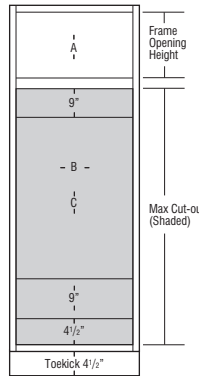
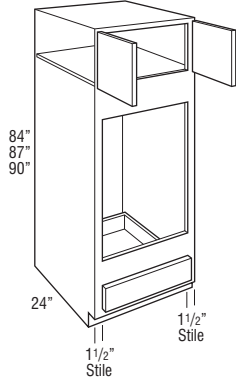

30", 31 1/2", or 33"

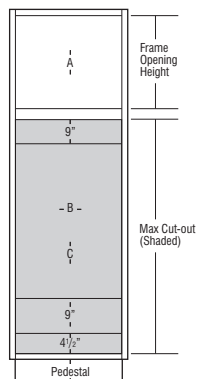
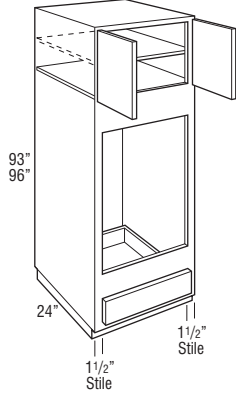

Price Point

OCD308424N	1446	1520	1675	1787	1932	2005	2043	2205	2249	2450	2649
OCD31.58424N	1496	1574	1733	1849	2000	2075	2115	2281	2327	2536	2742
OCD338424N	1546	1627	1790	1910	2067	2145	2187	2357	2405	2621	2835
OCD308724N	1546	1627	1788	1910	2067	2145	2187	2357	2405	2619	2834
OCD31.58724N	1598	1681	1849	1975	2137	2217	2260	2435	2484	2707	2929
OCD338724N	1650	1735	1909	2039	2206	2288	2332	2513	2563	2794	3023
OCD309024N	1572	1654	1818	1941	2102	2181	2221	2395	2443	2662	2881
OCD31.59024N	1624	1708	1879	2006	2171	2252	2295	2474	2523	2751	2976
OCD339024N	1676	1762	1940	2071	2239	2322	2368	2552	2603	2839	3070

OCD309324N	1698	1787	1965	2098	2268	2352	2397	2585	2638	2877	3113
OCD31.59324N	1751	1842	2027	2164	2340	2426	2473	2667	2721	2967	3209
OCD339324N	1803	1897	2089	2229	2411	2500	2548	2748	2804	3056	3304
OCD309624N	1698	1787	1965	2098	2268	2352	2397	2585	2638	2877	3113
OCD31.59624N	1751	1842	2027	2164	2340	2426	2473	2667	2721	2967	3209
OCD339624N	1803	1897	2089	2229	2411	2500	2548	2748	2804	3056	3304

- 90", 93", and 96" tall include full depth adjustable shelves in upper section:
90" and 93" tall - one shelf
96" tall - two shelves
- Oven cavity is standard interior.
- For built-in double oven applications, remove drawer as needed.
- All top and bottom cross rails are 1 1/2" wide.
- Be sure to confirm a heat shield is built into your appliance by the manufacturer or install the heat shield included with your appliance. Heat shields are sold separately as an accessory.
- Support shelf for oven not included; for built-in appliance support brackets, use OCINSTALLKIT (included in 24" deep cabinets).
- OCINSTALLKIT weight limit is 400 lbs. per pair.
- Oven cabinets feature an open back in cut-out area designed to improve field appliance installation.
- Maximum w/ Drawer cut-out dimension will allow 1/4" reveal for doors and drawer fronts on full overlay and 1" for partial overlay for trim kit face clearance.
- If the maximum height (as shown in gray) is cut out, the drawer will no longer be included. See chart below for maximum cut-out allowed if you want to keep the drawer.

	A Frame Opening Height	B Cut-out Width		C Cut-out Height			Door Height (Upper Section)	
		Min.	Max.	Min.	Max.		Partial Overlay	Full Overlay
					Keeps Bottom Drawer	Replaces Bottom Drawer		
OCD308424N	15"	27"	28 1/2"	39"	54"	60"	16"	17 1/2"
OCD31.58424N	15"	28 1/2"	30"	39"	54"	60"	16"	17 1/2"
OCD338424N	15"	30"	31 1/2"	39"	54"	60"	16"	17 1/2"
OCD308724N	18"	27"	28 1/2"	39"	54"	60"	19"	20 1/2"
OCD31.58724N	18"	28 1/2"	30"	39"	54"	60"	19"	20 1/2"
OCD338724N	18"	30"	31 1/2"	39"	54"	60"	19"	20 1/2"
OCD309024N	21"	27"	28 1/2"	39"	54"	60"	22"	23 1/2"
OCD31.59024N	21"	28 1/2"	30"	39"	54"	60"	22"	23 1/2"
OCD339024N	21"	30"	31 1/2"	39"	54"	60"	22"	23 1/2"
OCD309324N	24"	27"	28 1/2"	39"	54"	60"	25"	26 1/2"
OCD31.59324N	24"	28 1/2"	30"	39"	54"	60"	25"	26 1/2"
OCD339324N	24"	30"	31 1/2"	39"	54"	60"	25"	26 1/2"
OCD309624N	27"	27"	28 1/2"	39"	54"	60"	28"	29 1/2"
OCD31.59624N	27"	28 1/2"	30"	39"	54"	60"	28"	29 1/2"
OCD339624N	27"	30"	31 1/2"	39"	54"	60"	28"	29 1/2"

Custom Modifications

AUTH	CBO	CCO	CFNTO	CFRMO	CND	FB	FD	FPEB	FTK	FTK_V	MIP	RD	RECTKL/R	RT	VTK
•	•	•		•	•	•		•	•	•	•	•	• ¹		• ¹

Construction Upgrades

APW	PLE
•	•

Door Options

CG	CG.TOP	MFO
•		•

Non Soft-close Options

NSCFB	NSCH
•	•

¹ Only available on 84", 87", and 90" tall

DOUBLE OVEN CABINET, DEEP DRAWER, 84", 87", 90", 93", or 96" TALL, 24" DEEP

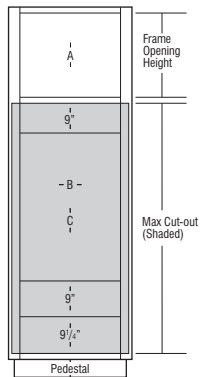
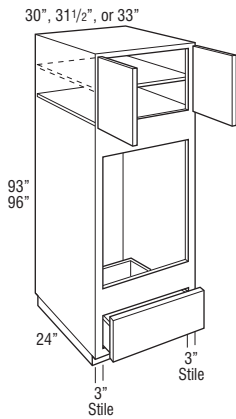
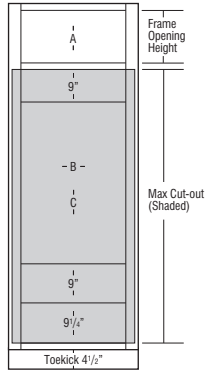
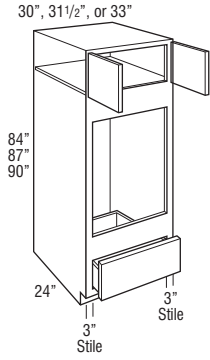

Price Point	1	2	3	4	5	6	7	8	9	10	11
OCD308424DD	1941	2009	2165	2266	2422	2499	2528	2690	2744	2934	3133
OCD31.58424DD	2054	2124	2285	2390	2552	2632	2661	2827	2884	3081	3288
OCD338424DD	2167	2239	2405	2513	2682	2765	2793	2964	3023	3227	3442
OCD308724DD	2042	2116	2279	2391	2557	2639	2671	2842	2899	3103	3319
OCD31.58724DD	2157	2232	2401	2516	2688	2773	2805	2981	3041	3252	3476
OCD338724DD	2271	2347	2523	2640	2818	2906	2938	3120	3182	3401	3632
OCD309024DD	2067	2142	2307	2421	2590	2674	2705	2880	2938	3145	3365
OCD31.59024DD	2182	2258	2430	2547	2722	2809	2840	3020	3081	3295	3522
OCD339024DD	2296	2374	2553	2672	2853	2943	2975	3159	3223	3444	3679

OCD309324DD	2193	2276	2453	2578	2757	2845	2882	3069	3131	3360	3597
OCD31.59324DD	2308	2393	2577	2704	2890	2983	3019	3212	3277	3512	3755
OCD339324DD	2423	2509	2701	2830	3023	3120	3156	3355	3422	3663	3912
OCD309624DD	2193	2276	2453	2578	2757	2845	2882	3069	3131	3360	3597
OCD31.59624DD	2308	2393	2577	2704	2890	2983	3019	3212	3277	3512	3755
OCD339624DD	2423	2509	2701	2830	3023	3120	3156	3355	3422	3663	3912

- Uses face mount hinges, doors and drawer fronts have a consistent width reveal for full overlay (1/4") and partial overlay (1").
- On 93" and 96" tall, one full depth shelf included, but packaged separately.
- All top and bottom cross rails are 1 1/2" wide.
- All cabinets have 3" stiles on frame.
- Be sure to confirm a heat shield is built into your appliance by the manufacturer or install the heat shield included with your appliance. Heat shields are sold separately as an accessory.
- For built-in appliance support, OCINSTALLKIT is included in 24" deep oven cabinets (see page 152 for details). Oven install kit will not be included when depth is modified.
- OCINSTALLKIT weight limit is 400 lbs. per pair.
- Oven cabinets feature an open back in cut-out area designed to improve field appliance installation.
- Maximum w/Drawer cut-out dimension will allow 1/4" reveal for doors and drawer fronts on full overlay and 1" for partial overlay for trim kit face clearance.
- If the maximum height (as shown in gray) is cut out, the drawer will no longer be included. See chart below for maximum cut-out allowed if you want to keep the drawer.

	A Frame Opening Height	B Cut-out Width		C Cut-out Height			Door Height (Upper Section)	
		Min.	Max.	Min.	Max. Keeps Bottom Drawer	Max. Replaces Bottom Drawer	Partial Overlay	Full Overlay
OCD308424DD	12"	24"	28 1/2"	37 1/4"	52 1/4"	63"	13"	14 1/2"
OCD31.58424DD	12"	25 1/2"	30"	37 1/4"	52 1/4"	63"	13"	14 1/2"
OCD338424DD	12"	27"	31 1/2"	37 1/4"	52 1/4"	63"	13"	14 1/2"
OCD308724DD	15"	24"	28 1/2"	37 1/4"	52 1/4"	63"	16"	17 1/2"
OCD31.58724DD	15"	25 1/2"	30"	37 1/4"	52 1/4"	63"	16"	17 1/2"
OCD338724DD	15"	27"	31 1/2"	37 1/4"	52 1/4"	63"	16"	17 1/2"
OCD309024DD	18"	24"	28 1/2"	37 1/4"	52 1/4"	63"	19"	20 1/2"
OCD31.59024DD	18"	25 1/2"	30"	37 1/4"	52 1/4"	63"	19"	20 1/2"
OCD339024DD	18"	27"	31 1/2"	37 1/4"	52 1/4"	63"	19"	20 1/2"
OCD309324DD	21"	24"	28 1/2"	37 1/4"	52 1/4"	63"	22"	23 1/2"
OCD31.59324DD	21"	25 1/2"	30"	37 1/4"	52 1/4"	63"	22"	23 1/2"
OCD339324DD	21"	27"	31 1/2"	37 1/4"	52 1/4"	63"	22"	23 1/2"
OCD309624DD	24"	24"	28 1/2"	37 1/4"	52 1/4"	63"	25"	26 1/2"
OCD31.59624DD	24"	25 1/2"	30"	37 1/4"	52 1/4"	63"	25"	26 1/2"
OCD339624DD	24"	27"	31 1/2"	37 1/4"	52 1/4"	63"	25"	26 1/2"

Custom Modifications

AUTH	CBO	CCO	CFNTO	CFRMO	CND	FB	FD	FPEB	FTK	FTK_V	MIP	RD	RECTKL/R	RT	VTK
•	•	•		•	•	•		•	•	•	•	•	• ¹		• ¹

Construction Upgrades

APW	PLE
•	•

Door Options

CG	CG.TOP	MFO
		•

Non Soft-close Options

NSCFB	NSCH
	•

¹ Only available on 84", 87", and 90" tall

DOUBLE OVEN CABINET, DEEP DRAWER, NARROW RAIL, 84", 87", 90", 93", or 96" TALL, 24" DEEP

30", 31 1/2", or 33"

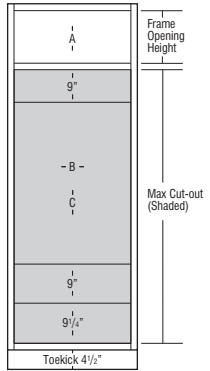
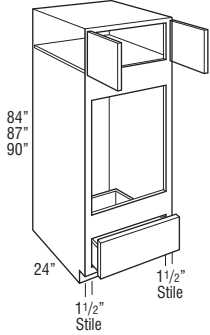

30", 31 1/2", or 33"

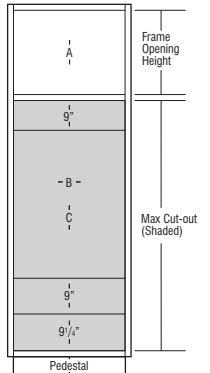
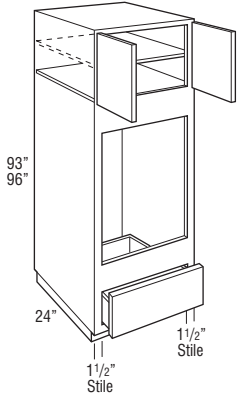

Price Point

	1	2	3	4	5	6	7	8	9	10	11
OCD308424DDN	1941	2009	2165	2266	2422	2499	2528	2690	2744	2934	3133
OCD31.58424DDN	2054	2124	2285	2390	2552	2632	2661	2827	2884	3081	3288
OCD338424DDN	2167	2239	2405	2513	2682	2765	2793	2964	3023	3227	3442
OCD308724DDN	2042	2116	2279	2391	2557	2639	2671	2842	2899	3103	3319
OCD31.58724DDN	2157	2232	2401	2516	2688	2773	2805	2981	3041	3252	3476
OCD338724DDN	2271	2347	2523	2640	2818	2906	2938	3120	3182	3401	3632
OCD309024DDN	2067	2142	2307	2421	2590	2674	2705	2880	2938	3145	3365
OCD31.59024DDN	2182	2258	2430	2547	2722	2809	2840	3020	3081	3295	3522
OCD339024DDN	2296	2374	2553	2672	2853	2943	2975	3159	3223	3444	3679

OCD309324DDN	2193	2276	2453	2578	2757	2845	2882	3069	3131	3360	3597
OCD31.59324DDN	2308	2393	2577	2704	2890	2983	3019	3212	3277	3512	3755
OCD339324DDN	2423	2509	2701	2830	3023	3120	3156	3355	3422	3663	3912
OCD309624DDN	2193	2276	2453	2578	2757	2845	2882	3069	3131	3360	3597
OCD31.59624DDN	2308	2393	2577	2704	2890	2983	3019	3212	3277	3512	3755
OCD339624DDN	2423	2509	2701	2830	3023	3120	3156	3355	3422	3663	3912

- On 93" and 96" tall, one full depth shelf included, but packaged separately.
- All top and bottom cross rails are 1 1/2" wide.
- Be sure to confirm a heat shield is built into your appliance by the manufacturer or install the heat shield included with your appliance. Heat shields are sold separately as an accessory.
- For built-in appliance support, OCINSTALKIT is included in 24" deep oven cabinets (see page 152 for details). Oven install kit will not be included when depth is modified.
- OCINSTALKIT weight limit is 400 lbs. per pair.
- Oven cabinets feature an open back in cut-out area designed to improve field appliance installation.
- Maximum w/ Drawer cut-out dimension will allow 1/4" reveal for doors and drawer fronts on full overlay and 1" for partial overlay for trim kit face clearance.
- If the maximum height (as shown in gray) is cut out, the drawer will no longer be included. See chart below for maximum cut-out allowed if you want to keep the drawer.

	A Frame Opening Height	B Cut-out Width		C Cut-out Height			Door Height (Upper Section)	
		Min.	Max.	Min.	Max.		Partial Overlay	Full Overlay
					Keeps Bottom Drawer	Replaces Bottom Drawer		
OCD308424DDN	12"	27"	28 1/2"	37 1/4"	52 1/4"	63"	13"	14 1/2"
OCD31.58424DDN	12"	28 1/2"	30"	37 1/4"	52 1/4"	63"	13"	14 1/2"
OCD338424DDN	12"	30"	31 1/2"	37 1/4"	52 1/4"	63"	13"	14 1/2"
OCD308724DDN	15"	27"	28 1/2"	37 1/4"	52 1/4"	63"	16"	17 1/2"
OCD31.58724DDN	15"	28 1/2"	30"	37 1/4"	52 1/4"	63"	16"	17 1/2"
OCD338724DDN	15"	30"	31 1/2"	37 1/4"	52 1/4"	63"	16"	17 1/2"
OCD309024DDN	18"	27"	28 1/2"	37 1/4"	52 1/4"	63"	19"	20 1/2"
OCD31.59024DDN	18"	28 1/2"	30"	37 1/4"	52 1/4"	63"	19"	20 1/2"
OCD339024DDN	18"	30"	31 1/2"	37 1/4"	52 1/4"	63"	19"	20 1/2"
OCD309324DDN	21"	27"	28 1/2"	37 1/4"	52 1/4"	63"	22"	23 1/2"
OCD31.59324DDN	21"	28 1/2"	30"	37 1/4"	52 1/4"	63"	22"	23 1/2"
OCD339324DDN	21"	30"	31 1/2"	37 1/4"	52 1/4"	63"	22"	23 1/2"
OCD309624DDN	24"	27"	28 1/2"	37 1/4"	52 1/4"	63"	25"	26 1/2"
OCD31.59624DDN	24"	28 1/2"	30"	37 1/4"	52 1/4"	63"	25"	26 1/2"
OCD339624DDN	24"	30"	31 1/2"	37 1/4"	52 1/4"	63"	25"	26 1/2"

Custom Modifications

AUTH	CBO	CCO	CFNT0	CFRMO	CND	FB	FD	FPEB	FTK	FTK_V	MIP	RD	RECTKL/R	RT	VTK
•	•	•		•	•	•	•	•	•	•	•	•	• ¹		• ¹

Construction Upgrades

APW	PLE
•	•

Door Options

CG	CG.TOP	MFO
•		•

Non Soft-close Options

NSCFB	NSCH
	•

¹ Only available on 84", 87", and 90" tall

**OVEN MICROWAVE CABINET,
DEEP DRAWER, 84", 87", 90",
93", or 96" TALL, 24" DEEP**

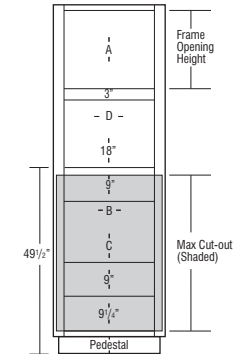
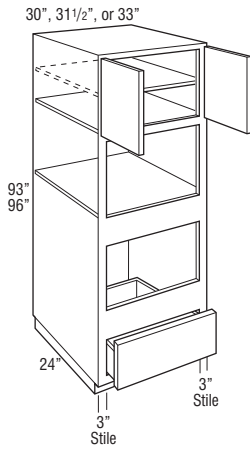
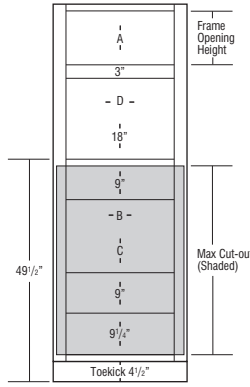
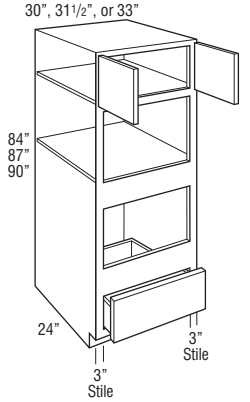

Price Point	1	2	3	4	5	6	7	8	9	10	11
OMC308424DD	2013	2085	2247	2356	2518	2599	2630	2797	2853	3057	3265
OMC31.58424DD	2129	2203	2371	2482	2652	2736	2767	2940	2999	3208	3424
OMC338424DD	2244	2320	2495	2608	2786	2873	2904	3082	3144	3359	3583
OMC308724DD	2117	2196	2368	2487	2660	2747	2780	2958	3018	3236	3461
OMC31.58724DD	2235	2315	2493	2614	2794	2884	2918	3102	3164	3390	3623
OMC338724DD	2352	2434	2617	2741	2928	3021	3055	3245	3310	3543	3784
OMC309024DD	2144	2223	2400	2519	2696	2784	2817	3000	3060	3281	3509
OMC31.59024DD	2262	2343	2524	2647	2831	2922	2955	3144	3207	3435	3672
OMC339024DD	2380	2462	2648	2774	2965	3059	3093	3287	3353	3589	3834
OMC309324DD	2277	2364	2551	2681	2871	2965	3001	3200	3265	3505	3751
OMC31.59324DD	2396	2483	2678	2812	3008	3105	3143	3345	3413	3660	3914
OMC339324DD	2515	2602	2805	2942	3144	3244	3284	3490	3561	3814	4076
OMC309624DD	2277	2364	2551	2681	2871	2965	3001	3200	3265	3505	3751
OMC31.59624DD	2396	2483	2678	2812	3008	3105	3143	3345	3413	3660	3914
OMC339624DD	2515	2602	2805	2942	3144	3244	3284	3490	3561	3814	4076

- Designed for use with separate built-in microwave above, built-in oven below. For built-in double ovens, see pages 99-102.
- On 93" and 96" tall, one full depth shelf included, but packaged separately.
- Uses face mount hinges, doors and drawer fronts have a consistent width reveal for full overlay (1/4") and partial overlay (1").
- All top and bottom cross rails are 1 1/2" wide.
- All cabinets have 3" stiles on frame.
- Be sure to confirm a heat shield is built into your appliance by the manufacturer or install the heat shield included with your appliance. Heat shields are sold separately as an accessory.
- For built-in appliance support, OCINSTALLKIT is included in 24" deep oven cabinets (see page 152 for details). Oven install kit will not be included when depth is modified.
- OCINSTALLKIT weight limit is 400 lbs. per pair.
- Maximum w/ Drawer cut-out dimension will allow 1/4" reveal for doors and drawer fronts on full overlay and 1" for partial overlay for trim kit face clearance.
- Oven cabinet cut-out is shaded in gray and is cut out on job site.
- If the maximum height (as shown in gray) is cut out, the drawer will no longer be included. See chart below for maximum cut-out allowed if you want to keep the drawer.

	A Frame Opening Height	B/D Cut-out Width		C Cut-out Height			Door Height (Upper Section)	
		Min.	Max.	Min.	Max. Keeps Bottom Drawer	Max. Replaces Bottom Drawer	Partial Overlay	Full Overlay
OMC308424DD	12"	24"	28 1/2"	16 1/4"	31 1/4"	42"	13"	14 1/2"
OMC31.58424DD	12"	25 1/2"	30"	16 1/4"	31 1/4"	42"	13"	14 1/2"
OMC338424DD	12"	27"	31 1/2"	16 1/4"	31 1/4"	42"	13"	14 1/2"
OMC308724DD	15"	24"	28 1/2"	16 1/4"	31 1/4"	42"	16"	17 1/2"
OMC31.58724DD	15"	25 1/2"	30"	16 1/4"	31 1/4"	42"	16"	17 1/2"
OMC338724DD	15"	27"	31 1/2"	16 1/4"	31 1/4"	42"	16"	17 1/2"
OMC309024DD	18"	24"	28 1/2"	16 1/4"	31 1/4"	42"	19"	20 1/2"
OMC31.59024DD	18"	25 1/2"	30"	16 1/4"	31 1/4"	42"	19"	20 1/2"
OMC339024DD	18"	27"	31 1/2"	16 1/4"	31 1/4"	42"	19"	20 1/2"
OMC309324DD	21"	24"	28 1/2"	16 1/4"	31 1/4"	42"	22"	23 1/2"
OMC31.59324DD	21"	25 1/2"	30"	16 1/4"	31 1/4"	42"	22"	23 1/2"
OMC339324DD	21"	27"	31 1/2"	16 1/4"	31 1/4"	42"	22"	23 1/2"
OMC309624DD	24"	24"	28 1/2"	16 1/4"	31 1/4"	42"	25"	26 1/2"
OMC31.59624DD	24"	25 1/2"	30"	16 1/4"	31 1/4"	42"	25"	26 1/2"
OMC339624DD	24"	27"	31 1/2"	16 1/4"	31 1/4"	42"	25"	26 1/2"

Custom Modifications

AUTH	CBO	CCO	CFNTO	CFRMO	CND	FB	FD	FPEB	FTK	FTK_V	MIP	RD	RECTKL/R	RT	VTK
•	•	•		•	•	•	•	•	•	•	•	•	• ¹		• ¹

Construction Upgrades

APW	PLE
•	•

Door Options

CG	CG.TOP	MFO
		•

Non Soft-close Options

NSCFB	NSCH
	•

¹ Only available on 84", 87", and 90" tall

OVEN MICROWAVE CABINET, DEEP DRAWER, NARROW RAIL, 84", 87", 90", 93", or 96" TALL, 24" DEEP

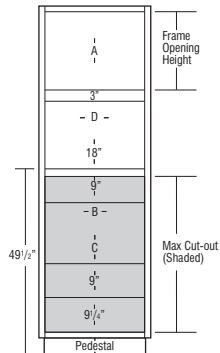
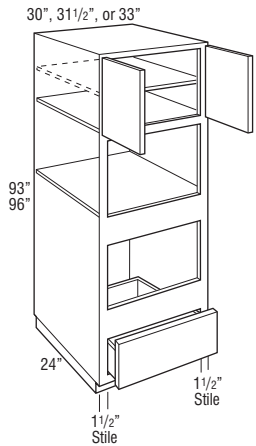
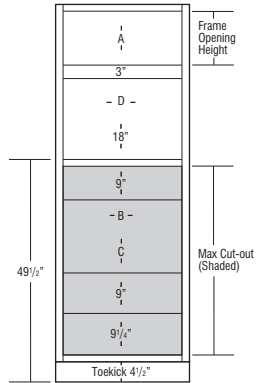
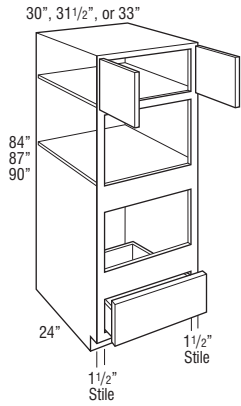

Price Point	1	2	3	4	5	6	7	8	9	10	11
OMC308424DDN	2013	2085	2247	2356	2518	2599	2630	2797	2853	3057	3265
OMC31.58424DDN	2129	2203	2371	2482	2652	2736	2767	2940	2999	3208	3424
OMC338424DDN	2244	2320	2495	2608	2786	2873	2904	3082	3144	3359	3583
OMC308724DDN	2117	2196	2368	2487	2660	2747	2780	2958	3018	3236	3461
OMC31.58724DDN	2235	2315	2493	2614	2794	2884	2918	3102	3164	3390	3623
OMC338724DDN	2352	2434	2617	2741	2928	3021	3055	3245	3310	3543	3784
OMC309024DDN	2144	2223	2400	2519	2696	2784	2817	3000	3060	3281	3509
OMC31.59024DDN	2262	2343	2524	2647	2831	2922	2955	3144	3207	3435	3672
OMC339024DDN	2380	2462	2648	2774	2965	3059	3093	3287	3353	3589	3834

OMC309324DDN	2277	2364	2551	2681	2871	2965	3001	3200	3265	3505	3751
OMC31.59324DDN	2396	2483	2678	2812	3008	3105	3143	3345	3413	3660	3914
OMC339324DDN	2515	2602	2805	2942	3144	3244	3284	3490	3561	3814	4076
OMC309624DDN	2277	2364	2551	2681	2871	2965	3001	3200	3265	3505	3751
OMC31.59624DDN	2396	2483	2678	2812	3008	3105	3143	3345	3413	3660	3914
OMC339624DDN	2515	2602	2805	2942	3144	3244	3284	3490	3561	3814	4076

- Designed for use with separate built-in microwave above, built-in oven below. For built-in double ovens, see pages 99-102.
- On 93" and 96" tall, one full depth shelf included, but packaged separately.
- All top and bottom cross rails are 1 1/2" wide.
- Be sure to confirm a heat shield is built into your appliance by the manufacturer or install the heat shield included with your appliance. Heat shields are sold separately as an accessory.
- For built-in appliance support, OCINSTALLKIT is included in 24" deep oven cabinets (see page 152 for details). Oven install kit will not be included when depth is modified.
- OCINSTALLKIT weight limit is 400 lbs. per pair.
- Maximum w/ Drawer cut-out dimension will allow 1/4" reveal for doors and drawer fronts on full overlay and 1" for partial overlay for trim kit face clearance.
- Oven cabinet cut-out is shaded in gray and is cut out on job site.
- If the maximum height (as shown in gray) is cut out, the drawer will no longer be included. See chart below for maximum cut-out allowed if you want to keep the drawer.

	A Frame Opening Height	B/D Cut-out Width		C Cut-out Height			Door Height (Upper Section)	
		Min.	Max.	Min.	Max.		Partial Overlay	Full Overlay
					Keeps Bottom Drawer	Replaces Bottom Drawer		
OMC308424DDN	12"	27"	28 1/2"	16 1/4"	31 1/4"	42"	13"	14 1/2"
OMC31.58424DDN	12"	28 1/2"	30"	16 1/4"	31 1/4"	42"	13"	14 1/2"
OMC338424DDN	12"	30"	31 1/2"	16 1/4"	31 1/4"	42"	13"	14 1/2"
OMC308724DDN	15"	27"	28 1/2"	16 1/4"	31 1/4"	42"	16"	17 1/2"
OMC31.58724DDN	15"	28 1/2"	30"	16 1/4"	31 1/4"	42"	16"	17 1/2"
OMC338724DDN	15"	30"	31 1/2"	16 1/4"	31 1/4"	42"	16"	17 1/2"
OMC309024DDN	18"	27"	28 1/2"	16 1/4"	31 1/4"	42"	19"	20 1/2"
OMC31.59024DDN	18"	28 1/2"	30"	16 1/4"	31 1/4"	42"	19"	20 1/2"
OMC339024DDN	18"	30"	31 1/2"	16 1/4"	31 1/4"	42"	19"	20 1/2"
OMC309324DDN	21"	27"	28 1/2"	16 1/4"	31 1/4"	42"	22"	23 1/2"
OMC31.59324DDN	21"	28 1/2"	30"	16 1/4"	31 1/4"	42"	22"	23 1/2"
OMC339324DDN	21"	30"	31 1/2"	16 1/4"	31 1/4"	42"	22"	23 1/2"
OMC309624DDN	24"	27"	28 1/2"	16 1/4"	31 1/4"	42"	25"	26 1/2"
OMC31.59624DDN	24"	28 1/2"	30"	16 1/4"	31 1/4"	42"	25"	26 1/2"
OMC339624DDN	24"	30"	31 1/2"	16 1/4"	31 1/4"	42"	25"	26 1/2"

Custom Modifications

AUTH	CBO	CCO	CFNTO	CFRMO	CND	FB	FD	FPEB	FTK	FTK_V	MIP	RD	RECTKL/R	RT	VTK
•	•	•		•	•	•		•	•	•	•	•	• ¹		• ¹

Construction Upgrades

APW	PLE
•	•

Door Options

CG	CG.TOP	MFO
•		•

Non Soft-close Options

NSCFB	NSCH
	•

¹ Only available on 84", 87", and 90" tall

TABLE OF CONTENTS – OFFICE & FURNITURE CABINETS

Wall Furniture Bookcase Cabinets	106
Tall Bookcase Cabinets	107
Desk Base Cabinets	108
Desk Three Drawer Base Cabinets	108
Desk Organization and Specialty Cabinets	108
Under Counter Drawers and Furniture Drawers	109

OFFICE & FURNITURE CABINET NOMENCLATURE



CONSTRUCTION UPGRADES

Mod.	Description
APW	All- plywood Construction
PLE	Plywood Ends

NON SOFT-CLOSE OPTIONS

Mod.	Description
NSCFB	Non Soft- close Guides & Furniture Board Drawers and Roll Trays
NSCH	Non Soft-close Door Hinges

MODIFICATIONS GRID KEY

Mod.	Description
•	Available
STD	Standard on these cabinets

CUSTOM MODIFICATIONS

Mod.	Description
ADDTK	Add Toekick
AUTHB	Authentic End - Both
AUTHL	Authentic End - Left
AUTHR	Authentic End - Right
CBO	Cabinet Box Only
CCO	Cabinet Case Only
CFNTO	Cabinet Front Only
CFP	Cabinet False Panel
CFRMO	Cabinet Frame Only
CND	Cabinet with No Door, with Drawer
FB	Finished Ends
FPEB	Furniture Finished Plywood End Panels
FTK	Flush Toekick
FTKAV	Flush Toekick Arch
FTKfV	Flush Toekick Furniture
ID	Increased Depth
MIP	Matching Interior Plywood
RD	Reduced Depth
RECTKBK	Recessed Toekick Back
RECTKL	Recessed Toekick Left
RECTKR	Recessed Toekick Right
RT	Installed Roll Tray
VTK	Void Toekick

All office cabinets are predrilled for full depth shelves or roll trays.

Standard toekick height is 4 1/2" tall, which will align with standard base cabinets.

WALL FURNITURE BOOKCASE, 48", 51", 54", 57", 60", or 66" HIGH, 12" DEEP

18", 24", 30", or 36"

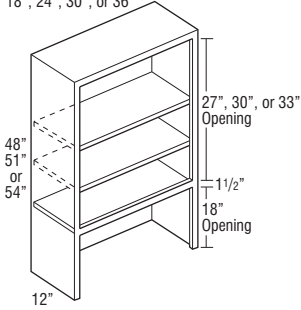

18", 24", 30", or 36"

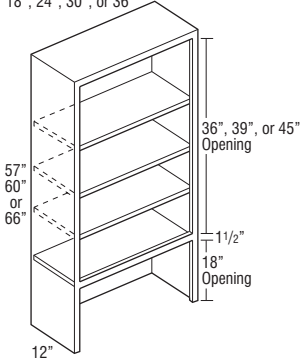

Price Point

	1	2	3	4	5	6	7	8	9	10	11
WFBC1848	723	723	723	723	723	723	723	723	723	723	723
WFBC2448	879	879	879	879	879	879	879	879	879	879	879
WFBC3048	967	967	967	967	967	967	967	967	967	967	967
WFBC3648	1028	1028	1028	1028	1028	1028	1028	1028	1028	1028	1028
WFBC1851	770	770	770	770	770	770	770	770	770	770	770
WFBC2451	936	936	936	936	936	936	936	936	936	936	936
WFBC3051	1030	1030	1030	1030	1030	1030	1030	1030	1030	1030	1030
WFBC3651	1095	1095	1095	1095	1095	1095	1095	1095	1095	1095	1095
WFBC1854	781	781	781	781	781	781	781	781	781	781	781
WFBC2454	950	950	950	950	950	950	950	950	950	950	950
WFBC3054	1045	1045	1045	1045	1045	1045	1045	1045	1045	1045	1045
WFBC3654	1110	1110	1110	1110	1110	1110	1110	1110	1110	1110	1110

WFBC1857	867	867	867	867	867	867	867	867	867	867	867
WFBC2457	1053	1053	1053	1053	1053	1053	1053	1053	1053	1053	1053
WFBC3057	1161	1161	1161	1161	1161	1161	1161	1161	1161	1161	1161
WFBC3657	1231	1231	1231	1231	1231	1231	1231	1231	1231	1231	1231
WFBC1860	867	867	867	867	867	867	867	867	867	867	867
WFBC2460	1053	1053	1053	1053	1053	1053	1053	1053	1053	1053	1053
WFBC3060	1161	1161	1161	1161	1161	1161	1161	1161	1161	1161	1161
WFBC3660	1231	1231	1231	1231	1231	1231	1231	1231	1231	1231	1231
WFBC1866	955	955	955	955	955	955	955	955	955	955	955
WFBC2466	1161	1161	1161	1161	1161	1161	1161	1161	1161	1161	1161
WFBC3066	1277	1277	1277	1277	1277	1277	1277	1277	1277	1277	1277
WFBC3666	1356	1356	1356	1356	1356	1356	1356	1356	1356	1356	1356

- 48", 51", and 54" have two adjustable shelves and one fixed shelf.
- 57", 60", and 66" have three adjustable shelves and one fixed shelf.
- Ends, tops, bottoms, and backs are veneer plywood.
- Depth can be reduced to a minimum of 9" and increased to a maximum of 15".

Custom Modifications

ADDTK	AUTH	CBO	CCO	CFNTO	CFP	CFRMO	CND	FB	FPEB	FTK	FTK_V	ID	MIP	RD	RECTKBK	RECTKL/R	RT	VTK	
	• ¹	STD																	

Construction Upgrades

APW	PLE

Non Soft-close Options

NSCFB	NSCH

¹ Not available on 66" high

TALL BOOKCASE, 84", 87", 90", 93", or 96" HIGH, 12" DEEP

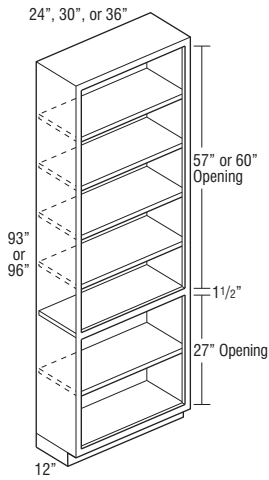
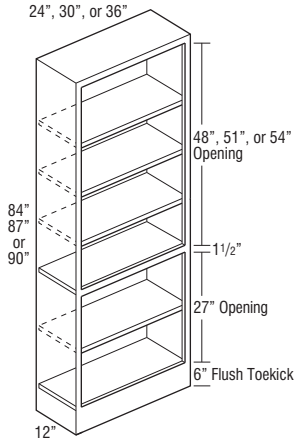

Price Point	1	2	3	4	5	6	7	8	9	10	11
TBC248412	1724	1724	1724	1724	1724	1724	1724	1724	1724	1724	1724
TBC308412	1915	1915	1915	1915	1915	1915	1915	1915	1915	1915	1915
TBC368412	2037	2037	2037	2037	2037	2037	2037	2037	2037	2037	2037
TBC248712	1766	1766	1766	1766	1766	1766	1766	1766	1766	1766	1766
TBC308712	1958	1958	1958	1958	1958	1958	1958	1958	1958	1958	1958
TBC368712	2084	2084	2084	2084	2084	2084	2084	2084	2084	2084	2084
TBC249012	1775	1775	1775	1775	1775	1775	1775	1775	1775	1775	1775
TBC309012	1968	1968	1968	1968	1968	1968	1968	1968	1968	1968	1968
TBC369012	2097	2097	2097	2097	2097	2097	2097	2097	2097	2097	2097

TBC249312	1828	1828	1828	1828	1828	1828	1828	1828	1828	1828	1828
TBC309312	2029	2029	2029	2029	2029	2029	2029	2029	2029	2029	2029
TBC369312	2159	2159	2159	2159	2159	2159	2159	2159	2159	2159	2159
TBC249612	1828	1828	1828	1828	1828	1828	1828	1828	1828	1828	1828
TBC309612	2029	2029	2029	2029	2029	2029	2029	2029	2029	2029	2029
TBC369612	2159	2159	2159	2159	2159	2159	2159	2159	2159	2159	2159

- 84" and 87" tall include four adjustable shelves and one fixed shelf.
- 90" and 93" tall includes five adjustable shelves and one fixed shelf.
- 96" tall includes six adjustable shelves and one fixed shelf.
- Ends, tops, bottoms, and backs are veneer plywood.
- Separate pedestal base included but shipped separately on 93" and 96" Tall.
- Bookcases can only be reduced to 9".

Custom Modifications

ADDTK	AUTH	CBO	CCO	CFNTO	CFP	CFRMO	CND	FB	FPEB	FTK	FTK_V	ID	MIP	RD	RECTKBK	RECTKL/R	RT	VTK	
			STD								• ¹			STD					

Construction Upgrades

APW	PLE

Non Soft-close Options

NSCFB	NSCH

¹ Standard on 84", 87", and 90" high. Optional on 93" and 96" high

DESK DOOR DRAWER BASE, 29" HIGH, 21" DEEP

12", 15", 18", or 21"

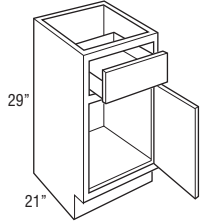

24", 30", or 36"

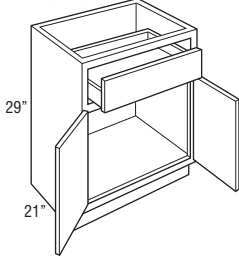

	Price Point	1	2	3	4	5	6	7	8	9	10	11
DDO122921 L or R		503	529	585	623	675	700	714	767	782	853	923
DDO152921 L or R		537	565	620	662	716	743	758	816	833	908	982
DDO182921 L or R		571	599	660	706	764	792	807	870	888	967	1045
DDO212921 L or R		609	639	704	752	812	843	860	929	948	1029	1113

DDO242921	671	704	774	827	894	928	946	1020	1041	1133	1211
DDO302921	784	825	910	970	1050	1089	1107	1198	1222	1375	1424
DDO362921	986	1036	1142	1218	1316	1365	1392	1501	1532	1736	1810

• Depth on 21" deep can be increased to a maximum of 24".

Custom Modifications

ADDTK	AUTH	CBO	CCO	CFNTD	CFP	CFRMO	CND	FB	FPEB	FTK	FTK_V	ID	MIP	RD	RECTKBK	RECTKL/R	RT	VTK
			•	•	•	•	•	•	•	•	• ¹	•	•	•	•	•	•	•

Construction Upgrades

APW	PLE
•	•

Non Soft-close Options

NSCFB	NSCH
•	•

¹ Not available on 12" wide

DESK THREE DRAWER BASE, 29" HIGH, 21" DEEP

12", 15", 18", 21", or 24"

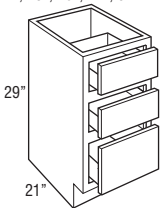

3DB122921	638	655	694	715	755	776	780	816	833	870	912
3DB152921	686	704	745	771	815	836	838	877	895	936	982
3DB182921	737	758	804	829	877	901	904	946	965	1010	1059
3DB212921	787	808	856	885	935	959	964	1008	1029	1075	1128
3DB242921	844	866	919	947	1002	1029	1032	1081	1104	1153	1209

Custom Modifications

ADDTK	AUTH	CBO	CCO	CFNTD	CFP	CFRMO	CND	FB	FPEB	FTK	FTK_V	ID	MIP	RD	RECTKBK	RECTKL/R	RT	VTK
			•	•	•	•	•	•	•	•	• ¹	•	•	•	•	•	•	•

Construction Upgrades

APW	PLE
•	•

Non Soft-close Options

NSCFB	NSCH
•	•

¹ Not available on 12" wide

DESK FILE DRAWER BASE, 29" HIGH, 21" DEEP

15", 18", or 21"

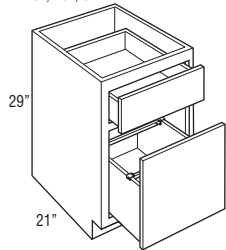

DFD152921	892	922	997	1042	1118	1156	1176	1258	1284	1446	1490
DFD182921	935	966	1051	1096	1176	1216	1237	1323	1350	1524	1570
DFD212921	989	1024	1110	1161	1247	1290	1315	1406	1435	1618	1668

- Door is attached to file drawer.
- Includes Filing System Hardware Kit, which accommodates letter and legal filing.
- Exterior height of file drawer is 10".

Custom Modifications

ADDTK	AUTH	CBO	CCO	CFNTD	CFP	CFRMO	CND	FB	FPEB	FTK	FTK_V	ID	MIP	RD	RECTKBK	RECTKL/R	RT	VTK
			•	•	•	•	•	•	•	•	•	•	•	•	•	•	•	•

Construction Upgrades

APW	PLE
•	•

Non Soft-close Options

NSCFB	NSCH

DESK DOUBLE FILE DRAWER BASE, 29" HIGH, 21" DEEP

24" or 30"

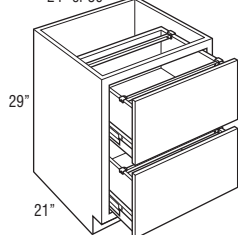

DDFD242921	1160	1199	1299	1360	1461	1510	1537	1644	1677	1893	1950
DDFD302921	1273	1316	1427	1496	1607	1661	1692	1808	1845	2083	2146

- Includes Filing System Hardware Kit, which accommodates letter and legal filing.
- Drawers utilize 125 lb. full extension progressive side-mount guide, does not feature soft-close guide.
- Bottom of drawer is not designed to support any weight.
- Exterior height of drawer box is 9 1/2".

Custom Modifications

ADDTK	AUTH	CBO	CCO	CFNTD	CFP	CFRMO	CND	FB	FPEB	FTK	FTK_V	ID	MIP	RD	RECTKBK	RECTKL/R	RT	VTK
			•	•	•	•	•	•	•	•	•	•	•	•	•	•	•	•

Construction Upgrades

APW	PLE
•	•

Non Soft-close Options

NSCFB	NSCH

UNDER COUNTER DRAWER, 4 3/4" HIGH, 21" DEEP

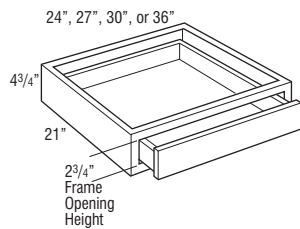

Price Point	1	2	3	4	5	6	7	8	9	10	11
UCD2421	416	425	445	456	476	487	491	492	515	538	559
UCD2721	438	446	470	480	501	512	517	537	543	566	590
UCDS3021	455	465	488	500	521	532	538	558	564	588	613
UCDS3621	511	521	547	559	584	596	602	627	632	660	688

- Cabinet is 4 3/4" high. Drawer box within cabinet is 2" high (outside dimension).
- Not trimmable.
- Drawer front is 3/4" slab for all styles. Slab drawer fronts on certain laminate door styles will be painted hardwood. See Door Style section for exceptions.
- The frame to end panel offset is 3/4", which is designed to accommodate the vanity desk leg.
- Plywood end panels are unfinished.

Custom Modifications

ADDTK	AUTH	CBO	CCO	CFNTO	CFP	CFRMO	CND	FB	FPEB	FTK	FTK_V	ID	MIP	RD	RECTKBK	RECTKL/R	RT	VTK
		•	•			•						•		•				

Construction Upgrades

APW	PLE
•	STD

Non Soft-close Options

NSCFB	NSCH

UNDER COUNTER DRAWER, TRIMMABLE, 4 3/4" HIGH, 21" DEEP

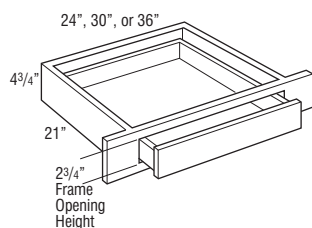

UCDT2421	416	425	445	456	476	487	491	492	515	538	559
UCDT3021	455	465	488	500	521	532	538	558	564	588	613
UCDT3621	511	521	547	559	584	596	602	627	632	660	688

- Cabinet is 4 3/4" high. Drawer box within cabinet is 2" high (outside dimension).
- Frame stile is trimmable 3" on each side, which leaves a face frame to end panel offset of 3/4" to accommodate the vanity desk leg.
- Drawer front is 3/4" slab for all styles. Slab drawer fronts on certain laminate door styles will be painted hardwood. See Door Style section for exceptions.
- Plywood end panels are unfinished.

Custom Modifications

ADDTK	AUTH	CBO	CCO	CFNTO	CFP	CFRMO	CND	FB	FPEB	FTK	FTK_V	ID	MIP	RD	RECTKBK	RECTKL/R	RT	VTK
		•	•			•						•		•				

Construction Upgrades

APW	PLE
•	STD

Non Soft-close Options

NSCFB	NSCH

FURNITURE DRAWER, 6 3/4" HIGH, 24" DEEP

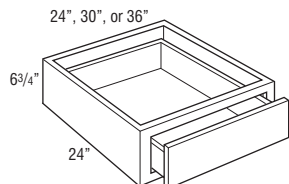

FD2406.7524	426	435	456	466	487	497	503	523	528	550	573
FD3006.7524	633	639	642	665	678	685	706	727	769	800	829
FD3606.7524	674	685	704	729	752	763	779	808	815	847	878

- On partial overlay styles, drawer front to face frame is justified to the top to be consistent with current partial overlay reveal. Bottom reveal is 1/4".
- Exterior height of drawer box is 3 3/8".

Custom Modifications

ADDTK	AUTH	CBO	CCO	CFNTO	CFP	CFRMO	CND	FB	FPEB	FTK	FTK_V	ID	MIP	RD	RECTKBK	RECTKL/R	RT	VTK
		•	•			•		•	•					•				

Construction Upgrades

APW	PLE
•	•

Non Soft-close Options

NSCFB	NSCH

FURNITURE DRAWER, 12" HIGH, 24" DEEP

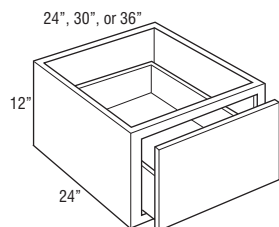

FD241224	556	566	591	605	627	639	645	667	674	701	725
FD301224	753	756	760	788	807	816	845	873	918	954	989
FD361224	801	814	833	868	895	907	927	960	967	1007	1044

- Drawer front to face frame reveal is justified to the bottom to be consistent with both full overlay and partial overlay. Top reveal is 1 1/8" for partial overlay and 3/8" for full overlay. Bottom reveal is 1" for partial overlay and 1/4" for full overlay.
- Exterior height of drawer box is 6 3/8".

Custom Modifications

ADDTK	AUTH	CBO	CCO	CFNTO	CFP	CFRMO	CND	FB	FPEB	FTK	FTK_V	ID	MIP	RD	RECTKBK	RECTKL/R	RT	VTK
•		•	•			•		•	•					•				

Construction Upgrades

APW	PLE
•	•

Non Soft-close Options

NSCFB	NSCH

FURNITURE DRAWER WINDOW BENCH, 18" HIGH, 24" DEEP

15", 18", 21", 24", 27", 30", 33", or 36"

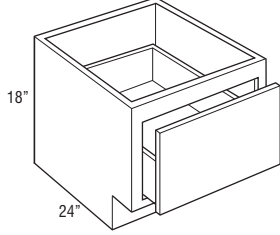

Price Point	1	2	3	4	5	6	7	8	9	10	11
FDWB151824	703	705	707	721	731	735	750	764	794	840	861
FDWB181824	740	743	746	763	775	779	795	811	843	885	910
FDWB211824	754	762	789	799	814	822	843	865	871	897	924
FDWB241824	765	775	799	808	835	847	854	877	884	911	936
FDWB271824	786	795	821	831	858	871	877	901	907	935	963
FDWB301824	971	972	977	1005	1022	1031	1058	1085	1126	1164	1195
FDWB331824	1007	1014	1017	1055	1073	1082	1113	1142	1166	1204	1237
FDWB361824	1044	1055	1058	1105	1123	1132	1166	1198	1206	1244	1279

- Drawer front to face frame reveal is justified to the bottom to be consistent with both full overlay and partial overlay. Partial overlay top reveal is 2 5/8" and bottom reveal is 1". Full overlay top reveal is 1 7/8" and bottom reveal is 1/4".
- Exterior height of drawer box is 6 3/8".

Custom Modifications

ADDTK	AUTH	CBO	CCO	CFNTO	CFP	CFRMO	CND	FB	FPEB	FTK	FTK_V	ID	MIP	RD	RECTKBK	RECTKL/R	RT	VTK
		•	•			•		•	•	•	•			•	•	•		•

Construction Upgrades

APW	PLE
•	•

Non Soft-close Options

NSCFB	NSCH

TABLE OF CONTENTS – VANITY CABINETS

False Panel Vanity Sink Bases	112
Vanity Base Cabinets	113
Vanity Drawer Base Cabinets	114
Vanity Tall Cabinets	121
Vanity Wall Cabinets and Mirrors	121

VANITY CABINET NOMENCLATURE

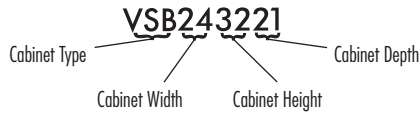

DOOR OPTIONS

Mod.	Description
CG	Cut-for- glass Doors
MD	Mullion Doors
MFO	Modified Full Overlay

CONSTRUCTION UPGRADES

Mod.	Description
APW	All- plywood Construction
PLE	Plywood Ends

NON SOFT-CLOSE OPTIONS

Mod.	Description
NSCFB	Non Soft- close Guides & Furniture Board Drawers and Roll Trays
NSCH	Non Soft-close Door Hinges

MODIFICATIONS GRID KEY

Mod.	Description
•	Available
STD	Standard on these cabinets

CUSTOM MODIFICATIONS

Mod.	Description
AUTHB	Authentic End - Both
AUTHL	Authentic End - Left
AUTHR	Authentic End - Right
CBO	Cabinet Box Only
CCO	Cabinet Case Only
CFNTO	Cabinet Front Only
CFP	Cabinet False Panel
CFRMO	Cabinet Frame Only
FB	Finished Ends
FPEB	Furniture Finished Plywood End Panels
FTK	Flush Toekick
FTKAV	Flush Toekick Arch
FTKFV	Flush Toekick Furniture
ID	Increased Depth
MIP	Matching Interior Plywood
RD	Reduced Depth
RECTKBK	Recessed Toekick Back
RECTKL	Recessed Toekick Left
RECTKR	Recessed Toekick Right
RT	Installed Roll Tray
VTK	Void Toekick

Vanity Cabinets are shipped with an unfinished toekick. Finished toekicks in matching wood veneer or laminate must be ordered separately and field installed.

Standard vanity toekick height is 4 1/2" tall, which will align with standard base cabinets.

Distance between back of drawer box and back interior of cabinet is 2 3/4".

There will be no charge for RD18 on 21" deep vanity cabinets.

For Linen cabinets, Tall mitered door styles and laminate door styles will feature one center panel, other door styles will feature two center panels.

VANITY SINK BASE with FALSE PANEL, 32" HIGH

24", 27", 30", 33", or 36"

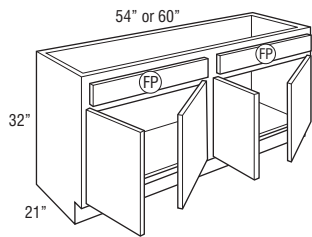
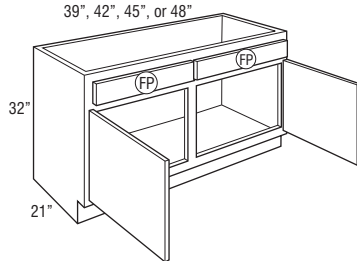
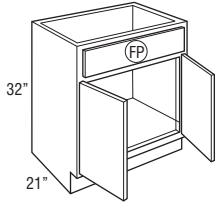

FP = False Panel

Price Point

	1	2	3	4	5	6	7	8	9	10	11
VS B243221	593	623	685	727	789	819	835	901	920	1002	1081
VS B273221	608	639	703	751	812	843	860	926	945	1028	1112
VS B303221	628	661	728	777	842	874	890	957	977	1067	1155
VS B333221	656	689	759	809	875	908	926	996	1016	1110	1199
VS B363221	681	716	789	842	911	946	964	1041	1062	1155	1250

VS B393221	711	746	824	879	950	986	1005	1085	1107	1203	1302
VS B423221	739	777	855	913	988	1025	1045	1128	1152	1252	1352
VS B453221	777	818	896	959	1036	1075	1097	1184	1209	1315	1420
VS B483221CS	849	895	988	1058	1146	1190	1213	1309	1336	1460	1581

VS B543221	967	1016	1120	1197	1294	1342	1367	1473	1504	1638	1771
VS B603221	1063	1118	1232	1316	1423	1476	1504	1621	1654	1801	1948

Custom Modifications

AUTH	CBO	CCO	CFNTO	CFP	CFRMO	FB	FPEB	FTK	FTK_V	ID	MIP	RD	RECTKBK	RECTKL/R	RT	VTK
•		•	•	•	STD	•	•	•	•	•	•	•	•	•	•	•

Construction Upgrades

APW	PLE
•	•

Door Options

CG	MD	MFO

Non Soft-close Options

NSCFB	NSCH
	•

VANITY SINK BASE with FALSE PANEL, 34 1/2" HIGH

24", 27", 30", 33", or 36"

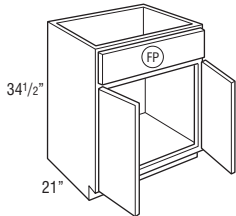

39", 42", 45", or 48"

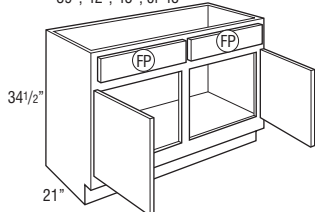

54" or 60"

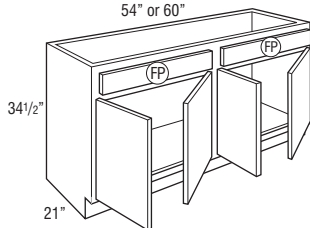

FP = False Panel

Price Point

	1	2	3	4	5	6	7	8	9	10	11
VSB243421	678	713	786	837	907	940	956	1031	1052	1147	1219
VSB273421	683	721	789	843	912	946	964	1041	1062	1157	1250
VSB303421	706	744	819	872	944	979	997	1076	1098	1198	1294
VSB333421	733	768	848	903	977	1014	1032	1116	1138	1239	1342
VSB363421	762	800	882	942	1019	1056	1078	1161	1184	1290	1396

VSB393421	800	840	927	991	1070	1109	1132	1219	1244	1355	1465
VSB423421	837	881	970	1035	1119	1161	1185	1276	1302	1417	1536
VSB453421	879	924	1022	1088	1178	1221	1243	1339	1366	1489	1611
VSB483421CS	952	1004	1110	1189	1287	1336	1362	1470	1500	1638	1742

VSB543421	1082	1140	1256	1339	1449	1504	1530	1650	1684	1834	1984
VSB603421	1191	1254	1381	1473	1593	1652	1684	1816	1853	2018	2182

Custom Modifications

AUTH	CBO	CCO	CFNTO	CFP	CFRMO	FB	FPEB	FTK	FTK_V	ID	MIP	RD	RECTKBK	RECTKL/R	RT	VTK
•	•	•	•	STD	•	•	•	•	•	•	•	•	•	•	•	•

Construction Upgrades

APW	PLE
•	•

Door Options

CG	MD	MFO
•	•	•

Non Soft-close Options

NSCFB	NSCH
•	•

VANITY BASE, SINGLE DOOR with DRAWER, 32" HIGH

12", 15", 18", 21"

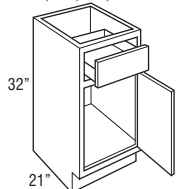

VB123221 L or R	504	531	587	627	679	705	717	772	788	860	930
VB153221 L or R	545	573	631	674	728	755	770	830	847	924	1001
VB183221 L or R	580	611	671	718	777	805	820	883	901	983	1062
VB213221 L or R	619	649	714	764	827	857	873	940	959	1048	1098

Custom Modifications

AUTH	CBO	CCO	CFNTO	CFP	CFRMO	FB	FPEB	FTK	FTK_V	ID	MIP	RD	RECTKBK	RECTKL/R	RT	VTK
•	•	•	•	•	•	•	•	•	• ¹	•	•	•	•	•	•	•

Construction Upgrades

APW	PLE
•	•

Door Options

CG	MD	MFO
•	•	•

Non Soft-close Options

NSCFB	NSCH
•	•

¹ Not available on 12" wide

VANITY BASE, SINGLE DOOR with DRAWER, 34 1/2" HIGH

12", 15", 18", 21"

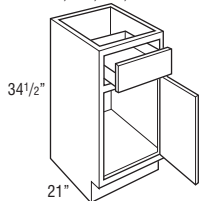

VB123421 L or R	538	566	623	665	720	746	759	820	837	910	984
VB153421 L or R	578	610	669	714	772	800	816	880	898	980	1060
VB183421 L or R	614	646	709	760	821	852	868	937	956	1044	1108
VB213421 L or R	656	689	759	809	875	908	926	996	1016	1110	1199

Custom Modifications

AUTH	CBO	CCO	CFNTO	CFP	CFRMO	FB	FPEB	FTK	FTK_V	ID	MIP	RD	RECTKBK	RECTKL/R	RT	VTK
•	•	•	•	•	•	•	•	•	• ¹	•	•	•	•	•	•	•

Construction Upgrades

APW	PLE
•	•

Door Options

CG	MD	MFO
•	•	•

Non Soft-close Options

NSCFB	NSCH
•	•

¹ Not available on 12" wide

VANITY BASE, DOUBLE DOOR with DRAWER, 32" HIGH

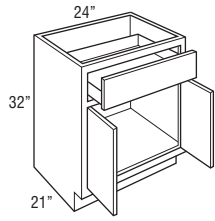

Price Point	1	2	3	4	5	6	7	8	9	10	11
VB243221	692	726	800	855	924	958	978	1052	1073	1170	1265

Custom Modifications

AUTH	CBO	CCO	CFNTO	CFP	CFRMO	FB	FPEB	FTK	FTK_V	ID	MIP	RD	RECTKBK	RECTKL/R	RT	VTK
•	•	•	•	•	•	•	•	•	•	•	•	•	•	•	•	•

Construction Upgrades

APW	PLE
•	•

Door Options

CG	MD	MFO
•	•	•

Non Soft-close Options

NSCFB	NSCH
•	•

VANITY BASE, DOUBLE DOOR with DRAWER, 34 1/2" HIGH

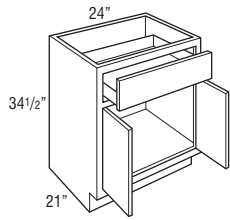

VB243421	733	769	848	903	978	1015	1034	1116	1138	1239	1343
-----------------	-----	-----	-----	-----	-----	------	------	------	------	------	------

Custom Modifications

AUTH	CBO	CCO	CFNTO	CFP	CFRMO	FB	FPEB	FTK	FTK_V	ID	MIP	RD	RECTKBK	RECTKL/R	RT	VTK
•	•	•	•	•	•	•	•	•	•	•	•	•	•	•	•	•

Construction Upgrades

APW	PLE
•	•

Door Options

CG	MD	MFO
•	•	•

Non Soft-close Options

NSCFB	NSCH
•	•

VANITY FOUR DRAWER BASE, 34 1/2" HIGH

12", 15", 18", 21", or 24"

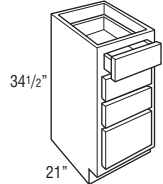

4VDB123421	740	760	807	834	882	905	910	952	972	1015	1067
4VDB153421	800	821	871	901	954	979	983	1030	1051	1098	1153
4VDB183421	862	885	939	970	1026	1053	1058	1108	1131	1183	1241
4VDB213421	920	945	1002	1035	1095	1124	1128	1183	1208	1263	1323
4VDB243421	988	1015	1078	1113	1178	1210	1213	1272	1297	1358	1425

• Exterior height of bottom drawer box is 6 3/8".

Custom Modifications

AUTH	CBO	CCO	CFNTO	CFP	CFRMO	FB	FPEB	FTK	FTK_V	ID	MIP	RD	RECTKBK	RECTKL/R	RT	VTK
•	•	•	•	•	•	•	•	•	• ¹	•	•	•	•	•	•	•

Construction Upgrades

APW	PLE
•	•

Door Options

CG	MD	MFO
•	•	•

Non Soft-close Options

NSCFB	NSCH
•	•

¹ Not available on 12" wide

VANITY DRAWER BASE, 32" HIGH

12", 15", 18", 21", 24", 27", or 30"

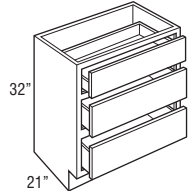

VDB123221	638	655	694	715	755	776	780	816	833	870	912
VDB153221	686	704	745	771	815	836	838	877	895	936	982
VDB183221	737	758	804	829	877	901	904	946	965	1010	1059
VDB213221	787	808	856	885	935	959	964	1008	1029	1075	1128
VDB243221	844	866	919	947	1002	1029	1032	1081	1104	1153	1209
VDB273221	970	996	1057	1089	1152	1183	1187	1244	1269	1325	1390
VDB303221	1116	1145	1215	1253	1324	1360	1365	1431	1460	1524	1599

Custom Modifications

AUTH	CBO	CCO	CFNTO	CFP	CFRMO	FB	FPEB	FTK	FTK_V	ID	MIP	RD	RECTKBK	RECTKL/R	RT	VTK
•	•	•	•	•	•	•	•	•	• ¹	•	•	•	•	•	•	•

Construction Upgrades

APW	PLE
•	•

Door Options

CG	MD	MFO
•	•	•

Non Soft-close Options

NSCFB	NSCH
•	•

¹ Not available on 12" wide

**VANITY DRAWER BASE,
34 1/2" HIGH**

12", 15", 18", 21", 24", 27", or 30"

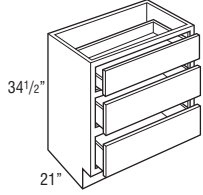

	Price Point	1	2	3	4	5	6	7	8	9	10	11
VDB123421		699	718	761	786	830	853	856	896	914	956	1003
VDB153421		750	769	817	844	891	914	918	961	982	1024	1075
VDB183421		807	829	877	905	958	985	987	1033	1054	1103	1156
VDB213421		861	883	938	969	1023	1050	1054	1104	1126	1176	1235
VDB243421		922	947	1004	1036	1096	1125	1131	1182	1207	1262	1323
VDB273421		1060	1089	1154	1192	1260	1294	1300	1359	1388	1451	1521
VDB303421		1219	1253	1328	1371	1450	1488	1495	1563	1596	1668	1750

Custom Modifications

AUTH	CBO	CCO	CFNTO	CFP	CFRMO	FB	FPEB	FTK	FTK_V	ID	MIP	RD	RECTKBK	RECTKL/R	RT	VTK
•	•	•		•	•	•	•	•	• ¹	•	•	•	•	•		•

Construction Upgrades

APW	PLE
•	•

Door Options

CG	MD	MFO

Non Soft-close Options

NSCFB	NSCH
•	

¹ Not available on 12" wide

**VANITY SINK DRAWER BASE,
32" HIGH**

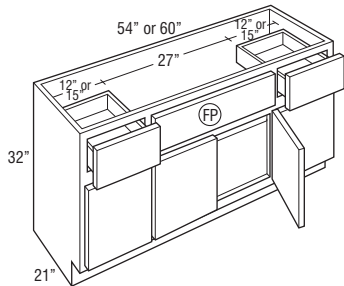
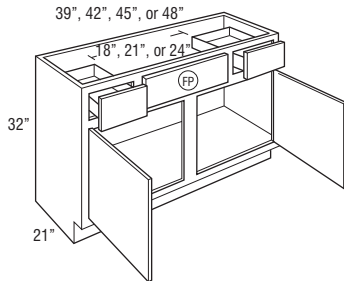
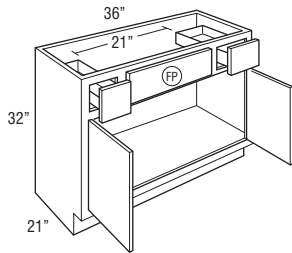

2VSD363221	870	913	1005	1075	1159	1200	1226	1323	1350	1472	1595
2VSD393221	936	984	1081	1155	1247	1293	1320	1423	1452	1582	1713
2VSD423221	1001	1053	1157	1236	1336	1385	1413	1523	1554	1692	1831
2VSD453221	1040	1094	1202	1285	1389	1441	1469	1583	1616	1760	1903
2VSD483221CS	1049	1104	1218	1305	1413	1465	1495	1614	1647	1798	1947
2VSD543221FP	1160	1219	1343	1435	1551	1608	1639	1769	1805	1964	2124
2VSD603221FP	1231	1294	1424	1520	1644	1705	1739	1871	1909	2083	2253

	Face Frame Opening Width			Available Sink Clearance Width	# of Sink Openings	# of Drawers
	Drawers	Side Doors	False Panel			
2VSD36...	6"	33" (butt doors)	15"	21"	1	2
2VSD39...	9"	16 1/2"	12"	18"	1	2
2VSD42...	9"	18"	15"	21"	1	2
2VSD45...	9"	19 1/2"	18"	24"	1	2
2VSD48...CS	12"	21"	15"	21"	1	2
2VSD54...	12"	12"	21"	27"	1	2
2VSD60...	15"	15"	21"	27"	1	2

Custom Modifications

AUTH	CBO	CCO	CFNTO	CFP	CFRMO	FB	FPEB	FTK	FTK_V	ID	MIP	RD	RECTKBK	RECTKL/R	RT	VTK
•	•	•		•	•	•	•	•	•	•	•	•	•	•	• ¹	•

Construction Upgrades

APW	PLE
•	•

Door Options

CG	MD	MFO

Non Soft-close Options

NSCFB	NSCH
•	

¹ Not available on 54" or 60" wide

(FP) = False Panel

VANITY SINK DRAWER BASE, 34 1/2" HIGH

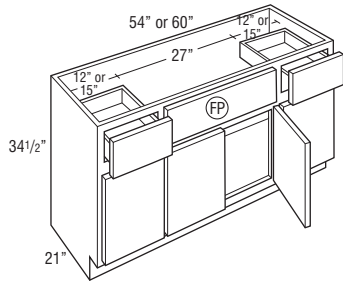
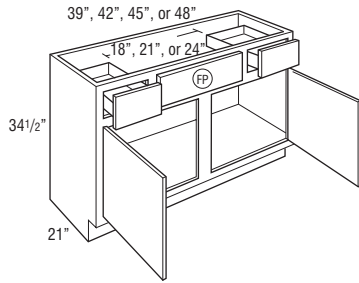
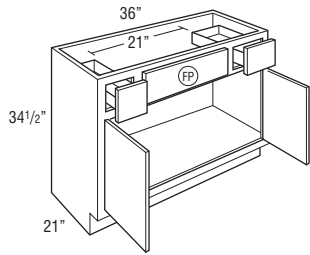

FP = False Panel

Price Point	1	2	3	4	5	6	7	8	9	10	11
2VSD363421	974	1025	1127	1207	1303	1350	1377	1486	1516	1648	1787

2VSD393421	1048	1101	1212	1295	1400	1452	1480	1596	1629	1772	1918
2VSD423421	1120	1178	1296	1384	1498	1554	1583	1706	1741	1897	2049
2VSD453421	1164	1225	1347	1439	1555	1613	1645	1772	1808	1971	2131
2VSD483421CS	1178	1240	1369	1463	1584	1644	1677	1810	1847	2014	2184

2VSD543421FP	1299	1367	1504	1605	1736	1801	1835	1980	2020	2200	2382
2VSD603421FP	1375	1448	1593	1701	1840	1909	1948	2097	2140	2333	2522

	Face Frame Opening Width			Available Sink Clearance Width	# of Sink Openings	# of Drawers
	Drawers	Side Doors	False Panel			
2VSD36...	6"	33" (butt doors)	15"	21"	1	2
2VSD39...	9"	16 1/2"	12"	18"	1	2
2VSD42...	9"	18"	15"	21"	1	2
2VSD45...	9"	19 1/2"	18"	24"	1	2
2VSD48...CS	12"	21"	15"	21"	1	2
2VSD54...	12"	12"	21"	27"	1	2
2VSD60...	15"	15"	21"	27"	1	2

Custom Modifications

AUTH	CBO	CCO	CFNT0	CFP	CFRMO	FB	FPEB	FTK	FTK_V	ID	MIP	RD	RECTKBK	RECTKL/R	RT	VTK
•	•	•	•	•	•	•	•	•	•	•	•	•	•	•	• ¹	•

Construction Upgrades

APW	PLE
•	•

Door Options

CG	MD	MFO
•	•	•

Non Soft-close Options

NSCFB	NSCH
•	•

¹ Not available on 54" or 60" wide

VANITY SINK WIDE DRAWER BASE with FALSE PANELS, 32" HIGH

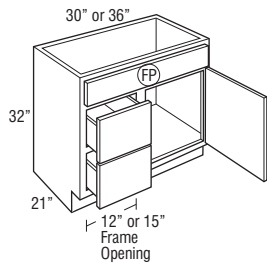

FP = False Panel

VSWD303221FP DL or DR	901	935	1003	1050	1120	1155	1166	1235	1260	1337	1418
VSWD363221FP DL or DR	992	1028	1104	1155	1231	1269	1283	1357	1385	1470	1561

• DL or DR indicates drawer location (DL shown).

	Face Frame Opening Width		Available Sink Clearance Width	# of Sink Openings	# of Drawers
	Drawers	Side Doors			
VSWD30..	12"	12"	27"	1	2
VSWD36..	15"	15"	33"	1	2

Custom Modifications

AUTH	CBO	CCO	CFNT0	CFP	CFRMO	FB	FPEB	FTK	FTK_V	ID	MIP	RD	RECTKBK	RECTKL/R	RT	VTK
•	•	•	•	STD	•	•	•	•	•	•	•	•	•	•	•	•

Construction Upgrades

APW	PLE
•	•

Door Options

CG	MD	MFO
•	•	•

Non Soft-close Options

NSCFB	NSCH
•	•

VANITY SINK WIDE DRAWER BASE with FALSE PANELS, 34 1/2" HIGH

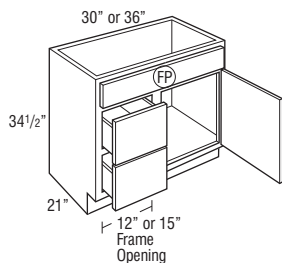

FP = False Panel

VSWD303421FP DL or DR	1010	1047	1124	1176	1255	1293	1306	1383	1411	1498	1591
VSWD363421FP DL or DR	1108	1147	1234	1292	1378	1421	1434	1517	1548	1644	1745

• DL or DR indicates drawer location (DL shown).

	Face Frame Opening Width		Available Sink Clearance Width	# of Sink Openings	# of Drawers
	Drawers	Side Doors			
VSWD30..	12"	12"	27"	1	2
VSWD36..	15"	15"	33"	1	2

Custom Modifications

AUTH	CBO	CCO	CFNT0	CFP	CFRMO	FB	FPEB	FTK	FTK_V	ID	MIP	RD	RECTKBK	RECTKL/R	RT	VTK
•	•	•	•	STD	•	•	•	•	•	•	•	•	•	•	•	•

Construction Upgrades

APW	PLE
•	•

Door Options

CG	MD	MFO
•	•	•

Non Soft-close Options

NSCFB	NSCH
•	•

**VANITY SINK DRAWER BASE
with FALSE PANELS, 32" HIGH**

24", 27", 30", or 33"

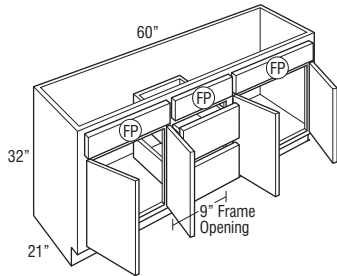
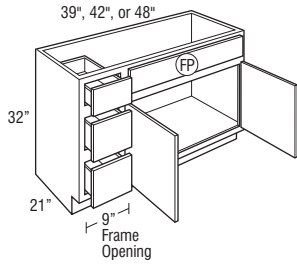
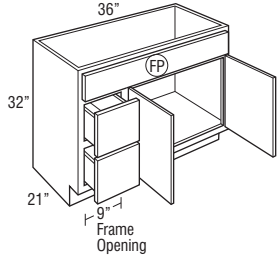
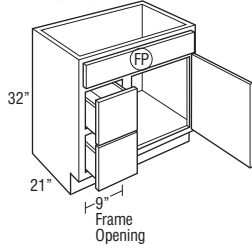

FP = False Panel

Price
Point

	1	2	3	4	5	6	7	8	9	10	11
VSD243221FP DL or DR	836	866	932	975	1040	1071	1082	1145	1169	1241	1318
VSD273221FP DL or DR	868	901	968	1013	1080	1114	1125	1190	1215	1290	1368
VSD303221FP DL or DR	901	935	1003	1050	1120	1155	1166	1235	1260	1337	1418
VSD333221FP DL or DR	947	982	1053	1103	1176	1212	1225	1296	1323	1404	1490

VSD363221FP DL or DR	992	1028	1104	1155	1231	1269	1283	1357	1385	1470	1561
----------------------	-----	------	------	------	------	------	------	------	------	------	------

VSD393221FP DL or DR	1045	1084	1164	1218	1299	1339	1352	1431	1460	1551	1645
----------------------	------	------	------	------	------	------	------	------	------	------	------

VSD423221FP DL or DR	1099	1140	1224	1281	1366	1407	1421	1504	1534	1630	1729
----------------------	------	------	------	------	------	------	------	------	------	------	------

VSD483221FP DL or DR	1148	1190	1280	1339	1427	1471	1486	1572	1604	1705	1809
----------------------	------	------	------	------	------	------	------	------	------	------	------

VSDS603221FP	1254	1300	1398	1463	1560	1608	1623	1719	1753	1863	1977
--------------	------	------	------	------	------	------	------	------	------	------	------

• DL or DR indicates drawer location (DL shown).

	Face Frame Opening Width		Available Sink Clearance Width	# of Sink Openings	# of Drawers
	Drawers	Doors			
VSD24...	9"	9"	21"	1	2
VSD27...	9"	12"	24"	1	2
VSD30...	9"	15"	27"	1	2
VSD33...	9"	18"	30"	1	2
VSD36...	9"	21"	33"	1	2
VSD39...	9"	24"	27"	1	3
VSD42...	9"	27"	30"	1	3
VSD48...	9"	33"	36"	1	3
VSDS60...	9"	21"	24"	2	2

Custom Modifications

AUTH	CBO	CCO	CFNT0	CFP	CFRMO	FB	FPEB	FTK	FTK_V	ID	MIP	RD	RECTKBK	RECTKL/R	RT	VTK
•	•	•		STD ¹	•	•	•	•	•	•	•	•	•	•	•	•

Construction Upgrades

APW	PLE
•	•

Door Options

CG	MD	MFO

Non Soft-close Options

NSCFB	NSCH
•	•

¹ Standard on 24", 27", 30", 33", 36" and 60" wide. Available on 39", 42", and 48" wide

VANITY SINK DRAWER BASE with FALSE PANEL, 34 1/2" HIGH

24", 27", 30", or 33"

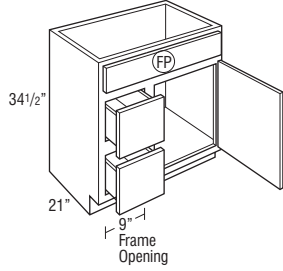

36"

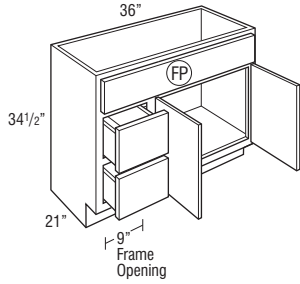

39", 42, or 48"

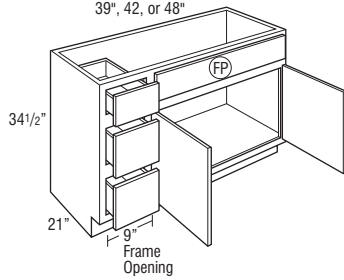

60"

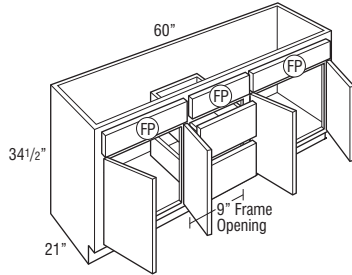

FP = False Panel

Price Point

	1	2	3	4	5	6	7	8	9	10	11
VSD243421FP DL or DR	935	967	1041	1089	1162	1198	1209	1280	1305	1386	1472
VSD273421FP DL or DR	973	1007	1082	1133	1209	1246	1258	1331	1358	1442	1532
VSD303421FP DL or DR	1010	1047	1124	1176	1255	1293	1306	1383	1411	1498	1591
VSD333421FP DL or DR	1059	1097	1179	1235	1316	1357	1370	1450	1480	1571	1668

VSD363421FP DL or DR	1108	1147	1234	1292	1378	1421	1434	1517	1548	1644	1745
----------------------	------	------	------	------	------	------	------	------	------	------	------

VSD393421FP DL or DR	1169	1210	1301	1361	1452	1497	1512	1600	1632	1733	1840
----------------------	------	------	------	------	------	------	------	------	------	------	------

VSD423421FP DL or DR	1228	1272	1368	1431	1526	1573	1590	1682	1716	1823	1932
----------------------	------	------	------	------	------	------	------	------	------	------	------

VSD483421FP DL or DR	1284	1331	1432	1498	1598	1647	1661	1760	1796	1907	2024
----------------------	------	------	------	------	------	------	------	------	------	------	------

VSDS603421FP	1403	1454	1565	1638	1747	1800	1817	1924	1963	2085	2212
--------------	------	------	------	------	------	------	------	------	------	------	------

• DL or DR indicates drawer location (DL shown).

	Face Frame Opening Width		Available Sink Clearance Width	# of Sink Openings	# of Drawers
	Drawers	Doors			
VSD24...	9"	9"	21"	1	2
VSD27...	9"	12"	24"	1	2
VSD30...	9"	15"	27"	1	2
VSD33...	9"	18"	30"	1	2
VSD36...	9"	21"	33"	1	2
VSD39...	9"	24"	27"	1	3
VSD42...	9"	27"	30"	1	3
VSD48...	9"	33"	36"	1	3
VSDS60..	9"	21"	24"	2	2

Custom Modifications

AUTH	CBO	CCO	CFNT0	CFP	CFRMO	FB	FPEB	FTK	FTK_V	ID	MIP	RD	RECTKBK	RECTKL/R	RT	VTK
•	•	•		STD ¹	•	•	•	•	•	•	•	•	•	•	•	•

Construction Upgrades

APW	PLE
•	•

Door Options

CG	MD	MFO

Non Soft-close Options

NSCFB	NSCH
•	•

¹ Standard on 24", 27", 30", 33", 36" and 60" wide. Available on 39", 42", and 48" wide

VANITY SINK THREE DRAWER BASE, 32" HIGH

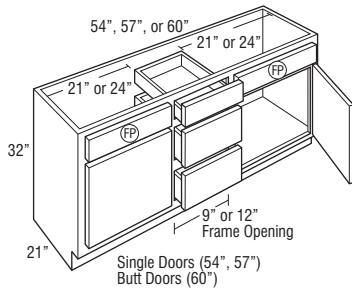

FP = False Panel

	1	2	3	4	5	6	7	8	9	10	11
VSDS543221	1556	1612	1735	1815	1935	1994	2013	2131	2174	2310	2451
VSDS573221	1556	1612	1735	1815	1935	1994	2013	2131	2174	2310	2451
VSDS603221	1556	1612	1735	1815	1935	1994	2013	2131	2174	2310	2451

	Face Frame Opening Width		Available Sink Clearance Width	# of Sink Openings	# of Drawers
	Drawers	Doors			
VSDS54...	9"	18"	21"	2	3
VSDS57...	12"	18"	21"	2	3
VSDS60...	9"	21"	24"	2	3

Custom Modifications

AUTH	CBO	CCO	CFNTO	CFP	CFRMO	FB	FPEB	FTK	FTK_V	ID	MIP	RD	RECTKBK	RECTKL/R	RT	VTK
•	•	•	•	•	•	•	•	•	•	•	•	•	•	•	•	•

Construction Upgrades

APW	PLE
•	•

Door Options

CG	MD	MFO
•	•	•

Non Soft-close Options

NSCFB	NSCH
•	•

VANITY SINK THREE DRAWER BASE, 34 1/2" HIGH

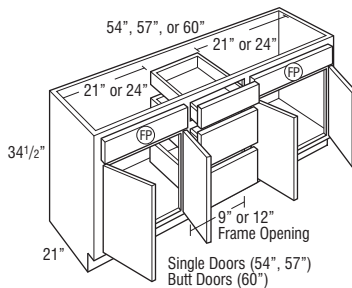

FP = False Panel

	1	2	3	4	5	6	7	8	9	10	11
VSDS543421	1743	1806	1944	2032	2167	2234	2256	2387	2435	2587	2746
VSDS573421	1743	1806	1944	2032	2167	2234	2256	2387	2435	2587	2746
VSDS603421	1743	1806	1944	2032	2167	2234	2256	2387	2435	2587	2746

	Face Frame Opening Width		Available Sink Clearance Width	# of Sink Openings	# of Drawers
	Drawers	Doors			
VSDS54...	9"	18"	21"	2	3
VSDS57...	12"	18"	21"	2	3
VSDS60...	9"	21"	24"	2	3

Custom Modifications

AUTH	CBO	CCO	CFNTO	CFP	CFRMO	FB	FPEB	FTK	FTK_V	ID	MIP	RD	RECTKBK	RECTKL/R	RT	VTK
•	•	•	•	•	•	•	•	•	•	•	•	•	•	•	•	•

Construction Upgrades

APW	PLE
•	•

Door Options

CG	MD	MFO
•	•	•

Non Soft-close Options

NSCFB	NSCH
•	•

VANITY SINK DRAWER BASE with SIX DRAWERS & FALSE PANEL, 32" HIGH

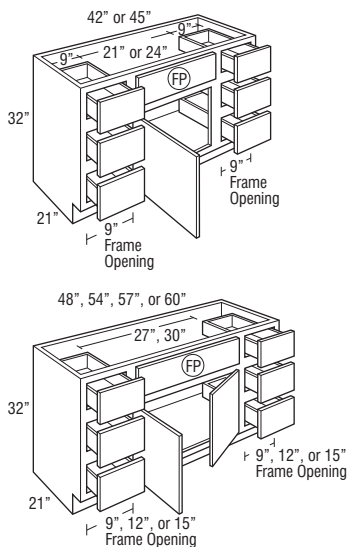

FP = False Panel

	1	2	3	4	5	6	7	8	9	10	11
6VSD423221FP L or R	1395	1445	1554	1626	1734	1788	1805	1910	1949	2071	2197
6VSD453221FP L or R	1395	1445	1554	1626	1734	1788	1805	1910	1949	2071	2197

	1	2	3	4	5	6	7	8	9	10	11
6VSD483221FP	1395	1445	1554	1626	1734	1788	1805	1910	1949	2071	2197
6VSD543221FP	1520	1575	1694	1772	1891	1949	1967	2083	2125	2257	2395
6VSD573221FP	1595	1655	1779	1861	1984	2046	2066	2187	2232	2370	2515
6VSD603221FP	1655	1714	1844	1928	2057	2121	2142	2266	2312	2456	2607

	Face Frame Opening Width		Available Sink Clearance Width	# of Sink Openings	# of Drawers
	Drawers	Doors			
6VSD42...	9"	15"	21"	1	6
6VSD45...	9"	18"	24"	1	6
6VSD48...	9"	21"	27"	1	6
6VSD54...	12"	21"	27"	1	6
6VSD57...	12"	24"	30"	1	6
6VSD60...	15"	21"	27"	1	6

Custom Modifications

AUTH	CBO	CCO	CFNTO	CFP	CFRMO	FB	FPEB	FTK	FTK_V	ID	MIP	RD	RECTKBK	RECTKL/R	RT	VTK
•	•	•	•	•	•	•	•	•	•	•	•	•	•	•	•	•

Construction Upgrades

APW	PLE
•	•

Door Options

CG	MD	MFO
•	•	•

Non Soft-close Options

NSCFB	NSCH
•	•

VANITY SINK DRAWER BASE with SIX DRAWERS & FALSE PANEL, 34 1/2" HIGH

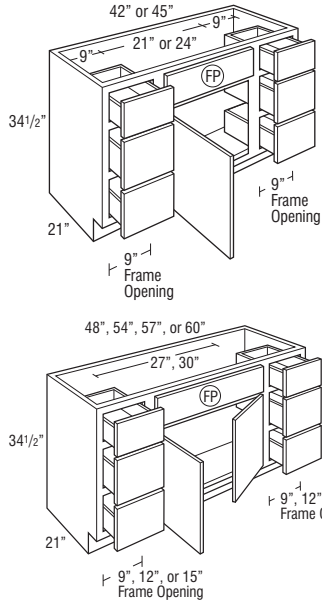

FP = False Panel

	Price Point	1	2	3	4	5	6	7	8	9	10	11
6VSD423421FP L or R		1561	1618	1740	1819	1941	2002	2021	2139	2182	2318	2459
6VSD453421FP L or R		1561	1618	1740	1819	1941	2002	2021	2139	2182	2318	2459

6VSD483421FP	1561	1618	1740	1819	1941	2002	2021	2139	2182	2318	2459
6VSD543421FP	1703	1764	1898	1985	2117	2183	2204	2332	2379	2528	2683
6VSD573421FP	1787	1853	1993	2084	2223	2292	2313	2449	2498	2655	2816
6VSD603421FP	1854	1920	2067	2162	2305	2377	2400	2540	2591	2752	2921

	Face Frame Opening Width		Available Sink Clearance Width	# of Sink Openings	# of Drawers
	Drawers	Doors			
6VSD42...	9"	15"	21"	1	6
6VSD45...	9"	18"	24"	1	6
6VSD48...	9"	21"	27"	1	6
6VSD54...	12"	21"	27"	1	6
6VSD57...	12"	24"	30"	1	6
6VSD60...	15"	21"	27"	1	6

Custom Modifications

AUTH	CBO	CCO	CFNT0	CFP	CFRMO	FB	FPEB	FTK	FTK_V	ID	MIP	RD	RECTKBK	RECTKL/R	RT	VTK
•	•	•		•	•	•	•	•	•	•	•	•	•	•	•	•

Construction Upgrades

APW	PLE
•	•

Door Options

CG	MD	MFO

Non Soft-close Options

NSCFB	NSCH
•	•

UNDER COUNTER DRAWER, 4 3/4" HIGH

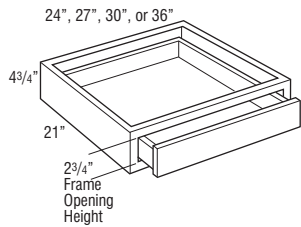

UCD2421	416	425	445	456	476	487	491	492	515	538	559
UCD2721	438	446	470	480	501	512	517	537	543	566	590
UCDS3021	455	465	488	500	521	532	538	558	564	588	613
UCDS3621	511	521	547	559	584	596	602	627	632	660	688

- Cabinet is 4 3/4" high. Drawer box within cabinet is 2" high (outside dimension).
- Not trimmable.
- Drawer front is 3/4" slab for all styles. Slab drawer fronts on certain laminate door styles will be painted hardwood. See Door Style section for exceptions.
- The frame to end panel offset is 3/4", which is designed to accommodate the vanity desk leg.
- Plywood end panels are unfinished.

Custom Modifications

AUTH	CBO	CCO	CFNT0	CFP	CFRMO	FB	FPEB	FTK	FTK_V	ID	MIP	RD	RECTKBK	RECTKL/R	RT	VTK
•	•				•					•		•				

Construction Upgrades

APW	PLE
•	STD

Door Options

CG	MD	MFO

Non Soft-close Options

NSCFB	NSCH

UNDER COUNTER DRAWER, TRIMMABLE, 4 3/4" HIGH, 21" DEEP

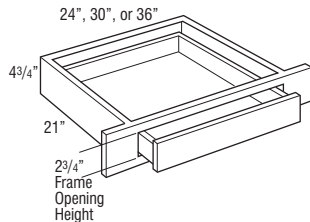

UCDT2421	416	425	445	456	476	487	491	492	515	538	559
UCDT3021	455	465	488	500	521	532	538	558	564	588	613
UCDT3621	511	521	547	559	584	596	602	627	632	660	688

- Cabinet is 4 3/4" high. Drawer box within cabinet is 2" high (outside dimension).
- Frame stile is trimmable 3" on each side, which leaves a face frame to end panel offset of 3/4" to accommodate the vanity desk leg.
- Drawer front is 3/4" slab for all styles. Slab drawer fronts on certain laminate door styles will be painted hardwood. See Door Style section for exceptions.
- Plywood end panels are unfinished.

Custom Modifications

AUTH	CBO	CCO	CFNT0	CFP	CFRMO	FB	FPEB	FTK	FTK_V	ID	MIP	RD	RECTKBK	RECTKL/R	RT	VTK
•	•				•					•		•				

Construction Upgrades

APW	PLE
•	STD

Door Options

CG	MD	MFO

Non Soft-close Options

NSCFB	NSCH

LINEN TALL CABINET with DRAWER, 84" HIGH

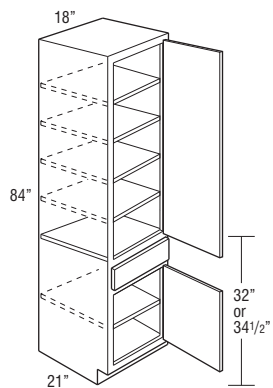

Price Point	1	2	3	4	5	6	7	8	9	10	11
LTD188421 L or R	1319	1376	1493	1579	1688	1743	1773	1892	1926	2079	2232
LTD188421BH L or R	1319	1376	1493	1579	1688	1743	1773	1892	1926	2079	2232

- LTD188421 designed to be used with 32" high vanities.
- LTD188421BH designed to be used with 34 1/2" high vanities.

Custom Modifications

AUTH	CBO	CCO	CFNTO	CFP	CFRMO	FB	FPEB	FTK	FTK_V	ID	MIP	RD	RECTKBK	RECTKL/R	RT	VTK
	•	•	•		•	•	•	•	•		•	•		•	•	•

Construction Upgrades

APW	PLE
•	•

Door Options

CG	MD	MFO
		•

Non Soft-close Options

NSCFB	NSCH
•	•

LINEN TALL CABINET with DRAWER and REMOVABLE HAMPER, 84" HIGH

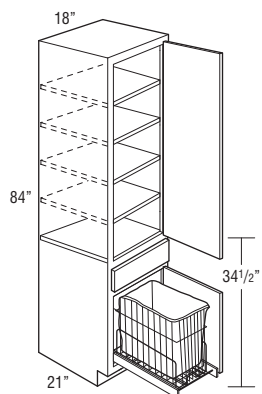

L188421BH L or R	1767	1824	1941	2027	2136	2191	2221	2340	2374	2527	2680
------------------	------	------	------	------	------	------	------	------	------	------	------

- L188421BH designed to be used with 34 1/2" high vanities and includes a full extension removable chrome pull-out hamper with removable cloth liner.
- Hamper size is 19 3/8" high x 14 3/4" wide x 18 deep.

Custom Modifications

AUTH	CBO	CCO	CFNTO	CFP	CFRMO	FB	FPEB	FTK	FTK_V	ID	MIP	RD	RECTKBK	RECTKL/R	RT	VTK
	•	•	•		•	•	•	•	•		•			•		•

Construction Upgrades

APW	PLE
•	•

Door Options

CG	MD	MFO
		•

Non Soft-close Options

NSCFB	NSCH
•	•

VANITY WALL CUBBY

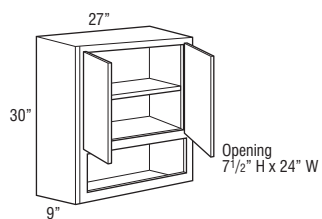

VWC2730	791	798	902	958	988	1003	1047	1103	1125	1187	1256
---------	-----	-----	-----	-----	-----	------	------	------	------	------	------

- Includes one adjustable shelf.

Custom Modifications

AUTH	CBO	CCO	CFNTO	CFP	CFRMO	FB	FPEB	FTK	FTK_V	ID	MIP	RD	RECTKBK	RECTKL/R	RT	VTK
	•	•	•		•	•					STD					

Construction Upgrades

APW	PLE

Door Options

CG	MD	MFO
		•

Non Soft-close Options

NSCFB	NSCH
	•

VANITY WALL, 30" HIGH, 6" DEEP

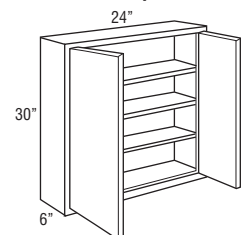

W24306	538	566	628	666	722	750	762	823	839	914	988
--------	-----	-----	-----	-----	-----	-----	-----	-----	-----	-----	-----

- If a different depth is desired, select a kitchen cabinet with ID or RD modifications available.

Custom Modifications

AUTH	CBO	CCO	CFNTO	CFP	CFRMO	FB	FPEB	FTK	FTK_V	ID	MIP	RD	RECTKBK	RECTKL/R	RT	VTK
	•	•	•		•	•	•				•					

Construction Upgrades

APW	PLE
•	•

Door Options

CG	MD	MFO
•	•	•

Non Soft-close Options

NSCFB	NSCH
	•

VANITY WALL MIRROR CABINET, 30" HIGH, 4 9/16" DEEP

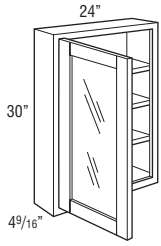

Price Point	1	2	3	4	5	6	7	8	9	10	11
VWM2430 L or R	612	668	760	784	801	809	834	858	905	972	1002

- Available on most door styles. See Door Style section for exceptions.
- Standard with CG doors and installed mirror glass.
- Unit intended to be surface mounted. Features standard 1/4" face frame reveal on ends.
- Adjustable shelves.

Custom Modifications

AUTH	CBO	CCO	CFNTO	CFP	CFRMO	FB	FPEB	FTK	FTK_V	ID	MIP	RD	RECTKBK	RECTKL/R	RT	VTK
	•	•	•		•	•	•				•					

Construction Upgrades		Door Options			Non Soft-close Options	
APW	PLE	CG	MD	MFO	NSCFB	NSCH
•	•	STD				•

VANITY MIRROR

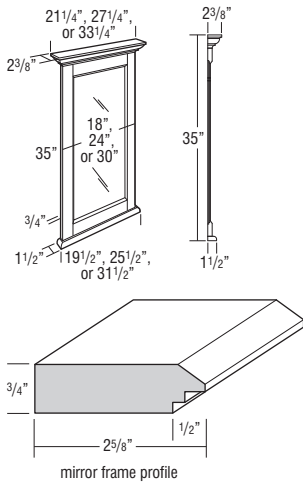

VM2135	N/A	851	851	851	851	851	851	851	851	851	851
VM2735	N/A	922	922	922	922	922	922	922	922	922	922
VM3335	N/A	1005	1005	1005	1005	1005	1005	1005	1005	1005	1005

- Moulding included on vanity mirrors is not a standard moulding. SWLCRM8 is similar.
- Mirror glass is beveled.
- Includes two installed metal hanging hooks on back.

Model	Overall Dimensions Width	Overall Dimensions Height	Mirror - Visible Dimensions Width	Mirror - Visible Dimensions Height
VM2135	21 1/4"	35"	12 15/16"	26 15/16"
VM2735	27 1/4"	35"	18 15/16"	26 15/16"
VM3335	33 1/4"	35"	24 15/16"	26 15/16"

MODIFICATIONS

No modifications available for these products.

Species Availability

Cherry	Maple	Oak	Laminate	Painted
•	•		Painted	•

SINGLE DOOR MEDICINE CABINET

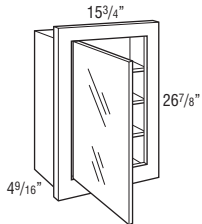

MC16	840	840	840	840	840	840	840	840	840	840	840
-------------	-----	-----	-----	-----	-----	-----	-----	-----	-----	-----	-----

- Unit can be surface mounted or recessed.
- Door of cabinet is glass mirror, 12 5/8" wide x 23 1/2" high.
- Matching cabinet doors not available.
- Cabinet has wood frame.
- Finished exterior.
- Natural Maple laminate interior.

Model	Cabinet Dimensions			Cut-out Dimensions		
	Width	Height	Depth	Width	Height	Depth
MC16	15 3/4"	26 7/8"	4 9/16"	14 7/16"	25 5/8"	4"

Custom Modifications

AUTH	CBO	CCO	CFNTO	CFP	CFRMO	FB	FPEB	FTK	FTK_V	ID	MIP	RD	RECTKBK	RECTKL/R	RT	VTK
	•	•				•	STD				•					

Construction Upgrades		Door Options			Non Soft-close Options	
APW	PLE	CG	MD	MFO	NSCFB	NSCH
STD						

TRI-VIEW MEDICINE CABINET

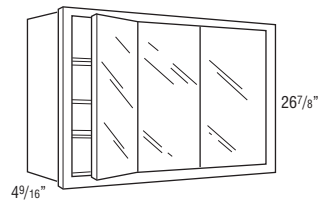

TV30	1140	1140	1140	1140	1140	1140	1140	1140	1140	1140	1140
TV36	1238	1238	1238	1238	1238	1238	1238	1238	1238	1238	1238

- Cabinet has wood frame.
- Door of cabinet is glass mirror.
- Unit can be surface mounted or recessed.
- Finished exterior.
- Natural Maple laminate interior.

Model	Cabinet Dimensions			Cut-out Dimensions		
	Width	Height	Depth	Width	Height	Depth
TV30	30"	26 7/8"	4 9/16"	28 11/16"	25 5/8"	4"
TV36	36"	26 7/8"	4 9/16"	34 11/16"	25 5/8"	4"

Custom Modifications

AUTH	CBO	CCO	CFNTO	CFP	CFRMO	FB	FPEB	FTK	FTK_V	ID	MIP	RD	RECTKBK	RECTKL/R	RT	VTK
	•	•				•	STD				•					

Construction Upgrades		Door Options			Non Soft-close Options	
APW	PLE	CG	MD	MFO	NSCFB	NSCH
STD						

TABLE OF CONTENTS – FILLERS & PANELS

Fillers123
 Box Column Fillers125
 End Panel Skins126
 Back Panels127
 End Panels128
 End Panel with Filler Attached129
 Decorative Door Panel Kits131

When designing with full overlay door styles, apply overlay fillers onto fillers.

All 1/4" thick panel material cannot be used in conjunction with cabinets with FPEB or AUTHL/AUTHR/AUTHB modifications.

SPECIES AVAILABILITY

Species Availability charts list the availability of each product code by species and any substitutions that are made. Additional exceptions within a section are noted below the species availability chart.

For panels with doors and/or fillers attached, species availability is shown for the panel and filler only.

For Species Availability, look for this chart throughout.

Species Availability

Cherry	Maple	Oak	Laminate	Painted
•	•	•	Painted	•

DESCRIPTION	MODEL	PRICE
FILLERS		

3" WIDE FILLERS

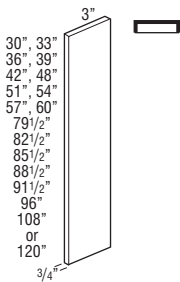

F3



F330	58
F333	64
F336	70
F339	73
F342	78
F348	78
F351	84
F354	90
F357	96
F360	102
TF384	126
TF387	140
TF390	155
TF393	180
TF396	185
TF396FH	232
TF3108FH† ♦	302
TF3120FH† ♦	311



- 3/4" thick.
 - Finished on front and all edges (backs are not finished).
- †5 day Express Response not available.

Species Availability

Cherry	Maple	Oak	Laminate	Painted
•	•	•	Painted	•

♦ Not available in Cherry and Oak.

DESCRIPTION

MODEL

PRICE

3" WIDE CORNER FILLER



CF330

106

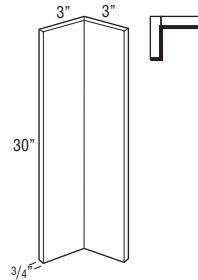

CF3

- 3/4" thick.
- Finished on front and all edges (backs are not finished).

Species Availability

Cherry	Maple	Oak	Laminate	Painted
•	•	•	Painted	•

6" WIDE FILLERS



F630

92

F633

102

F636

114

F639

125

F642

133

TF684

219

TF687

246

TF690

270

TF693

306

TF696

316

TF696FH

397

TF6108FH† ♦

516

TF6120FH† ♦

535



- 3/4" thick.
 - Finished on front and all edges (backs are not finished).
- †5 day Express Response not available.

Species Availability

Cherry	Maple	Oak	Laminate	Painted
•	•	•	Painted	•

♦ Not available in Cherry and Oak.

DESCRIPTION MODEL PRICE

OVERLAY FILLER, 2 1/2" WIDE



OL312	55
OL315	56
OL318	58
OL321	61
OL324	62
OL327	63
OL330	74
OL333	81
OL336	87
OL339	93
OL342	93
OL384	155
OL387	164
OL390	172
OL393	188
OL396	192

Model	Partial Overlay Height	Full Overlay Height
OL312		11 1/2"
OL315		14 1/2"
OL318		17 1/2"
OL321		20 1/2"
OL324		23 1/2"
OL327		26 1/2"
OL330	28"	29 1/2"
OL333	31"	32 1/2"
OL336	34"	35 1/2"
OL339	37"	38 1/2"
OL342	40"	41 1/2"
OL384		79"
OL387		82"
OL390		85"
OL393		88"
OL396		91"

- 2 1/2" wide overlay fillers can be applied to Wall Message Centers to create custom finished look.
- Finished on front and all edges (backs are not finished).
- All overlays will match the door style outside profile and thickness unless a noted exception is listed in the Door Style section. Certain door style overlays will be painted hardwood. See Door Style section for exceptions.
- See OL__MFO for use with Modified Full Overlay modification.

Species Availability

Cherry	Maple	Oak	Laminate	Painted
•	•	•	•	•

DESCRIPTION MODEL PRICE

OVERLAY FILLER for MODIFIED FULL OVERLAY, 2 1/2" WIDE

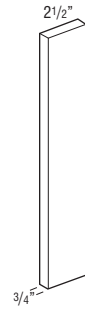

OL312MFO	55
OL315MFO	56
OL318MFO	58
OL321MFO	61
OL324MFO	62
OL327MFO	63
OL330MFO	74
OL333MFO	81
OL336MFO	87
OL339MFO	93
OL342MFO	93
OL384MFO	155
OL387MFO	164
OL390MFO	172
OL393MFO	188
OL396MFO	192

Model	Modified Full Overlay Height
OL312MFO	10 3/4"
OL315MFO	13 3/4"
OL318MFO	16 3/4"
OL321MFO	19 3/4"
OL324MFO	22 3/4"
OL327MFO	25 3/4"
OL330MFO	28 3/4"
OL333MFO	31 3/4"
OL336MFO	34 3/4"
OL339MFO	37 3/4"
OL342MFO	40 3/4"
OL384MFO	78 1/4"
OL387MFO	81 1/4"
OL390MFO	84 1/4"
OL393MFO	87 1/4"
OL396MFO	90 1/4"

- Available in full overlay door styles. Height will align with wall and tall doors specified with Modified Full Overlay modification. See page 4 for MFO details.
- 2 1/2" wide overlay fillers can be applied to Wall Message Centers to create custom finished look.
- Finished on front and all edges (backs are not finished).
- All overlays will match the door style outside profile and thickness unless a noted exception is listed in the Door Style section. Certain door style overlays will be painted hardwood. See Door Style section for exceptions.

Door Options

MFO
STD

Species Availability

Cherry	Maple	Oak	Laminate	Painted
•	•	•	•	•

DESCRIPTION MODEL PRICE

OVERLAY FILLER, 5 1/2" WIDE



OL630	105
OL633	123
OL636	139
OL639	152
OL642	155
OL684	257
OL687	277
OL690	301
OL693	316
OL696	316

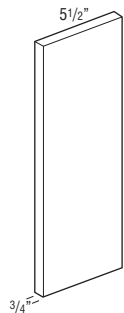

Model	Partial Overlay Height	Full Overlay Height
OL630	28"	29 1/2"
OL633	31"	32 1/2"
OL636	34"	35 1/2"
OL639	37"	38 1/2"
OL642	40"	41 1/2"
OL684		79"
OL687		82"
OL690		85"
OL693		88"
OL696		91"

- Finished on front and all edges (backs are not finished).
- All overlays will match the door style outside profile and thickness unless a noted exception is listed in the Door Style section. Certain door style overlays will be painted hardwood. See Door Style section for exceptions.
- See OL__MFO for use with Modified Full Overlay modification.

Species Availability

Cherry	Maple	Oak	Laminate	Painted
•	•	•	•	•

OVERLAY FILLER for MODIFIED FULL OVERLAY, 5 1/2" WIDE



OL630MFO	105
OL633MFO	123
OL636MFO	139
OL639MFO	152
OL642MFO	155
OL684MFO	257
OL687MFO	277
OL690MFO	301
OL693MFO	316
OL696MFO	316

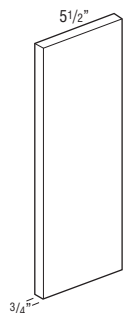

- Available in full overlay door styles. Height will align with wall and tall doors specified with Modified Full Overlay modification. See page 4 for MFO details.
- Finished on front and all edges (backs are not finished).
- All overlays will match the door style outside profile and thickness unless a noted exception is listed in the Door Style section. Certain door style overlays will be painted hardwood. See Door Style section for exceptions.

Door Options

MFO
STD

Species Availability

Cherry	Maple	Oak	Laminate	Painted
•	•	•	•	•

Model	Modified Full Overlay Height
OL630MFO	28 3/4"
OL633MFO	31 3/4"
OL636MFO	34 3/4"
OL639MFO	37 3/4"
OL642MFO	40 3/4"
OL684MFO	78 1/4"
OL687MFO	81 1/4"
OL690MFO	84 1/4"
OL693MFO	87 1/4"
OL696MFO	90 1/4"

DESCRIPTION MODEL PRICE

ANGLED 3" WIDE FILLERS



BLVDF30	198
3" x 30"	
BLVDF34.5	291
3" x 34 1/2"	

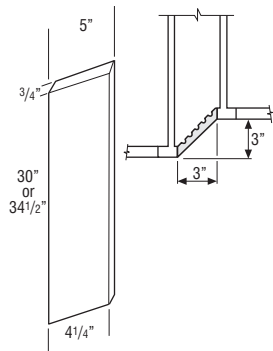

Species Availability

Cherry	Maple	Oak	Laminate	Painted
•	•	•	Painted	•

BOX COLUMN FILLERS, WALL, 3" WIDE, 15" DEEP

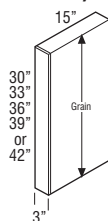

W330BCFP	492
W333BCFP	512
W336BCFP	531
W339BCFP	571
W342BCFP	571

- Reversible, may be used on either left or right end.
- Front and both sides finished.
- Enclosed top and bottom (not finished).
- 1/2" plywood construction.
- Flush finished veneer end panel exterior.
- Not intended for use horizontally as shelving. Use Floating Shelves on page 144.

Custom Modifications

ID	RD
•	•

Species Availability

Cherry	Maple	Oak	Laminate	Painted
•	•	•	Painted	•

BOX COLUMN FILLERS, BASE, 3" WIDE, 27" DEEP

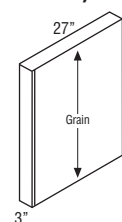

B334.527BCFP	898
--------------	-----

- Reversible, may be used on either left or right end.
- Front and both sides finished.
- Enclosed top and bottom (not finished).
- 1/2" plywood construction.
- Flush finished veneer end panel exterior.
- Not intended for use horizontally as shelving. Use Floating Shelves on page 144.

Custom Modifications

ID	RD
	•

Species Availability

Cherry	Maple	Oak	Laminate	Painted
•	•	•	Painted	•

DESCRIPTION MODEL PRICE

**BOX COLUMN FILLERS, TALL,
3" WIDE, 15" or 27" DEEP**

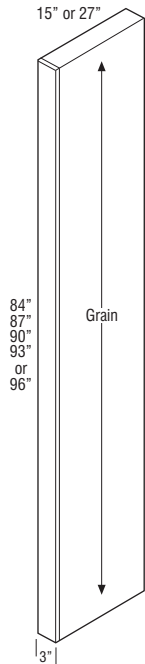

T38415BCFP (15" Deep)	1154
T38715BCFP (15" Deep)	1162
T39015BCFP (15" Deep)	1171
T39315BCFP (15" Deep)	1193
T39615BCFP (15" Deep)	1193
T38427BCFP (27" Deep)	1771
T38727BCFP (27" Deep)	1784
T39027BCFP (27" Deep)	1799
T39327BCFP (27" Deep)	1817
T39627BCFP (27" Deep)	1817

- Reversible, may be used on either left or right end.
- Front and both sides finished.
- Enclosed top and bottom (not finished).
- 1/2" plywood construction.
- Flush finished veneer end panel exterior.
- Not intended for use horizontally as shelving. Use Floating Shelves on page 144.

Custom Modifications

ID	RD
•	•

¹ Not available on 27" deep.

Species Availability

Cherry	Maple	Oak	Laminate	Painted
•	•	•	Painted	•

DESCRIPTION MODEL PRICE
PANELS & SKINS

END PANEL SKINS, WALL

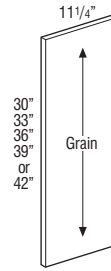

1/4" Finished	
WEPS30WD	92
WEPS33WD	102
WEPS36WD	114
WEPS39WD	125
WEPS42WD	133
1/4" Laminate	
WEPS30LAM14 ♦	50
WEPS33LAM14 ♦	60
WEPS36LAM14 ♦	62
WEPS39LAM14 ♦	70
WEPS42LAM14 ♦	76

- WEPS__WD in Stains: 1/4" thick veneered furniture board.
- WEPS__WD in Paints: 1/4" thick veneered or solid furniture board.
- WEPS__LAM14: 1/4" thick laminated furniture board.

Custom Modifications

ID	RD
•	•

Species Availability

Cherry	Maple	Oak	Laminate	Painted
•	•	•	Painted	•

♦ Only available in White laminate.

END PANEL SKINS, BASE

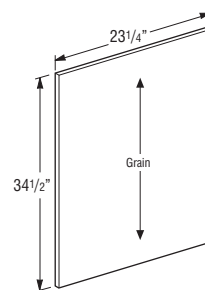

1/4" Finished	
BEPS34.5WD	149
1/4" Laminate	
BEPS34.5LAM14 ♦	92

- BEPS34.5WD in Stains: 1/4" thick veneered furniture board.
- BEPS34.5WD in Paints: 1/4" thick veneered or solid furniture board.
- BEPS34.5LAM14: 1/4" thick laminated furniture board.

Custom Modifications

ID	RD
•	•

Species Availability

Cherry	Maple	Oak	Laminate	Painted
•	•	•	Painted	•

♦ Only available in White laminate.

DESCRIPTION

MODEL

PRICE

END PANEL SKINS, TALL

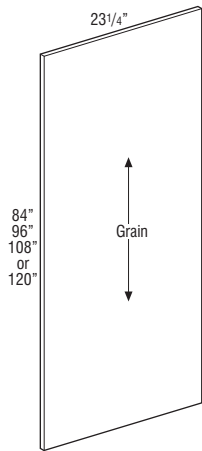
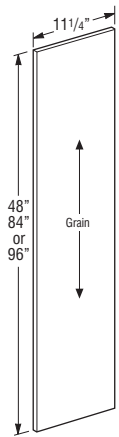

1/4" Finished	
TEPS1248WD	191
TEPS1284WD†	276
TEPS1296WD†	276
1/4" Laminate	
TEPS1248LAM14 ♦	118
TEPS1284LAM14† ♦	153
TEPS1296LAM14† ♦	153

1/4" Finished	
TEPS84WD†	325
TEPS96WD†	437
TEPS108WD†	552
TEPS120WD†	608
1/4" Laminate	
TEPS84LAM14† ♦	229
TEPS96LAM14† ♦	285

- TEPS__WD in Stains: 1/4" thick veneered furniture board.
 - TEPS__WD in Paints: 1/4" thick veneered or solid furniture board.
 - TEPS__LAM14: 1/4" thick laminated furniture board.
 - TEPS108WD and TEPS120WD only available in maple, painted hardwood, and laminate.
- †5 day Express Response not available on items greater than 48".

Custom Modifications

ID	RD
•	•

Species Availability

Cherry	Maple	Oak	Laminate	Painted
•	•	•	Painted	•

♦ Only available in White laminate.

FINISHED BACK SKINS

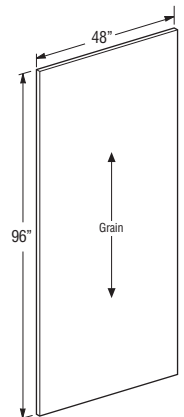
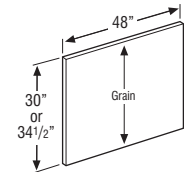

1/4" Finished	
BP4830WD	226
BP4834.5WD	263
1/4" Laminate	
BP4830LAM14 ♦	110
BP4834.5LAM14 ♦	121

1/4" Finished	
BP4896WD†	550
1/4" Laminate	
BP4896LAM14† ♦	270

- BP__WD in Stains is 1/4" thick veneered furniture board.
 - BP__WD in Paints is 1/4" thick veneered or solid furniture board.
 - BP__LAM14 is 1/4" thick laminated furniture board.
- †5 day Express Response not available on items greater than 48".

Custom Modifications

ID	RD
•	•

Species Availability

Cherry	Maple	Oak	Laminate	Painted
•	•	•	Painted	•

♦ Only available in White laminate.

DESCRIPTION

MODEL

PRICE

INTERIOR SKIN

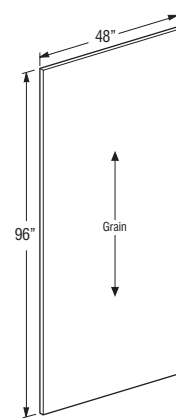

1/4" Natural Maple Laminate	
BP4896LAM	247

- 1/4" thick furniture board with Natural Maple laminate to match standard cabinet interior.

Custom Modifications

ID	RD
•	•

Species Availability

Cherry	Maple	Oak	Laminate	Painted
•	•	•	Painted	•

CROSS GRAIN VENEER BACK SKIN 1/4" PANELS

BP9634.5CRSGR	715
BP9648CRSGR	715

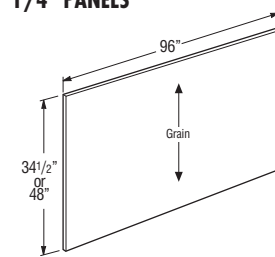

- Stains: 1/4" thick veneered furniture board.
- Paints: 1/4" thick veneered or solid furniture board.
- When ordered in Paint finishes, panels will use vertical grain as grain will not be visible.

Custom Modifications

ID	RD
•	•

Species Availability

Cherry	Maple	Oak	Laminate	Painted
•	•	•	Painted	•

WOOD V-GROOVED BEADED SKIN 1/4" PANELS



BP4834.5VG	444
BP4896VG†	1019

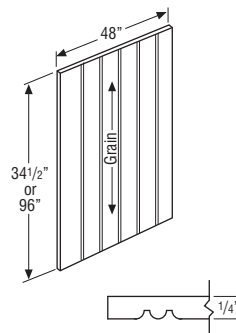

- BP48__VG is a 1/4" thick veneered panel with an MDF core.
 - V-groove on 3" centers.
- †5 day Express Response not available on items greater than 48".

Custom Modifications

ID	RD
•	•

Species Availability

Cherry	Maple	Oak	Laminate	Painted
•	•	•	Painted	•

DESCRIPTION **MODEL** **PRICE**

END PANELS, WALL  3/4" Finished

WEP1230WD 151

3/4" Laminate

WEP1230LAM ♦ 102

- WEP1230WD in Stains: 3/4" thick veneered furniture board.
- WEP1230WD in Paints: 3/4" thick veneered or solid furniture board.
- WEP1230LAM is 3/4" thick laminated furniture board.
- Panels are finished on two sides and front edge.

Custom Modifications

APW	ID	RD
• ¹	•	•

¹ Only available on WEP1230WD.

Species Availability

Cherry	Maple	Oak	Laminate	Painted
•	•	•	Painted	•

♦ Only available in White laminate.

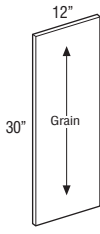

END PANELS, BASE

3/4" Finished

BEPWD 244

3/4" Laminate

BEPLAM ♦ 165

- BEPWD in Stains: 3/4" thick veneered furniture board.
- BEPWD in Paints: 3/4" thick veneered or solid furniture board.
- BEPLAM is 3/4" thick laminated furniture board.
- Panels are finished on two sides and front edge.

Custom Modifications

APW	ID	RD
• ¹	•	•

¹ Only available on BEPWD.

Species Availability

Cherry	Maple	Oak	Laminate	Painted
•	•	•	Painted	•

♦ Only available in White laminate.

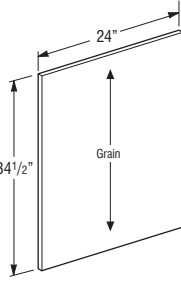

END PANELS, LAZY SUSAN  1/2" Finished

BLSBEPWD 259

1/2" Laminate

BLSBEPLAM 165

- BLSBEPWD: 1/2" thick veneered plywood.
- BLSBEPLAM: 1/2" thick laminated furniture board.
- All panels are finished one side and have Natural Maple laminate on the other side.

Custom Modifications

ID	RD
•	•

Species Availability

Cherry	Maple	Oak	Laminate	Painted
•	•	•	Painted	•

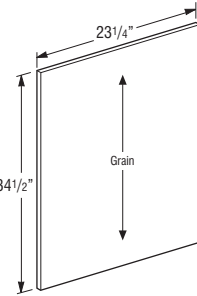

DESCRIPTION **MODEL** **PRICE**

END PANELS, TALL  3/4" Finished

TEP1248WD 272

TEP1296WD[†] 379

3/4" Laminate

TEP1248LAM ♦ 149

TEP1296LAM ♦ 214

3/4" Finished

TEP2484WD[†] 531

TEP2487WD[†] 586

TEP2490WD[†] 641

TEP2493WD[†] 744

TEP2496WD[†] 744

3/4" Laminate

TEP2484LAM ♦ 291

TEP2487LAM ♦ 323

TEP2490LAM ♦ 357

TEP2493LAM ♦ 417

TEP2496LAM ♦ 417

3/4" Finished

TEP3084WD[†] 690

TEP3096WD[†] 967

3/4" Laminate

TEP3084LAM ♦ 378

TEP3096LAM ♦ 543

- TEP__WD in Stains: 3/4" thick veneered furniture board.
- TEP__WD in Paints: 3/4" thick veneered or solid furniture board.
- TEP__LAM is 3/4" thick laminated furniture board.
- Panels are finished on two sides and front edge.

[†] 5 day Express Response not available on items greater than 48".

Custom Modifications

APW	ID	RD
• ¹	•	•

¹ Only available on WD SKUs.

Species Availability

Cherry	Maple	Oak	Laminate	Painted
•	•	•	Painted	•

♦ Only available in White laminate.

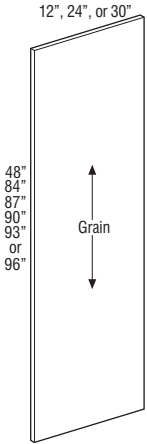

DESCRIPTION

MODEL

PRICE

END PANELS, TALL

3/4" Finished

TEP12108WD 587

TEP24108WD 1153

NEW **TEP12120WD** 646

NEW **TEP24120WD** 1269

- TEP__WD is 3/4" thick veneered plywood.
- Panels are finished on two sides and front edge.

Custom Modifications

APW	ID	MIP	RD
	•	STD	•

Species Availability

Cherry	Maple	Oak	Laminate	Painted
	•		Painted	•

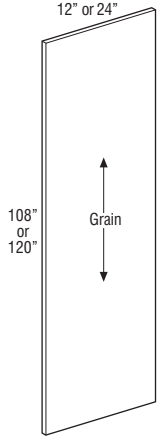

DESCRIPTION

MODEL

PRICE

BASE and TALL PANELS with FILLER ATTACHED



1/2" Finished

BEPF1.5WD 306

BEPF3WD 334

1/2" Laminate

BEPF1.5LAM 238

BEPF3LAM 267

1/2" Finished

TEP2484F1.5WD† 625

TEP2484F3WD† 695

TEP2487F1.5WD† 690

TEP2487F3WD† 765

TEP2490F1.5WD† 750

TEP2490F3WD† 835

TEP2493F1.5WD† 876

TEP2493F3WD† 974

TEP2496F1.5WD† 876

TEP2496F3WD† 974

1/2" Laminate

TEP2484F1.5LAM† 405

TEP2484F3LAM† 448

TEP2487F1.5LAM† 448

TEP2487F3LAM† 498

TEP2490F1.5LAM† 490

TEP2490F3LAM† 546

TEP2493F1.5LAM† 577

TEP2493F3LAM† 644

TEP2496F1.5LAM† 577

TEP2496F3LAM† 644

- BEPF_WD and TEP__F_WD in Stains: 1/2" thick veneered plywood.
 - BEPF_WD and TEP__F_WD in Paints: 1/2" thick veneered or solid plywood.
 - BEPF_LAM and TEP__F_LAM is 1/2" thick laminated furniture board.
 - All panels have Natural Maple laminate interior
- †5 day Express Response not available on items greater than 48".

Custom Modifications

APW	ID	MIP	RD
STD ¹	•	• ²	•

¹ Standard on WD SKUs. Not available on LAM SKUs.
² Only available on WD SKUs.

Species Availability

Cherry	Maple	Oak	Laminate	Painted
•	•	•	Painted	•

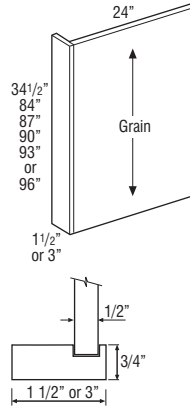

DESCRIPTION MODEL PRICE

TALL PANELS with FILLER ATTACHED

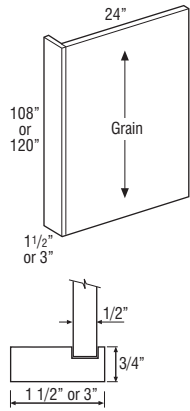

TEP24108F1.5WD	1314
TEP24108F3WD	1461
NEW TEP24120F1.5WD	1446
NEW TEP24120F3WD	1608

- TEP__F_WD is 1/2" thick veneered plywood.
- All panels have Natural Maple laminate interior.

Custom Modifications

APW	ID	MIP	RD
STD	•		•

Species Availability

Cherry	Maple	Oak	Laminate	Painted
	•		Painted	•

BASE and TALL PANELS with FILLER ATTACHED and FURNITURE ENDS

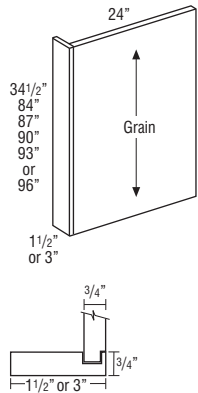

5 DAY BEPF1.5FPE	351
BEPF3FPE	384

TEP2484F1.5FPE†	721
TEP2484F3FPE†	799
TEP2487F1.5FPE†	832
TEP2487F3FPE†	880
TEP2490F1.5FPE†	864
TEP2490F3FPE†	961
TEP2493F1.5FPE†	1010
TEP2493F3FPE†	1118
TEP2496F1.5FPE†	1010
TEP2496F3FPE†	1118

- 3/4" thick veneered plywood.
 - All panels have Natural Maple laminate interior.
- †5 day Express Response not available on items greater than 48".

Custom Modifications

APW	FPFB	ID	MIP	RD
STD		•	•	•

Species Availability

Cherry	Maple	Oak	Laminate	Painted
•	•	•	Painted	•

TALL PANELS with FILLER ATTACHED and FURNITURE ENDS

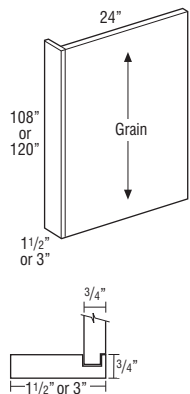

TEP24108F1.5FPE	1484
TEP24108F3FPE	1651
NEW TEP24120F1.5FPE	1633
NEW TEP24120F3FPE	1817

- TEP__F_FPE is 3/4" thick veneered plywood.

Custom Modifications

APW	FPFB	ID	MIP	RD
STD		•	STD	•

Species Availability

Cherry	Maple	Oak	Laminate	Painted
	•		Painted	•

DESCRIPTION MODEL PRICE

VANITY DESK LEGS

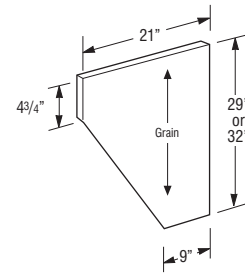

VDL2129WD	236
VDL2132WD	236

- All panels are finished 2 sides and front edge.
- VDL__WD in Stains: 3/4" thick veneered furniture board.
- VDL__WD in Paints: 3/4" thick veneered or solid furniture board.

Custom Modifications

ID	RD

Species Availability

Cherry	Maple	Oak	Laminate	Painted
•	•	•	Painted	•

DECORATIVE DOOR PANEL KIT, WALL END

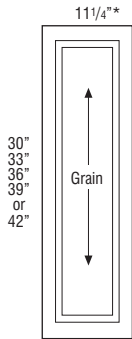

	Price Point	1	2	3	4	5	6	7	8	9	10	11
WED1230		295	310	343	364	395	410	417	448	457	500	541
WED1233		330	348	381	406	440	456	464	500	510	557	603
WED1236		339	357	390	417	452	470	475	513	525	572	619
WED1239		360	378	414	443	478	496	506	545	556	605	655
WED1242		378	400	437	469	507	526	536	577	590	640	693

- Door panel kits include Wall End Panel Skin, unattached door(s), and attachment screws. Field installation required.
- Custom door sizes not available.

*Width shown in each image is panel width. For Full Overlay doors, total door width is 1/2" greater than panel width. When installed on the side of a cabinet as intended, the Full Overlay door will extend over the cabinet face frame edge. Partial Overlay doors have a 1" reveal, so they would not overlap the frame.

Custom Modifications

ID	RD

Door Options

MFO
•

DECORATIVE DOOR PANEL KIT, BASE END

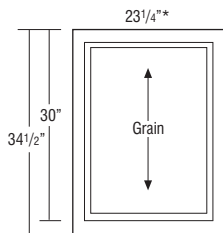

BESD	471	493	544	583	630	653	666	716	731	797	864
------	-----	-----	-----	-----	-----	-----	-----	-----	-----	-----	-----

- Door panel kits include Base End Panel Skin, unattached door(s), and attachment screws. Field installation required.
- Custom door sizes not available.

*Width shown in each image is panel width. For Full Overlay doors, total door width is 1/2" greater than panel width. When installed on the side of a cabinet as intended, the Full Overlay door will extend over the cabinet face frame edge. Partial Overlay doors have a 1" reveal, so they would not overlap the frame.

Custom Modifications

ID	RD

DECORATIVE DOOR PANEL KIT, TALL END

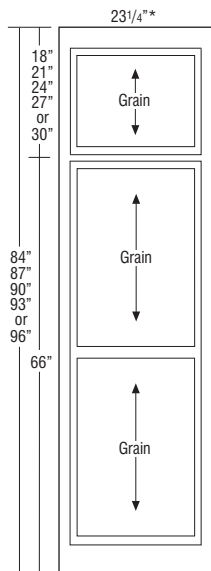

TED2484SD	1122	1168	1271	1337	1440	1490	1519	1629	1663	1791	1924
TED2487SD	1153	1200	1308	1378	1483	1535	1565	1676	1710	1845	1983
TED2490SD	1162	1209	1316	1387	1495	1547	1575	1687	1722	1857	1996
TED2493SD	1201	1250	1364	1437	1547	1602	1632	1751	1787	1926	2074
TED2496SD	1201	1250	1364	1437	1547	1602	1632	1751	1787	1926	2074

- Door panel kits include Tall End Panel Skin, unattached door(s), and attachment screws. Field installation required.
- Custom door sizes not available.
- Tall mitered door styles and laminate door styles will feature one center panel, other styles will feature two center panels.

*Width shown in each image is panel width. For Full Overlay doors, total door width is 1/2" greater than panel width. When installed on the side of a cabinet as intended, the Full Overlay door will extend over the cabinet face frame edge. Partial Overlay doors have a 1" reveal, so they would not overlap the frame.

Custom Modifications

ID	RD

Door Options

MFO
•

TABLE OF CONTENTS – MOULDINGS

- Stack Moulding Kits132
- Crown Mouldings135
- Starter Mouldings137
- Accent Mouldings137
- Toe Mouldings138
- Light Rails138
- Corner Mouldings139
- Valances140

DESCRIPTION	MODEL	PRICE
STACK MOULDING KITS		

- Moulding stacks do not ship assembled; field assembly is required. Assembly instructions can be viewed in 20/20 spec pages and will also ship with moulding kits.
 - When ordered as a kit, only one finish can be specified. To order with more than one finish, moulding pieces must be ordered separately.
 - Moulding stacks include Assembly Instructions. Cleats and finish nails not included.
- How to place a stack moulding in 20/20:
 - Moulding
 - Top Mouldings or Bottom Mouldings
 - Stacked Mouldings
 - Drag and drop desired moulding stack onto wall cabinets
 - Mouldings specified as 8' nominal length have a usable length range of 93" up to 99". Be sure to order the correct amount of moulding length to work around required cuts with minimal butt joints.

MOULDING STACK 1

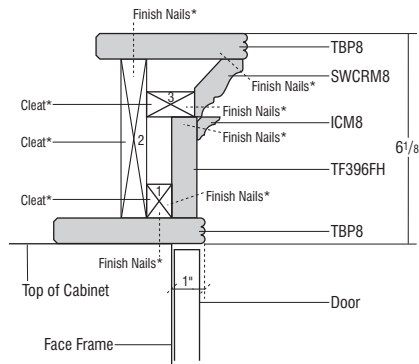
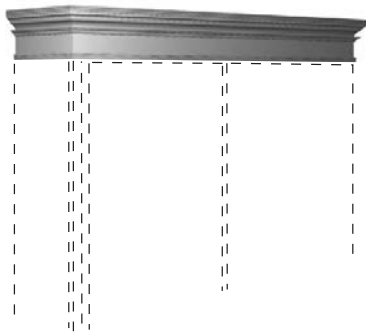

STKMLD1

1097

- Not recommended for use when taking application to the ceiling.

Species Availability

	Cherry	Maple	Oak	Laminate	Painted
TBP8	•	•	•	Painted	•
SWCRM8	•	•	•	Painted	•
ICM8	•	•	•	Painted	•
TF396FH	•	•	•	Painted	•

*Cleats and finish nails not included.

MOULDING STACK 6

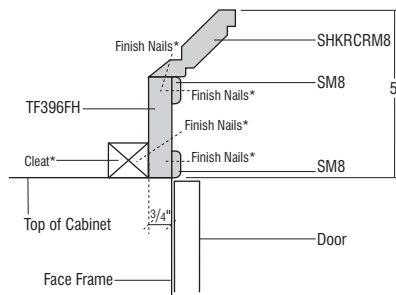
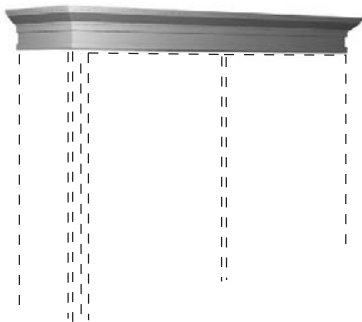

STKMLD6

564

- Not recommended for use when taking application to the ceiling.

Species Availability

	Cherry	Maple	Oak	Laminate	Painted
SHKRCRM8	•	•	•	Painted	•
SM8	•	•	•	Painted	•
TF396FH	•	•	•	Painted	•

*Cleats and finish nails not included.

DESCRIPTION

MODEL

PRICE

MOULDING STACK 11

STKMLD11

799

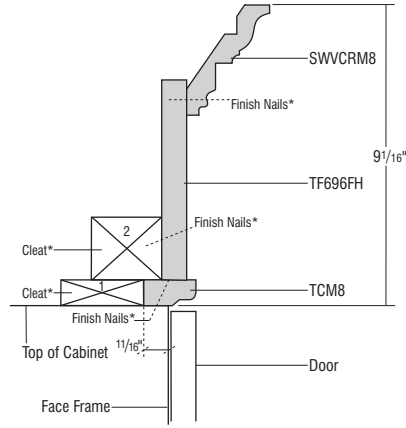

Species Availability

	Cherry	Maple	Oak	Laminate	Painted
SWCRM8	•	•	•	Painted	•
TF696FH	•	•	•	Painted	•
TCM8	•	•	•	Painted	•

*Cleats and finish nails not included.

MOULDING STACK 13

STKMLD13

372

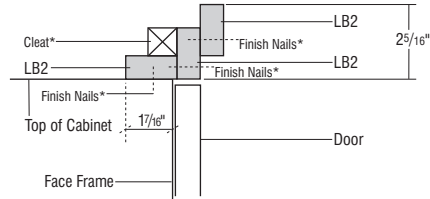
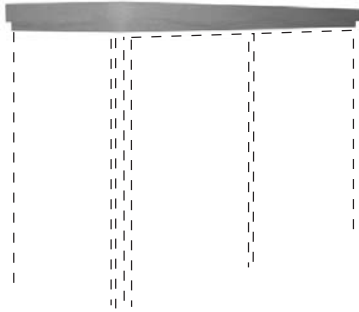

Species Availability

	Cherry	Maple	Oak	Laminate	Painted
LB2	•	•	•	Painted	•

*Cleats and finish nails not included.

MOULDING STACK 14

STKMLD14

480

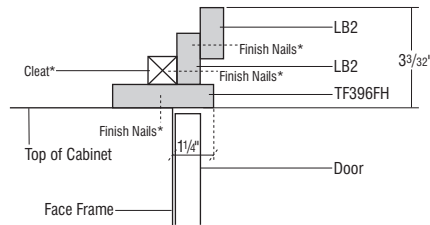
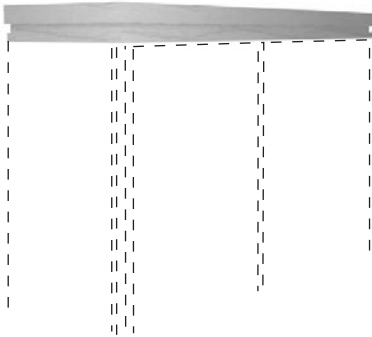

Species Availability

	Cherry	Maple	Oak	Laminate	Painted
LB2	•	•	•	Painted	•
TF396FH	•	•	•	Painted	•

*Cleats and finish nails not included.

MOULDING STACK 20

STKMLD20

410

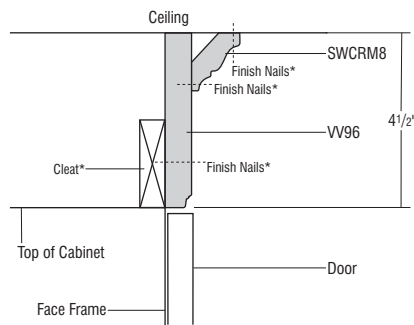
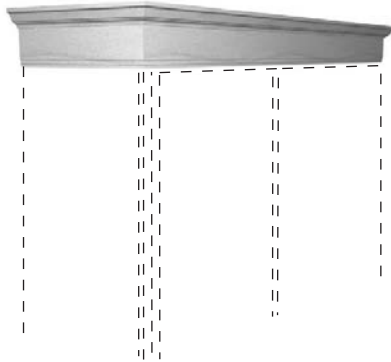

Species Availability

	Cherry	Maple	Oak	Laminate	Painted
SWCRM8	•	•	•	Painted	•
VV96	•	•	•	Painted	•

*Cleats and finish nails not included.

DESCRIPTION

MODEL

PRICE

MOULDING STACK 21

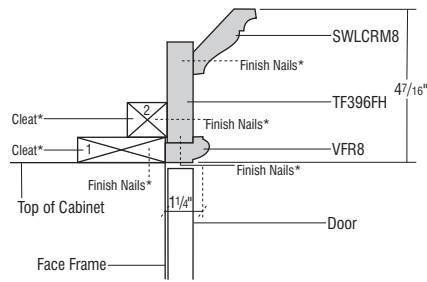
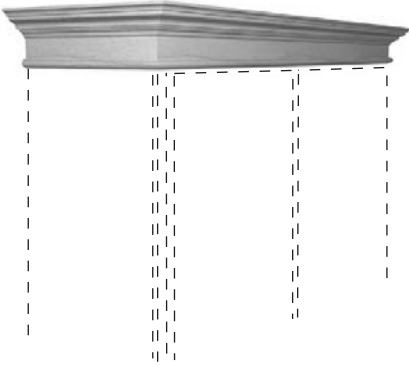

STKMLD21

614

Species Availability

	Cherry	Maple	Oak	Laminate	Painted
SWLCRM8	•	•	•	Painted	•
TF396FH	•	•	•	Painted	•
VFR8	•	•	•	Painted	•

*Cleats and finish nails not included.

MOULDING STACK 22

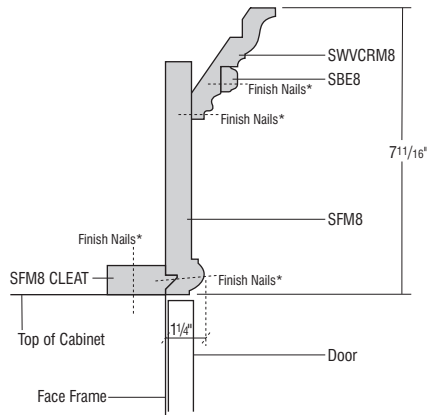
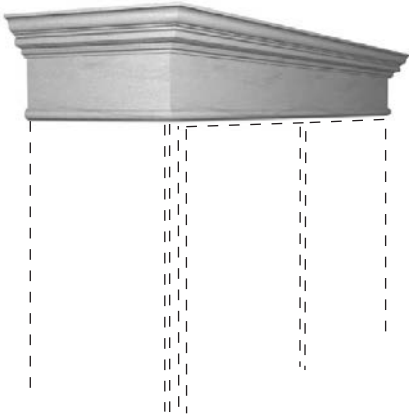

STKMLD22

890

Species Availability

	Cherry	Maple	Oak	Laminate	Painted
SWVCRM8	•	•	•	Painted	•
SBE8	•	•	•	Painted	•
SFM8	•	•	•	Painted	•

*Cleats and finish nails not included.

MOULDING STACK 24

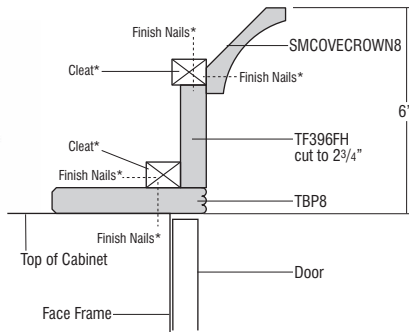
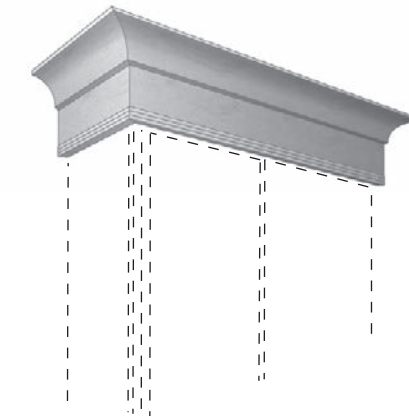

STKMLD24

862

- Not recommended for use when taking application to the ceiling.

Species Availability

	Cherry	Maple	Oak	Laminate	Painted
SMCOVECROWN8	•	•	•	Painted	•
TF396FH	•	•	•	Painted	•
TBP8	•	•	•	Painted	•

*Cleats and finish nails not included.

MOULDING STACK 25

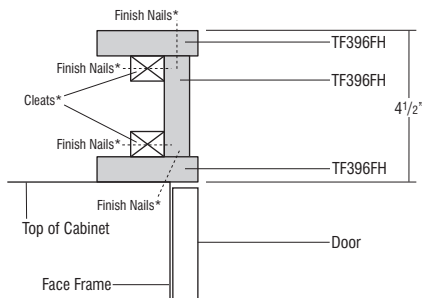
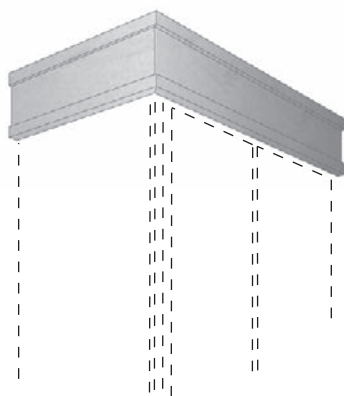

STKMLD25

896

- Not recommended for use when taking application to the ceiling.

Species Availability

	Cherry	Maple	Oak	Laminate	Painted
TF396FH	•	•	•	Painted	•

*Cleats and finish nails not included.

MOULDING SPECIFICATIONS

Mouldings specified as 8' nominal length have a usable length range of 93" up to 99". Be sure to order the correct amount of moulding length to work around required cuts with minimal butt joints.

DESCRIPTION MODEL PRICE

CROWN MOULDING

CLASSIC TALL CROWN



CLTCROWN8

403

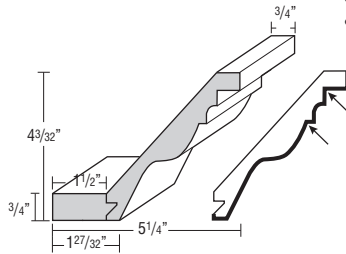

- One 8' section
- Cleat shipped unattached can be used for top mount or face frame applications. For top mount applications on stained finishes, it is not recommended to pull the moulding forward with the cleat visible due to possible color variation with the face frame and moulding.

Species Availability

Cherry	Maple	Oak	Laminate	Painted
•	•	•	Painted	•

CORNICE TALL CROWN



COTCROWN8

403

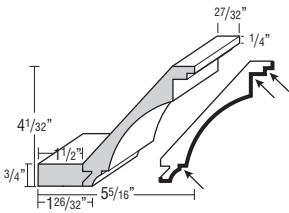

- One 8' section
- Cleat shipped unattached, can be used for top mount or face frame applications. For top mount applications on stained finishes, it is not recommended to pull the moulding forward with the cleat visible due to possible color variation with the face frame and moulding.

Species Availability

Cherry	Maple	Oak	Laminate	Painted
•	•	•	Painted	•

COVE CROWN



COVECROWN8

403

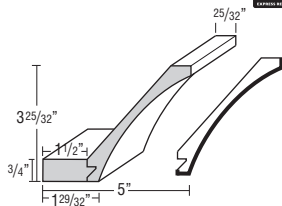

- One 8' section
- Cleat shipped unattached can be used for top mount or face frame applications. For top mount applications on stained finishes, it is not recommended to pull the moulding forward with the cleat visible due to possible color variation with the face frame and moulding.

Species Availability

Cherry	Maple	Oak	Laminate	Painted
•	•	•	Painted	•

INSERT CROWN



INSCROWN8

448

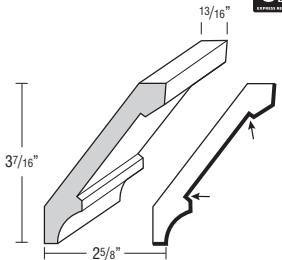

- One 8' section.

Species Availability

Cherry	Maple	Oak	Laminate	Painted
•	•	•	Painted	•

LARGE STRAIGHT ANGLE CROWN



LSACROWN8

313

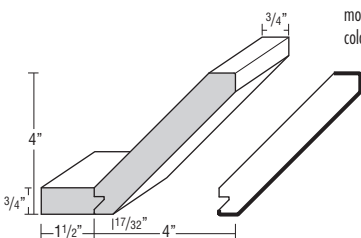

- One 8' section.
- Cleat shipped unattached can be used for top mount or face frame applications. For top mount applications on stained finishes, it is not recommended to pull the moulding forward with the cleat visible due to possible color variation with the face frame and moulding.

Species Availability

Cherry	Maple	Oak	Laminate	Painted
•	•	•	Painted	•

DESCRIPTION

MODEL

PRICE

MEDIUM STRAIGHT ANGLE CROWN



MSACROWN8

283

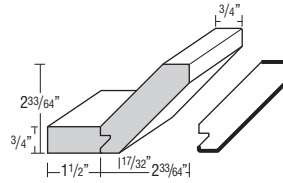

- One 8' section.
- Cleat shipped unattached can be used for top mount or face frame applications. For top mount applications on stained finishes, it is not recommended to pull the moulding forward with the cleat visible due to possible color variation with the face frame and moulding.

Species Availability

Cherry	Maple	Oak	Laminate	Painted
•	•	•	Painted	•

STRAIGHT ANGLE CROWN



SACROWN8

264

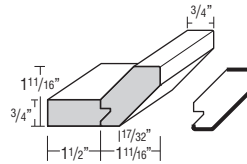

- One 8' section.
- Cleat shipped unattached can be used for top mount or face frame applications. For top mount applications on stained finishes, it is not recommended to pull the moulding forward with the cleat visible due to possible color variation with the face frame and moulding.

Species Availability

Cherry	Maple	Oak	Laminate	Painted
•	•	•	Painted	•

TALL CROWN



MTCROWN8

283

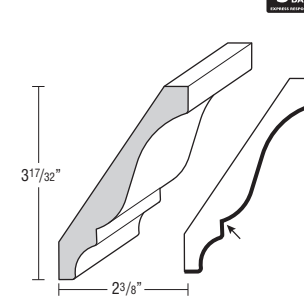

- One 8' section.

Species Availability

Cherry	Maple	Oak	Laminate	Painted
•	•	•	Painted	•

SHAKER CROWN



SHKRCRM8

204

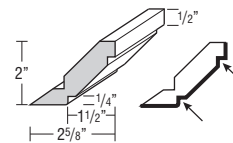

- Top mount moulding.
- One 8' section.

Species Availability

Cherry	Maple	Oak	Laminate	Painted
•	•	•	Painted	•

LARGE SHAKER CROWN



LSHAKER8

204

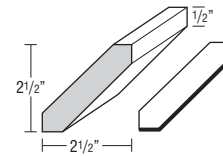

- One 8' section.

Species Availability

Cherry	Maple	Oak	Laminate	Painted
•	•	•	Painted	•

SMALL COVE CROWN MOULDING



SMCOVECROWN8

317

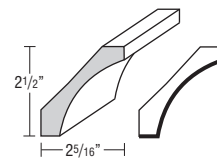

- One 8' section.

Species Availability

Cherry	Maple	Oak	Laminate	Painted
•	•	•	Painted	•

Finished edges indicated by bold lines on side view drawings.
Glazed edges indicated by arrows on side view drawings.

DESCRIPTION MODEL PRICE

SMALL CROWN



SCM8

146

- Face mounts on Partial Overlay doors. May be face mounted on Full Overlay if used with a cleat.
- One 8" section.
- Moulding can be used as standard or inverted.

Species Availability

Cherry	Maple	Oak	Laminate	Painted
•	•	•	Painted	•

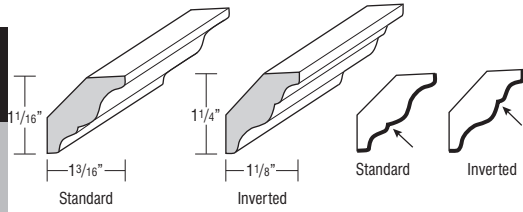

SOLID-WOOD CROWN



SWCRM8

156

- Face mounts on Partial Overlay doors. May be face mounted on Full Overlay if used with a cleat.
- One 8" section.
- Moulding can be used as standard or inverted.

Species Availability

Cherry	Maple	Oak	Laminate	Painted
•	•	•	Painted	•

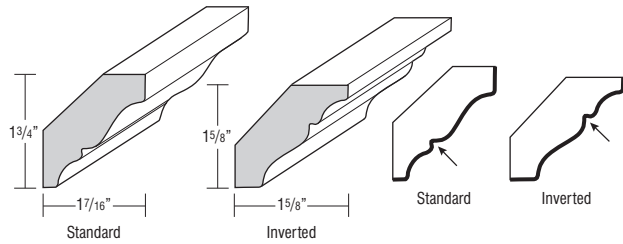

SOLID-WOOD LARGE CROWN



SWLCRM8

264

- Face mounts on Partial Overlay doors. May be face mounted on Full Overlay if used with a cleat.
- One 8" section.
- Moulding can be used as standard or inverted.

Species Availability

Cherry	Maple	Oak	Laminate	Painted
•	•	•	Painted	•

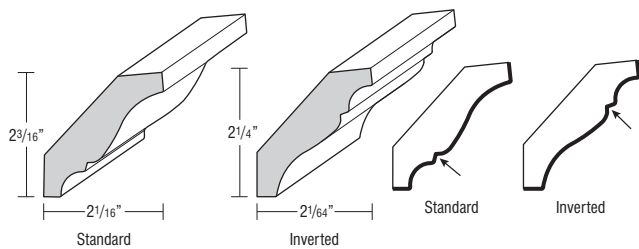

DESCRIPTION MODEL PRICE

SOLID-WOOD TALL CROWN



SWTCRM8

283

- Face mounts on Partial Overlay doors. May be face mounted on Full Overlay if used with a cleat.
- One 8" section.
- Moulding can be used as standard or inverted.

Species Availability

Cherry	Maple	Oak	Laminate	Painted
•	•	•	Painted	•

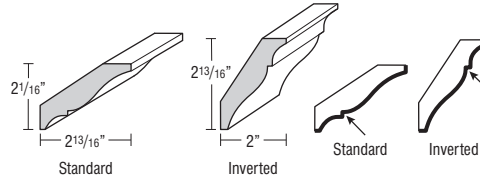

SOLID-WOOD VICTORIAN CROWN



SWVCRM8

303

- Face mounts on Partial Overlay doors. May be face mounted on Full Overlay if used with a cleat.
- One 8" section.

Species Availability

Cherry	Maple	Oak	Laminate	Painted
•	•	•	Painted	•

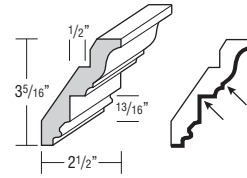

Finished edges indicated by bold lines on side view drawings.
Glazed edges indicated by arrows on side view drawings.

DESCRIPTION MODEL PRICE
STARTER MOULDING

SOFFIT FILLER MOULDING



SFM8

472

- One 8' section.
- Cleat shipped unattached, can be used for top mount or face frame applications. For top mount applications on stained finishes, it is not recommended to pull the moulding forward with the cleat visible due to possible color variation with the face frame and moulding.

Species Availability

Cherry	Maple	Oak	Laminate	Painted
•	•	•	Painted	•

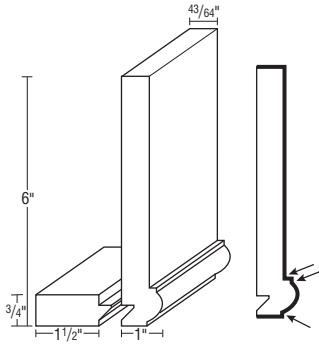

STARTER MOULDING



STR8

433

- One 8' section.
- Attached cleat for top-mount application.

Species Availability

Cherry	Maple	Oak	Laminate	Painted
•	•	•	Painted	•

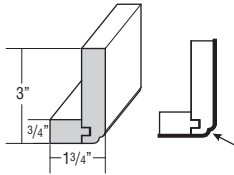

STARTER MOULDING, SHAKER



STRS8

419

- One 8' section.
- Attached cleat for top-mount application.

Species Availability

Cherry	Maple	Oak	Laminate	Painted
•	•	•	Painted	•

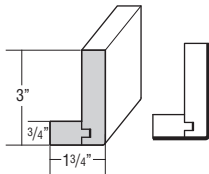

ACCENT MOULDING

CABINET PANEL EDGE



CPE8

186

- One 8' section.
- Use CPE8 with 1/4" skin to create flush cabinet bottoms.

Species Availability

Cherry	Maple	Oak	Laminate	Painted
•	•	•	Painted	•

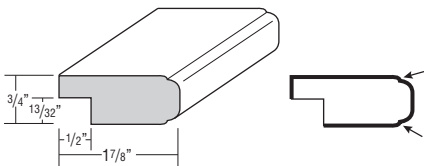

TRADITIONAL COUNTERTOP EDGE



TCM8

99

- One 8' section.

Species Availability

Cherry	Maple	Oak	Laminate	Painted
•	•	•	Painted	•

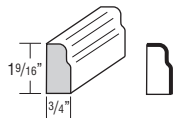

DESCRIPTION MODEL PRICE

BATTEN



BATTEN8

77

- One 8' section.

Species Availability

Cherry	Maple	Oak	Laminate	Painted
•	•	•	Painted	•

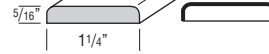

FLAT SCRIBE



SM8

64

- One 8' section.

Species Availability

Cherry	Maple	Oak	Laminate	Painted
•	•	•	Painted	•

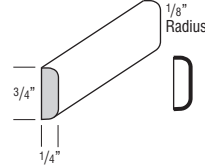

LIBRARY MOULDING



LBRM

283

- One 8' section.
- Use Library Moulding as a part of a moulding stack or vertically to cover seams in a row of bookcases.

Species Availability

Cherry	Maple	Oak	Laminate	Painted
•	•	•	Painted	•

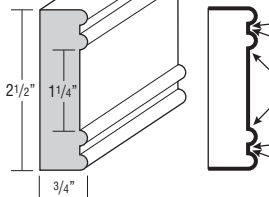

MIRROR FRAME



WMF8

144

- One 8' section.
- Pre-grooved.

Species Availability

Cherry	Maple	Oak	Laminate	Painted
•	•	•	Painted	•

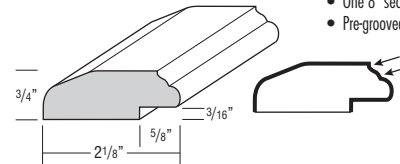

OGEE EDGE



OGEE8

123

- One 8' section.

Species Availability

Cherry	Maple	Oak	Laminate	Painted
•	•	•	Painted	•

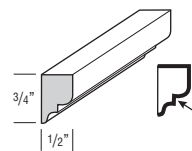

SINGLE BEAD EDGE



SBE8

115

- One 8' section.

Species Availability

Cherry	Maple	Oak	Laminate	Painted
•	•	•	Painted	•

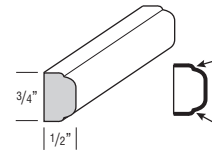

SMALL SCRIBE



SCRIBE8

50

- One 8' section.

Species Availability

Cherry	Maple	Oak	Laminate	Painted
•	•	•	Painted	•

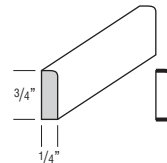

Finished edges indicated by bold lines on side view drawings.
 Glazed edges indicated by arrows on side view drawings.

DESCRIPTION MODEL PRICE

SOFFIT TRIM MOULDING



TSTM8 189

- One 8' section.

Species Availability

Cherry	Maple	Oak	Laminate	Painted
•	•	•	Painted	•

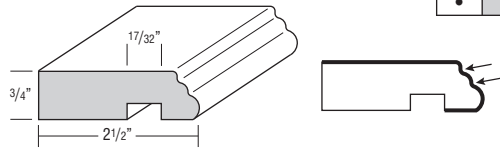

TRIPLE BEAD EDGE



TBEM 128

- One 8' section.

Species Availability

Cherry	Maple	Oak	Laminate	Painted
•	•	•	Painted	•

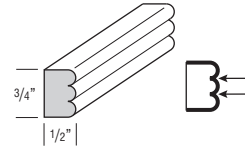

TRIPLE BEAD PILASTER



TBP8 313

- Finished beaded front and two 4 1/2" sides.
- Can be used vertically between cabinets for an inset look.
- One 8' section.

Species Availability

Cherry	Maple	Oak	Laminate	Painted
•	•	•	Painted	•

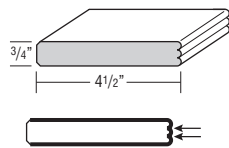

TOE MOULDING

BASEBOARD



BBM8 274

- One 8' section.
- BBM8 can be used in place of standard toekick to provide a surface for glaze hang-up on premium finishes.

Species Availability

Cherry	Maple	Oak	Laminate	Painted
•	•	•	Painted	•

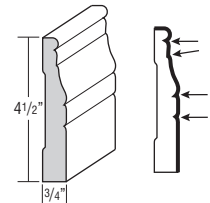

BASEBOARD - SHAKER



BBMSH8 284

- One 8' section.

Species Availability

Cherry	Maple	Oak	Laminate	Painted
•	•	•	Painted	•

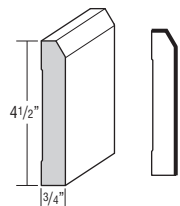

BASEBOARD - FURNITURE



BBMFB8 274

- One 8' section.

Species Availability

Cherry	Maple	Oak	Laminate	Painted
•	•	•	Painted	•

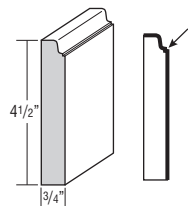

DESCRIPTION MODEL PRICE

TOEBOARDS



TB8LAM14 45

TB8WD14 50

- TB8LAM14 is 1/4" laminated furniture board (White only).
- TB8WD14 in Stains: 1/4" thick veneered furniture board.
- TB8WD14 in Paints: 1/4" thick veneered or solid furniture board.
- One 8' section.
- Remember to order Toekick Cap for each exposed end of toeboard.

Species Availability

Cherry	Maple	Oak	Laminate	Painted
•	•	•	Painted	•

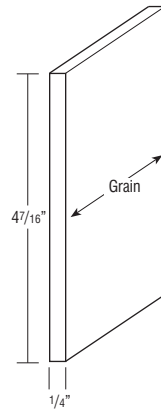

TOEKICK CAP



TKC 33

- All finishes available.
- Sold in pairs.

Species Availability

Cherry	Maple	Oak	Laminate	Painted
Maple	•	•	Painted	•

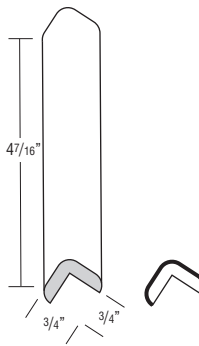

LIGHT RAILS

CAP MOULDING



CAPM 145

- One 8' section.

Species Availability

Cherry	Maple	Oak	Laminate	Painted
•	•	•	Painted	•

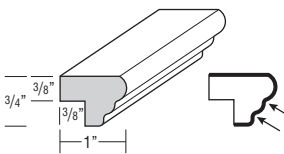

NEW CABINET PANEL EDGE SQUARE



CPES 140

- One 8' section.
- Standard application must be shimmed at the notch or used with an under-cabinet skin if used with full overlay styles. Inverted application does not require a shim or panel.
- Standard application can be used as a top-mount moulding.

Species Availability

Cherry	Maple	Oak	Laminate	Painted
•	•	•	Painted	•

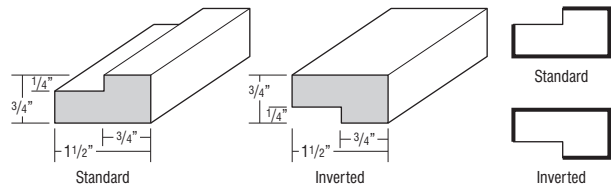

Finished edges indicated by bold lines on side view drawings.
Glazed edges indicated by arrows on side view drawings.

DESCRIPTION MODEL PRICE

LIGHT RAIL CAP MOULDING



SOFFITA 118

- One 8' section.
- Must be shimmed at the notch or used with an under-cabinet skin if used with full overlay styles.

Species Availability

Cherry	Maple	Oak	Laminate	Painted
•	•	•	Painted	•

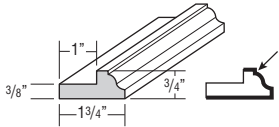

LIGHT RAIL CAP MOULDING



SOFFITE 118

- One 8' section.
- Must be shimmed at the notch or used with an under-cabinet skin if used with full overlay styles.

Species Availability

Cherry	Maple	Oak	Laminate	Painted
•	•	•	Painted	•

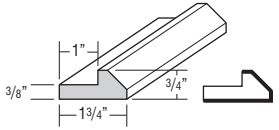

LIGHT BAFFLE



LB2 124

- One 8' section.

Species Availability

Cherry	Maple	Oak	Laminate	Painted
•	•	•	Painted	•

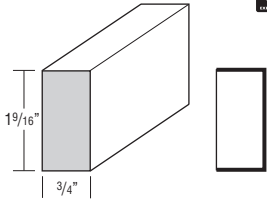

FURNITURE BASE LIGHT RAIL MOULDING



FBLR8 145

- One 8' section.

Species Availability

Cherry	Maple	Oak	Laminate	Painted
•	•	•	Painted	•

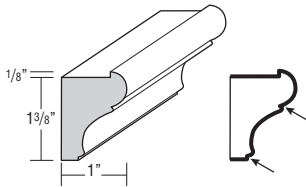

SMALL LIGHT RAIL MOULDING



SMLR 452

- One 8' section.

Species Availability

Cherry	Maple	Oak	Laminate	Painted
•	•	•	Painted	•

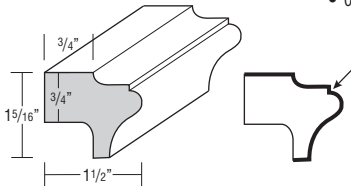

LIGHT RAIL MOULDING



LRM 518

- One 8' section.

Species Availability

Cherry	Maple	Oak	Laminate	Painted
•	•	•	Painted	•

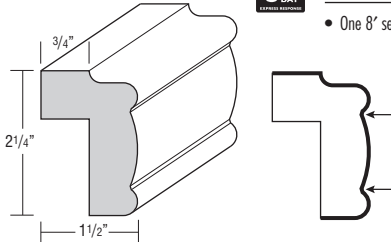

VALLEY FORGE



VFR8 118

- One 8' section.
- Must be shimmed at the notch or used with an under-cabinet skin if used with full overlay styles.

Species Availability

Cherry	Maple	Oak	Laminate	Painted
•	•	•	Painted	•

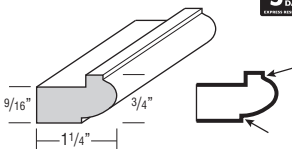

DESCRIPTION MODEL PRICE

CORNER MOULDINGS

INSIDE CORNER



ICM8 83

- One 8' section.

Species Availability

Cherry	Maple	Oak	Laminate	Painted
•	•	•	Painted	•

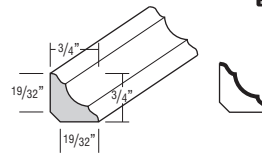

LARGE OUTSIDE CORNER



LOSC8 136

- One 8' section.

Species Availability

Cherry	Maple	Oak	Laminate	Painted
•	•	•	Painted	•

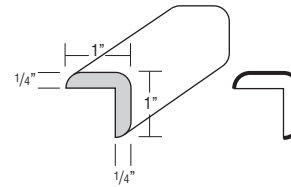

OUTSIDE CORNER



OCM8 77

- One 8' section.

Species Availability

Cherry	Maple	Oak	Laminate	Painted
•	•	•	Painted	•

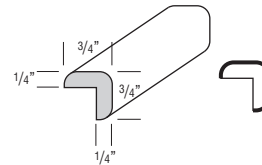

OUTSIDE CORNER 135°



OC135 123

- One 8' section.

Species Availability

Cherry	Maple	Oak	Laminate	Painted
•	•	•	Painted	•

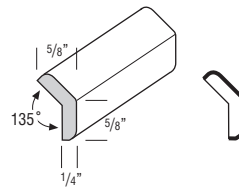

QUARTER ROUND MOULDING



QRM 81

- One 8' section.

Species Availability

Cherry	Maple	Oak	Laminate	Painted
•	•	•	Painted	•

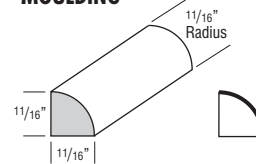

SHOE - CONVEX INSIDE CORNER



SHM8 73

- One 8' section.

Species Availability

Cherry	Maple	Oak	Laminate	Painted
•	•	•	Painted	•

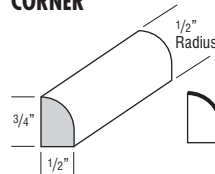

Finished edges indicated by bold lines on side view drawings.
Glazed edges indicated by arrows on side view drawings.

DESCRIPTION MODEL PRICE

VALANCES

ARCHED VALANCE		AV36	128
		AV48	155
		AV60	176
		AV72	214

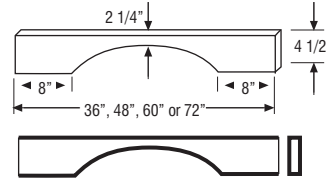

- Side shoulders are 8" wide (6" trimmable each end).
- Bottom edge has 3/16" radius.
- 3/4" thick.

Species Availability

Cherry	Maple	Oak	Laminate	Painted
•	•	•	Painted	•

FURNITURE VALANCE		FV36	121
		FV48	146
		FV60	166
		FV72	199

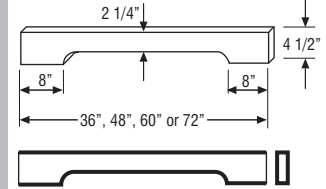

- Side shoulders are 8" wide (6" trimmable each end).
- Bottom edge has 3/16" radius profile on face.
- 3/4" thick.

Species Availability

Cherry	Maple	Oak	Laminate	Painted
•	•	•	Painted	•

RAISED PANEL ARCH VALANCE		JRPV36	1220
		JRPV42	1278

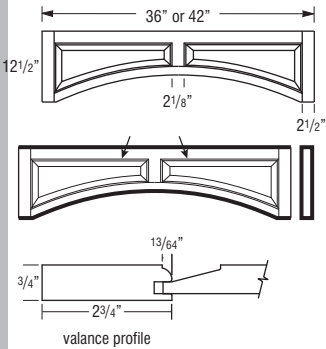

- Trimmable up to 1 3/4" per side.
- Center height 8".
- Raised panel profile is unique to this item and does not match any door style.
- Ends are pocket drilled for installation to adjacent cabinet frames.

Species Availability

Cherry	Maple	Oak	Laminate	Painted
•	•	•	Painted	•

STRAIGHT VALANCE		VV48	124
		VV96	254

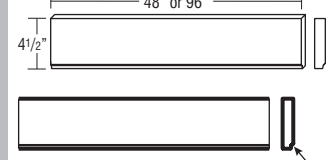

- Trimmable.
- Profiled bottom edge
- 3/4" thick.

Species Availability

Cherry	Maple	Oak	Laminate	Painted
•	•	•	Painted	•

TABLE OF CONTENTS – EMBELLISHMENTS

Decorative Legs140
 Decorative Feet143
 Decorative Corbels & Shelf Supports144
 Shelves144
 Decorative Hardware146

DESCRIPTION MODEL PRICE

DECORATIVE LEGS		ENGLISH ISLAND COLUMN, 5" WIDE, 35 1/4" HIGH	ENGLISLCOLUMN	1425

- Trimmable.

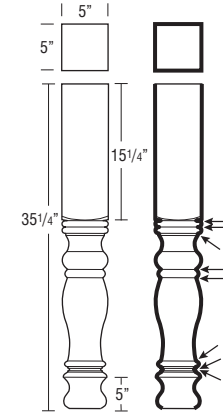

Species Availability

Cherry	Maple	Oak	Laminate	Painted
•	•	•	Painted	•

ESTATE LEG, SMALL		JESTATELEGS	793

- Trimmable.

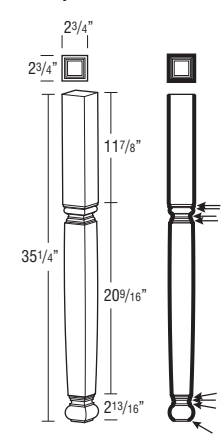

Species Availability

Cherry	Maple	Oak	Laminate	Painted
•	•	•	Painted	•

Finished edges indicated by bold lines on side view drawings.
 Glazed edges indicated by arrows on side view drawings.

DESCRIPTION MODEL PRICE

**ISLAND LEG, 2-SIDED,
35 1/4" HIGH**



2SISLEG

905

- Trimable.

Species Availability

Cherry	Maple	Oak	Laminate	Painted
•	•	•	Painted	•

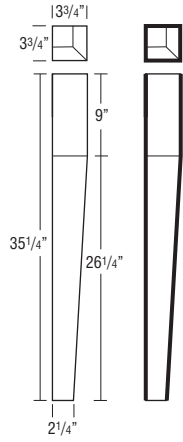

Taper 2 Sides

**ISLAND LEG, 4-SIDED,
35 1/4" HIGH**



4SISLEG

1161

- Trimable.

Species Availability

Cherry	Maple	Oak	Laminate	Painted
•	•	•	Painted	•

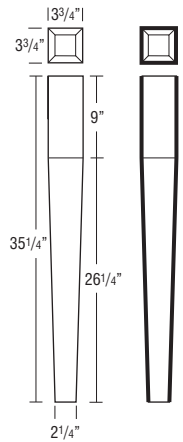

Taper 4 Sides

**METRO ISLAND COLUMN,
34 5/8" HIGH**



METISLCOLUMN

1150

- Trimable.
- Leg is designed with three pieces joined together.

Species Availability

Cherry	Maple	Oak	Laminate	Painted
•	•	•	Painted	•

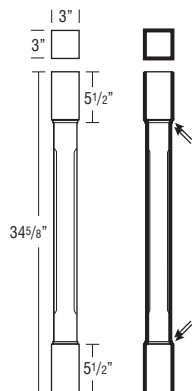

DESCRIPTION MODEL PRICE

**MISSION LEG,
34 1/2" HIGH**



DLEGMISSION

907

- Trimable.

Species Availability

Cherry	Maple	Oak	Laminate	Painted
•	•	•	Painted	•

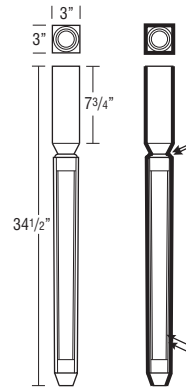

**SQUARE ISLAND
LEG, 3" x 3",
35 1/4" HIGH**



JSQISLLEG3

585

- Trimable.

Species Availability

Cherry	Maple	Oak	Laminate	Painted
•	•	•	Painted	•

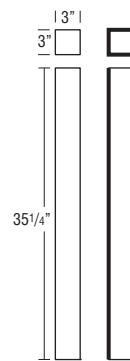

**SQUARE ISLAND
LEG, 4" x 4",
35 1/4" HIGH**



JSQISLLEG4

877

- Trimable.

Species Availability

Cherry	Maple	Oak	Laminate	Painted
•	•	•	Painted	•

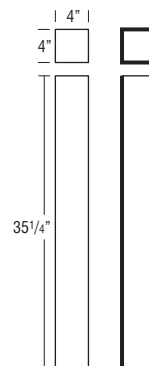

Finished edges indicated by bold lines on side view drawings.
Glazed edges indicated by arrows on side view drawings.

DESCRIPTION MODEL PRICE

SQUARE ISLAND LEG, 5" x 5", 35 1/4" HIGH



JSQISLEGS

965

- Trimmable.

Species Availability

Cherry	Maple	Oak	Laminate	Painted
•	•	•	Painted	•

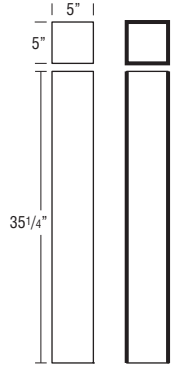

TURNED POST ISLAND LEG, 35 1/4" HIGH



TURNEDPOST

793

- Trimmable.

Species Availability

Cherry	Maple	Oak	Laminate	Painted
•	•	•	Painted	•

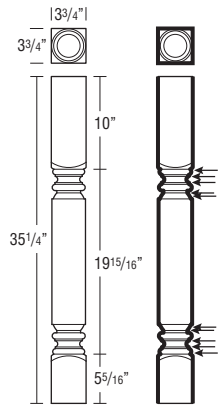

ISLAND LEG TAPERED, 35 1/4" HIGH



ISLEGTPRD

769

- Trimmable.

Species Availability

Cherry	Maple	Oak	Laminate	Painted
•	•	•	Painted	•

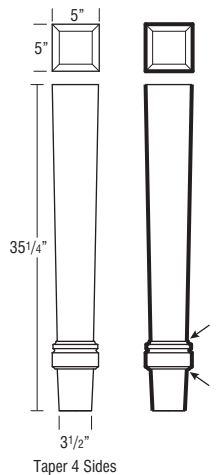

DESCRIPTION MODEL PRICE

ENGLISH COUNTRY LEG, 35 1/4" HIGH



JENGNTYLEG

882

- Trimmable.

Species Availability

Cherry	Maple	Oak	Laminate	Painted
•	•	•	Painted	•

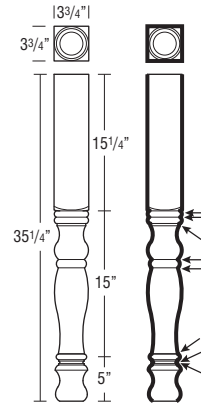

SPOOL LEG, 34 1/2" HIGH



SPLEG

1033

- Trimmable.

Species Availability

Cherry	Maple	Oak	Laminate	Painted
•	•	•	Painted	•

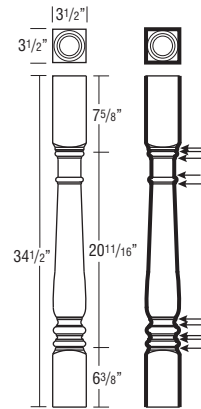

Finished edges indicated by bold lines on side view drawings.
Glazed edges indicated by arrows on side view drawings.

DESCRIPTION MODEL PRICE
DECORATIVE FEET

CRAFTSMAN FOOT, 4 1/2" HIGH



JCRAFTFOOT

185

- Trimable.

Species Availability

Cherry	Maple	Oak	Laminate	Painted
•	•	•	Painted	•

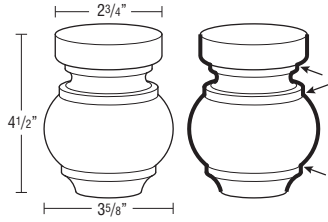

KENSINGTON BUN FOOT, 4 1/2" HIGH



JCRBUNFOOT

185

- Trimable.

Species Availability

Cherry	Maple	Oak	Laminate	Painted
•	•	•	Painted	•

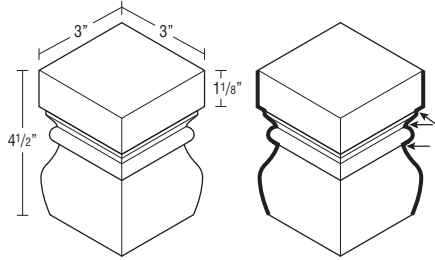

LILLE FOOT, 4 1/2" HIGH



LIFOOT

431

- Recommended for applications without toekicks.

Species Availability

Cherry	Maple	Oak	Laminate	Painted
•	•	•	Painted	•

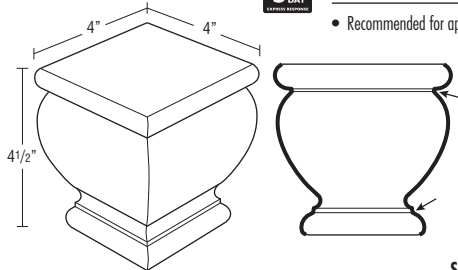

DESCRIPTION MODEL PRICE

TAPERED LEG, 6" HIGH



TAPLGL

283

- Trimable.
- Tapered on two sides.

Species Availability

Cherry	Maple	Oak	Laminate	Painted
•	•	•	Painted	•

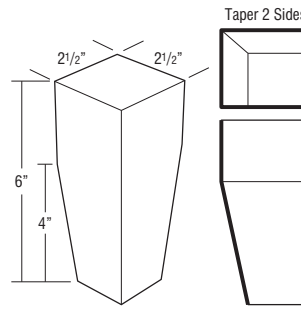

TOEKICK TULIP FOOT, 4 5/8" HIGH



TKTLFOOT

515

- Trimable.

Species Availability

Cherry	Maple	Oak	Laminate	Painted
•	•	•	Painted	•

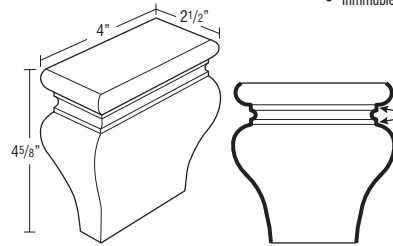

TULIP FOOT, 4 5/8" HIGH



TLFOOT

479

- Trimable.

Species Availability

Cherry	Maple	Oak	Laminate	Painted
•	•	•	Painted	•

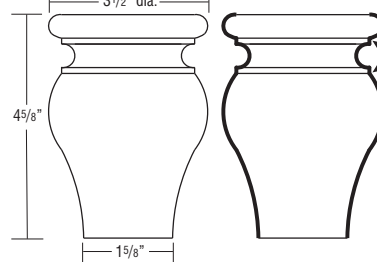

Finished edges indicated by bold lines on side view drawings.
 Glazed edges indicated by arrows on side view drawings.

DESCRIPTION MODEL PRICE
DECORATIVE CORBELS & SHELF SUPPORTS

9" ART CORBEL



CORBELART9

660

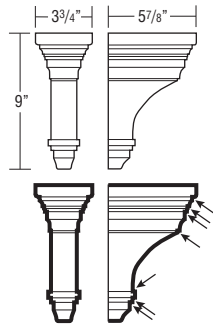

• Not intended for cabinet or freestanding countertop support. For substantial weight support, use a floor mounted support such as a Decorative Leg.

Species Availability

Cherry	Maple	Oak	Laminate	Painted
•	•	•	Painted	•

9" CLASSIC REVIVAL CORBEL



CORBELCR9

660

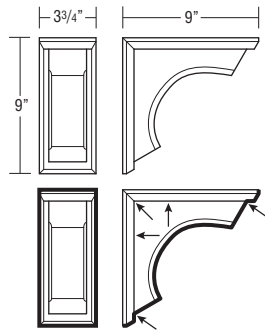

• Not intended for cabinet or freestanding countertop support. For substantial weight support, use a floor mounted support such as a Decorative Leg.

Species Availability

Cherry	Maple	Oak	Laminate	Painted
•	•	•	Painted	•

13" LARGE CORBEL



LGCORBEL

708

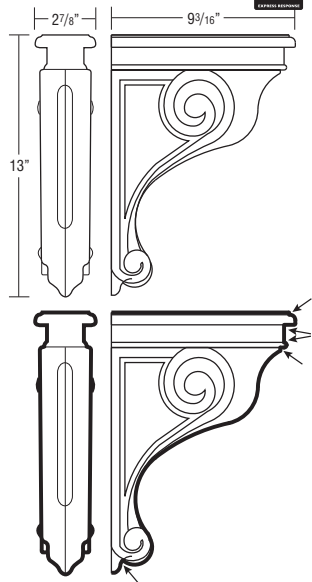

• Not intended for cabinet or freestanding countertop support. For substantial weight support, use a floor mounted support such as a Decorative Leg.

Species Availability

Cherry	Maple	Oak	Laminate	Painted
•	•	•	Painted	•

9" MISSION CORBEL



CORBELMIS9

647

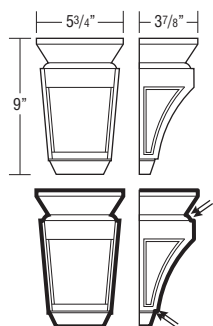

• Not intended for cabinet or freestanding countertop support. For substantial weight support, use a floor mounted support such as a Decorative Leg.

Species Availability

Cherry	Maple	Oak	Laminate	Painted
•	•	•	Painted	•

DESCRIPTION MODEL PRICE

5" OLD WORLD CORBEL

CORBELOWD5

428

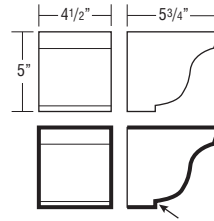

• Not intended for cabinet or freestanding countertop support. For substantial weight support, use a floor mounted support such as a Decorative Leg.

Species Availability

Cherry	Maple	Oak	Laminate	Painted
•	•	•	Painted	•

11 1/2" ARTS & CRAFTS BRACKET



JBRACKETART

470

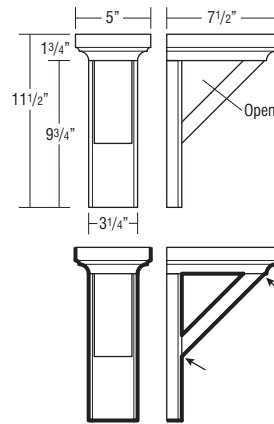

• Not intended for cabinet or freestanding countertop support. For substantial weight support, use a floor mounted support such as a Decorative Leg.

Species Availability

Cherry	Maple	Oak	Laminate	Painted
•	•	•	Painted	•

11 1/4" SNACK BAR SUPPORT



SBS

204

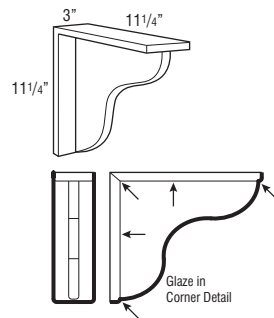

• Not intended for cabinet or freestanding countertop support. For substantial weight support, use a floor mounted support such as a Decorative Leg.

Species Availability

Cherry	Maple	Oak	Laminate	Painted
•	•	•	Painted	•

SHELVES

FLOATING SHELVES

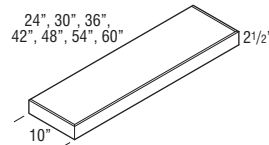

Maximum Weight Capacity per Shelf	
FS24	25 lbs.
FS30	31 lbs.
FS36	37 lbs.
FS42	43 lbs.
FS48	50 lbs.
FS54	56 lbs.
FS60	62 lbs.

FS24	496
FS30	564
FS36	637
FS42	707
FS48	778
FS54	846
FS60	916

• 3/4" thick solid-wood front, back and ends. 3/8" thick veneered Medium Density Fiberboard (MDF) top and bottom. When a Paint finish is specified, veneer may not be applied. Front and ends are mitered together.
• Not trimmable.
• Includes wood mounting plate with metal brackets. Once installed, mounting system is fully concealed.

Species Availability

Cherry	Maple	Oak	Laminate	Painted
	•		Painted	•

Finished edges indicated by bold lines on side view drawings.
Glazed edges indicated by arrows on side view drawings.

DESCRIPTION	MODEL	PRICE
-------------	-------	-------

**EXTERIOR SHELVES,
12" DEEP**

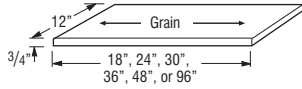

ES1218	98
ES1224	130
ES1230	163
ES1236	193
ES1248	250
ES1296 [†]	377

- 3/4" thick veneered furniture board finished both sides, and front and side edges (back edge is not finished).

[†]5 day Express Response not available on items greater than 48".

Custom Modifications

APW	ID	RD
•	•	•

Species Availability

Cherry	Maple	Oak	Laminate	Painted
•	•	•	Painted	•

**FULL DEPTH INTERIOR
SHELVES**

To Fit 12" and 24" Deep Cabinets

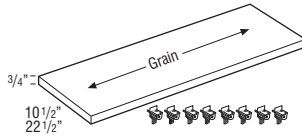

SK912	76
SK1212	76
SK1512	76
SK1812	92
SK2112	92
SK2412	92
SK2712	106
SK3012	106
SK3312	106
SK3612	123
SK3912	123
SK4212	123
SK4812	137

SK924	98
SK1224	98
SK1524	98
SK1824	115
SK2124	115
SK2424	115
SK2724	128
SK3024	128
SK3324	128
SK3624	145
SK3924	145
SK4224	145
SK4824	160

- SK__12 includes one 10 1/2" deep shelf, SK__24 includes one 22 1/2" deep shelf.
- Each kit includes 8 shelf pegs.
- Specify material when ordering.
- Full Depth Shelves will be shipped separate from the cabinet.

Custom Modifications

APW	MIP	RD
•	•	•

¹ Not available on SK__12

DESCRIPTION	MODEL	PRICE
-------------	-------	-------

**GLASS SHELF KIT,
12" DEEP**

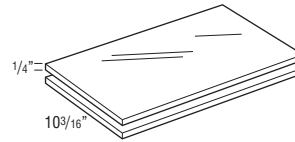

JGSK1212	171
JGSK1512	176
JGSK1812	182
JGSK2112	208
JGSK2412	218
JGSK2712	221
JGSK3012	226
JGSK3312	239
JGSK3612	251

- JGSK cannot be trimmed.
- Kit includes two 1/4" glass shelves.
- Example: JGSK1512 = 13 9/32" wide x 10 3/16" deep fits in W1530x12 Deep Cabinet.
- All glass shelf kits will be drop shipped separately from the cabinet order.
- Can support 15 lbs. per square foot.

**GLASS SHELF KIT,
DIAGONAL**

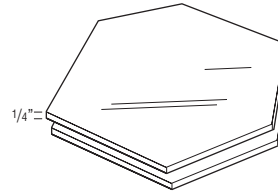

JGSKDW24 (Fits DW..2424)	344
JGSKDW27 (Fits DW..2727)	344

- JGSK cannot be trimmed.
- Kit includes two 1/4" glass shelves.
- Not available for 12"-27" high Diagonal Wall Cabinets. Shelf will not fit through door opening.
- All glass shelf kits will be drop shipped separately from the cabinet order.
- Can support 15 lbs. per square foot.

DECORATIVE HARDWARE — KNOBS AND PULLS

ANTIQUPE PEWTER



KNOBM206 18
D: 1 1/4"
P: 1 1/16"



PULLM364 23
C/C: 3"
L: 4 5/8"
W: 1 7/16"
P: 15/16"



PULLM475 17
C/C: 3 3/4"
L: 5"
W: 9/16"
P: 1"

BLACK



KNOBT1017 35
C/C: 1 1/4"
L: 2"
W: 11/16"
P: 1 1/4"
Pairs best with PULLT1015



PULLT1015 50
C/C: 7"
L: 8"
W: 11/16"
P: 1 1/2"
Pairs best with KNOBT1017



KNOB1912 43
D: 1 1/4"
P: 1 3/16"

D = Diameter
P = Projection (Hardware Depth)
L = Length
W = Width
B = Base
C/C = Center to Center

Installation screws included with each hardware piece.
Breakoff screws available for purchase separately as BRKOFFSCREW, see page 157.
Larger pulls may not be compatible with 5-piece drawer fronts on face frame openings of 9" wide or less.
See Door Style section for 5-piece drawer front dimensions when specifying decorative hardware.
For color images of decorative hardware, see company web site.

BLACK (cont'd)



KNOBH951 16
L: 1 3/4"
W: 1"
P: 1"
B: 1 1/16" x 1/2"



PULLH952 31
C/C: 3"
L: 4 1/4"
W: 1 1/2"
P: 11/16"



PULLM383 31
C/C: 5 1/16"
L: 6"
W: 1/2"
P: 1 1/16"



KNOBH136 14
L: 1 3/4"
W: 1/2"
P: 1 1/8"
B: 1/2"



PULLH130 16
C/C: 128mm
L: 6 3/8"
W: 7/16"
P: 1 1/8"



PULLH132 26
C/C: 224mm
L: 10"
W: 1/2"
P: 1 3/8"

BLACK IRON



KNOB1901 28
L: 1 7/16"
W: 1 1/4"
P: 1 1/8"
B: 15/16"



PULL1902 42
C/C: 128mm
L: 6 1/3"
W: 1 1/10"
P: 1 1/16"

BLACK MIST



KNOBH116 15
 L: 1 5/16"
 W: 1 1/4"
 P: 1 1/8"
 B: 3/8"



PULLH115 32
 C/C: 128mm
 L: 6 3/8"
 W: 1/2"
 P: 1"

CHROME



KNOB1906 43
 L: 1 1/16"
 W: 1 1/16"
 P: 1 1/8"
 B: 3/8"



PULL1905 58
 C/C: 128mm
 L: 6 3/8"
 W: 9/16"
 P: 1"



PULL1904 60
 C/C: 3 3/4"
 L: 5 1/4"
 W: 1"
 P: 1"

GOLD



KNOB1908 32
 L: 1 1/4"
 W: 1 1/4"
 P: 1"
 B: 3/8"
 Pairs best with PULL1907



PULL1907 52
 C/C: 160mm
 L: 6 7/10"
 W: 2/5"
 P: 1 1/5"
 Pairs best with KNOB1908



KNOB1909 31
 L: 1 1/4"
 W: 1 1/4"
 P: 1 1/8"
 B: 3/4"
 Pairs best with PULL1910 or PULL1911



PULL1910 64
 C/C: 224mm
 L: 9 9/16"
 W: 3/4"
 P: 1 5/16"
 Pairs best with KNOB1909 or PULL1911



PULL1911 58
 C/C: 192mm
 L: 8 3/8"
 W: 3/4"
 P: 1 1/4"
 Pairs best with KNOB1909 or PULL1910

HAMMERED BRONZE



KNOBH913 37
 L: 1 3/8"
 W: 1 3/8"

ICE TEA



KNOBH108 11
 L: 1 7/16"
 W: 1 1/16"
 P: 1"
 B: 1/2"

D = Diameter
P = Projection (Hardware Depth)
L = Length
W = Width
B = Base
C/C = Center to Center

Installation screws included with each hardware piece.
 Breakoff screws available for purchase separately as BRKOFFSCREW, see page 157.
 Larger pulls may not be compatible with 5-piece drawer fronts on face frame openings of 9" wide or less.
 See Door Style section for 5-piece drawer front dimensions when specifying decorative hardware.
 For color images of decorative hardware, see company web site.

SATIN NICKEL



KNOBT002 42
 C/C: 1 1/4"
 L: 2"
 W: 3/8"
 P: 1 1/2"
 Pairs best with PULLT001



PULLT001 28
 C/C: 7"
 L: 8"
 W: 3/8"
 P: 1 1/2"
 Pairs best with KNOBT002



PULLH120 27
 C/C: 160mm
 L: 7 1/8"
 W: 3/4"
 P: 1"
 Pairs best with PULLH122



PULLH122 50
 C/C: 12"
 L: 12 3/4"
 W: 7/8"
 P: 1 3/16"
 Pairs best with PULLH120

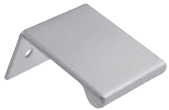

PULLH105 33
 C/C: 1"
 L: 1 3/4"
 W: 1"
 P: 1 3/4"
 Pairs best with PULLH106 or PULLH107



PULLH106 46
 C/C: 160mm
 L: 7"
 W: 1"
 P: 1 3/4"
 Pairs best with PULLH105 or PULLH107



PULLH107 74
 C/C: 12"
 L: 13"
 W: 1"
 P: 1 13/16"
 Pairs best with PULLH105 or PULLH106

D = Diameter
P = Projection (Hardware Depth)
L = Length
W = Width
B = Base
C/C = Center to Center

Installation screws included with each hardware piece.
 Breakoff screws available for purchase separately as BRKOFFSCREW, see page 157.
 Larger pulls may not be compatible with 5-piece drawer fronts on face frame openings of 9" wide or less.
 See Door Style section for 5-piece drawer front dimensions when specifying decorative hardware.
 For color images of decorative hardware, see company web site.

SATIN NICKEL
 (cont'd)



KNOB1420 18
 D: 1 1/4"
 P: 1 1/8"



KNOBH118 16
 L: 1 5/16"
 W: 1 5/16"
 P: 1 3/16"
 B: 7/8"



KNOBM549 17
 D: 7/8"
 P: 1"



PULLH50 49
 C/C: 5"
 L: 5"
 W: 5/16"
 P: 1 1/4"



PULLH63 40
 C/C: 96mm
 L: 4 1/8"
 W: 1/2"
 P: 1 1/16"



PULLH957 27
 C/C: 3"
 L: 4 1/4"
 W: 1 1/2"
 P: 11/16"



PULLM381 23
 C/C: 5 1/16"
 L: 6"
 W: 1/2"
 P: 1 1/16"



PULLM430 27
 C/C: 5 1/16"
 L: 7"
 W: 15/32"
 P: 1 7/16"



PULLM570 22
 C/C: 5 1/16"
 L: 5 7/8"
 W: 1/2"
 P: 1 3/16"

SILVER STONE



KNOBH127
D: 1 1/2"
P: 1"
B: 7/8"

18



PULLH128
C/C: 160mm
L: 7 1/2"
W: 3/4"
P: 1 1/16"

28

STAINLESS STEEL



KNOBH135
L: 1 3/4"
W: 1/2"
P: 1 1/8"
B: 1/2"
Pairs best with PULLH129 or PULLH131

14



PULLH129
C/C: 128mm
L: 6 3/8"
W: 7/16"
P: 1 1/8"
Pairs best with KNOBH135 or PULLH131

16



PULLH131
C/C: 224mm
L: 10"
W: 1/2"
P: 1 3/8"
Pairs best with KNOBH135 or PULLH129

25



PULLH141
C/C: 128mm
L: 7 3/8"
W: 1/2"
P: 1 1/4"
Pairs best with PULLH142 or PULLH143

15

STAINLESS STEEL (cont'd)

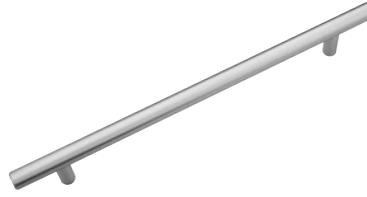

PULLH142
C/C: 192mm
L: 9 15/16"
W: 1/2"
P: 1 1/4"
Pairs best with PULLH141 or PULLH143

17



PULLH143
C/C: 384mm
L: 17 1/2"
W: 1/2"
P: 1 1/4"
Pairs best with PULLH141 or PULLH142

26

TUSCAN BRONZE



KNOBH117
L: 1 5/16"
W: 1 5/16"
P: 1 3/16"
B: 7/8"
Pairs best with PULLH119

16



PULLH119
C/C: 160mm
L: 7 1/8"
W: 3/4"
P: 1"
Pairs best with KNOBH117

40



KNOBH1013
D: 1 1/4"
P: 1 1/16"

33

D = Diameter
P = Projection (Hardware Depth)
L = Length
W = Width
B = Base
C/C = Center to Center

Installation screws included with each hardware piece.
Breakoff screws available for purchase separately as BRKOFFSCREW, see page 157.
Larger pulls may not be compatible with 5-piece drawer fronts on face frame openings of 9" wide or less.
See Door Style section for 5-piece drawer front dimensions when specifying decorative hardware.
For color images of decorative hardware, see company web site.

DESCRIPTION	MODEL	PRICE
DECORATIVE HARDWARE - TOUCH LATCH		

TOUCH LATCH

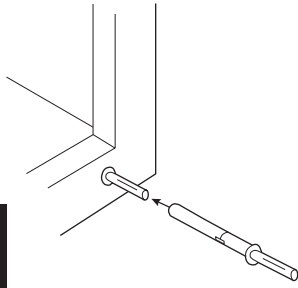

TOUHLATCH

35

- Nylon gray mechanism with bumper tip.
- Face frame will need to be field drilled for insertion of the TOUCHLATCH, requires 25/64" (10mm) drill bit.
- Can be field adjusted for door gap depth, no tools required.
- For use on full overlay door styles only.
- Requires a soft touch to open the door, and door must be pushed closed to reset the TOUCHLATCH mechanism.
- Only for use on hinged doors, and can be used without decorative hardware. Not compatible with non-hinged doors. For drawers, pull-outs, and other non-compatible cabinets, PULLH105 and PULLH106 are recommended (see page 148).

150

DECORATIVE HARDWARE

D = Diameter
P = Projection (Hardware Depth)
L = Length
W = Width
B = Base
C/C = Center to Center

Installation screws included with each hardware piece.
 Breakoff screws available for purchase separately as BRKOFFSCREW, see page 157.
 Larger pulls may not be compatible with 5-piece drawer fronts on face frame openings of 9" wide or less.
 See Door Style section for 5-piece drawer front dimensions when specifying decorative hardware.
 For color images of decorative hardware, see company web site.

TABLE OF CONTENTS – ACCESSORIES

Cabinet Accessories151
 Roll Tray Kits154
 Stain, Paint, & Touch-up Tools154
 Guide Kits and Parts155
 Hinges156
 Doors, Drawer Fronts, and Drawers157
 Miscellaneous Parts157

DESCRIPTION MODEL PRICE

CABINET ACCESSORIES

CABMAT™



CABMAT30	300
CABMAT33	300
CABMAT36	300

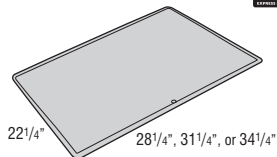

- Designed to capture spills and is removable for cleaning.
- Not trimmable. Can also be used in wider cabinets but will create a small void of unprotected area along the end panels.

CABMAT™ VANITY



CABMATV24	300
CABMATV30	300
CABMATV36	300

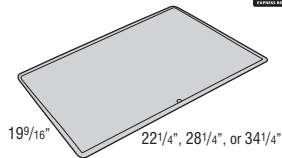

- Designed to capture spills and is removable for cleaning.
- Not trimmable. Can also be used in wider cabinets but will create a small void of unprotected area along the end panels.

DESCRIPTION MODEL PRICE

COOKING UTENSIL DIVIDER



CUDD24	276
CUDD30	308
CUDD36	341

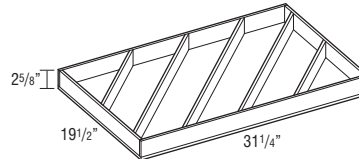
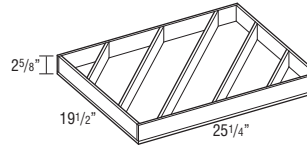
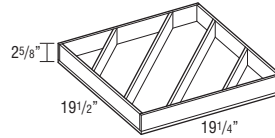

Model	Application
CUDD24	24" Base
CUDD30	30" Base
CUDD36	36" Base

- Pre-assembled natural wood drawer insert (does not fit roll trays).
- Available in 24" deep cabinets only.
- Only compatible with soft-close wood drawers.

CUTLERY INSERT WOOD ORGANIZER



CIW15	192
CIW18	205
CIW21	266
CIW24	285

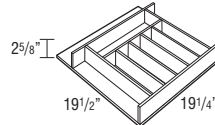
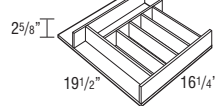
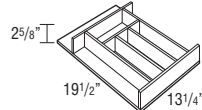
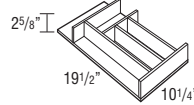

Model	Application
CIW15	15" Base
CIW18	18" Base
CIW21	21" Base
CIW24	24" Base

- Pre-assembled natural wood drawer insert.
- Place a cabinet with a CIW next to the dishwasher for convenience.

DESCRIPTION MODEL PRICE

WOOD TIERED CUTLERY DIVIDER DRAWER, 15", 18", 21", and 24"



WTCD15	512
WTCD18	532
WTCD21	554
WTCD24	571

Model	Application
WTCD15	15" Base
WTCD18	18" Base
WTCD21	21" Base
WTCD24	24" Base

- Replaces standard drawer. Uses existing cabinet member drawer hardware.
- Requires field installation of drawer front.
- For use with 24" deep cabinets only.
- Exterior WTCD drawer box height is 3 3/4", interior height of top and bottom tier is 1 3/8".
- Top divider slides front-to-back.

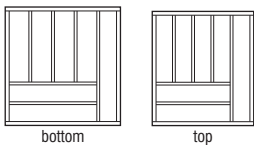
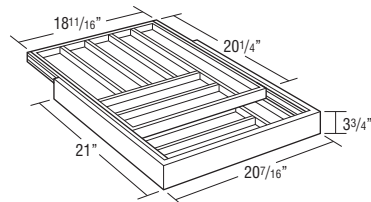
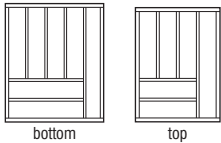
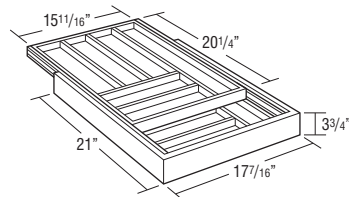
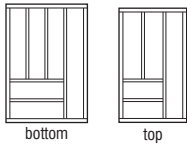
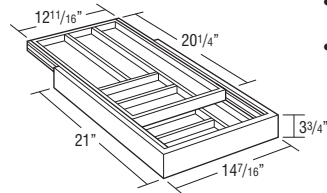
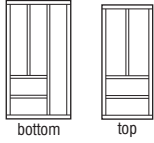
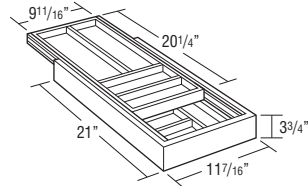

DESCRIPTION MODEL PRICE

STRAIGHT HEAT SHIELDS



STRHEATSHIELD	115
STRTHSHIELDSS	136

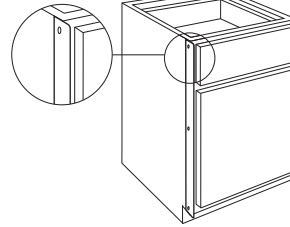
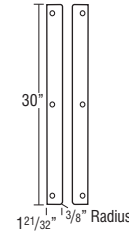

- STRHEATSHIELD is a pair of 1/16" thick, white powder coated metal shields.
- STRTHSHIELDSS is a pair of 1/16" thick, stainless steel metal shields.
- Heat Shield is used to deflect heat from self-cleaning ovens away from cabinet doors and drawer fronts.
- Requires an additional 1/8" to be added to the manufacturer's recommended space requirement.
- Installs on the side of the face frame of each cabinet adjacent to the oven.

OVEN INSTALLATION KIT



OCINSTALKIT	62
-------------	----

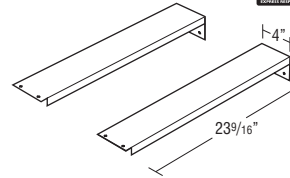

- Recommended for supporting built-in appliances such as ovens, microwaves, and warming drawers. Refer to appliance manufacturer specifications for installation requirements.
- Weight limit is 400 lbs. per pair.

PEGGED DISH ORGANIZER



PDO (8 Pegs & Board)	397
PDOPOSTS (4 Pegs)	101

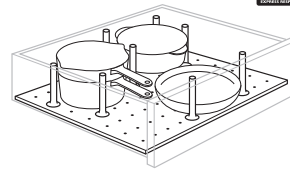

- Recommended for use in 36" wide Two Drawer Base (2DB) and Three Drawer Base (3DB) cabinets, trimmable for cabinets less than 36" wide.
- Not recommended for use in roll trays.
- Pegged Board is 19/32" thick.
- 29 15/16" x 19 1/2".
- Pegs are 6" high.

DESCRIPTION MODEL PRICE

SPICE RACK PULL-DOWN



SPD18 239

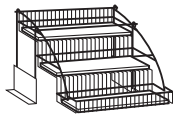

- Spice Rack Pull-down dimensions: 8 15/16" high x 14 13/16" wide x 10 5/16" deep.
- Spice Rack Pull-down requires 3 3/4" below the bottom edge of the cabinet and 9 1/4" in front of the cabinet to be fully extended.
- Maximum Weight Capacity: 15 lbs.
- Must be installed on the floor of the cabinet. Cannot be installed on an adjustable shelf.

TILT-OUT TRAYS, PLASTIC



TOT15 108

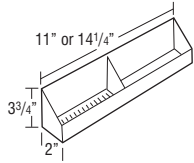

TOT18 114

- Kit includes two white plastic trays and one pair of tilt-out hinges that attaches to the inside of the false panel.
- One tilt-out tray per false panel on cabinets less than 30" wide and greater than 36" wide, two tilt-out trays attached to one false panel on 30"-36" wide cabinets.
- Clean using a mild soap and water. Avoid scalding water.
- Tilt-out trays are stain resistant, moisture resistant plastic to allow storage of sponges and other cleaning materials.

Model	Size	Application
TOT15	11" w x 2" d x 3 3/4" h	SB30, SB33
TOT18	14 1/4" w x 2" d x 3 3/4" h	SB21, SB24, SB27, SB36, SB39, SB42, SB45

TRAY DIVIDER KIT



CTDK 61

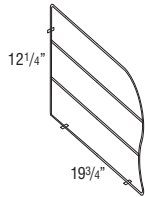

- CTDK: Includes 1 divider, 3 clips, and 3 screws.
- Tray divider is chrome wire.

DESCRIPTION MODEL PRICE

TRAY DIVIDER ROLL-OUT KIT



TDR012 323

TDR015 361

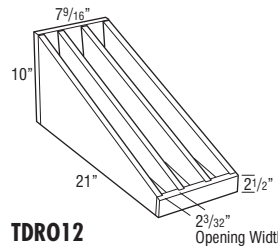

- TDR012: 2 removable dividers (3 compartments).
- TDR015: 3 removable dividers (4 compartments).
- Utilizes soft-close undermount guides.
- Installation hardware included.

TDR012

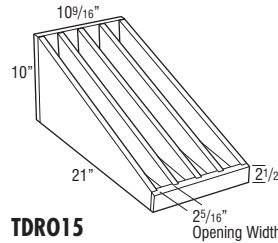

TDR015

WINE GLASS HOLDERS

WGH30 (7 slots) 292

WGH36 (8 slots) 356

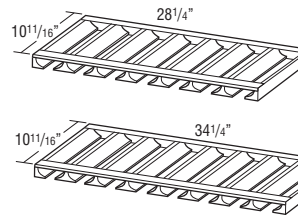

- Maximum wine glass base is 3" diameter.
- May be trimmed to fit smaller cabinets.
- Designed for installation under a wall cabinet (between end panels and behind face frame).
- Wine Glass Holder is finished.

Species Availability

Cherry	Maple	Oak	Laminate	Painted
•	•	•	Painted	•

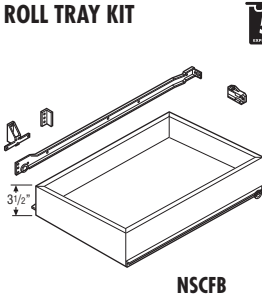
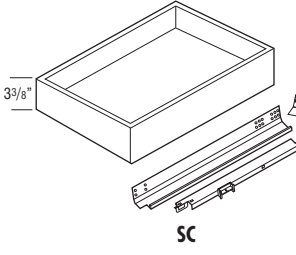

DESCRIPTION	MODEL	PRICE
ROLL TRAY KITS		
 <p>NSCFB</p>  <p>SC</p>	RT12	199
	RT15	199
	RT18	201
	RT21	207
	RT24	209
	RT27	210
	RT30	212
	RT33	214
	RT36	218
	RT39	198
	RT45	203
	RT12SC	231
	RT15SC	231
	RT18SC	233
	RT21SC	239
	RT24SC	241
	RT27SC	242
	RT30SC	244
	RT33SC	246
	RT36SC	250
RT39SC	233	
RT45SC	239	

Model	RT Width	RTSC Width	Application
RT12	7 9/16"	7 3/4"	B12, U12
RT15	10 9/16"	10 3/4"	B15, B15RT, U15
RT18	13 9/16"	13 3/4"	B18, B18RT, U18
RT21	16 9/16"	16 3/4"	B21, B21RT, U21, B42
RT24	19 9/16"	19 3/4"	B24, B24RT, U24, B48
RT27	22 9/16"	22 3/4"	B27, B27RT, U27
RT30	25 9/16"	25 3/4"	B30, B30RT, U30
RT33	28 9/16"	28 3/4"	B33, B33RT, U33
RT36	31 9/16"	31 3/4"	B36, B36RT, U36
RT39	15 1/16"	15 1/4"	B39
RT45	18 1/16"	18 1/4"	B45

- RT and RT_ _SC include roll tray, roll tray brackets, hardware, screws, and installation instructions.
- Exterior dimensions of roll tray are 21" deep x 3 3/8" tall (fits standard 24" deep cabinet).
- All kits will contain 1 roll tray. For 39" - 48" cabinets must order qty of 2 to achieve a roll tray in both cabinet openings.
- RT_ _ for use with NSCFB modification only. RT_ _ guides do not have soft-close feature. RT_ _SC guides have soft-close feature.
- For RT_ _ , Reduced Depth available to 18". For RT_ _SC, Reduced Depth available to 12".

Custom Modifications

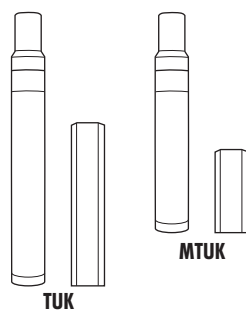
ID	RD
	•

DESCRIPTION	MODEL	PRICE	
STAIN, PAINT, & TOUCH-UP TOOLS			
 <p>TUK</p> <p>MTUK</p>	QUARTCOLOR	180	
	SSC	65	
	SSCCLEAR	65	
	<ul style="list-style-type: none"> • Wiping stains can be sprayed at low pressure. • Specify finish name and wood type when ordering stain. • QUARTCOLOR sold in quarts. • SSC is a 384 mL aerosol can available in Paints and laminate colors. • SSCCLEAR is a 384 mL aerosol can in clear. 		
	TOUCH-UP TOOLS		
	TUK	93	
	MTUK	48	
	GLAZEPEN	54	
	<ul style="list-style-type: none"> • Touch-up Kit includes a full size touch-up marker and a full size fill stick. No glaze pen included with glaze finishes. • Mini Touch-up Kit includes a small touch-up marker and a small fill stick. No glaze pen included with glaze finishes. • GLAZEPEN available in glaze colors only. • GLAZEPEN works on finished doors and does not require a separate top coat. 		
	PURE&SIMPLE™ CABINET CARE KIT		
	CABCLEANKIT	53	
	<ul style="list-style-type: none"> • PURE&SIMPLE™ Cabinet Care Kit includes one 16 ounce spray bottle of cleaning solution and a small microfiber cloth. • Safe for use on wood and laminate cabinet surfaces. 		

DESCRIPTION	MODEL	PRICE
-------------	-------	-------

GUIDE KITS AND PARTS

DRAWER GUIDE KITS



DGK21DDFX	296
DGK24DDFX	296

- Side-mount progressive full extension guide utilized on all drawers of DDFD cabinets.
- 125 lb. weight capacity per pair.
- Kit includes guide hardware for one drawer box (cabinet and drawer members, mounting rails, and screws).
- Dimension refers to cabinet depth.

DGKIT12SC	267
DGKIT15SC	267
DGKIT18SC	267
DGKIT21SC	267
DGKIT24SC	267

- Undermount full extension soft-close premium guide utilized on all standard height wood dovetail cabinet drawers and deep drawers.
- 75 lb. weight capacity per pair.
- Kit includes guide hardware for one drawer box (cabinets and drawer members, sockets and screws).
- Dimension refers to cabinet depth.

DGK18SM	41
DGK21SM	41
DGK24SM	41

- SM—Furniture board drawer side-mount guide used on drawers with NSCFB mod.
- 3/4" extension.
- 75 lb. weight capacity per pair.
- Kit includes guide hardware for one drawer box (cabinets and drawer members, sockets and screws)
- Dimension refers to cabinet depth.

DGKIT12RTSC	267
DGKIT15RTSC	267
DGKIT18RTSC	267
DGKIT21RTSC	267
DGKIT24RTSC	267

- Undermount full extension soft-close premium guide utilized on roll trays.
- 75 lb. weight capacity per pair.
- Kit includes guide hardware for one roll tray (cabinets and drawer members, sockets and screws).
- Dimension refers to cabinet depth.

DGK18RT	41
DGK21RT	41
DGK24RT	41

- Side-mount guide used on roll trays with NSCFB mod.
- 3/4 extension.
- 75 lb. weight capacity per pair.
- Kit includes guide hardware for one roll tray (cabinets and drawer members, sockets and screws).
- Dimension refers to cabinet depth.

DESCRIPTION	MODEL	PRICE
-------------	-------	-------

DRAWER GUIDE BACK SOCKETS



BKSOCKET-SCSPC	51
BKSOCKET-SC	51
BKSOCKET-RTSC	51
DGK-BKSCKT-24SM	51

- BKSOCKET-SCSPC used with soft-close drawer guides and roll tray guides (12" deep).
- BKSOCKET-SC used with soft-close drawer guides (15"-24" deep).
- BKSOCKET-RTSC used with soft-close roll tray guides (15"-24" deep).
- DGK-BKSCKT-24SM used with side-mount drawer guides (NSCFB mod).
- Sold in pairs.

DRAWER GUIDE BOX LOCKS



DGBOXLOCKSPC	43
DGBOXLOCKB9SPC	43
DGBOXLOCKSC	43
DGBOXLOCKSCB9	43

- DGBOXLOCKSPC used with soft-close drawer guides (12" deep).
- DGBOXLOCKB9SPC used with soft-close drawer guides on cabinets with drawers with a face frame opening of 7 1/2" or less (12" deep).
- DGBOXLOCKSC used with soft-close drawer guides (15"-24" deep).
- DGBOXLOCKSCB9 used with soft-close drawer guides on cabinets with drawers with a face frame opening of 7 1/2" or less (15"-24" deep).
- Sold in pairs.

FALSE PANEL CLIP

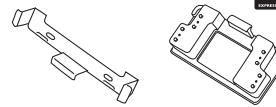

FALSEPNLCLIP50	9 /pair
PFALSEPNLCLIP50	9 /pair

- Clips come in pairs of two.
- Use to secure false front on sink base.

ROLL TRAY PLUG IN BRACKET

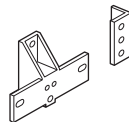



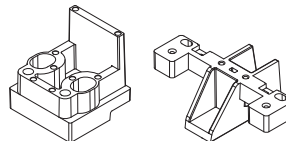



RTBK



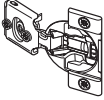
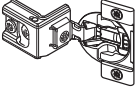

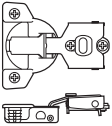
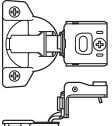
RTBKXSP

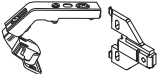
RTBK	52
RTBKXSP	50

- For use with roll tray hardware to prevent interference with door hinges. Also included in roll tray hardware kit.
- RTBK for use with roll trays with NSCFB mod.
- RTBKXSP for use with standard roll trays.
- Includes four end panel brackets, two vertical stile brackets, and screws.

DESCRIPTION	MODEL	PRICE
HINGES		
 	38NPOHINGE	32
	<ul style="list-style-type: none"> • Integrated soft-close. • 6-way adjustable. • 1/2" partial overlay 107° hinge. • For use on all partial overlay cabinets not specified by other hinges. • For use on full overlay styles: Wall and Base Transition Cabinets, Diagonal Wall and Base Cabinets, and 36" Angled Corner Sink Bases and Fronts. • Sold in pairs. 	
	38CFOHINGE	32
	<ul style="list-style-type: none"> • Integrated soft-close. • 6-way adjustable. • Full overlay 107° hinge. • For use on all full overlay cabinets not specified by other hinges. • Sold in pairs. 	
	38BFOHINGE	32
	<ul style="list-style-type: none"> • Integrated soft-close. • 4-way adjustable. • Full overlay face-mount 107° hinge. • For use on OSB, OCD and OMC, and 36"-42" high WBMW cabinets. • Sold in pairs. 	
	2925HINGE	23
	<ul style="list-style-type: none"> • 6-way adjustable. • 1/2" partial overlay 107° hinge • For use on full overlay styles with NSCH modification: Wall and Base Transition Cabinets, Diagonal Wall and Base Cabinets, and 36" Angled Corner Sink Bases and Fronts. • Sold in pairs. 	
	2933HINGE	23
	<ul style="list-style-type: none"> • 6-way adjustable. • Full overlay 107° hinge. • For use on all full overlay cabinets with NSCH modification and not specified by other hinges. • Sold in pairs. 	
	1351HINGE	12
	<ul style="list-style-type: none"> • 4-way adjustable. • Full overlay face-mount 107° hinge. • For use on OSB, OCD and OMC, and 36"-42" high WBMW cabinets with NSCH modification. • Sold in pairs. 	
	32049HINGE	83
	<ul style="list-style-type: none"> • 90° Corner Self-closing Center Hinge • For use as center hinge on BLS, SLS, BER, and ER cabinets. • Sold in pairs. 	
	942HINGE	71
	<ul style="list-style-type: none"> • 170° Hinge • For use on BSC, BLS, SLS, BER, and ER cabinets. • Sold in pairs. 	
	7299HINGE	13
	<ul style="list-style-type: none"> • Mirror hinge. • For use on TV and MC cabinets. • Sold in pairs. 	

DESCRIPTION	MODEL	PRICE
	HINGERESCLIP	13
	<ul style="list-style-type: none"> • For use in applications with cabinets installed at varying depths to prevent the door damage caused by opening into an adjacent cabinet. • Restricts hinges to 86° opening capability. • Works only with the 38NPOHINGE and 38CFOHINGE. • Not recommended for cabinets with roll trays specified in partial overlay styles. • Sold in pairs. 	
	HINGESHIMS	18
	<ul style="list-style-type: none"> • Install between the face frame and hinge to allow additional adjustment of doors. Can be used to reduce gap between butt doors. • Each shim is 1/32" thick and can be stacked to achieve desired overlay reduction. • Pack of 5 metal shims. • Compatible with all hinges except face-mount. 	

DESCRIPTION	MODEL	PRICE
DOORS, DRAWER FRONTS AND DRAWERS		

DOORS & DRAWER FRONTS



Standard Door Size, 18" High or Less	301
Standard Door Size, 21" to 30" High	377
Standard Door Size, 33" or Higher	530
Standard Door Size, No Hinge Route, 18" High or Less	301
Standard Door Size, No Hinge Route, 21" to 30" High	377
Standard Door Size, No Hinge Route, 33" or Higher	530
Any Drawer Front Only	139

- All applicable modification and premium finish upcharges will apply.
- Door heights are based on full overlay for equivalent applications.
- Backs of "NO HINGE ROUTE" doors may have identification marks, be unfinished, and have 3/16" diameter holes used during finish processing. For these reasons, these doors are not suitable for use as cabinet doors.

DRAWERS



Complete Drawer	222
Drawer Box Only	198

- All applicable modification and premium finish upcharges will apply.
- Complete Drawer and Drawer Box Only do not include drawer guides. They must be ordered separately.

MISCELLANEOUS PARTS

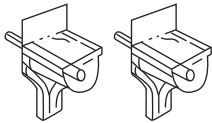

SHELFPEGS



BRKOFFSCREW (pkg. 25)	6
INSTALLSCR4 (pkg. 4)	5
INSTALLSCREWS (pkg. 100)	20
RETCLIP250BAG	20
RETCLIP259BAG	20
BUMPERPADS (pkg. 25)	8
SHELFPEGS (pkg. 24)	12

- BRKOFFSCREW is a pack of 25 breakaway screws for use with decorative hardware pulls and knobs.
- INSTALLSCR4 and INSTALLSCREWS are screws for cabinet installation through the cabinet back to the wall studs (includes a pack of 4 or 100).
- RETCLIP250BAG: 6 retainer clips for use with glass inserts in mullion and cut-for-glass doors. For use on all styles except laminate doors.
- RETCLIP259BAG: 6 retainer clips and a variety of rubber feet for use with glass inserts in mullion and cut-for-glass doors. For use on all laminate doors only.
- SHELFPEGS are 3mm steel pins with clear plastic shoulders.

Description	Code	Page Number
All-plywood Construction	APW	3
Angled Corner Sinks	ACS	72
Angled Fluted/Plain Fillers	BLVDF	125
Arched Valance	AV	140
Art Corbel 9"	CORBELART9	144
Arts & Crafts Bracket	JBRACKETART	144
Artisan Straight Wood Hood	WHAS	57
Asymmetrical Base Easy Reach	BER	77
Asymmetrical Easy Reach Wall Corners	ER	50
Asymmetrical Super Susans	SLS	77
Authentic Ends	AUTH	6
Baseboard Moulding	BBM	138
Base Box Column Pull-out	BBCPO	82
Base Built-in Microwave Cabinet w/Drawer	BBMWD	83
Base Cabinets	B	64
Base Cabinets Four Drawer	4DB	80
Base Cabinets Four Drawer w/Wood Tiered Cutlery Divider Drawer	4DB..WTCD	80
Base Cabinets Three Drawer	3DB	79
Base Cabinets Three Drawer w/Wood Tiered Cutlery Divider Drawer	3DB..WTCD	79
Base Cabinets Two Drawer	2DB	78
Base Cabinets Two Drawer w/Drop-in Range	2DB..DR	79
Base Cabinets Two Drawer w/Roll Tray	2DB..RT	79
Base Cabinet w/Mixer Shelf	B..FHMIXSC	68
Base Cabinets w/Full Height Doors	B..FH	65
Base Corner Cabinets	BC	75
Base Corner Peninsula	BCP	84
Base Corner Peninsula, Full Height Door	BCP..FH	84
Base Drawer Cabinets	DB	78-80
Base Drop-in Range Cabinet	B36DR	83
Base Easy Reach	BER	76
Base End Cabinet	BEC	78
Base Full Height w/Tray Divider	TD..FH	68
Base Lazy Susan Corner w/Center Hinge Door	BLS	75
Base Microwave Cabinets w/Deep Drawer	BMWD..DD	84
Base Microwave Cabinets w/Drawer	BMWD	84
Base Ovens	BO	83
Base Pantry Pull-outs	BPP	81
Base Transition Cabinets	BTC	78
Base Utensil Pantry Pull-out	BUPP	82
Base Utensil Pantry Pull-out w/Knife Block	BUPPKB	82
Base Wastebasket	BWB	80
Base Wastebasket Full Height	BWB..FH	81
Base Wine Cubby	BWC	81
Baseboard Moulding	BBM	138
Baseboard - Shaker	BBMSH	138
Bases w/Roll-out Tray Divider	B..TDRO	67
Bases w/Roll Trays	B..RT	66-67
Bases w/Tray Dividers	TD	67
Bookcases Tall	TBC	107
Bookcases Wall	WFBC	106
Box Column Fillers (Wall, Base, Tall)	BCF	125
Cabinet Box Only	CBO	8
Cabinet Case Only	CCO	8
Cabinet False Panel	CFP	8
Cabinet Front Only	CFNTO	14
Cabinet Panel Edge Moulding	CPE	137
Cabinet Panel Edge Square	CPES	138
Cabinet w/No Door, w/Drawer	CND	8
CabMat™	CABMAT	151
CabMat™ Vanity	CABMATV	151
Canopy Square Wood Hood	WHCS	60
Cap Moulding	CAPM	138
Classic Square Wood Hood	WHS	58

Description	Code	Page Number
Classic Tall Crown Moulding	CLTCROWN	135
Classic Wood Hood Chimney	WHC, WHCT	59
Cooking Utensil Divider	CUDD	151
Corner Door Cabinets	CD	53
Countertop Edge Moulding (Traditional)	TCM	137
Country Sink Bases	CNTYSB	73-74
Country Sink Bases w/CabMat™	CNTYSB..CM	73
Cove Crown Moulding	COVECROWN	135
Craftsman Foot	JCRAFTFOOT	143
Craftsman Straight Wood Hood	WHCFS	57
Cross Grain Veneer Back Skin 1/4" Panels	BP..CRSGR	127
Cut-for-glass Doors	CG	15
Cutlery Dividers	CIW, WTCD	152
Decorative Door Panel Kits, Base End	BEDSD	131
Decorative Door Panel Kits, Tall End	TED	131
Decorative Door Panel Kits, Wall End	WED	131
Desk Door Drawer Bases	DDO	108
Desk Double File Drawer Bases	DDFD	108
Desk File Drawer Bases	DFD	108
Desk Three Drawer Base	3DB	108
Diagonal Base Cabinet w/Full Height Door	DAB..FS	76
Diagonal Base Cabinet w/Full Height Door & Super Lazy Susan	DAB..SLS	76
Diagonal Wall Cabinets	DW	47
Diagonal Wall Cabinets w/Lazy Susan	DW..S	49
Drawer Front Flat 5-piece	DFF5PC	4
Drawer Guide Back Sockets	BKSOCKET	155
Drawer Guide Box Locks	DGBOXLOCK	155
Drawer Guide Kits	DGK	155
Easy Reach Wall Corner Cabinets	ER	50
End Panel Skins/Base	BEPS	126
End Panel Skins/Tall	TEPS	127
End Panel Skins/Wall	WEPS	126
End Panels/Base	BEP	128
End Panels/Lazy Susan	BLSBEP	128
End Panels/Tall	TEP	128
End Panels, Wall	WEP	128
English Island Column	ENGISLCOLUMN	140
Estate Leg, Small	JESTATELEGS	140
Exterior Shelf	ES	145
False Panel Clips	FALSEPNLCLIP50, PPALSEPNLCLIP50	155
Fillers	F	123
Finished Back Skins	BP	127
Finished Ends	FB	6
Flat Scribe Moulding	SM	137
Floating Shelves	FS	144
Flush Toekick	.FTK	11
Full Depth Shelf	.FD	10
Full Depth Shelving	SK	145
Furniture Drawer Window Bench	FDWB	110
Furniture Drawers	FD	109
Furniture Finished Plywood End Panels	.FPFB	6
Furniture Valance	FV	140
Glass Shelf Kits	JGSK	145
Hardware — Decorative Knobs and Pulls	KNOB, PULL	146-150
Heat Shields	STRTHEATSHIELD, STRTHSHIELDSS	152
Hinge Angle Restriction Clip	HNGRESCLIP	156
Hinge Shim	HINGESHIM	156
Hinges	HINGE	156
Increased Depth	ID	9
Insert Crown	INSCROWN	135
Inside Corner Moulding	ICM	139
Installed Roll Tray	RT	10

Description	Code	Page Number
Interior Skin	BP4896LAM	127
Island Leg	ISLEG	141
Island Leg Tapered	ISLETPRD	142
Large Corbel	LGCORBEL	144
Large Shaker Crown Moulding	LSHAKER	135
Large Straight Angle Crown Moulding	LSACROWN	135
Library Moulding	LBRM	137
Light Baffle Moulding	LB	139
Light Rail Moulding	LRM	139
Lille Foot	LIFOOT	143
Linen Tall Cabinet w/Drawer	LTD	121
Linen Tall Cabinet w/Drawer and Removable Hamper	L	121
Matching Interior Plywood	MIP	7
Medicine Cabinets (Single)	MC	122
Medium Straight Angle Crown Moulding	MSACROWN	135
Metro Island Column	METISLCOLUMN	141
Mirror Frame Moulding	WMF	137
Miscellaneous Parts	BRKOFFSCREW, BUMPERPADS, INSTALLSCR, INSTALLSCREWS, RETCLIP.BAG, SHELFPEGS	157
Mission Corbel 9"	CORBELMS9	144
Mission Leg	DLEMISSION	141
Mullion Doors	MD	16
Non Soft-close Door Hinges	NSCH	5
Non Soft-close Guides & Furniture Board Drawers and Roll Trays	NSCFB	5
Ogee Edge Moulding	OGEEEM	137
Old World Corbel 5"	CORBELOWD5	144
Outside Corner 135° Moulding	OC135	139
Outside Corner Moulding	OCM	139
Oven Cabinets Double	OCD	99
Oven Cabinets Double w/Deep Drawer	OCD..DD	101
Oven Cabinets Single	OSB	97
Oven Installation Kit	OCINSTALLKIT	152
Oven Microwave Cabinets w/Deep Drawer	OMC..DD	103
Overlay Fillers	OL	124
Overlay Fillers w/Modified Full Overlay	OL3..MFO, OL6..MFO	124
Panels w/Filler Attached	BEPF, TEP	129
Pegged Dish Organizer	PDO, PDOPOSTS	152
Peninsula	P	14
Plywood Ends	PLE	3
PURE&SIMPLE™ Cabinet Care Kit	CABCLEANKIT	154
Quarter Round Moulding	QRM	139
Raised Panel Arched Valance	JRPV	140
Recessed Island Toekick	RECTKALL	13
Recessed Toekick on Back	RECTKBK	13
Recessed Toekick on Side	RECTKL, RECTKR	13
Reduced Depth	RD	9
Removable Vanity Wall Sink	RVWS	88
Roll Tray Kits	RT, RT..SC	154
Roll Tray Plug In Bracket	.RTBK, RTBKXSXC	155
Scroll Corbel 9"	CORBELCR9	144
Shaker Crown Moulding	SHKRCRM	135
Shiplap Tapered Wood Hood	JWSHIPT	59
Shiplap Wood Hood Chimney	JWSHIPC	59
Shoe Moulding — Convex Inside Corner	SHM	139
Signature Mantel Wood Hood	WHSGM	58
Simple Tapered Wood Hood	WHSMT	60
Simple Wood Hood Chimney	WHSMC	60
Single Bead Edge Moulding	SBE	137
Single Door Medicine Cabinet	MC	122
Sink Base SuperCabinet™ w/Tilt-out Trays	SB..STS	71

Description	Code	Page Number
Sink Base SuperCabinet™ w/Tilt-out Trays and CabMat™	SB..STSCM	71
Sink Base w/CabMat™	SB..CM	69
Sink Base w/Tilt-out Trays and CabMat™	SB..STCM	70
Sink Bases	SB	68-69
Sink Bases w/Tilt-out Trays	SB..ST	69-70
Small Cove Crown Moulding	SMCOVECROWN	135
Small Light Rail Moulding	SMLR	139
Small Scribe Moulding	SCRIBES	137
Snack Bar Support, 11 1/4"	SBS	144
Soffit Filler Moulding	SFM	137
Soffit Trim Moulding	TSTM	138
Solid-wood Crown Moulding	SWCRM	136
Solid-wood Large Crown Moulding	SWLCRM	136
Solid-wood Tall Crown Moulding	SWTCRM	136
Solid-wood Victorian Crown Moulding	SWVCRM	136
Spice Rack Pull-down	SPD	153
Spool Decorative Leg	SPLG	142
Square Flat Panel Wood Hood	WHSFP	58
Square Island Leg	JSQISLLEG	141
Stack Moulding Kits	STKMLD	132-134
Stacked Diagonal Wall Cabinets	STDW	48
Stacked Wall Cabinets	STW	43
Stain & Paint	QUARTCOLOR, SSC	154
Starter Moulding	.STR8	137
Starter Moulding, Shaker	.STRS	137
Straight Angle Crown Moulding	SACROWN	135
Straight Batten Wood Hood	WHSBATTEN	61
Straight Valance	VV	140
Super Susans	SLS	77
SuperCabinet™, 30"	BSC30PR, BSC30RP	66
SuperCabinet™, 36"	BSC36PRP	66
Tall Crown Moulding	MTCROWN	135
Tapered Leg	TAPLG	143
Tapered Wood Hoods	TWH	61
Three Drawer Bases	3DB	79
Tilt-out Trays, Plastic	TOT	153
Toeboards	TB	138
Toekick Cap	TKC	138
Toekick Tulip Foot	TKTLFOOT	143
Touch Latch	TOUCHLATCH	150
Touch-up Tools	TUK, MTUK, GLAZEPEN	154
Tray Divider Kit	.CTDK	153
Tray Divider Roll-out Kit	TDRO	153
Triple Bead Edge Moulding	TBEM	138
Triple Bead Pilaster Moulding	TBP	138
Tri-view Medicine Cabinet	TV	122
Tulip Foot	TLFOOT	143
Under Counter Drawers	UCD, UCDS	109, 120
Under Counter Drawer, Trimmable	UCDT	109, 120
Universal Access Base Cabinet	B	86
Universal Access Base Microwave Cabinets w/Deep Drawer	BMWD....DD	88
Universal Access Sink Base	SB	86
Universal Access Sink Base, Removable	UASBRF	86-87
Universal Access Super Lazy Susan	SLS	87
Universal Access Three Drawer Base Cabinet	3DB	88
Utility Cabinets	U	90-94
Utility Cabinets w/Roll Trays	U..RT	95-96
Valley Forge Moulding	VFR	139
Vanity Desk Legs	VDL	130
Vanity Door Drawer Bases	VB	113
Vanity Drawer Bases	VDB	114
Vanity Four Drawer Bases	4VDB	114
Vanity Mirror	VM	122

Description	Code	Page Number
Vanity Sink Bases w/False Panel	VSB	112-113
Vanity Sink Drawer Bases	2VSD	115
Vanity Sink Drawer Bases w/False Panel	VSD	117
Vanity Sink Drawer Bases w/Six Drawers & False Panel	VSD..FP	119
Vanity Sink Three Drawer Bases	VSDS	119
Vanity Sink Wide Drawer Base w/False Panels	VSWD	116
Vanity Wall Cabinets	W	121
Vanity Wall Cubby	.VWC	121
Vanity Wall Mirror Cabinets	VWM	122
Vanity Wall Sink	VWS	88
Void Toekick	VTK	12
Wall Appliance Garage	WAGD	53
Wall Box Column Pull-outs	WBCPO	54
Wall Built-in Microwave Cabinet	WBMW	52
Wall Corner Cabinets	WC	46-47
Wall Double Door Cabinets	W	32-42
Wall End Cabinets	WEC	51
Wall Message Center	WMC	56
Wall Microwave Cabinets	MW	51
Wall Microwave Double Door Cabinets	WMW	52
Wall Organizers	WORG	56
Wall Quarter Round End Shelves	WQRES	51
Wall Refrigerator Cabinets	W	33-39
Wall Single Door Cabinets	W	32-41
Wall Spice Pull-out	WSP	54
Wall Three Drawer Cabinets	W3D	45
Wall Top Hinge Cabinets	WTH	33-37
Wall Cube Horizontal	WCH	55
Wall Wine Racks	WNR	55
Waterfall Wood Hood	WHWF	57
Wine Glass Holders	WGH	153
Wine Storage Cabinet	WSC	55
Wood Hood Blower, 400 CFM	BLOWER400	62
Wood Hood Blower, 600 CFM	BLOWER600	62
Wood Hood Filter	FILTERCHAR	62
Wood Hood Interior Ductless Conversion Kit	CONVERSION	62
Wood V-grooved Beaded Skin 1/4" Panels	BP.VG	127

Code	Page Number
2DB	78
2DB..DR	79
2DB..RT	79
2VSD	115
3DB	79, 88, 108
3DB..WTCD	79
4DB	80
4DB..WTCD	80
4VDB	114
ACS	72
APW	3
AUTH	6
AV	140
B	64, 86
B..DR	83
B..FH	65
B..FHMIXSC	68
B..RT	66-67
B..TDRO	67
BBCPO	82
BBM	138
BBMSH	138
BBMWD	83
BC	75
BCF	125
BCP	84
BCP..FH	84
BEC	78
BEDSD	131
BEP	128
BEPF	129
BEPS	126
BER	77
BKSOCKET	155
BLOWER	62
BLS	75
BLSBEP	128
BLVDF	125
BMW	84
BMW..DD	84
BO	83
BP	127
BP..CRSGR	127
BP..VG	127
BP4896LAM	127
BPP	81
BRKOFFSCREW	157
BSC30PR	66
BSC30RP	66
BSC36PRP	66
BTC	78
BUMPERPADS	157
BUPP	82
BUPPKB	82
BWB	80
BWB..FH	81
BWC	81
CABCLEANKIT	154
CABMAT	151
CABMATV	151
CAPM	138
CBO	8
CCO	8
CD	53
CFNTO	14
CFP	8
CG	15
CIW	151
CLTCROWN	135
CND	8
CNTYSB	73-74
CNTYSB..CM	73
CONVERSION	62
CORBELART9	144
CORBELCR9	144
CORBELMIS9	144
CORBELOWD5	144

Code	Page Number
COVECROWN	135
CPE	137
CPES	138
CTDK	153
CUDD	151
DAB..FS	76
DAB..SLS	76
DB	78-80
DDFD	108
DDO	108
DFD	108
DFFSPC	4
DGBOXLOCK	155
DGK, DGKIT	155
DLEGMISION	141
DW	47
DW..S	49
ENGISLCOLUMN	140
ER	50
ES	145
F	123
FALSEPNCLIP50	155
FB	6
FD	10, 109
FDWB	110
FILTERCHAR	62
FPEB	6
FS	144
FTK	11
FV	140
GLAZEPEN	154
HINGE	156
HNGRESCLIP	156
HINGESHIM	156
ICM	139
ID	9
INSCROWN	135
INSTALLSCR, INSTALLSCREWS	157
ISLEG	141
ISLEGTPRD	142
JBRACKETART	144
JCRAFTFOOT	143
JESTATELEGS	140
JGSK	145
JRPV	140
JSQISLLEG	141
JWSHIPC	59
JWSHIPT	59
KNOB	146
L	121
LB	139
LBRM	137
LGCORBEL	144
LIFOOT	143
LRM	139
LSACROWN	135
LSHAKER	135
LTD	121
MC	122
MD	16
METISLCOLUMN	141
MIP	7
MSACROWN	135
MTCROWN	135
MTUK	154
MW	51
NSCFB	5
NSCH	5
OC135	139
OCD	99
OCD..DD	101
OCINSTALLKIT	152
OCM	139
OGEEM	137
OL	124
OL3..MFO	124
OL6..MFO	125
OMC..DD	103

Code	Page Number
OSB	97
P	14
PDO, PDOPOSTS	152
PFALSEPNCLIP50	155
PLE	3
PULL	146
QRM	139
QUARTCOLOR	154
RD	9
RECTKALL	13
RECTKBK	13
RECTKL, RECTKR	13
RETCLIP..BAG	157
RT	10
RT, RT..SC	154
RTBK, RTBKXSXC	155
RVWS	88
SACROWN	135
SB	68-69, 86
SB..CM	69
SB..ST	69-70
SB..STCM	70
SB..STS	71
SB..STSCM	71
SBE	137
SBS	144
SCRIBEB	137
SFM	137
SHELFPEDS	157
SHKRCRM	135
SHM	139
SK	145
SLS	77, 87
SM	137
SMCOVECROWN	135
SMLR	139
SPD	153
SPLG	142
SSC	154
STDW	48
STKMLD	132-134
STR8	137
STRS	137
STRTHEATSHIELD	152
STRTHSHIELDSS	152
STW	43
SWCRM	136
SWLCRM	136
SWTCRM	136
SWVCRM	136
TAPLG	143
TB	138
TBC	107
TBEM	138
TBP	138
TCM	137
TD	67
TD..FH	68
TDRO	153
TED	131
TEP	128
TEPS	127
TKC	138
TKTLFOOT	143
TLFOOT	143
TOT	153
TOUHLATCH	150
TSTM	138
TUK	154
TV	122
TWH	61
U	90-94
U..RT	95-96
UASBRF	86-87
UCD, UCDS, UCDD	109, 120
VB	113
VDB	114

Code	Page Number
VDL	130
VFR	139
VM	122
VSB	112-113
VSD	117
VSD..FP	119
VSDS	119
VSWD	116
VTK	12
VV	140
VWC	121
VWM	122
VWS	88
W	32-42, 121
W3D	45
WAGD	53
WBCPO	54
WBMW	52
WC	46-47
WCH	55
WEC	51
WED	131
WEP	128
WEPS	126
WFBC	106
WGH	153
WHC	59
WHAS	57
WHCF5	57
WHCS	60
WHCT	59
WHS	58
WHSBATTEN	61
WHSFP	58
WHSGM	58
WHSMC	60
WHSMT	60
WHWF	57
WMC	56
WMF	137
WMW	52
WNR	55
WORG	56
WQRES	51
WSC	55
WSP	54
WTCD	152
WTH	33-37



Dear Mid Continent® Pivot™ Customer,

Congratulations on your selection of Mid Continent Pivot cabinetry in a Painted Hardwood or Painted Hardwood with Glaze finish. Because of its unique characteristics, this finish is quite different from other cabinetry finishes you may be familiar with. Your satisfaction is important to Mid Continent Pivot, and we want you to fully understand the characteristics that make painted finishes so distinctive.

It is important to realize that the beauty of wood cabinetry comes from the natural qualities of wood itself. Mid Continent Pivot utilizes only select solid hardwoods and veneers. The beauty of these genuine woods lies in the variation of the grain. The textures of those natural grain patterns often remain visible with Painted Hardwood finishes and should be accepted as inherent characteristics when selecting painted cabinetry.

Seam lines and hairline cracking at stile, rail and panel joints are a normal characteristic of painted finishes and should not be considered a reason for product replacement. When ordering Painted Hardwood 5-piece styles, the door's center panel will be constructed of MDF material. Over time, there may be a slight color shift in the Painted Hardwood finish due to the continued exposure to natural and artificial light sources. We mention these characteristics because neither Mid Continent Pivot nor your Mid Continent Pivot dealer can be responsible for these conditions and variations.



Example of front joint separation



Example of front joint separation



Example of end joint separation

Accordingly, we ask that the following agreement be signed for Painted Hardwood Finish orders.

I have read the foregoing and find the characteristic variations of Painted Hardwood finish to be desirable. As such, I agree not to hold Mid Continent Pivot and/or the Mid Continent Pivot dealer listed below responsible in the event that these characteristics are later found by me to be less desirable than I had expected.

Customer Signature

Dealer Signature

Customer Name (please print)

Dealer Name (please print)

Dealer Purchase Order Number

POLICIES/INFORMATION

DISCONTINUED PRODUCT POLICY

60 days minimum notice to reps and customers announcing the discontinuation of a product line.

Product will no longer be available for order after the discontinuation date. Only warranty orders will be considered. Even with warranty orders we will have the option to replace customer's defective product with the same discontinued product they originally purchased, or replace all doors originally ordered with a current product that is similar in appearance.

EXPRESS RESPONSE™ PROGRAM - GUIDELINES

OUR COMMITMENT TO DESIGNERS AND CUSTOMERS

PURPOSE

The Express Response program is used to expedite orders when customers need product faster than normal lead-time to correct problems with an existing order. Below is an overview of the Express Response program and what you can expect from our commitment to superior service.

EXPRESS RESPONSE GUIDELINES

- Eligible orders must be associated with a previous order number.
- Lead time calculation is based on receipt of a clean order. Clean orders are orders in which all information is provided and accurate.
- There is no additional upcharge for Express Response.
- There are no cancellations or returns once an Express Response order is received.
- Due to the nature of Special Product Requests and appliance panels, they are excluded from Express Response and will be processed as a standard lead-time order.
- Express Response is available within the continental United States. Should Alaska, Hawaii or international shipments be required, customer service representatives are ready to assist by providing shipping information and determining lead times.

QUESTIONS?

Contact Customer Service for estimated lead times.

CABINET INSTALLATION INSTRUCTIONS

<https://www.masterbrandcabinets.com/installation>

HUMIDIFICATION

<https://www.masterbrandcabinets.com/humidification>

CABINET CARE AND CLEANING

<https://www.masterbrandcabinets.com/care-and-cleaning>

WARRANTY

Mid Continent® Pivot™ Series has a Limited Lifetime Warranty. For terms and conditions, please visit: <https://www.midcontinentcabinetry.com/get-started/love-your-space/warranty>.

WOOD DUST WARNING

When cutting, sanding, sawing, or shaping cabinets or wood products, you are likely to generate wood dust. For your own safety, we recommend that you wear a protective mask to prevent breathing wood dust. We also recommend eye protection to avoid injury by flying wood chips or sawdust during cabinet installation.

CERTIFICATIONS

ANSI A161.1

Our products meet or exceed the ANSI A161.1 performance and construction standards for kitchen and vanity cabinets as certified by ICC-ES (International Code Council Evaluation Service). Learn more at masterbrandcabinets.com/certifications.

TSCA TITLE VI

TSCA Title VI is a U.S. regulation that sets formaldehyde emissions standards for composite wood products, such as hardwood plywood, medium-density fiberboard, and particleboard, as well as products containing them, such as furniture. It requires composite wood products to be tested and certified by EPA-recognized third-party certifiers using specific methods. This federal regulation applies to all states and territories in the U.S. and is identical to the California Air Resources Board (CARB) rule. Learn more at masterbrandcabinets.com/certifications.

CARB COMPLIANCE - FORMALDEHYDE EMISSIONS

Mid Continent® Pivot™ Cabinetry is committed to offering solutions that meet or exceed air emissions rules and regulations. All composite wood products used in the construction of our cabinets, which includes end panels, bottoms, backs, shelves, toekicks and corner blocks, are compliant with emissions limits under EPA TSCA Title VI, CARB Phase 2 and HUD.

TERMS AND CONDITIONS

MID CONTINENT® PIVOT™ CABINETS LIFETIME LIMITED WARRANTY AND GENERAL INFORMATION



Prices and specifications in material, construction and design are subject to change without notice as conditions require, or as improvements are developed.

All orders are subject to credit approval.

To avoid errors, orders should be filled out on Mid Continent Pivot Cabinet forms.

All cabinets are manufactured to individual order and cannot be cancelled or changed after manufacturing has begun. Cycle ship orders cannot be changed after the cut-off date.

Returns will not be accepted without prior written authorization.

Mid Continent Pivot cabinets carry a Lifetime Limited Warranty. This limited warranty does not cover misuse*, improper storage, improper installation, labor costs or defects incurred during installation, storage or transportation. We reserve the right to repair or replace any defective material after field inspection by our representative. For complete warranty details, please refer to the Mid Continent Pivot Warranty Document.

A product count and inspection must be performed before signing the Bill of Lading. Shortage, obvious damage and occurrences of mishandling must be noted on the Bill of Lading before it is signed. Replacement orders must then be made with Mid Continent Pivot Customer Service. A signed Bill of Lading with no notations will indicate a complete and damage free shipment.

Sales are only to approved, authorized accounts.

Please make reference to the cabinet selection guide for information pertaining to characteristics of wood. This information will tell you the reactions that natural woods might develop under certain conditions after product is finished.

NOTES

NOTES



Enlightened.™ This is Mid Continent.™

Designer Photo Submission Call for Entries!

Don't miss out on the opportunity to have your design work featured on MasterBrand's website, social media, literature and beyond. We want to promote you by spotlighting your design talent.

Submission is simple via the Mid Continent Brand Portal on MasterBrand Connect.

TIPS AND REQUIREMENTS:

- A brief tutorial is available on Connect to navigate you through the simple submission tool.
- The submission form is within the Brand Portal section on Connect.
- A 'consent for use' form is required for each submission and is also available on Connect.
- Image quality, size, and theme will be taken into consideration for specific usability.
- Submission of media does not guarantee public use, but all submissions are reviewed for consideration and may be used internally.

HOW TO TAKE A BEAUTIFUL PHOTO

Taking a post worthy in-home photo with your mobile device can be simple! For helpful tips and tricks on lighting, exposure, and getting the right angle, visit MasterBrand Connect to view our valuable reference guide.



Share your Mid Continent designs
with us by scanning the QR code.



SIGNATURE™ SERIES

PIVOT™ SERIES

Share your design with us by tagging us on social with #MidContinentCabinetry.



Styles, product availability and construction may vary slightly from those shown in this book due to material availability and/or design evolution. Specifications are subject to change without notice. Customer service is available if your design requires verification of product availability and specifications.

Product photography and illustrations have been reproduced as accurately as printing technologies permit. To ensure highest satisfaction, we strongly recommend you view an actual sample for best color, wood grain and finish representation.

Mid Continent Cabinetry® has a Limited Lifetime Warranty.

For terms and conditions, please visit www.midcontinentcabinetry.com/warranty

Customer Service

Hours: Mon - Fri, 8:30 AM - 6:00 PM EST

Phone: 888-835-0268

Please reference Service Policies at masterbrandconnect.com

Designer ID #: _____

Customer Account #: _____

Sales Rep: _____



Part of the MasterBrand® Family

midcontinentcabinetry.com
#MidContinentCabinets
© 2024 MasterBrand Cabinets LLC
All rights reserved.